



Waterdichtarmatuur Waterproof Performer G4

- Krachtig assortiment waterdichte armaturen in specifiek "sealed for life"-ontwerp
- Eenvoudig installeren dankzij schroefloze snelsluiting
- Geleverd met vandaalbestendige RVS montageklemmen



## Specificaties

Artikelcode	Artikelomschrijving	Equivalent (W)	Vermogen (W)	Lumen	Efficiëntie (lm/W)	CCT (K)	Interne bedrading (mm <sup>2</sup> )	Max. diameter invoerkabel (mm)	Gewicht (kg/st)
<b>Statisch</b>									
711000007800	LEDWaterproof-P4 L1208-38W-840	TL 2x36W	38	5700	150	4000	3x2.5	7-11	1,08

## Artikel- en verpakkingsinformatie

Artikel			Doosverpakking			
Artikelcode	Artikelomschrijving	EU HS Code	Afmetingen (mm) (LxBxH)	Brutogewicht (kg)	EAN	st/doos
711000007800	LEDWaterproof-P4 L1208-38W-840	94051190	1222x70x80	1,26	6931783015056	1

### Technische specificaties

Levensduur (L70)	100.000 u
Levensduur (L80)	80.000 u
Aan-/Uit-cycli	100.000
Kleurconsistentie (SDCM)	4
Dimbaarheid	On-Off
Bundelhoek	120°
Afwerking	Grijs RAL 7035
CRI	≥ 80
Beschermingsgraad (IP)	IP66
Slagvastheid	IK08
Beschermingsklasse	II
Risicogroep (EN 62471)	RG0
Voorschakelapparaat inbegrepen	Ja
Gloeidraadtest	850°C
Vermogensfactor	≥ 0,9
Diameter van ingangsdraad	1mm <sup>2</sup> - 2.5mm <sup>2</sup>

### Elektrische aansluiting

Frequentie	50/60 Hz
Nom. spanning	220-240 V
DC ingangsspanning	Zie catalogusbijlage Aansluitwaarden

### Materiaal eigenschappen

Materiaal behuizing	Polycarbonaat
UV-bestendig	Ja
Materiaal optiek	Polycarbonaat
Bvestigingsclips	Roestvaststaal (RVS)

### Toepassingscondities

Bedrijfstemperatuur	-30-+45°C
Gebruikstemperatuur	+25°C
Opslagtemperatuur	-30-+50°C



## Maatschets (mm)

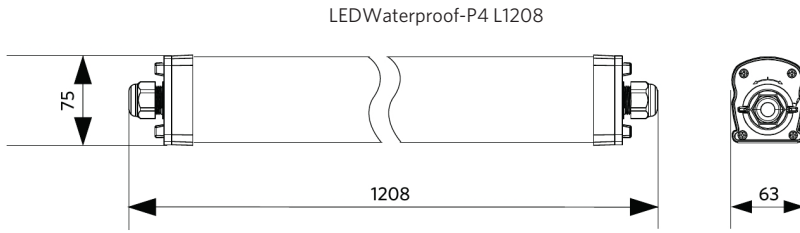

## Installatiemogelijkheden

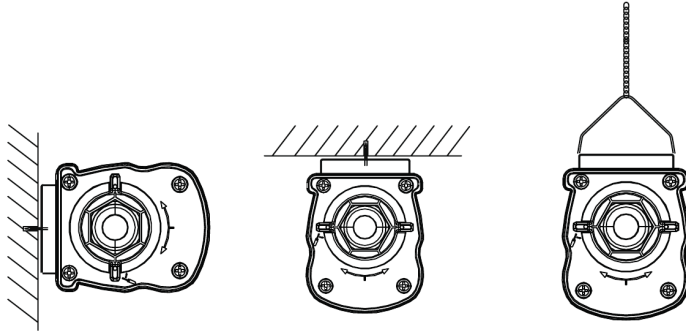

## Fotometrische gegevens

