

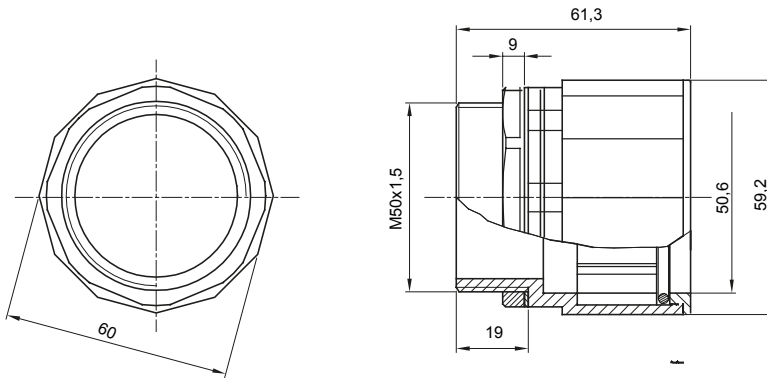

Routing components for rigid protective conduits with IP40 and IP67 protection degree.

Colour	Grey RAL 7035	IP degree	IP67
ISO pitch	M 50x1.5	For holes Ø (mm)	50
Conduits Ø (mm)	50	Type of material	Halogen-free in compliance with EN 60754-2
Electrocod	21221		

DIMENSIONAL



TECHNICAL SYMBOLOGY

IP

HF
HALOGEN FREE

IP67

STANDARDS/APPROVALS

