

Product Data Sheet

GW44647

46 Range

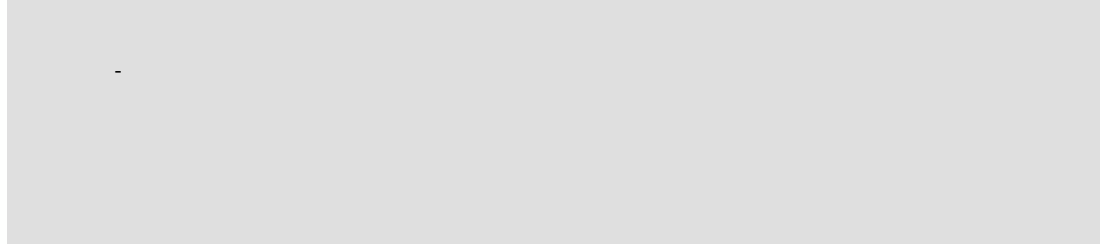
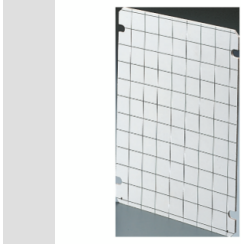

For boards LxH (mm)	236x316	For boards	44 CEP
Type of material	Insulation	Electrocod	1320

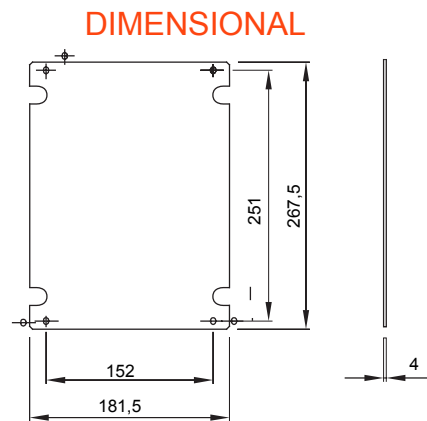

STANDARDS/APPROVALS

