

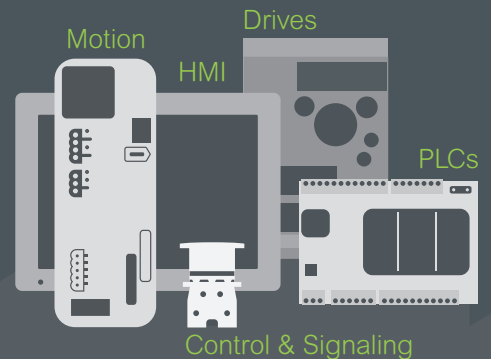

Introducing the **Easy Series**

Essential automation & control products

When just enough is just right!



Easy Altivar 310

Variable speed drives

For applications from 0.37 to 22 kW / 0.5 to 30 HP

General contents

Easy Altivar 310 variable speed drives

■ Variable speed drives	page 2
□ Presentation	page 2
□ Applications	page 2
□ Functions	page 2
□ An optimized offer	page 3
□ References	page 5
■ Configuration tools	page 6
□ Simple Loader and Multi-Loader	page 6
□ Remote display terminals	page 6
■ Options	page 7
□ Line chokes, motor chokes	page 7
□ Braking resistors	page 9
□ Modbus serial link	page 9
■ Motor starters	page 10
■ Product reference index	page 12

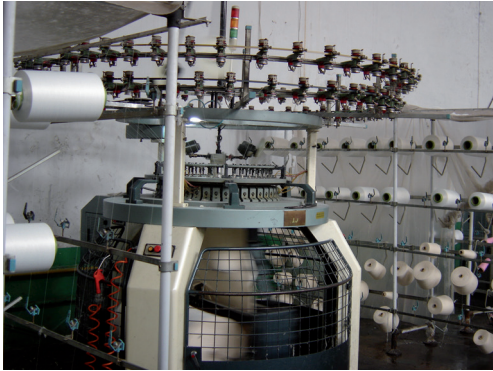

Textile machine

Presentation

The Easy™ Altivar 310 drive is a frequency inverter for three-phase 380...460 V asynchronous motors rated from 0.37 kW/0.5 HP to 22 kW/30 HP.

The compact size of this drive, its robust design, its ease of installation, based on the principle of Plug & Play, its integrated functions and macro configuration make it particularly suitable for applications involving industrial machines and certain consumer machines.

By taking account of the constraints governing installation and use at the product design stage, we have been able to offer a reliable, cost-effective solution to manufacturers of compact machines (OEMs).

The Easy Altivar 310 has been developed with no compromise on quality : the components are designed to last 10 years.

Applications

The Easy Altivar 310 drive incorporates functions that are suitable for the most common applications, including:

- Textile machine
- Machine tools
- Wood making machine
- Material handling
- Packaging and printing machines
- Ceramic machine

Functions

In addition to the functions usually available on this type of drive, the Easy Altivar 310 drive also features the following:

Motor control functions (1)

- Motor control profiles: standard, performance and pump/fan
- Cooling fan thermal control
- Switching frequency management
- Boost torque
- Motor noise reduction
- Current limitation
- Auto DC injection

Application functions (1)

- Frequency skip
- Preset speeds
- PID regulator
- S ramp, U ramp, ramp switching
- Jog operation
- +/- speed around reference
- Freewheel stop, fast stop
- Automatic catching a spinning load with speed detection and automatic restart

Control functions (1)

- Channel configuration - separate mode or not
- Reference channel selection
- Reverse inhibition
- Force local control
- Store customer parameter settings

Protection and maintenance functions (1)

- Protection of the installation by means of underload and overload detection
- Maintenance functions:
 - HMI password
 - Configuring the logic and analog I/O
 - Configuring how the parameters are displayed
 - Viewing the state of the logic inputs on the drive display
 - Key parameters display (drive power on / Fan time / Process elapsed time)
 - The last 4 fault display, error log, etc.

(1) For the implementation of functions, please consult the user manual on our local website.



Packaging machine



Printing machine



Easy Altivar 310 range

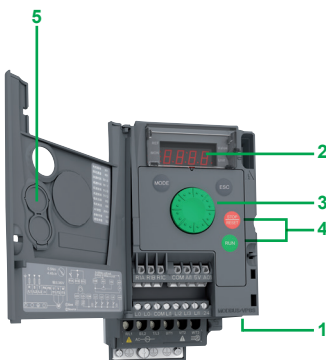

ATV310H037N4E with door on front panel open



Remote terminal with cover closed



Remote terminal with cover open: RUN, FWD/REV and STOP buttons accessible



Multi-Loader configuration tool

An optimized offer

Environment

The entire range conforms to international standards IEC/EN 61800-5-1 and IEC/EN 61800-3 and has been developed to meet the requirements of directives regarding the protection of the environment (RoHS, WEEE). Owing to its innovated air flow design and to its thicker coating which avoids polluting PCB, the range can be used in the harshest environments. It can withstand a 55 °C/131 °F ambient air temperature around the device without derating (1). Its degree of protection is IP 20 (IP40 on top of the product).

Adaptability and performances

The Easy Altivar 310 has been designed with an increased adaptability to different motors and various tough loads.

One of its main quality is its torque capacity for starting and braking:

- Braking capacity:
 - over 80 % of the rated motor torque without braking resistor
 - 150 % of the rated motor torque with braking resistor (see page 8)
- Torque capacity
 - starting torque 150 % at 3 Hz
 - over torque : 170 to 200 %, depending on model (2).

Easy to integrate in system

The Easy Altivar 310 drive integrates as standard the Modbus communication protocol, which can be accessed via the RJ45 connector located on the underside of the drive 1 with a 2-wire RS 485 physical interface. To communicate on the network, the Easy Altivar 310 speed drive uses the Modbus RTU transmission mode. For more information on the complementary characteristics of the Modbus port (transmission speed, address, messaging...), please consult our local website. Logic input can be configured as source or sink by software, compatible with many PLCs.

Easy to install

The Easy Altivar 310 drives can easily and quickly be installed as:

- they are easy and quick to wire due to their Plug & Play concept
- they can be identified on the front panel.
- they can be mounted side by side to save cabinet space.
- power terminal and connection labels are easily identified and differentiated
- a connection guideline is shown inside the front door.

Easy to commission

Human-Machine Interface (integrated keypad)

The 4-digit display 2 can be used to display states and faults, access parameters and modify them via the navigation button 3.

The RUN and STOP buttons 4 can be made accessible on the front panel by removing the blanking plate 5 from the door; they must be configured in order to be active.

Remote display terminal

The Easy Altivar 310 drive can be connected to a remote display terminal, available as an option. This terminal can be mounted on an enclosure door with IP 54 or IP 65 degree of protection. The maximum operating temperature is 50 °C/122 °F. It provides access to the same functions as the Human-Machine interface.

Simple Loader and Multi-Loader configuration tools

The Simple Loader tool enables one powered-up drive's configuration to be duplicated on another powered-up drive. Operation is very simple.

The Multi-Loader tool enables configurations from a PC or drive to be copied and duplicated on another drive; the drives do not need to be powered up. The configuration can be loaded onto the drive without taking it out of its packaging.

Easy to maintain

A warning is sent by the drive to the user when it is necessary to clean heat sink or replace cooling fan. This fan, which is the only wearing part, can be changed without the need for any tool.

The security of the system is ensured by an access code allowing authorized people to configure applications and settings in Configuration mode. Simple users are only allowed to use the Monitoring mode (parameters display).

(1) Detail temperature conditions and derating curves, please refer to User Manual.

(2) For more information, please refer to our local website.

Main characteristics

Analog input AI1

1 software-configurable voltage or current analog input:

- Voltage analog input: 0...5 V $\overline{=}$ (internal power supply only) or 0...10 V $\overline{=}$, impedance 30 k Ω

- Analog current input: X-Y mA by programming X and Y from 0–20 mA, Impedance 250 Ω

Sampling time: < 20 ms

Resolution: 10 bits

Accuracy: $\pm 1\%$ at 25 °C/77 °F

Linearity: $\pm 0.3\%$ of the maximum scale value

Factory setting: Input configured as voltage type

Analog output AO1

1 software-configurable voltage or current analog output:

- Analog voltage output: 0...10 V $\overline{=}$, minimum load impedance 470 Ω

- Analog current output: 0–20 mA, maximum load impedance 800 Ω

Sampling time: < 10 ms

Resolution: 8 bits

Accuracy: $\pm 1\%$ at 25 °C/77 °F

Relay outputs R1A, R1B, R1C

1 protected relay output, 1 N/O contact and 1 N/C contact with common point

Response time: 30 ms maximum

Minimum switching capacity: 5 mA for 24 V $\overline{=}$

Maximum switching capacity:

- On resistive load ($\cos \varphi = 1$ and L/R = 0 ms): 3 A at 250 V \sim or 4 A at 30 V $\overline{=}$

- On inductive load ($\cos \varphi = 0.4$ and L/R = 7 ms): 2 A at 250 V \sim or 30 V $\overline{=}$

Logic inputs LI1...LI4

4 programmable logic inputs, compatible with PLC level 1, standard IEC/EN 61131-2 24 V $\overline{=}$ internal power supply or 24 V $\overline{=}$ external power supply (min. 18 V, max. 30 V)

Sampling time: < 20 ms

Sampling time tolerance: ± 1 ms

Factory-set with 2-wire control in "transition" mode for machine safety reasons:

- LI1: forward

- LI2...LI4: not assigned

Multiple assignment makes it possible to configure several functions on one input (for example: LI1 assigned to forward and preset speed 2, LI3 assigned to reverse and preset speed 3)

Impedance 3.5 k Ω

Logic outputs LO1

One 24 V $\overline{=}$ logic output assignable as positive logic (Source) or negative logic (Sink) open collector type, compatible with level 1 PLC, standard IEC/EN 61131-2

Maximum voltage: 30 V

Linearity: $\pm 1\%$

Maximum current: 100mA (1)

Impedance: 1 k Ω

Update time: < 20 ms

Note:

(1) LO logic output maximum current could be 100mA when external power supply or internal +24V supply alone to LO. If the internal +24V supply logic inputs also, the maximum current will be 80mA.

Variable speed drives

Easy Altivar 310

Drives



ATV310H037N4E



ATV310HU15N4E



ATV310HU30N4E



ATV310HU75N4E



ATV310HD15N4E



ATV310HD22N4E

Drives										
Three-phase supply voltage: 380...460 V 50/60 Hz										
Motor	Line supply				Easy Altivar 310					
Power indicated on rating plate (1)	Max. line current (2)		Apparent power	Maximum continuous output current (In) (1)	Maximum transient current for 60 s	Dissipated power at maximum output current (In) (1)	Reference (6)	Weight (3)		
HD: Heavy duty (4) ND: Normal duty (5)	380 V		460 V	380 V		W			kg/lb	
	kW	HP	A	A	kVA				A	A
HD	0.37	0.5	2.1	1.8	1.4	1.5	2.3	22.7	ATV310H037N4●	0.800/1.760
HD	0.75	1	3.5	3.1	2.5	2.3	3.5	34.1	ATV310H075N4●	0.800/1.760
HD	1.5	2	6.5	5.4	4.3	4.1	6.2	60.4	ATV310HU15N4●	1.100/2.430
HD	2.2	3	8.8	7.2	5.7	5.5	8.3	75.5	ATV310HU22N4●	1.100/2.430
HD	3	4	11.1	9.2	7.3	7.1	10.7	90.8	ATV310HU30N4●	1.800/3.970
ND	4	5	14.2	11.6	9.3	8.9	9.8	120.4		
HD	4	5	13.7	11.4	9.1	9.5	14.3	115.1	ATV310HU40N4●	1.800/3.970
ND	5.5	7.5	18.0	14.9	15.1	12.1	13.3	158.3		
HD	5.5	7.5	21.3	14.3	11.4	12.6	18.9	162.4	ATV310HU55N4●	1.800/3.970
ND	7.5	10	23.0	19.0	15.1	16.0	17.6	201.9		
HD	7.5	10	26.6	22.4	17.8	17	25.5	241.2	ATV310HU75N4●	3.700/8.160
ND	11	15	29.5	24.8	19.4	22.8	25.1	317.8		
HD	11	15	36.1	30.4	24.2	24	36	337.1	ATV310HD11N4●	3.700/8.160
ND	15	20	38.6	32.5	25.4	30	33	407.0		
HD	15	20	46.5	38.5	30.7	33	49.5	416.0	ATV310HD15N4●	6.300/13.900
ND	18.5	25	46.6	38.8	31.2	36	39.6	451.7		
HD	18.5	25	55.3	45.8	36.5	39	58.5	515.9	ATV310HD18N4●	6.300/13.900
ND	22	30	54.1	45.1	35.7	43	47.3	539.4		
HD	22	30	64.2	53.2	46.2	46	69	568.8	ATV310HD22N4●	8.500/18.700
ND	30	40	71.2	59.2	47	60	66	735.6		
HD	15	20	46.5	38.5	30.7	33	49.5	424.4	ATV310HD15N4●F	6.700/14.800
ND	18.5	25	46.6	38.8	31.2	36	39.6	460.2		
HD	18.5	25	55.3	45.8	36.5	39	58.5	527.8	ATV310HD18N4●F	6.700/14.800
ND	22	30	54.1	45.1	35.7	43	47.3	550.9		
HD	22	30	64.2	53.2	46.2	46	69	593.5	ATV310HD22N4●F	9.700/21.400
ND	30	40	71.2	59.2	47	60	66	765.9		

Dimensions (overall)		
Drives with heatsinks	W x H x D	
	mm	in.
ATV310H037N4●	72 x 143 x 130	2.83 x 5.63 x 5.12
ATV310H075N4●	72 x 143 x 140	2.83 x 5.63 x 5.51
ATV310HU15N4●, ATV310HU22N4●	105 x 143 x 151	4.13 x 5.63 x 5.94
ATV310HU30N4●, ATV310HU40N4●, ATV310HU55N4●	140 x 184 x 151	5.51 x 7.24 x 5.94
ATV310HU75N4●, ATV310HD11N4●	150 x 232 x 171	5.91 x 9.13 x 6.73
ATV310HD15N4●, ATV310HD18N4●, ATV310HD15N4●F, ATV310HD18N4●F	180 x 330 x 191	7.09 x 12.99 x 7.52
ATV310HD22N4●, ATV310HD22N4●F	180 x 390 x 212	7.09 x 15.35 x 8.35

(1) These values are given for a nominal switching frequency of 4 kHz, for use in continuous operation. If operation above 4 kHz needs to be continuous, the nominal drive current should be derated by 10% for 8 kHz and 20% for 12 kHz.

The switching frequency can be set between 2 and 12 kHz for all ratings. Above 4 kHz, the drive will reduce the switching frequency automatically in the event of an excessive temperature rise. See the derating curves in the User Manual, available on our local website.

(2) Typical value for the indicated motor power and for the maximum prospective line Isc.

- ≤ 4kW, network short circuit current Isc ≤ 5kA
- > 4kW, network short circuit current Isc : ≤ 22kA for Heavy duty, ≤ 5kA for Normal duty

(3) Weight of product without packaging.

(4) Values given for applications requiring significant overload (up to 150% for 60 s).

(5) Values given for applications requiring slight overload (up to 110% for 60 s).

(6) Easy Altivar ATV310●●●N4●F drives with integrated EMC filter category C3 with 25 m/82 ft shielded motor cable.

Configuration tools

Description	For drives	Reference	Weight kg/lb
Simple Loader, Multi-Loader configuration tools and associated cable			
Simple Loader tool For duplicating one drive configuration on another drive. The drives must be powered-up. The tool is supplied with a cordset equipped with 2 RJ45 connectors.	ATV310H●●●N4●	VW3A8120	—
Multi-Loader tool 1 For copying a configuration on a PC or drive and duplicating it on another drive. The drives do not need to be powered-up. Supplied with the tool: <ul style="list-style-type: none"> ■ 1 cordset equipped with 2 RJ45 connectors ■ 1 cordset equipped with a USB type A connector and a USB Mini-B type connector ■ 1 x 2 GB SD memory card ■ 1 female/female RJ45 adaptor ■ 4 AA/LR6 1.5 V batteries 	ATV310H●●●N4●	VW3A8121	—
Cordset for Multi-Loader tool 2 For connecting the Multi-Loader tool to the Easy Altivar 310 drive in its packaging. Equipped with a non-locking RJ45 connector with special mechanical catch on the drive end and an RJ45 connector on the Multi-Loader end.	ATV310H●●●N4● in its packaging	VW3A8126	—

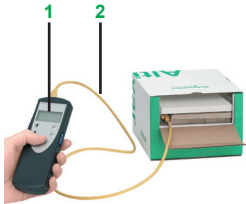

Configuring the drive in its packaging with the Multi-Loader tool VW3A8121+ cordset VW3A8126

Remote display terminals and associated cordsets

Description	Degree of protection	For drives	Reference	Weight kg/lb
Remote display terminals For fixing the Human-Machine interface on an enclosure door with IP 54 or IP 65 degree of protection. A remote-fixing cordset VW3A1104R●● is also required.	IP 54	ATV310H●●●N4●	VW3A1006	0.250/0.550
	IP 65	ATV310H●●●N4●	VW3A1007	0.275/0.610
Remote-fixing cordsets equipped with 2 RJ45 connectors. For connecting the VW3A1006 or VW3A1007 remote display terminal to the Easy Altivar 310 drive.	Length: 1 m/3.28 ft	ATV310H●●●N4●	VW3A1104R10	0.050/0.110
	Length: 3 m/9.84 ft	ATV310H●●●N4●	VW3A1104R30	0.150/0.330



VW3A1006 with cover open: RUN, FWD/REV and STOP buttons accessible

Dimensions (overall)

Remote display terminal	W x H x D	
	mm	in.
VW3A1006	50 x 70 x 22.7	1.97 x 2.76 x 0.89
VW3A1007	66 x 106 x 26.7	2.6 x 4.17 x 1.05

Presentation

Line chokes

A line choke can be used to provide improved protection against overvoltages on the line supply and to reduce harmonic distortion of the current produced by the drive. They are recommended for ATV310...N4E drives. The recommended chokes limit the line current. They have been developed in line with standard EN 50178 (VDE 0160 level 1 high energy overvoltages on the line supply). The choke values are defined for a voltage drop between phases of between 3% and 5% of the nominal supply voltage. Values higher than this will cause loss of torque. These chokes should be installed upstream of the drive.

The use of line chokes is recommended in particular under the following circumstances:

- Close connection of several drives in parallel
- Line supply with significant disturbance from other equipment (interference, overvoltages)
- Line supply with voltage imbalance between phases above 1.8% of the nominal voltage
- Drive supplied by a line with very low impedance (in the vicinity of a power transformer 10 times more powerful than the drive rating)
- Installation of a large number of frequency inverters on the same line
- Reducing overloads on the cosφ correction capacitors, if the installation includes a power factor correction unit.

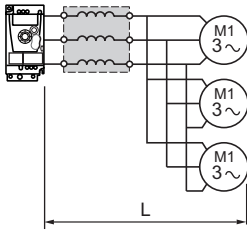

VW3A455●
Motor choke

Presentation

Motor chokes

Motor chokes are required:

- When connecting more than 2 motors in parallel
- When the motor cable length (L), including tap-offs, is:
 - 25 m/82.02 ft maximum for a shielded motor cable (1),
 - 50 m/164.04 ft maximum for an unshielded motor cable (1).

Motor chokes can be inserted between the Altivar ATV310 drive and the motor to:

- Limit the dv/dt at the motor terminals (500 to 1500 V/μs), for cables longer than 50 m/164.04 ft
- Filter interference caused by the opening of a contactor placed between the filter and the motor
- Reduce the motor ground leakage current
- Smooth the motor current wave form to reduce motor noise

References

Line chokes

For drives

	Duty	Line current without choke		Line current with choke		Choke Reference	Weight
		380 V		460 V			
		A	A	A	A		
ATV310H037N4●	HD	2.1	1.8	1.1	1	VW3A4551	1.500/3.310
ATV310H075N4●	HD	3.5	3.1	1.9	1.7		
ATV310HU15N4●	HD	6.5	5.4	3.5	2.9	VW3A4552	3.700/8.160
ATV310HU22N4●	HD	8.8	7.2	5.1	4.4		
ATV310HU30N4●	HD	11.1	9.2	6.6	5.6	VW3A4552	3.700/8.160
	ND	14.2	11.6	8.5	7.1		
ATV310HU40N4●	HD	13.7	11.4	8.5	7.7	VW3A4553	4.100/9.040
	ND	18	14.9	11.6	9.9		
ATV310HU55N4●	HD	21.3	14.3	11.6	9.9	VW3A4553	4.100/9.040
	ND	23	19	15.3	12.8		
ATV310HU75N4●	HD	26.6	22.4	16.1	14.2	VW3A4554	6.150/13.230
	ND	29.5	24.8	22.2	18.8		
ATV310HD11N4●	HD	36.1	30.4	22	18.3	VW3A4554	6.150/13.230
	ND	38.6	32.5	29.9	25		
ATV310HD15N4●	HD	46.5	38.5	28.9	24.4	VW3A4554	6.000/13.228
	ND	46.6	38.8	29	29		
ATV310HD18N4●	HD	55.3	45.8	36.4	31.6	VW3A4555	11.000/24.251
	ND	54.1	45.1	41.8	35.3		
ATV310HD22N4●	HD	64.2	53.2	42.4	36.3	VW3A4555	11.000/24.251
	ND	71.2	59.2	57.2	48.3	VW3A4556	16.000/35.270
ATV310HD15N4●F	HD	46.5	38.5	28.9	24.4	VW3A4554	6.000/13.228
	ND	46.6	38.8	29	29		
ATV310HD18N4●F	HD	55.3	45.8	36.4	31.6	VW3A4555	11.000/24.251
	ND	54.1	45.1	41.8	35.3		
ATV310HD22N4●F	HD	64.2	53.2	42.4	36.3	VW3A4555	11.000/24.251
	ND	71.2	59.2	57.2	48.3	VW3A4556	16.000/35.270

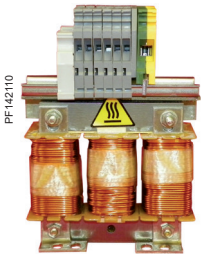

VW3A455●

Motor chokes (2)

Drive Reference	Operation mode Duty	Rated current A	Power loss A	Choke Reference A
ATV310H037N4●	HD	4	45	VW3A4551
ATV310H075N4●	HD	4	45	VW3A4551
ATV310HU15N4●	HD	10	65	VW3A4552
ATV310HU22N4●	HD	10	65	VW3A4552
ATV310HU30N4●	HD	10	65	VW3A4552
	ND	10	65	VW3A4552
ATV310HU40N4●	HD	10	65	VW3A4552
	ND	17	75	VW3A4553
ATV310HU55N4●	HD	17	75	VW3A4553
	ND	17	75	VW3A4553
ATV310HU75N4●	HD	31	90	VW3A4554
	ND	31	90	VW3A4554

(1) Motor cable length given for a switching frequency of 4 kHz.

(2) With motor chokes, all the ranges drive can be used for maximum 100 m/328.08 ft with shielded motor cables and 200 m/656.17 ft with unshielded motor cables.

Variable speed drives

Easy Altivar 310

Options: line chokes, motor chokes

Motor chokes (2)				
Drive Reference	Operation mode Duty	Rated current A	Power loss A	Choke Reference A
ATV310HD11N4●	HD	31	90	VW3A4554
	ND	31	90	VW3A4554
ATV310HD15N4●	HD	60	94	VW3A4555
	ND	60	94	VW3A4555
ATV310HD18N4●	HD	60	94	VW3A4555
	ND	60	94	VW3A4555
ATV310HD22N4●	HD	60	94	VW3A4555
	ND	107	260	VW3A4556
ATV310HD15N4●F	HD	60	94	VW3A4555
	ND	60	94	VW3A4555
ATV310HD18N4●F	HD	60	94	VW3A4555
	ND	60	94	VW3A4555
ATV310HD22N4●F	HD	60	94	VW3A4555
		107	260	VW3A4556

Dimensions (overall)		
Line chokes or motor chokes	W x H x D	
	mm	in.
VW3A4551	100 x 135 x 60	3.94 x 5.31 x 2.36
VW3A4552, VW3A4553	130 x 155 x 90	5.12 x 6.1 x 3.54
VW3A4554	155 x 170 x 135	6.1 x 6.69 x 5.31
VW3A4555	180 x 210 x 160	7.1 x 8.27 x 6.30
VW3A4556	270 x 210 x 180	10.63 x 8.27 x 7.09

(1) Motor cable length given for a switching frequency of 4 kHz.

(2) With motor chokes, all the ranges drive can be used for maximum 100 m/328.08 ft with shielded motor cables and 200 m/656.17 ft with unshielded motor cables.



VW3A7701

Braking resistors

For drives	Minimum Ohmic value Ω	Ohmic value at	Power available at	Reference	Weight kg/ lb
		20° C/68 °F Ω	50° C/122 °F (1) W		
Not protected resistor (IP00) (2)					
ATV310HU15N4●	80	100	28	VW3A7723	0.600/ 1.320
ATV310HU22N4●	60				
ATV310HU30N4●	36	100	35	VW3A7725	0.850/ 1.870
ATV310HU40N4●	36				
Protected resistor (IP20 or 23)					
ATV310HU15N4●	80	100	100	VW3A7730	1.500/ 3.306
ATV310HU22N4●	60				
ATV310HU30N4●	36				
ATV310HU40N4●	36				
ATV310HU55N4●	28	60	160	VW3A7731	2.000/ 4.409
ATV310HU75N4●	28				
ATV310HD11N4●	28	28	300	VW3A7732	3.000/ 6.613
ATV310HD15N4●	16	16	960	VW3A7733	4.000/ 8.818
ATV310HD18N4●	10	16	960		
ATV310HD22N4●	10	16	960		
ATV310HD15N4●F	16	16	960		
ATV310HD18N4●F	10	16	960		
ATV310HD22N4●F	10	16	960		

Dimensions (overall)

Braking resistors	W x H x D	
	mm	in.
VW3A7723	60 x 170 x 30	2.36 x 6.659 x 1.18
VW3A7725	62 x 212 x 36	2.44 x 8.35 x 1.42
VW3A7730	105 x 295 x 100	4.13 x 11.61 x 3.94
VW3A7731	105 x 345 x 100	4.13 x 13.58 x 3.94
VW3A7732	175 x 345 x 100	6.89 x 13.58 x 3.94
VW3A7733	190 x 570 x 180	7.48 x 22.44 x 7.09

Modbus serial link

Description	Item no.	Length m/ft	Unit reference	Weight kg/ lb	
Connection via splitter box and RJ45 connectors					
Modbus splitter box 10 RJ45 connectors and 1 screw terminal		–	LU9GC3	0.500/ 1.100	
Cordsets for Modbus serial link equipped with 2 RJ45 connectors	2	0.3/0.98	VW3A8306R03	0.025/ 0.060	
		1/3.28	VW3A8306R10	0.060/ 0.060	
		3/9.84	VW3A8306R30	0.130/ 0.290	
Modbus T-junction boxes (with integrated cable)	3	0.3/0.98	VW3A8306TF03	0.190/ 0.420	
		1/3.28	VW3A8306TF10	0.210/ 0.460	
Line terminators (5) (6) For RJ45 connector	R = 120 Ω C = 1 nf	4	–	VW3A8306RC	0.010/ 0.020
	R = 150 Ω	4	–	VW3A8306R	0.010/ 0.020

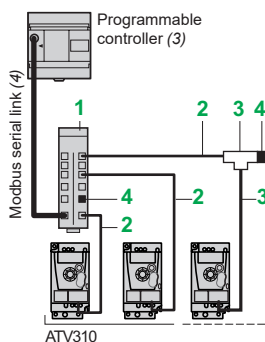

Example of Modbus diagram with connection via splitter box and RJ45 connectors

(1) Load factor for resistors: the value of the average power that can be dissipated at 50 °C from the resistor into the casing is determined for a load factor during braking that corresponds to the majority of normal applications.

(2) For not protected resistors, add a thermal overload device.

(3) Please refer to the programmable controller catalogue on our local website.

(4) Cable depends on the type of controller or PLC.

(5) Order in multiples of 2.

(6) Depends on the bus architecture.

Applications

The proposed combinations can:

- Protect people and equipment (when a short-circuit occurs)
- Maintain protection upstream of the drive in the event of a short-circuit on the power stage

Two types of combination are possible:

- Drive + circuit-breaker: Minimum combination
- Drive + circuit-breaker + contactor: Minimum combination with contactor when a control circuit is needed

Motor starters

Three-phase supply voltage: 380...460 V 50/60 Hz

Standard power ratings of threephase 4-pole 50/60 Hz motors (2)	Variable speed drive	Combination with control circuit			
		Minimum combination (circuit-breaker only)	EasyPact TVS circuit breaker (3)	Operating range or rating	EasyPact TVS contactor (1)
kW	HP		A		
M1	A1	Q1		KM1	
0.37	0.5	ATV310H037N4●	GZ1LE07	2.5	LC1E06●●●●
0.75	1	ATV310H075N4●	GZ1LE08	4	LC1E06●●●●
1.5	2	ATV310HU15N4●	GZ1LE14	10	LC1E09●●●●
2.2	3	ATV310HU22N4●	GZ1LE14	10	LC1E09●●●●
3	4	ATV310HU30N4●	GZ1LE16	14	LC1E18●●●●
4	5.4	ATV310HU40N4●	GZ1LE20	18	LC1E18●●●●
5.5	7.4	ATV310HU55N4●	GZ3LE25	25	LC1E25●●●●
7.5	10	ATV310HU75N4●	GZ3LE32	32	LC1E32●●●●
11	15	ATV310HD11N4●	GZ3LE40	40	LC1E40●●
15	20	ATV310HD15N4●	GZ3LE50	50	LC1E50●●
18.5	25	ATV310HD18N4●	GZ3LE65	65	LC1E65●●
22	30	ATV310HD22N4●	GZ3LE73	73	LC1E80●●

(1) For a complete list of references for EasyPact TVS contactors, please visit our local website.
 (2) Motor power indicated for combination with an ATV310H●●●N4E drive with the same rating.
 (3) EasyPact TVS motor protection circuit breaker:
 - GZ1LE: Magnetic motor circuit-breakers with pushbutton control
 - GZ3LE: Magnetic motor circuit-breakers with pushbutton control (not released yet, please contact Schneider for details).

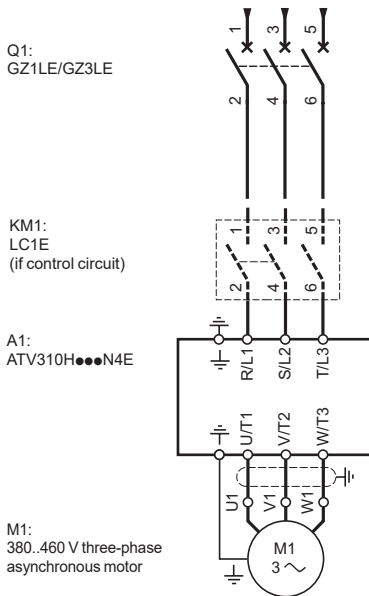

Motor starter with three-phase power supply

A	
ATV310H037N4●	5
ATV310H075N4●	5
ATV310HD11N4●	5
ATV310HD15N4●	5
ATV310HD15N4●F	5
ATV310HD18N4●	5
ATV310HD18N4●F	5
ATV310HD22N4●	5
ATV310HD22N4●F	5
ATV310HU15N4●	5
ATV310HU22N4●	5
ATV310HU30N4●	5
ATV310HU40N4●	5
ATV310HU55N4●	5
ATV310HU75N4●	5
L	
LU9GC3	9
V	
VW3A1006	6
VW3A1007	6
VW3A1104R10	6
VW3A1104R30	6
VW3A4551	7
VW3A4552	7
VW3A4553	7
VW3A4554	7
VW3A4555	7
VW3A4556	7
VW3A7723	9
VW3A7725	9
VW3A7730	9
VW3A7731	9
VW3A7732	9
VW3A7733	9
VW3A8120	6
VW3A8121	6
VW3A8126	6
VW3A8306R	9
VW3A8306R03	9
VW3A8306R10	9
VW3A8306R30	9
VW3A8306RC	9
VW3A8306TF03	9
VW3A8306TF10	9

Life Is On



Learn more about our products at
www.schneider-electric.com

The information provided in this documentation contains general descriptions and/or technical characteristics of the performance of the products contained herein. This documentation is not intended as a substitute for and is not to be used for determining suitability or reliability of these products for specific user applications. It is the duty of any such user or integrator to perform the appropriate and complete risk analysis, evaluation and testing of the products with respect to the relevant specific application or use thereof. Neither Schneider Electric nor any of its affiliates or subsidiaries shall be responsible or liable for misuse of the information contained herein.

Design: Schneider Electric
Photos: Schneider Electric

Schneider Electric Industries SAS

Head Office
35, rue Joseph Monier - CS 30323
F-92500 Rueil-Malmaison Cedex
France

DIA2ED2140701EN
February 2022 - V4.0