

Product Data Sheet

GW95488

90 RCD Range



Description	HIGH PERFORMANCE RESIDUAL CURRENT DEVICE
Code	BDHP
No. of poles	4P
No. modules	6
Rated current	125 A
Rated residual operating current	300 mA
Type	A[S]
Rated voltage (IEC/EN 61009-1 app. G, IEC/EN 61009-2-1 app. G)	400 V

Standard	IEC/EN 61009-1 app. G, IEC/EN 61009-2-1 app. G	Rated frequency (Hz)	50/60 Hz
Insulation voltage	500 V	Rated impulse withstand voltage	4 kV
Overvoltage category	III	Level of immunity (8/20 μs)	3000 A
Section rigid cable	Max 70 mm ²	Section flexible cable	Max 50 mm ²
Operating temperature	-25 +40 °C	Stocking temperature	-40 +70 °C
Rated tightening torque	3.5 / 3 (terminals)	Assembly position	Any

DIMENSIONAL

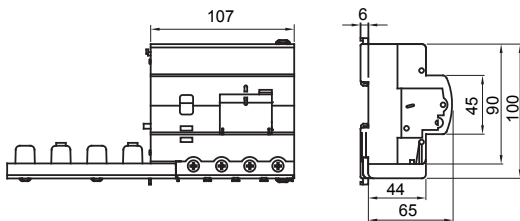

WIRING DIAGRAM

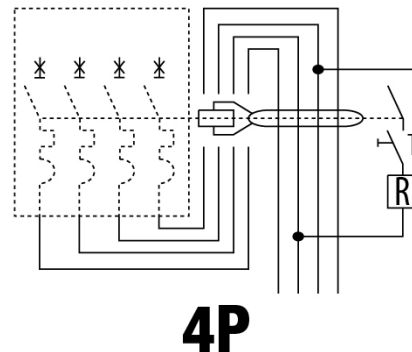

STANDARDS/APPROVALS

