

WDE005000  
WDE005030

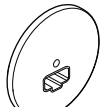

WDE005001



WDE005022  
WDE005023  
WDE005035

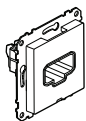

WDE005010  
WDE005011  
WDE005012



WDE005018  
WDE005019

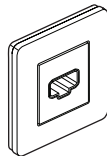

WDE005013  
WDE005032

**⚠ DANGER  
HAZARD OF ELECTRIC SHOCK,  
EXPLOSION, OR ARC FLASH**

Safe electrical installation must be carried out only by skilled professionals. Skilled professionals must prove profound knowledge in the following areas:

- Connecting to installation networks
- Connecting several electrical devices
- Laying electric cables
- Safety standards, local wiring rules and regulations

Failure to follow these instructions will result in death or serious injury.

**⚠ FARA  
RISK FÖR ELEKTRISK SHOCK,  
EXPLOSION OCH BÅGBLIXT**

Av säkerhetsskäl skall installation endast utföras av utbildad personal. Utbildad personal skall uppvisa djupt kunskande inom följande områden:

- Anslutning till installationsnätverk
- Anslutning till flera elektriska apparater
- Dragning av elkablar
- Säkerhetsstandarder samt lokala kabeldragnings föreskrifter och -regler

Om dessa instruktioner inte åtföljs kan det resultera i allvarliga skador eller dödsfall.

**⚠ FARE  
FARE FOR ELEKTRISK STÖT,  
EKSPLOSION ELLER OVERLEDNING**

Sikre elektroinstallasjoner må utelukkende utføres av autoriserte installatører. De autoriserte installatørene må ha inngående kunnskap innen følgende områder:

- Tilkobling til installasjonsnettverk
- Tilkobling av flere elektriske enheter
- Legging av elektriske kabler
- Sikkerhetsstandarder, lokale kabeltrek kregler og reguleringer

Hvis disse instruksene ikke overholdes vil dette resultere i dødsfall eller alvorlige skader.

**⚠ VAARA  
SÄHKÖISKUN, RÄJÄHDYKSEN TAI  
VALOKAAREN VAARA**

Turvallisen sähköasennuksen saavat suorittaa vain pätevät ammattilaiset. Pätevillä ammattilaisilla täytyy olla perusteelliset tiedot seuraavilla alueilla:

- asennusverkkoihin yhdistäminen
- useiden sähkölaitteiden yhdistäminen
- sähkökaapeleiden asentaminen
- turvallisuusstandardit, paikalliset johdotussäännöt ja määräykset

Näiden ohjeiden noudattamatta jättämisen seurauksena on kuolema tai vakavia vammoja.

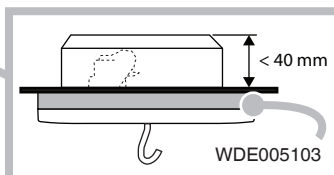
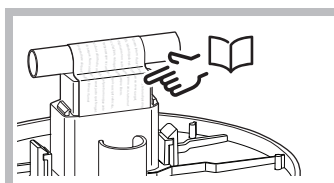
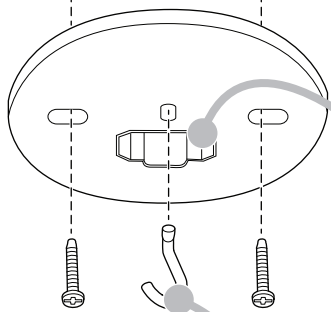
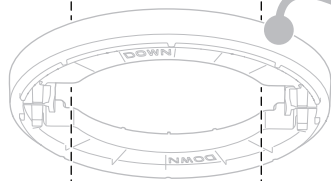
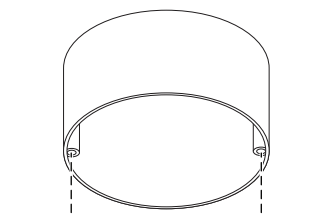

Must be ordered separately.  
Måste beställas separat.  
Må bestilles separat.  
Täytyy tilata erikseen.

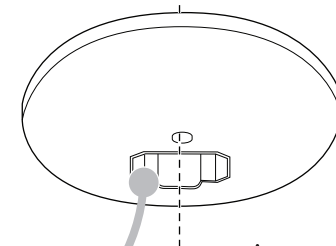
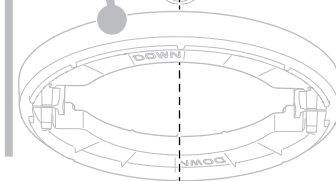
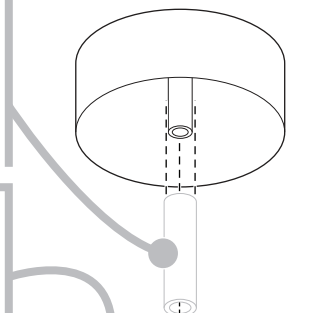
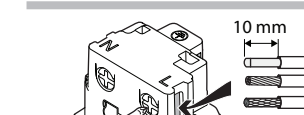
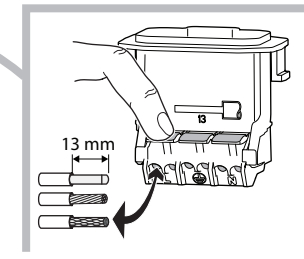

Must be ordered separately.  
Måste beställas separat.  
Må bestilles separat.  
Täytyy tilata erikseen.

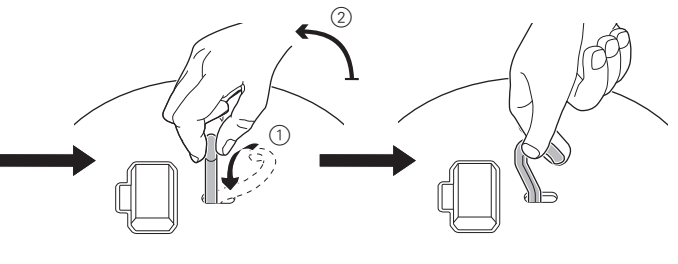
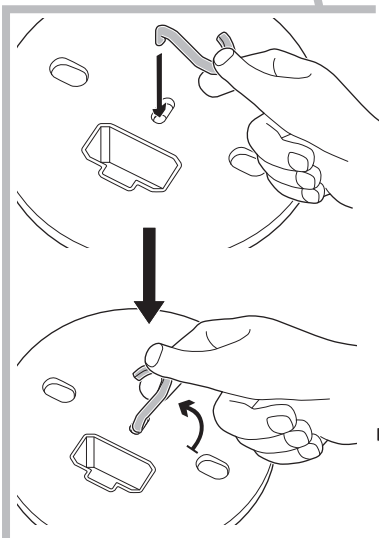

**Only applicable in Norway:**  
The absence of connected earth must be notified properly.  
Attach enclosed symbol sticker as shown.

**Gäller endast Norge:**  
Om jordanslutning saknas måste detta meddelas ordentligt.  
Sätt dit den medföljande symboletiketten enligt bilden.

**Bare til bruk i Norge:**  
Fraværet av jordforbindelse må varsles på riktig vis.  
Fest vedlagt symbolmerke som vist.

**Käytettävissä vain Norjassa:**  
Yhdistetyn maadoituksen poissaolo täytyy merkitä oikein.  
Kiinnitä oheinen symbolitarra kuvan mukaan.



Nominal current: Märkström: Merkestrøm: Nimellisvirta:		6 A
Nominal voltage: Märkspänning: Merkespenning: Nimellisjännite:		AC 250 V

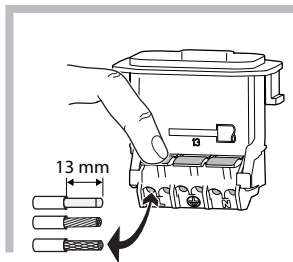
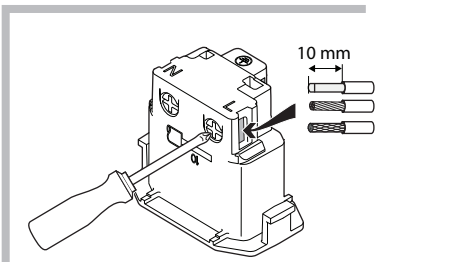
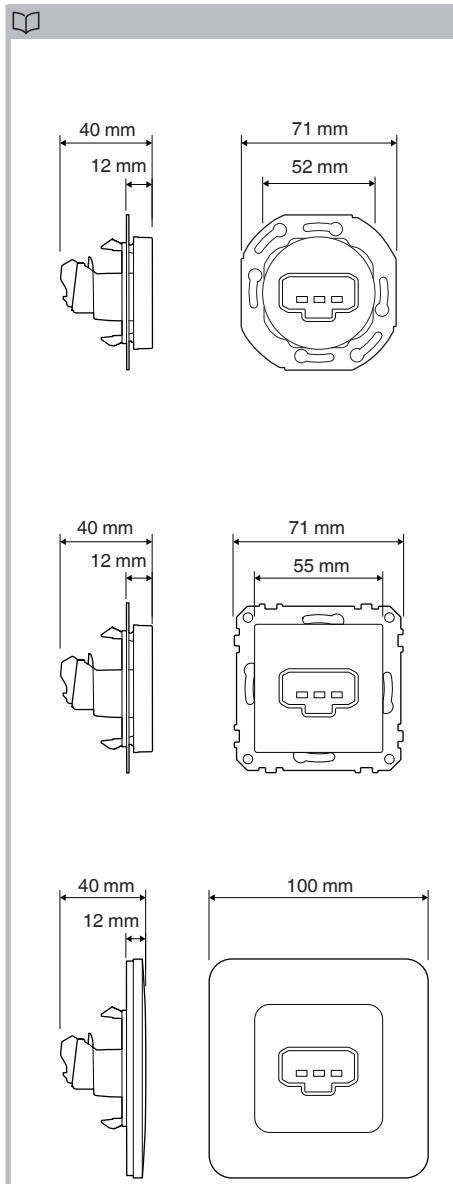
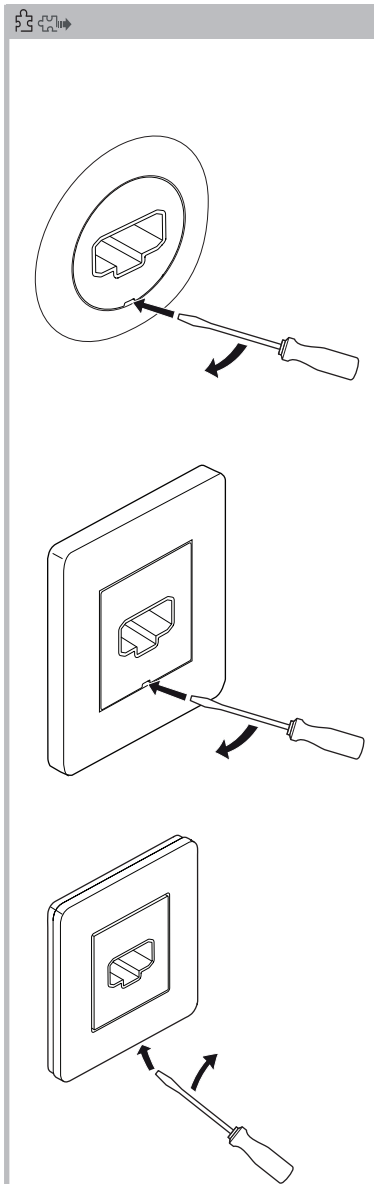
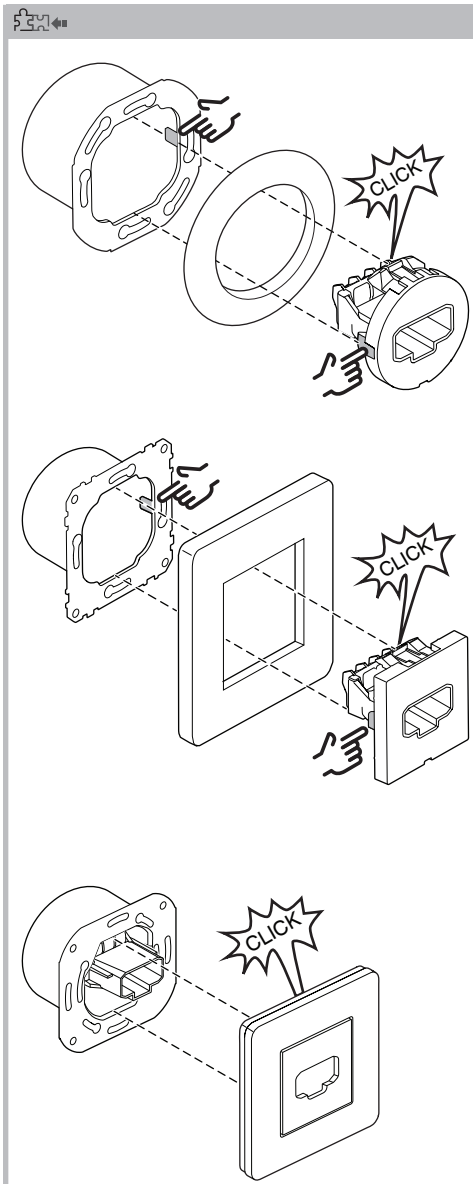

Nominal current: Märkström: Merkestrøm: Nimellisvirta:	6 A
Nominal voltage: Märkspänning: Merkespenning: Nimellisjännite:	AC 250 V

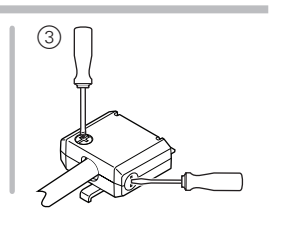
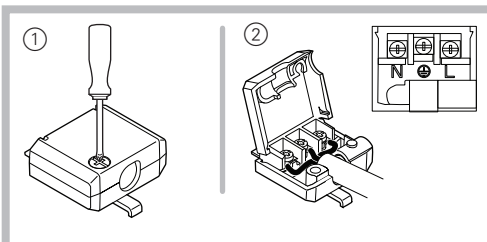

**Only applicable in Norway:**  
Gäller endast Norge:  
Bare til bruk i Norge:  
Käytettävissä vain Norjassa:

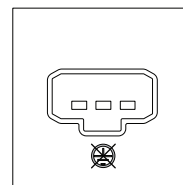

 Dispose of the device separately from household waste at an official collection point. Professional recycling protects people and the environment against potential negative effects.

Återvinn utrustningen separat från hushållsavfallet vid ett officiellt uppsamlingsställe. Professionell återvinning skyddar människor och miljö mot de negativa effekter som kan uppstå.

Ikke kast apparatet i det vanlige husholdningsavfallet, men lever det på et offentlig innsamlingssted. Profesjonell gjenvinning beskytter mennesker og miljø mot mulige negative effekter.

Toimita laite kotitalousjätteistä erotettuna viralliseen jätteiden vastaanottopisteeseen. Ammattimainen kierrätys suojelee ihmisiä ja ympäristöä mahdollisesti haitallisilta vaikutuksilta.

**Schneider Electric Industries SAS**

If you have technical questions, please contact the Customer Care Centre in your country.  
schneider-electric.com/contact