

# Product Data Sheet

## DX47503

RK Range



Routing components for rigid protective conduits with IP40 and IP67 protection degree.

Colour	Grey RAL 7035	Characteristics	Halogen free
For cables Ø (mm)	3-6	Electrocod	21221

### DIMENSIONAL

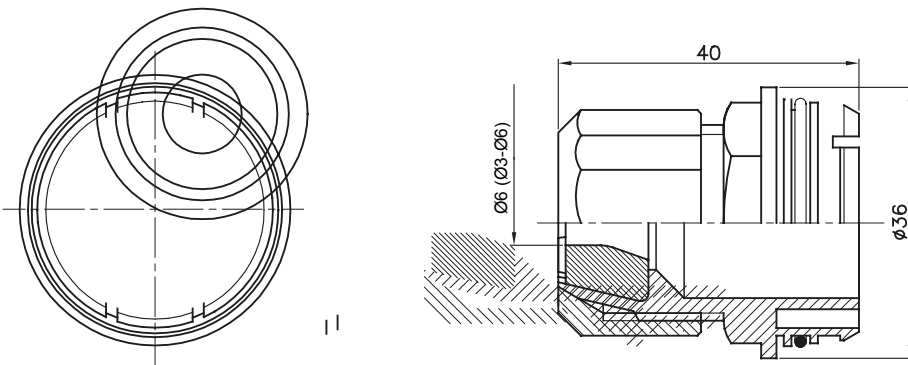

### TECHNICAL SYMBOLOGY



### STANDARDS/APPROVALS

