

IP65 Moisture-proof diffuser luminaire

IP65 LED Moisture proof luminaire with opal diffuser for indoor and covered outdoor installation. Innovative design with extra long bracket sliders (400 mm) for ease of installation making it an ideal refurbishment luminaire. Made of high quality polycarbonate (UV stabilised), the design is streamlined and clip free, whilst still providing easy but secure access to the driver. Total luminous flux: 6300 lm, Luminaire input power: 51 W, Luminaire efficacy: 124 lm/W, CCT: 4000K. Lifetime: 50.000hrs @L80. Colour Rendering: CRI > 80, Chromaticity tolerance (initial MacAdam): 4, Impact strength: IK08. Including 3 pole quick connector. Available accessories: Suspension kit. Lumen package adjustable on site by 3 steps FLEX1: 6300 lm (51W), FLEX2: 5200 lm (41W), FLEX3: 4200 lm (33W). Detailed power setting information available on www.THORNeco.com. Dimensions: 1535 x 94 x 76 mm, weight: 1.9 kg.

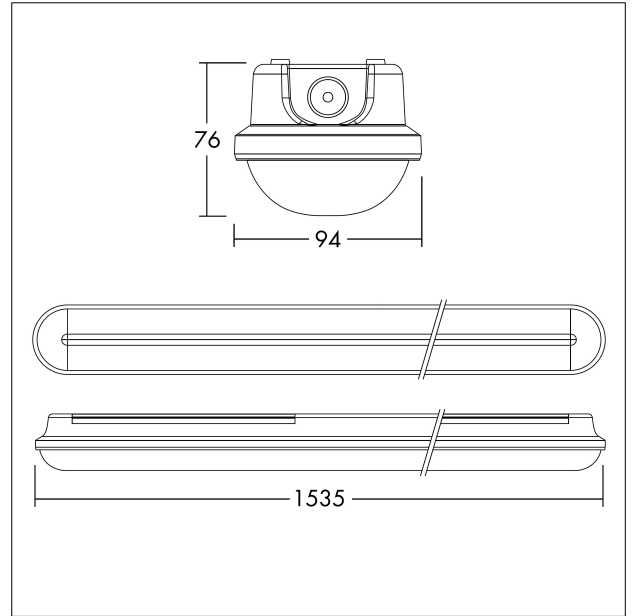

TE_JULIEF_F_PERSP_QC2.jpg



TE_JULIEF_M_1500.wmf

Light Distribution

STD - standard

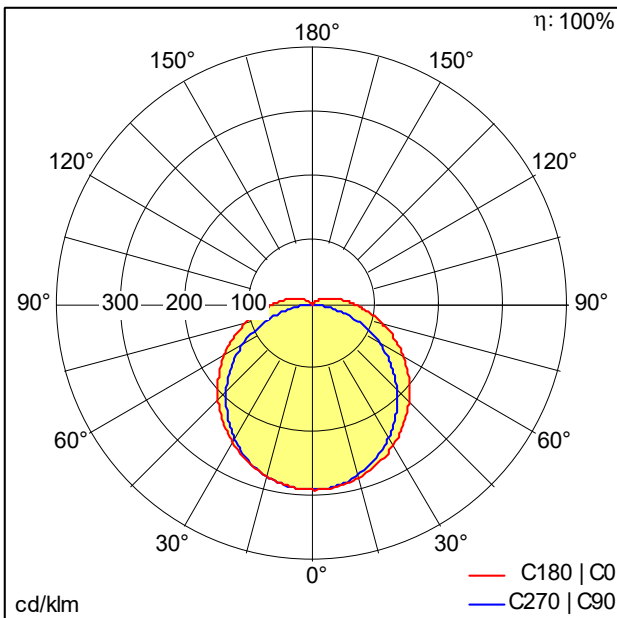

TE_JULIE_FLEX_1500_6300_840_FLEX1.idt

- Light Source: LED
- Luminaire luminous flux*: 6300 lm
- Luminaire efficacy*: 124 lm/W
- Colour Rendering Index min.: 80
- Correlated colour temperature*: 4000 Kelvin
- Chromaticity tolerance (initial MacAdam): 4
- Rated median useful life*: L80 50000 h at 25 °C
- Ballast: 1x LED_Con
- Luminaire input power*: 51 W Power factor = 0.9
- Dimming: Fixed output
- Maintenance category CIE 97: E - Dust-proof IP5X
- Total harmonic distortion (THD): 20.00 %

This product contains a light source of energy efficiency class D.

All values marked with an * are rated values. Connected electrical load and luminous flux are subject to an initial tolerance of +/- 10%, the most similar colour temperature is subject to an initial tolerance of +/- 150K. Unless stated otherwise, the values apply to an ambient temperature of 25°C.