

Confocal Fiber Displacement Sensor Sensor Head ZW-SQ Series

Ultra-compact and Ultra-lightweight Stable Measurements for Any Material

- The slim design measures only 24 × 24 mm. It weighs only 105 g.
- Measuring shiny objects with an inclination of ±8°
- The sensor head has no electronic parts to eliminate problems of electronic and magnetic noise.
- Sampling rate as fast as 80 μs

Note: Angle characteristic and sampling rate differ among models. Please ask OMRON sales representative for details.



System Configuration

EtherCAT connections

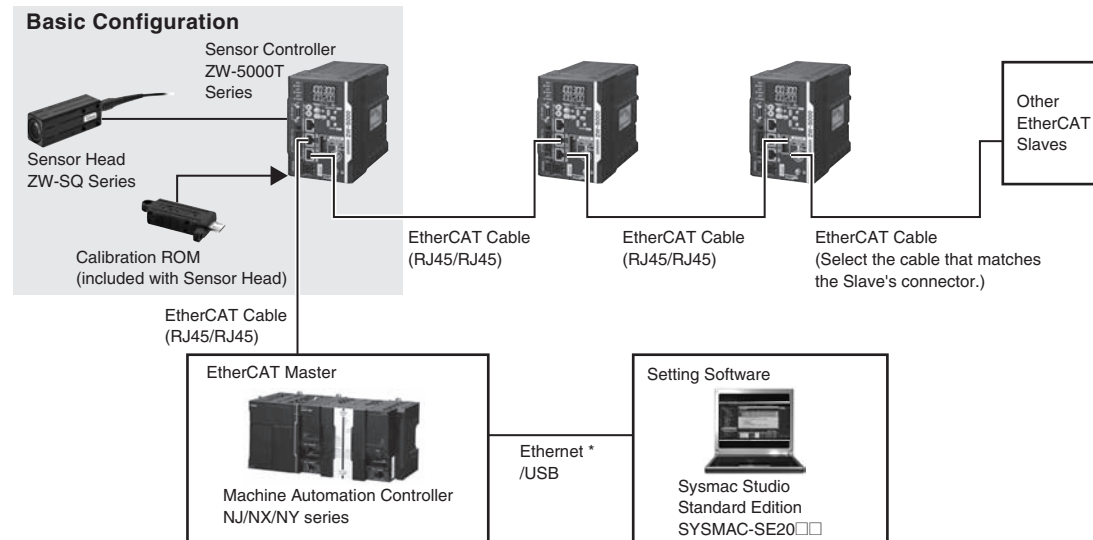

Analog, EtherNet/IP, Ethernet, RS-232C and Parallel connections

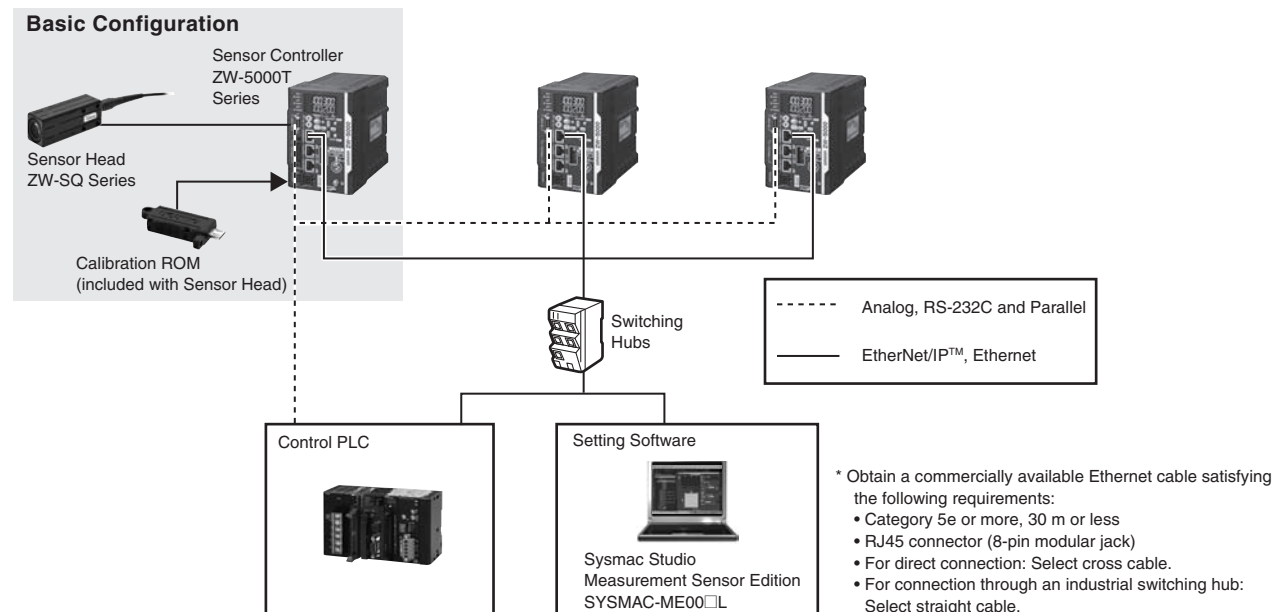

ZW-SQ Series

Order Information



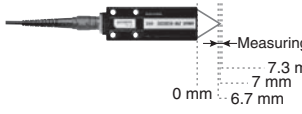
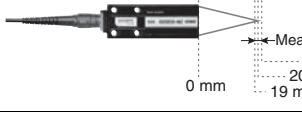
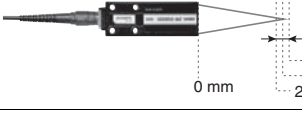
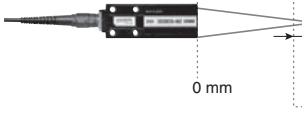

● Sensor Head

Square straight type

Appearance	Measuring range	Spot diameter	Static resolution *	Model
	 <p>Measuring range 7±0.3 mm 7.3 mm 7 mm 6.7 mm 0 mm</p>	18 μm dia.	0.25 μm	ZW-SQ5007 2M
				ZW-SQ5007 0.3M
	 <p>Measuring range 20±1 mm 21 mm 20 mm 19 mm 0 mm</p>	40 μm dia.	0.25 μm	ZW-SQ5020 2M
				ZW-SQ5020 0.3M
	 <p>Measuring range 30±3 mm 33 mm 30 mm 27 mm 0 mm</p>	60 μm dia.	0.25 μm	ZW-SQ5030 2M
				ZW-SQ5030 0.3M
	 <p>Measuring range 40±6 mm 46 mm 40 mm 34 mm 0 mm</p>	80 μm dia.	0.25 μm	ZW-SQ5040 2M
				ZW-SQ5040 0.3M

* Values when the sensor controller ZW-5000T is used.

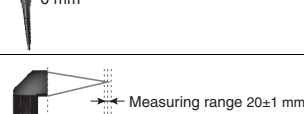
Square Right-angle type



Appearance	Measuring range	Spot diameter	Static resolution *	Model
	 <p>Measuring range 7±0.3 mm 7.3 mm 7 mm 6.7 mm 0 mm</p>	18 μm dia.	0.25 μm	ZW-SQR5007 2M
				ZW-SQR5007 0.3M
	 <p>Measuring range 20±1 mm 21 mm 20 mm 19 mm 0 mm</p>	40 μm dia.	0.25 μm	ZW-SQR5020 2M
				ZW-SQR5020 0.3M
	 <p>Measuring range 40±6 mm 46 mm 40 mm 34 mm 0 mm</p>	80 μm dia.	0.25 μm	ZW-SQR5040 2M
				ZW-SQR5040 0.3M

* Values when the sensor controller ZW-5000T is used.

● Sensor Controller with EtherCAT



Appearance	Power supply	Output type	Model
	24VDC	NPN/PNP	ZW-5000T

● Cable

Appearance	Item	Cable length	Model
	Extension Fiber Cable (from Sensor Head to Sensor Controller), (Fiber Adapter ZW-XFC2 is included)	2 m	ZW-XF5002R
		5 m	ZW-XF5005R
		10 m	ZW-XF5010R
		20 m	ZW-XF5020R
		30 m	ZW-XF5030R
	Fiber Adapter (used between Sensor Head pre-wired cable and Extension Fiber Cable)	-	ZW-XFC2

Note: Extension Fiber Cable ZW-XF50□□R can be used with the firmware version 2.100 or later. If you have an old version sensor controller, register as a Sysmac member and download the latest firmware and tools to update your sensor controller. Refer to the Sysmac member registration sheet that is enclosed with the sensor controller for details on member registration and firmware download.





● Common cables

Appearance	Item	Cable length	Model
	Parallel caable for ZW-5000T 32-pole (included with Sensor Controller ZW-5000T)	2 m	ZW-XCP2E
	RS-232C Cable for personal computer	2 m	ZW-XRS2
	RS-232C Cable for PLC/programmable terminal	2 m	ZW-XPT2

● Recommended EtherCAT Communications Cables

Use Straight STP (shielded twisted-pair) cable of category 5 or higher with double shielding (braiding and aluminum foil tape) for EtherCAT.

● Cable with Connectors

Item	Appearance	Recommended manufacturer	Cable length (m) *1	Model
Standard type Cable with Connectors on Both Ends (RJ45/RJ45) Wire Gauge and Number of Pairs: AWG26, 4-pair Cable Cable Sheath material: LSZH *2 Cable color: Yellow *3		OMRON	0.3	XS6W-6LSZH8SS30CM-Y
			0.5	XS6W-6LSZH8SS50CM-Y
			1	XS6W-6LSZH8SS100CM-Y
			2	XS6W-6LSZH8SS200CM-Y
			3	XS6W-6LSZH8SS300CM-Y
Rugged type Cable with Connectors on Both Ends (RJ45/RJ45) Wire Gauge and Number of Pairs: AWG22, 2-pair Cable		OMRON	0.3	XS5W-T421-AMD-K
			0.5	XS5W-T421-BMD-K
			1	XS5W-T421-CMD-K
			2	XS5W-T421-DMD-K
			5	XS5W-T421-GMD-K
Rugged type Cable with Connectors on Both Ends (M12 Straight/RJ45) Wire Gauge and Number of Pairs: AWG22, 2-pair Cable		OMRON	0.3	XS5W-T421-AMC-K
			0.5	XS5W-T421-BMC-K
			1	XS5W-T421-CMC-K
			2	XS5W-T421-DMC-K
			5	XS5W-T421-GMC-K
Rugged type Cable with Connectors on Both Ends (M12 Right-angle/RJ45) Wire Gauge and Number of Pairs: AWG22, 2-pair Cable		OMRON	0.3	XS5W-T422-AMC-K
			0.5	XS5W-T422-BMC-K
			1	XS5W-T422-CMC-K
			2	XS5W-T422-DMC-K
			5	XS5W-T422-GMC-K
			10	XS5W-T422-JMC-K

Note: For details, refer to Cat.No.G019.

*1. Standard type cables length 0.2, 0.3, 0.5, 1, 1.5, 2, 3, 5, 7.5, 10, 15 and 20m are available.

Rugged type cables length 0.3, 0.5, 1, 2, 3, 5, 10 and 15m are available.

*2. The lineup features Low Smoke Zero Halogen cables for in-cabinet use and PUR cables for out-of-cabinet use.

*3. Cables colors are available in blue, yellow, or Green

● Cables / Connectors

Wire Gauge and Number of Pairs: AWG24, 4-pair Cable

Item	Appearance	Recommended manufacturer	Model
Cables	—	Hitachi Metals, Ltd.	NETSTAR-C5E SAB 0.5 × 4P CP *
	—	Kuramo Electric Co.	KETH-SB *
RJ45 Connectors	—	Panduit Corporation	MPS588-C *

* We recommend to use above cable and connector together.

Wire Gauge and Number of Pairs: AWG22, 2-pair Cable

Item	Appearance	Recommended manufacturer	Model
Cables	—	Kuramo Electric Co.	KETH-PSB-OMR *
	—	JMACS Japan Co.,Ltd.	PNET/B *
RJ45 Assembly Connector		OMRON	XS6G-T421-1 *

Note: Connect both ends of cable shielded wires to the connector hoods.

* We recommend to use above cable and connector together.



ZW-SQ Series

●Industrial switching hubs for Ethernet

Appearance	Number of ports	Current consumption	Model
	5	0.07A	W4S1-05D

Note: Industrial switching hubs are cannot be used for EtherCAT.

●EtherCAT junction slaves

Appearance	Number of ports	Power supply voltage	Current consumption	Model
	3	20.4 to 28.8 VDC (24 VDC 15 to 20%)	0.08A	GX-JC03
	6		0.17A	GX-JC06

Note: 1. Please do not connect EtherCAT junction slave with OMRON position control unit, Model CJ1W-NC□81/□82.
2. EtherCAT junction slaves cannot be used for EtherNet/IP™ and Ethernet.

●Automation Software Sysmac Studio

Please purchase a DVD and required number of licenses the first time you purchase the Sysmac Studio. DVDs and licenses are available individually.

Each model of licenses does not include DVD.

Item	Specifications	Licenses		Model	Standards
		Number of licenses	Media		
Sysmac Studio Standard Edition Ver.1.□□ *3	The Sysmac Studio is the software that provides an integrated environment for setting, programming, debugging and maintenance of machine automation controllers including the NJ/NX-series CPU Units, NY-series Industrial PC, EtherCat Slave, and the HMI. Sysmac Studio runs on the following OS. Windows 7 (32-bit/64-bit version)/Windows 8 (32-bit/64-bit version)/Windows 8.1 (32-bit/64-bit version)/Windows 10 (32-bit/64-bit version)/Windows 11 (64-bit version) *1 This software provides functions of the Measurement Sensor Edition. Refer to your OMRON website for details.	— (Media only)	Sysmac Studio (32bit) DVD	SYSMAC-SE200D	—
		— (Media only)	Sysmac Studio (64bit) DVD	SYSMAC-SE200D-64	—
		1 license *2	—	SYSMAC-SE201L	—
Sysmac Studio Measurement Sensor Edition Ver.1.□□	Sysmac Studio Measurement Sensor Edition is a limited license that provides selected functions required for ZW-series Displacement Sensor settings. Because this product is a license only, you need the Sysmac Standard Edition DVD media to install it.	1 license	—	SYSMAC-ME001L	—
		3 license	—	SYSMAC-ME003L	—

*1. Model "SYSMAC-SE200D-64" runs on Windows 10 (64bit) or higher.

*2. Multiple licenses are available for the Sysmac Studio (3, 10, 30, or 50 licenses).

*3. ZW-5000T is supported by Sysmac Studio version 1.18 or higher.

●Fiber Cleaner

Item	Recommended manufacturer	Model	Applicable Model	Contacts
			ZW-5000	
Fiber Connector Cleaner *1	OMRON	ZW-XCL	Yes	OMRON
OPTIPOP R1	NTT Advanced Technology Corporation	ATC-RE-01	Yes (Sensor Head only)	*2

*1. Place orders in units of boxes (contacting 10 units).

*2. Contacts

[Request for an Estimate]

http://www.ntt-at.com/product/optical_cleaner/Distributors.html

[Request for Information]

NTT Advanced Technology Corporation

Muza Kawasaki Central Tower, 1310 Omiya-cho Saiwai-ku, Kawasaki-shi, Kanagawa, 212-0014, Japan

TEL: +81 44 589 5894

http://www.ntt-at.com/product/optical_cleaner/

Specifications

● Sensor Head

Item	ZW-SQ5007	ZW-SQ5020	ZW-SQ5030	ZW-SQ5040	ZW-SQR5007	ZW-SQR5020	ZW-SQR5040
Sensor Controller	ZW-5000□						
Sensor Head	Square straight type				Square Right-angle type		
Measuring center distance	7 mm	20 mm	30 mm	40 mm	7 mm	20 mm	40 mm
Measuring range	±0.3 mm	±1 mm	±3 mm	±6 mm	±0.3 mm	±1 mm	±6 mm
Static resolution *1	0.25 μm						
Linearity *2	±0.8 μm	±1.2 μm	±4.5 μm	±7.0 μm	±1.1 μm	±1.6 μm	±9.3 μm
Spot diameter *3	Near	20 μm dia.	45 μm dia.	70 μm dia.	90 μm dia.	20 μm dia.	90 μm dia.
	Center	18 μm dia.	40 μm dia.	60 μm dia.	80 μm dia.	18 μm dia.	80 μm dia.
	Far	20 μm dia.	45 μm dia.	70 μm dia.	90 μm dia.	20 μm dia.	90 μm dia.
Measuring cycle *4	80 μs to 1600 μs						
Operating ambient illumination	Illumination on object surface 10,000 lx or less: incandescent light						
Ambient temperature range	Operating: 0 to 50°C, Storage: -15 to 60°C (with no icing or condensation)						
Ambient humidity range	Operating and storage: 35% to 85%RH (with no condensation)						
Degree of protection	IP40 (IEC60529)						
Vibration resistance (destructive)	10 to 150 Hz, 0.35 mm single amplitude, 80 min each in X, Y, and Z directions						
Shock resistance (destructive)	150 m/s ² 3 times each in six directions (up/down, left/right, forward/backward)						
Temperature characteristic *5	0.6 μm/°C	1.5 μm/°C	2.8 μm/°C	4.8 μm/°C	0.6 μm/°C	1.5 μm/°C	4.8 μm/°C
LED Safety	Risk Group 1 (IEC62471)						
Materials	Case: aluminum die-cast Fiber cable sheath: PVC Calibration ROM: PC						
Fiber cable length	0.3 m, 2 m (Flex-resistant cable)						
Fiber cable minimum bending radius	20 mm						
Insulation resistance (Calibration ROM)	Between case and all terminals: 20 MΩ (by 250 V megger)						
Dielectric strength (Calibration ROM)	Between case and all terminals: 1,000 VAC, 50/60 Hz, 1 min						
Weight	Fiber cable length 0.3 m Approx. 100g Fiber cable length 2 m Approx. 105g				Fiber cable length 0.3 m Approx. 125g Fiber cable length 2 m Approx. 130g		
Accessories included with sensor head	Calibration ROM fixing screws (M2 × 5mm) × 1, Fiber protection cap × 1, Strap × 1, Instruction Manual, Precautions						

*1. Capacity value when OMRON standard mirror surface target is measured at the measurement center distance as the average of 16,384 times
The value when the sensor controller ZW-5000T is connected

*2. Material setting for the OMRON standard mirror surface target: Error from an ideal straight line when measuring on mirror surface

*3. Capacity value defined by 1/e² (13.5%) of the peak optical intensity of the measurement wavelength.

*4. When an extension fiber cable of 5 m or longer is connected, the setting range of the measurement cycle (exposure time) changes. For details, refer to *Setting Measurement Cycle* in the *ZW-8000/7000/5000 User's Manual* (Cat. No. Z362).

*5. Capacity value of temperature characteristic at the measurement center distance when fastened with an aluminum jig between the Sensor Head and the target and the Sensor Head and the Sensor Controller are set in the same temperature environment.

ZW-SQ Series

● Sensor Controller

Item		Model	ZW-5000T		
Input/output type			NPN/PNP dual type		
Number of connected sensor heads			1		
Sensor head compatibility			ZW-SQ50□□/SQR50□□		
LED Safety			Risk Group 1 (IEC62471)		
Segment Display	Main display		11-segment white display, 6 digits		
	Sub-display		11-segment green display, 6 digits		
Display	Status indicators		HIGH (orange), PASS (green), LOW (orange), STABILITY (green), ZERO (green), ENABLE (green), THRESHOLD-H (orange), THRESHOLD-L (orange), RUN (green)		
	EtherCAT indicator		ECAT RUN (green), L/A IN (Link/Activity IN) (green), L/A OUT (Link/Activity OUT) (green), ECAT ERR (red)		
External I/F	Ethernet		100BASE-TX/10BASE-T, Non-procedure (TCP/UDP), EtherNet/IP		
	EtherCAT		EtherCAT exclusive protocol 100BASE-TX		
	RS-232C		Max. 115,200 bps		
	Analog output terminal block	Analog voltage output (OUT V)		-10 V to +10 V, output impedance: 100 Ω	
		Analog current output (OUT A)		4 mA to 20 mA, max. load resistance: 300 Ω	
	32-pole expansion connector	Judgment output (HIGH/PASS/LOW)		Transistor output system Output voltage: 21.6 to 30 VDC Load current: 50 mA or less Residual voltage when turning ON: 2 V or less Leakage voltage when turning OFF: 0.1 mA or less	
		Busy output (BUSY)			
		Alarm output (ALARM)			
		Enable output (ENABLE)			
		Sync flag output (SYNFLG)			
		Trigger busy output (TRIGBUSY)			
		Logging state output (LOGSTAT)			
		Logging error output (LOGERR)			
		Stability output (STABILITY)			
		Task state output (TASKSTAT)			
		LIGHT OFF input (LIGHT OFF)			DC input system Input voltage: 24 VDC ± 10% (21.6 to 26.4 VDC) Input current: 7 mA Type. (24 VDC) ON voltage/ON current: 19 V/3 mA or less ON voltage/ON current: 5 V/1 mA or less
		Zero reset input (ZERO)			
Timing input (TIMING)					
Reset input (RESET)					
Sync input (SYNC)					
Trigger input (TRIG)					
Bank	Currently selected bank output (BANK_OUT 1 to 3)		Transistor output system Output voltage: 21.6 to 30 VDC Load current: 50 mA or less Residual voltage when turning ON: 2 V or less Leakage voltage when turning OFF: 0.1 mA or less		
	Bank Selection input (BANK_SEL 1 to 3)		DC input system Input voltage: 24 VDC ± 10% (21.6 to 26.4 VDC) Input current: 7 mA Type. (24 VDC) ON voltage/ON current: 19 V/3 mA or more OFF voltage/OFF current: 5 V/1 mA or less		
Main functions	Exposure time		Automatic/Fixed		
	Measuring cycle *1		80 μs to 1600 μs		
	Material setting		Standard/Mirror/Rough surfaces		
	Measurement item		Height/Thickness of transparent object/Calculation		
	Filtering		Median/Average/Differentiation/High pass/Low pass/Band pass		
	Output		Scaling/Different holds/Zero reset/Logging for a measured value/ Keep, Clamp		
	Display		Measured value/Threshold value/Analog output voltage or current value/Judgment result/Resolution/Light power/Internal logging condition/Peak amount of received light		
	Number of configurable banks		Max. 8 banks (NORMAL mode) Max. 32 banks (JUDGMENT mode)		
	Task process		Multi-task (up to 4 tasks per bank)		
	System		Save/Initialization/Display measured information/Communication settings/Sensor head calibration/Key-lock/Zero reset memory/Timing input		
Rating	Power supply voltage		21.6 to 26.4 VDC (including ripple)		
	Current consumption		800 mA max.		
	Insulation resistance		Across all lead wires and FG terminal: 20 MΩ (by 250 VDC)		
	Dielectric strength		Between all lead wires and FG terminal: 500 VAC, 50/60 Hz, 1 minute		
Environmental resistance	Degree of protection		IP20 (IEC60529)		
	Vibration resistance (destructive)		10 to 55 Hz (half amplitude 0.35 mm), 50 mins in each of X/Y/Z directions		
	Shock resistance (destructive)		150 m/s ² , 6 direction, 3 times each (up/down, left/right, forward/backward)		
	Ambient temperature range		Operation: 0 to 40°C, Storage: -15 to +60°C (No freezing and condensation)		
	Ambient humidity range		Operation/storage: 35 to 85%RH (No condensation)		
Grounding			D-type grounding (grounding resistance of 100 Ω or less) Note: For conventional Class D grounding		
Material			Chassis: PC		
Weight			Approx. 900g (main unit only), Approx. 150 g (Parallel cable)		
Accessories			Parallel cable × 1 (ZW-XCP2E) 10 Fiber cleaners × 1 (ZW-XCL) Fiber adapter cap × 1, Strap × 1 Instruction Manual, Member registration sheet, Precautions		

Note: The Export Trade Control Order compatible Sensor Controller (ZW-5000T) is available.

When using this Sensor Controller, the minimum resolution is 0.25 μm regardless of the connected Sensor Head and setting conditions.

*1. When an extension fiber cable of 5 m or longer is connected, the setting range of the measurement cycle (exposure time) changes. For details, refer to *Setting Measurement Cycle* in the ZW-8000/7000/5000 User's Manual (Cat. No. Z362).

●EtherCAT Communications Specifications

Item	Specification
Communications standard	IEC61158 Type12
Physical layer	100BASE-TX(IEEE802.3)
Connectors	RJ45 × 2 ECAT IN: EtherCAT input ECAT OUT: EtherCAT output
Communications media	Category 5 or higher (cable with double, aluminum tape and braided shielding) is recommended.
Communications distance	Distance between nodes: 100 m max.
Process data	Variable PDO mapping
Mailbox (CoE)	Emergency messages, SDO requests, SDO responses, and SDO information
Distributed clock	Synchronization in DC mode.
LED display	L/A IN (Link/Activity IN) × 1, AL/A OUT (Link/Activity OUT) × 1, AECAT RUN × 1, AECAT ERR × 1

●Automation Software Sysmac Studio

Item	Operating environment *3
Operating system (OS) *1	Windows 7 SP1 (32-bit/64-bit version)/Windows 8.1 (32-bit/64-bit version)/ Windows 10(32-bit/64-bit version)/Windows 11 (64-bit version)
CPU	Windows computers with Intel® Celeron® processor 540 (1.8 GHz) or faster CPU. Intel® Core™ i5 M520 processor (2.4 GHz) or equivalent or faster recommended.
Main memory	2 GB min. 4 GB min. recommended
Hard disk	Minimum 4.6 GB of Hard disk space is required to install. *2
Display	XGA 1024 × 768, 16 million colors. WXGA 1280 × 800 dots or higher resolution is recommended.
Disk drive	DVD-ROM drive
Communications ports	USB port corresponded to USB 2.0, or Ethernet port *4
Supported languages	Japanese, English, German, French, Italian, Spanish, simplified Chinese, traditional Chinese, Korean

*1. Note about Sysmac Studio compatible operating systems: The required system and hard disk capacity differs according to the system environment.

*2. Separate logging memory is required to use the file logging function.

*3. Describes System Requirements and notes of Sysmac Studio Measurement Sensor Edition.

For detail of System Requirements and notes of Sysmac Studio Measurement Sensor Edition, refer to Sysmac Studio Version 1 Operation Manual.

*4. For information on how to connect a personal computer with the sensor controller or other hardware and information on required cables, refer to manuals for each hardware.

●Version Information

Sensor Head/Cable, Sensor Controller, and Sysmac Studio

The applicable version of the Sensor Controller varies depending on the Sensor Head or Cable. The versions are listed below.

Use the latest version of Sysmac Studio Standard Edition/Measurement Sensor Edition.

Sensor head/Cable		ZW Series	Version of Sensor Controller	Corresponding version of Sysmac Studio Standard Edition/Measurement Sensor Edition
Type	Model			
Square straight type	ZW-SQ50□□□M	ZW-5000T	Version 2.110 or later	Version 1.18 or higher
Square Right-angle type	ZW-SQR50□□□M			
Extension Fiber Cable	ZW-XF50□□□R		Version 2.100 or later	

Note: Refer to the *Firmware Update in the ZW-8000/7000/5000 User's Manual* (Cat. No. Z362) for how to update the Sensor Controller.

ZW-SQ Series

External Dimensions

(Unit: mm)

Sensor Head Square straight type

ZW-SQ5007 □M/-SQ5020 □M/-SQ5030 □M/-SQ5040 □M

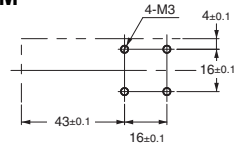

MOUNTING SCREW HOLES

*1.

Type	W.D.	M	X
ZW-SQ5007	7	0.3	12
ZW-SQ5020	20	1	11.8
ZW-SQ5030	30	3	11.7
ZW-SQ5040	40	6	11.7

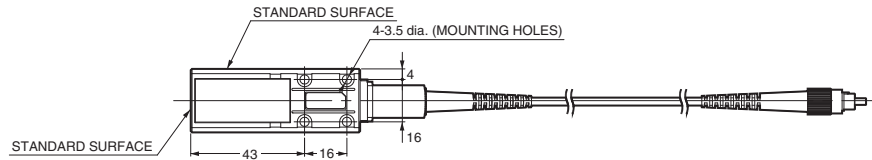

*2.

Length	L
0.3 m	300+40/0
2 m	2000+40/0

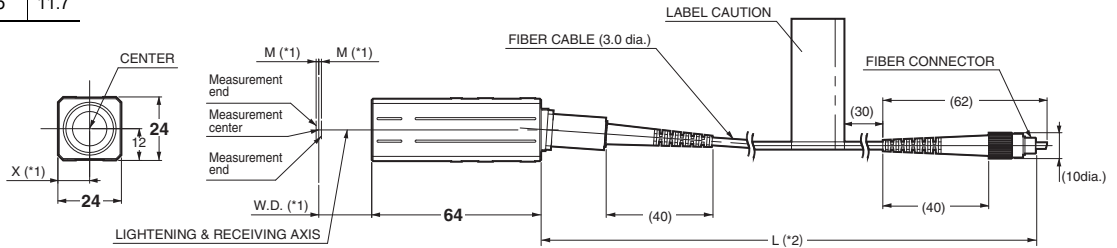

Square Right-angle type

ZW-SQR5007 □M/-SQR5020 □M/-SQR5040 □M

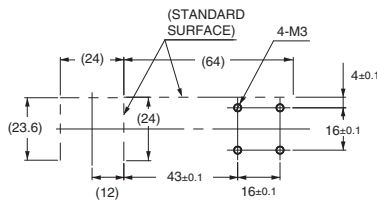

MOUNTING SCREW HOLES

*1.

Type	W.D.	M
ZW-SQR5007	7	0.3
ZW-SQR5020	20	1
ZW-SQR5040	40	6

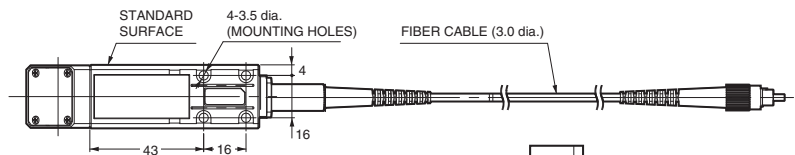

*2.

Length	L
0.3 m	300+40/0
2 m	2000+40/0

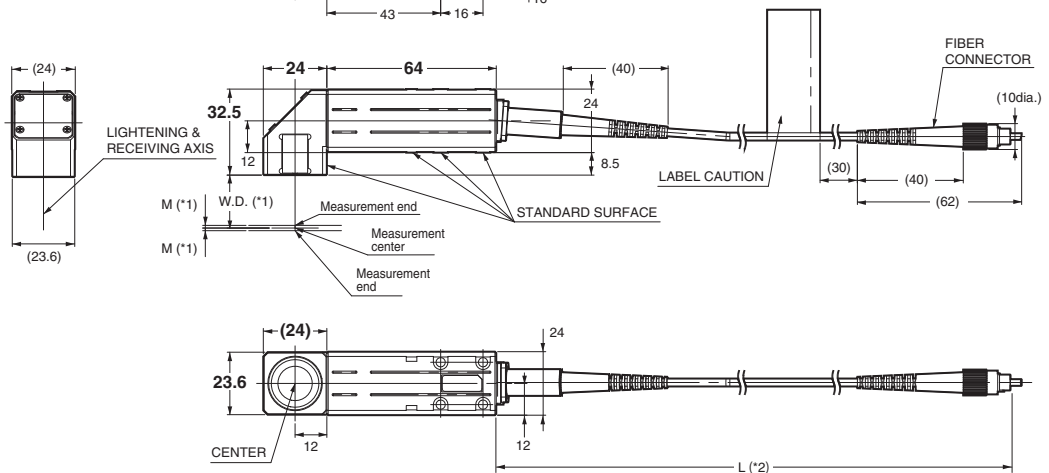

Sensor Controller

ZW-5000T

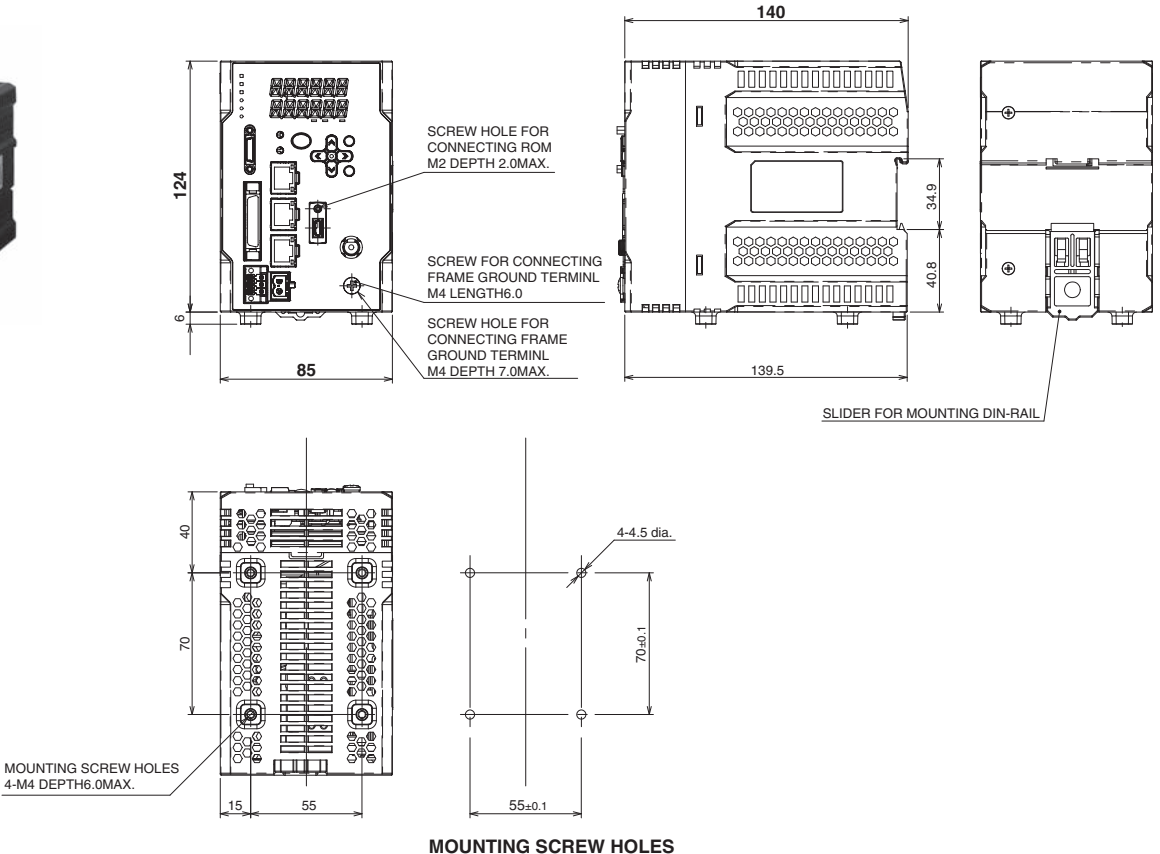

Extension Fiber Cable

ZW-XF5002R/XF5005R/XF5010R/XF5020R/XF5030R

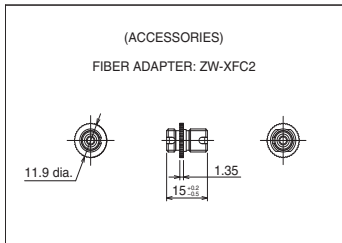
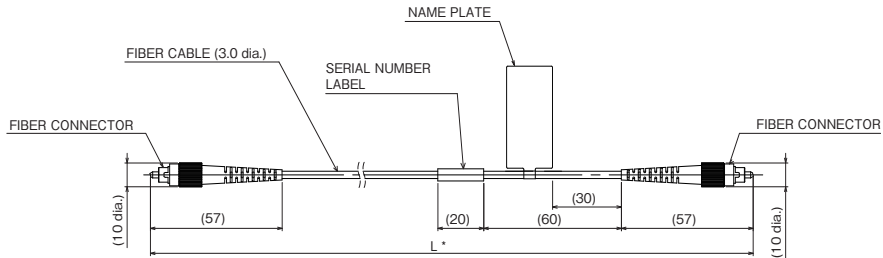

* The following table lists cable lengths per models.

Type	Specification	L
ZW-XF5002R	2m	2000+200/0
ZW-XF5005R	5m	5000+200/0
ZW-XF5010R	10m	10000+200/0
ZW-XF5020R	20m	20000+500/0
ZW-XF5030R	30m	30000+500/0

Related Manuals

Man.No.	Model number	Manual
Z362	ZW-800□/700□/500□	Displacement Sensor ZW-8000/7000/5000 User's Manual
Z363	ZW-800□/700□/500□	Displacement Sensor ZW-8000/7000/5000 User's Manual for Communications Settings
W504	SYSMAC-SE2	Sysmac Studio Version 1 Operation Manual

- Angle characteristic, linearity, sampling period and spot diameter given in the cover differ among models. Please ask Omron sales representative for details.
- EtherCAT® is registered trademark and patented technology, licensed by Beckhoff Automation GmbH, Germany.
- EtherNet/IP™ is a trademark of ODVA.
- Sysmac is a trademark or registered trademark of OMRON Corporation in Japan and other countries for OMRON factory automation products.
- Windows is a registered trademark of Microsoft Corporation in the USA and other countries.
- Other company names and product names mentioned in this document are the trademarks or registered trademarks of their respective companies.

Note: Do not use this document to operate the Unit.

OMRON Corporation Industrial Automation Company

Kyoto, JAPAN

Contact : www.ia.omron.com

Regional Headquarters

OMRON EUROPE B.V.

Wegalaan 67-69, 2132 JD Hoofddorp
The Netherlands
Tel: (31) 2356-81-300 Fax: (31) 2356-81-388

OMRON ELECTRONICS LLC

2895 Greenspoint Parkway, Suite 200
Hoffman Estates, IL 60169 U.S.A.
Tel: (1) 847-843-7900 Fax: (1) 847-843-7787

OMRON ASIA PACIFIC PTE. LTD.

438B Alexandra Road, #08-01/02 Alexandra
Technopark, Singapore 119968
Tel: (65) 6835-3011 Fax: (65) 6835-2711

OMRON (CHINA) CO., LTD.

Room 2211, Bank of China Tower,
200 Yin Cheng Zhong Road,
PuDong New Area, Shanghai, 200120, China
Tel: (86) 21-5037-2222 Fax: (86) 21-5037-2200

Authorized Distributor:

©OMRON Corporation 2018-2023 All Rights Reserved.
In the interest of product improvement,
specifications are subject to change without notice.

CSM_8_1

Cat. No. Q260-E1-08 0123 (0418)