

E6F-A

Rugged Rotary Encoder

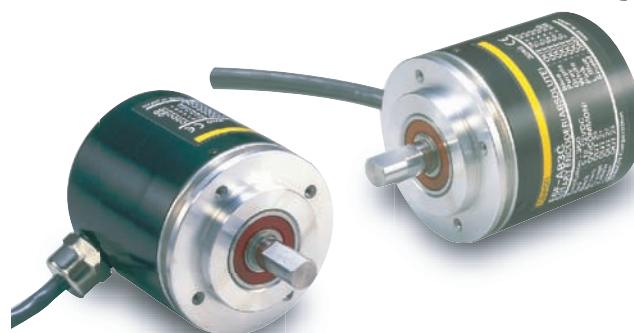

- Absolute model.
- External diameter of 60 mm.
- Resolution of up to 1,024 (10-bit).
- IP65 oil-proof protection.
- Strong shaft.
Radial: 120 N, Thrust: 50 N



Be sure to read *Safety Precautions* on page 5.

For the most recent information on models that have been certified for safety standards, refer to your OMRON website.

Ordering Information

Encoders [Refer to *Dimensions* on page 6.]

Power supply voltage	Output configuration	Output code	Resolution (divisions)	Connection method	Model
5 to 12 VDC	NPN open collector	BCD	360	Pre-wired Model	E6F-AB3C 360P/R 2M *2
				Pre-wired Connector Model (2 m)	E6F-AB3C-C 360P/R 2M *2
				Pre-wired Model	E6F-AB5C 360P/R 2M
				Pre-wired Connector Model (2 m)	E6F-AB5C-C 360P/R 2M
12 to 24 VDC	PNP open collector	Gray code	256, 360, 720	Pre-wired Model	E6F-AB5B 360P/R 2M
	NPN open collector			Pre-wired Connector Model (2 m)	E6F-AG5C-C (resolution) 2M *1 Example: E6F-AG5C-C 256P/R 2M
	PNP open collector		256, 360, 720, 1,024	Pre-wired Model	E6F-AG5C (resolution) 2M Example: E6F-AG5C 256P/R 2M
			E6F-AG5B (resolution) 2M Example: E6F-AG5B 256P/R 2M		

*1. The E6F-AG5C-C is designed for connection to Cam Positioners (H8PS).

*2. Models are also available with 5-m cables.

Accessories (Order Separately)

[Dimensions: Refer to *Accessories* for coupling dimensions and to page 6 for the dimensions of other accessories.]

Name	Model	Remarks
Couplings	E69-C10B	Provided with E6F Pre-wired Models.
	E69-C610B	Different end diameter
	E69-C10M	Metal construction
Servo Mounting Bracket	E69-2	Provided with the product. (Three brackets in a set.)
Extension Cable	E69-DF5	5 m
	E69-DF10	10 m
	E69-DF20	20 m

Refer to *Accessories* for details.

Ratings and Specifications

Item	Model	E6F-AB3C-C	E6F-AB3C	E6F-AB5C-C	E6F-AB5C	E6F-AB5B	E6F-AG5C-C	E6F-AG5C	E6F-AG5B	
Power supply voltage		5 VDC -5% to 12 VDC +10%, ripple (p-p): 5% max.		12 VDC -10% to 24 VDC +15%, ripple (p-p): 5% max.						
Current consumption*1		60 mA max.								
Resolution (pulses/rotation)*2		360					256, 360, 720		256, 360, 720, 1024	
Output code		BCD					Gray code			
Output configuration		NPN open-collector output				PNP open-collector output	NPN open-collector output		PNP open-collector output	
Output capacity		Applied voltage: 30 VDC max. Sink current: 35 mA max. Residual voltage: 0.4 V max. (at sink current of 35 mA)				Source current: 35 mA max. Residual voltage: 0.4 V max. (at source current of 35 mA)	Applied voltage: 30 VDC max. Sink current: 35 mA max. Residual voltage: 0.4 V max. (at sink current of 35 mA)		Source current: 35 mA max. Residual voltage: 0.4 V max. (at source current of 35 mA)	
Maximum response frequency*3		10 kHz					20 kHz			
Logic		Negative logic (high = 0, low = 1)				Positive logic (high = 1, low = 0)	Negative logic (high = 0, low = 1)		Positive logic (high = 1, low = 0)	
Direction of rotation		Output code incremented by CW (as viewed from the end of the shaft)								
Rise and fall times of output		1 μs max. (E6F-AB3C, A□5C: Load voltage: 5 V, Load resistance: 1 kΩ, Output cable: 2 m max.; E6F-A□5B: Power supply voltage: 12 V, Load resistance: 1 kΩ, Output cable: 2 m max.)								
Starting torque		9.8 mN·m max. at room temperature, 14.7 mN·m max. at low temperature								
Moment of inertia		1.5×10^{-6} kg·m ² max.								
Shaft loading	Radial	120 N								
	Thrust	50 N								
Maximum permissible speed		5000 r/min								
Ambient temperature range		Operating: -10 to 70°C (with no icing), Storage: -25 to 80°C (with no icing)								
Ambient humidity range		Operating: 35% to 85% (with no condensation), Storage: 35% to 95% (with no condensation)								
Insulation resistance		20 MΩ min. (at 500 VDC) between current-carrying parts and case								
Dielectric strength		500 VAC, 50/60 Hz for 1 min between current-carrying parts and case								
Vibration resistance		10 to 500 Hz, 2-mm double amplitude for 11 min 3 times each in X, Y, and Z directions								
Shock resistance		Destruction: 1,000 m/s ² 3 times each in X, Y, and Z directions								
Degree of protection		IEC 60529 IP65, in-house standards: oilproof								
Connection method		Connector Models (Standard cable length: 2 m)	Pre-wired Models (Standard cable length: 2 m)	Connector Models (Standard cable length: 2 m)	Pre-wired Models (Standard cable length: 2 m)		Connector Models (Standard cable length: 2 m)	Pre-wired Models (Standard cable length: 2 m)		
Material		Case: Zinc alloy, Main unit: Aluminum, Shaft: SUS420J2, Mounting Bracket: Galvanized iron								
Weight (packed state)		Approx. 500 g								
Accessories		Servo Mounting Bracket, Coupling (provided with Pre-wired Models only), Hexagonal wrench (provided with Pre-wired Models only), Instruction manual								

*1. An inrush current of approximately 9 A will flow for approximately 5 μs when the power is turned ON.

*2. The code is as follows:

Output code	Resolution	Code No.
BCD	360	0 to 359
	256	0 to 255
Gray code	360	76 to 435 (gray after 76)
	720	152 to 871 (gray after 152)
	1024	0 to 1023

*3. The maximum electrical response speed is determined by the resolution and maximum response frequency as follows:

$$\text{Maximum electrical response speed (rpm)} = \frac{\text{Maximum response frequency}}{\text{Resolution}} \times 60$$

* This means that the Rotary Encoder will not operate electrically if its speed exceeds the maximum electrical response speed.

I/O Circuit Diagrams

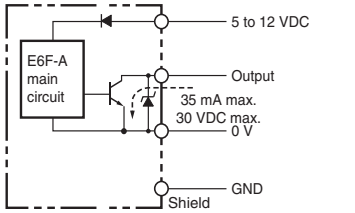
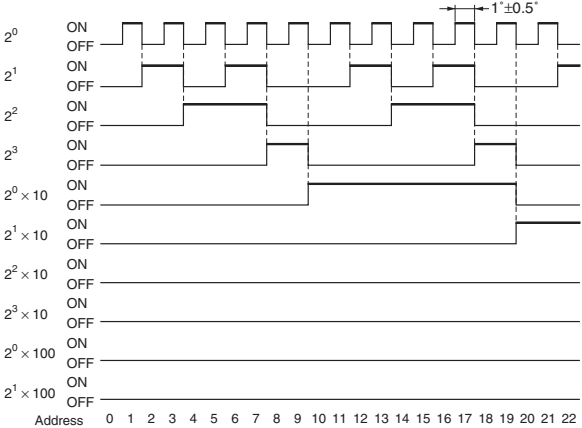
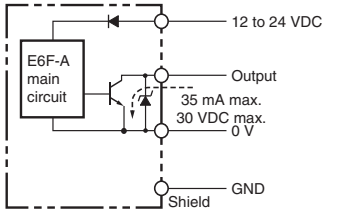
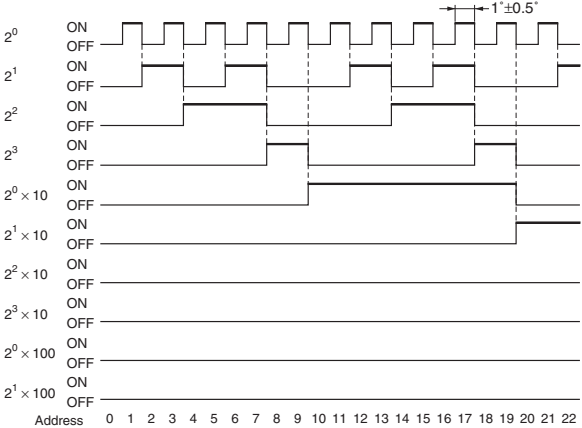
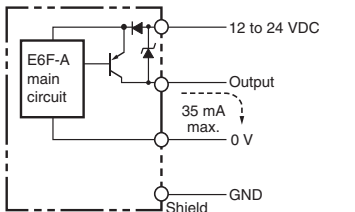
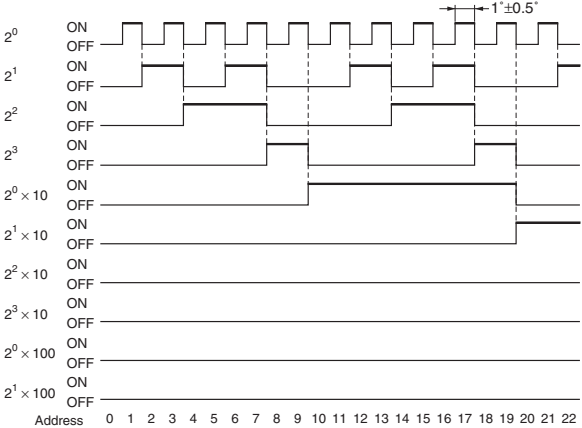
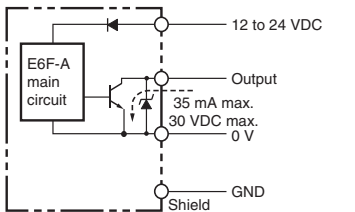
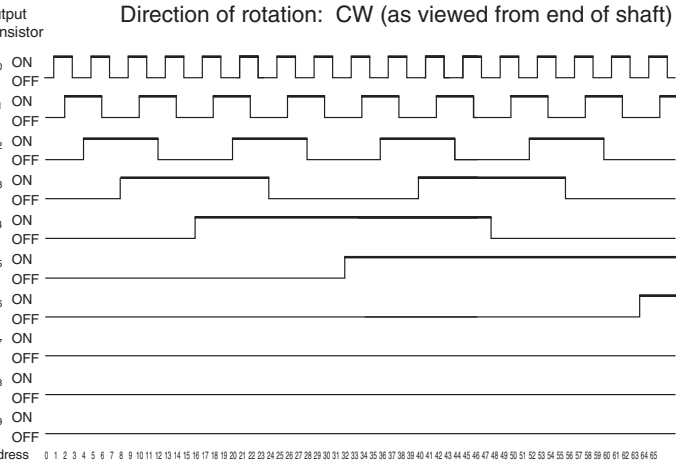
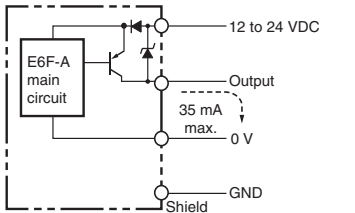
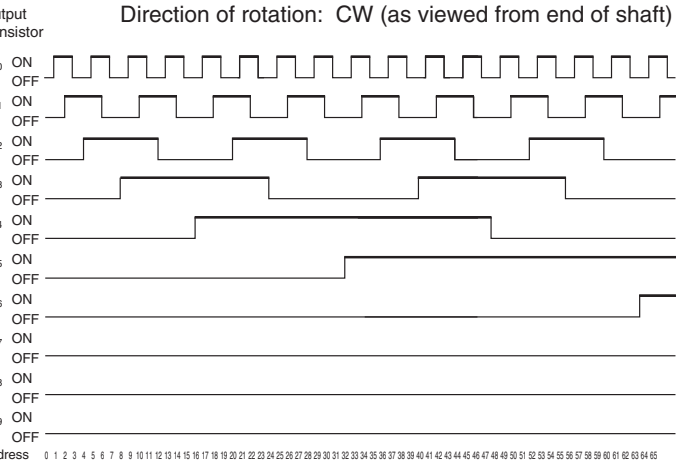
Model	Output Circuits	Output mode
<p>E6F-AB3C E6F-AB3C-C</p>	 <p>Note: The circuit is the same for all bit outputs. Each E6F-A Rotary Encoder has one main circuit.</p>	<p>Direction of rotation: CW (as viewed from end of shaft)</p> 
<p>E6F-AB5C E6F-AB5C-C</p>	 <p>Note: The circuit is the same for all bit outputs. Each E6F-A Rotary Encoder has one main circuit.</p>	<p>Direction of rotation: CW (as viewed from end of shaft)</p> 
<p>E6F-AB5B</p>	 <p>Note: The circuit is the same for all bit outputs. Each E6F-A Rotary Encoder has one main circuit.</p>	<p>Direction of rotation: CW (as viewed from end of shaft)</p> 
<p>E6F-AG5C E6F-AG5C-C</p>	 <p>Note: The circuit is the same for all bit outputs. Each E6F-A Rotary Encoder has one main circuit.</p>	<p>Direction of rotation: CW (as viewed from end of shaft)</p> 
<p>E6F-AG5B</p>	 <p>Note: The circuit is the same for all bit outputs. Each E6F-A Rotary Encoder has one main circuit.</p>	<p>Direction of rotation: CW (as viewed from end of shaft)</p> 

Connection Specifications

Connector Models*

Model	E6F-AG5C-C			
	E6F-AB3C-C/ -AB5C-C		E6F-AG5C-C	
Pin No.	Output signal		Output signal	
	10-bit (360)	8-bit (256)	9-bit (360)	10-bit (720)
1	2 ⁰	Connected internally	Not connected	2 ⁹
2	2 ¹		2 ⁸	2 ⁸
3	2 ²	2 ⁵	2 ⁵	2 ⁵
4	2 ³	2 ¹	2 ¹	2 ¹
5	2 ⁰ × 10	2 ⁰	2 ⁰	2 ⁰
6	2 ¹ × 10	2 ⁷	2 ⁷	2 ⁷
7	2 ² × 10	2 ⁴	2 ⁴	2 ⁴
8	2 ³ × 10	2 ²	2 ²	2 ²
9	2 ⁰ × 100	2 ³	2 ³	2 ³
10	2 ¹ × 100	2 ⁶	2 ⁶	2 ⁶
11	Shield (ground)			
12	-AB3C-C: 5 to 12 VDC, -AB5C-C: 12 to 24 VDC	12 to 24 VDC		
13	0 V (common)	0 V (common)		

* Connector: RP13A-12PD-13SC (Hirose Electric Co., Ltd.)
Note: Normally connect GND to 0 V or to an external ground.

Pre-wired Model

Model	E6F-AG5C/-AG5B			
	E6F-AB3C/ -AB5C/-AB5B		E6F-AG5C/-AG5B	
Wire color	Output signal		Output signal	
	10-bit (360)	8-bit (256)	9-bit (360)	10-bit (720,1024)
Brown	2 ⁰	2 ⁰	2 ⁰	2 ⁰
Orange	2 ¹	2 ¹	2 ¹	2 ¹
Yellow	2 ²	2 ²	2 ²	2 ²
Green	2 ³	2 ³	2 ³	2 ³
Blue	2 ⁰ × 10	2 ⁴	2 ⁴	2 ⁴
Purple	2 ¹ × 10	2 ⁵	2 ⁵	2 ⁵
Gray	2 ² × 10	2 ⁶	2 ⁶	2 ⁶
White	2 ³ × 10	2 ⁷	2 ⁷	2 ⁷
Pink	2 ⁰ × 100	Not connected	2 ⁸	2 ⁸
Light blue	2 ¹ × 100	Not connected	Not connected	2 ⁹
---	Shield (ground)	Shield (ground)		
Red	-AB3C: 5 to 12 VDC, -AB5C: 12 to 24 VDC	12 to 24 VDC		
Black	0 V (common)	0 V (common)		

Connection Example

H8PS Cam Positioner Connection

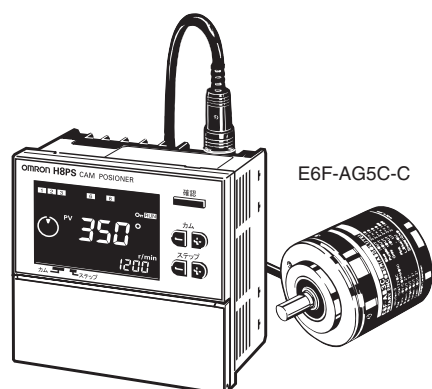

Ordering Information

Model
H8PS-8A
H8PS-8AP
H8PS-8AF
H8PS-8AFP
H8PS-16A
H8PS-16AP
H8PS-16AF
H8PS-16AFP
H8PS-32A
H8PS-32AP
H8PS-32AF
H8PS-32AFP

Specifications

Rated voltage	24 VDC
Cam precision	0.5° (for 720 resolution), 1° (for 256/360 resolution)
No. of output points	8-point output type: 8 cam outputs, 1 RUN output, 1 pulse output 16-point output type: 16 cam outputs, 1 RUN output, 1 pulse output 32-point output type: 32 cam outputs, 1 RUN output, 1 pulse output
Encoder response	RUN mode, test mode: 256/360 resolution ... 1,600 r/min max. (1,200 r/min when advance compensation is set for four cams or more) 720 resolution 800 r/min max. (600 r/min when advance compensation is set for four cams or more)
Additional functions	<ul style="list-style-type: none"> • Origin compensation (zeroing) • Rotation direction switching • Angle display switching • Teaching • Pulse output • Angle/number of rotations display switching • Puncture * • Angle advance • Number of rotations alarm output • Setting with support software (order separately) *

Note: For 16-point and 32-point output types only

Safety Precautions

Refer to *Warranty and Limitations of Liability*.

 **WARNING**

This product is not designed or rated for ensuring safety of persons either directly or indirectly. Do not use it for such purposes.



Precautions for Correct Use

Do not use the Encoder under ambient conditions that exceed the ratings.

● Adjustment

Reading the Output Code

Read the code after the LSB (output 2⁰) of the code changes for the E6F-AB3C and E6F-AB3C-C.

● Wiring

Spurious pulses may be generated when power is turned ON and OFF. Wait at least 0.1 s after turning ON the power to the Encoder before using the connected device, and stop using the connected device at least 0.1 s before turning OFF the power to the Encoder. Also, turn ON the power to the load only after turning ON the power to the Encoder.

Dimensions

Tolerance class IT16 applies to dimensions in this datasheet unless otherwise specified.

Encoder

E6F-AB3C
E6F-AB5C
E6F-AG5C
E6F-AG5B
E6F-AB5B

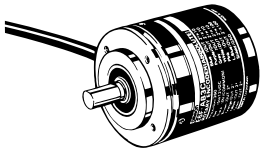

The E69-C10B Coupling is provided.

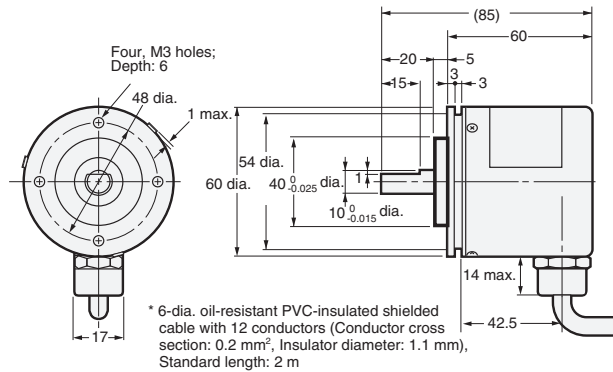

E6F-AB3C-C
E6F-AB5C-C
E6F-AG5C-C

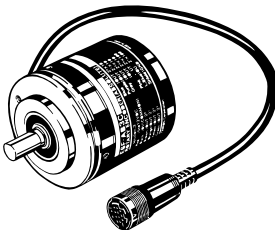

The E69-C10B Coupling is sold separately.

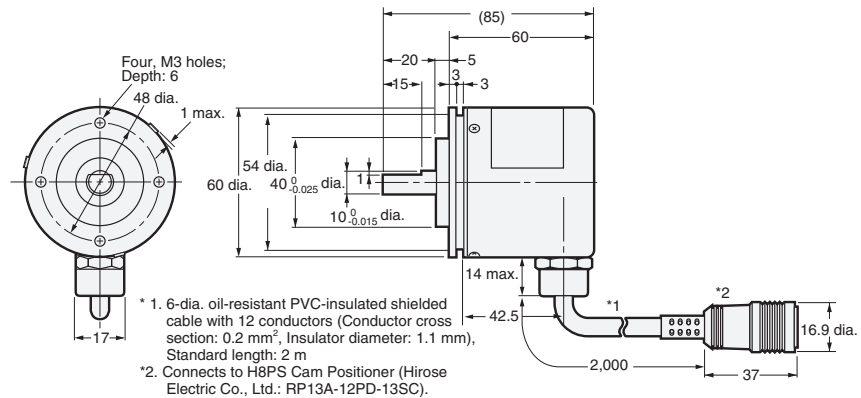

Accessories (Order Separately)

Servo Mounting Bracket

E69-2

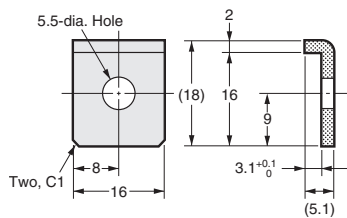

Note: Provided with the product.

Mounting Bracket Installation

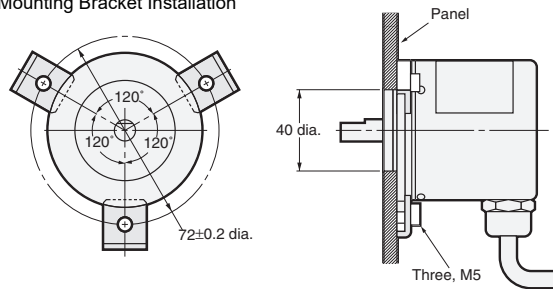

Extension Cable

E69-DF5

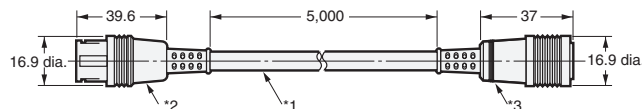
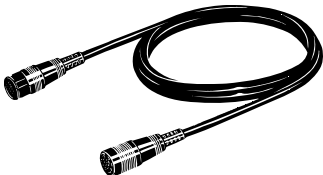

*1. 6-dia. shielded cable with 12 conductors (Conductor cross section: 0.2 mm², Insulator diameter: 1.1 mm), Standard length: 5 m

*2. Connects to connector on E6F-AB3C-C or E6F-AG5C-C.

*3. Connects to H8PS Cam Positioner.

Note: 1. The E69-DF5 (5 m) is also available with the following cable lengths: 10 m, 15 m, 20 m, and 98 m.

2. Cable can be extended to 100 m when the H8PS Cam Positioner is connected.

Couplings

E69-C10B
E69-C610B
E69-C10M

Refer to *Accessories* for details.

Terms and Conditions Agreement

Read and understand this catalog.

Please read and understand this catalog before purchasing the products. Please consult your OMRON representative if you have any questions or comments.

Warranties.

(a) Exclusive Warranty. Omron's exclusive warranty is that the Products will be free from defects in materials and workmanship for a period of twelve months from the date of sale by Omron (or such other period expressed in writing by Omron). Omron disclaims all other warranties, express or implied.

(b) Limitations. OMRON MAKES NO WARRANTY OR REPRESENTATION, EXPRESS OR IMPLIED, ABOUT NON-INFRINGEMENT, MERCHANTABILITY OR FITNESS FOR A PARTICULAR PURPOSE OF THE PRODUCTS. BUYER ACKNOWLEDGES THAT IT ALONE HAS DETERMINED THAT THE PRODUCTS WILL SUITABLY MEET THE REQUIREMENTS OF THEIR INTENDED USE.

Omron further disclaims all warranties and responsibility of any type for claims or expenses based on infringement by the Products or otherwise of any intellectual property right. (c) Buyer Remedy. Omron's sole obligation hereunder shall be, at Omron's election, to (i) replace (in the form originally shipped with Buyer responsible for labor charges for removal or replacement thereof) the non-complying Product, (ii) repair the non-complying Product, or (iii) repay or credit Buyer an amount equal to the purchase price of the non-complying Product; provided that in no event shall Omron be responsible for warranty, repair, indemnity or any other claims or expenses regarding the Products unless Omron's analysis confirms that the Products were properly handled, stored, installed and maintained and not subject to contamination, abuse, misuse or inappropriate modification. Return of any Products by Buyer must be approved in writing by Omron before shipment. Omron Companies shall not be liable for the suitability or unsuitability or the results from the use of Products in combination with any electrical or electronic components, circuits, system assemblies or any other materials or substances or environments. Any advice, recommendations or information given orally or in writing, are not to be construed as an amendment or addition to the above warranty.

See <http://www.omron.com/global/> or contact your Omron representative for published information.

Limitation on Liability: Etc.

OMRON COMPANIES SHALL NOT BE LIABLE FOR SPECIAL, INDIRECT, INCIDENTAL, OR CONSEQUENTIAL DAMAGES, LOSS OF PROFITS OR PRODUCTION OR COMMERCIAL LOSS IN ANY WAY CONNECTED WITH THE PRODUCTS, WHETHER SUCH CLAIM IS BASED IN CONTRACT, WARRANTY, NEGLIGENCE OR STRICT LIABILITY.

Further, in no event shall liability of Omron Companies exceed the individual price of the Product on which liability is asserted.

Suitability of Use.

Omron Companies shall not be responsible for conformity with any standards, codes or regulations which apply to the combination of the Product in the Buyer's application or use of the Product. At Buyer's request, Omron will provide applicable third party certification documents identifying ratings and limitations of use which apply to the Product. This information by itself is not sufficient for a complete determination of the suitability of the Product in combination with the end product, machine, system, or other application or use. Buyer shall be solely responsible for determining appropriateness of the particular Product with respect to Buyer's application, product or system. Buyer shall take application responsibility in all cases.

NEVER USE THE PRODUCT FOR AN APPLICATION INVOLVING SERIOUS RISK TO LIFE OR PROPERTY OR IN LARGE QUANTITIES WITHOUT ENSURING THAT THE SYSTEM AS A WHOLE HAS BEEN DESIGNED TO ADDRESS THE RISKS, AND THAT THE OMRON PRODUCT(S) IS PROPERLY RATED AND INSTALLED FOR THE INTENDED USE WITHIN THE OVERALL EQUIPMENT OR SYSTEM.

Programmable Products.

Omron Companies shall not be responsible for the user's programming of a programmable Product, or any consequence thereof.

Performance Data.

Data presented in Omron Company websites, catalogs and other materials is provided as a guide for the user in determining suitability and does not constitute a warranty. It may represent the result of Omron's test conditions, and the user must correlate it to actual application requirements. Actual performance is subject to the Omron's Warranty and Limitations of Liability.

Change in Specifications.

Product specifications and accessories may be changed at any time based on improvements and other reasons. It is our practice to change part numbers when published ratings or features are changed, or when significant construction changes are made. However, some specifications of the Product may be changed without any notice. When in doubt, special part numbers may be assigned to fix or establish key specifications for your application. Please consult with your Omron's representative at any time to confirm actual specifications of purchased Product.

Errors and Omissions.

Information presented by Omron Companies has been checked and is believed to be accurate; however, no responsibility is assumed for clerical, typographical or proofreading errors or omissions.