

SURFACE CIRCULAR 500

SURFACE CIRCULAR 500 SENSOR

SURFACE CIRCULAR 500 DALI

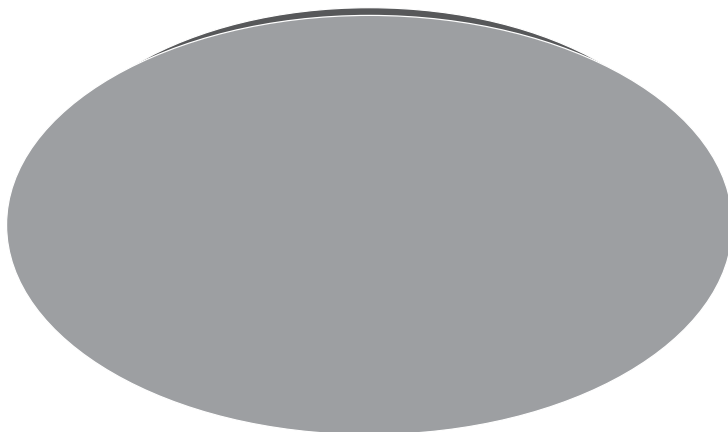

	EAN	Ø x h [mm]	W	EM W* (230V DC)	V _{AC}	Hz	lm	lm/W	EM lm* (230V DC)
SF CIRC 500 V 42W 830 IP44 PS	4099854042119	500x105	42**	–	220-240	50/60	3500**	83	–
SF CIRC 500 V 42W 840 IP44 PS	4099854042133	500x105	42**	–	220-240	50/60	3500**	83	–
SF CIRC 500 SEN V 42W 830 IP44 PS	4099854042157	500x105	42**	–	220-240	50/60	3500**	83	–
SF CIRC 500 SEN V 42W 840 IP44 PS	4099854042171	500x105	42**	–	220-240	50/60	3500**	83	–
SF CIRC 500 V 42W 830 IP44 DALI	4099854077890	500x105	42	6	220-240 V	0/50/60	3500	83	550
SF CIRC 500 V 42W 840 IP44 DALI	4099854077913	500x105	42	6	220-240 V	0/50/60	3500	83	550

	EAN	K	IP	IK	∇	R _a	⌈ (°C)	PF	👤
SF CIRC 500 V 42W 830 IP44 PS	4099854042119	3000	44	03	120°	> 80	-20...+45	> 0.9	1.2 kg
SF CIRC 500 V 42W 840 IP44 PS	4099854042133	4000	44	03	120°	> 80	-20...+45	> 0.9	1.2 kg
SF CIRC 500 SEN V 42W 830 IP44 PS	4099854042157	3000	44	03	120°	> 80	-20...+45	> 0.9	1.2 kg
SF CIRC 500 SEN V 42W 840 IP44 PS	4099854042171	4000	44	03	120°	> 80	-20...+45	> 0.9	1.2 kg
SF CIRC 500 V 42W 830 IP44 DALI	4099854077890	3000	44	03	120°	> 80	-20...+45	> 0.9	1.3 kg
SF CIRC 500 V 42W 840 IP44 DALI	4099854077913	4000	44	03	120°	> 80	-20...+45	> 0.9	1.3 kg

**

SF CIRC 500 V 42W IP44 PS	W _{AC}	42 W	30 W	19 W
SF CIRC 500 SEN V 42W IP44 PS	lm	3500 lm	2500 lm	1500 lm

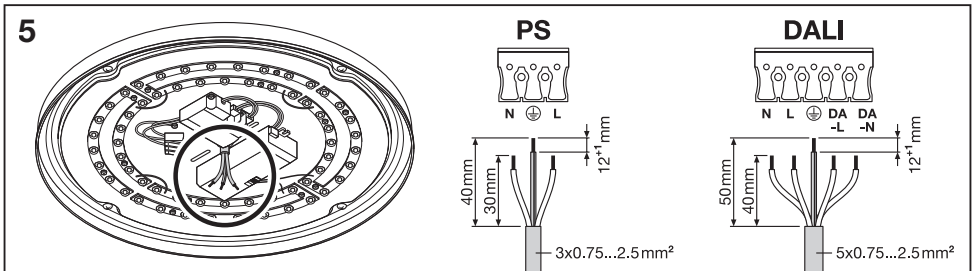
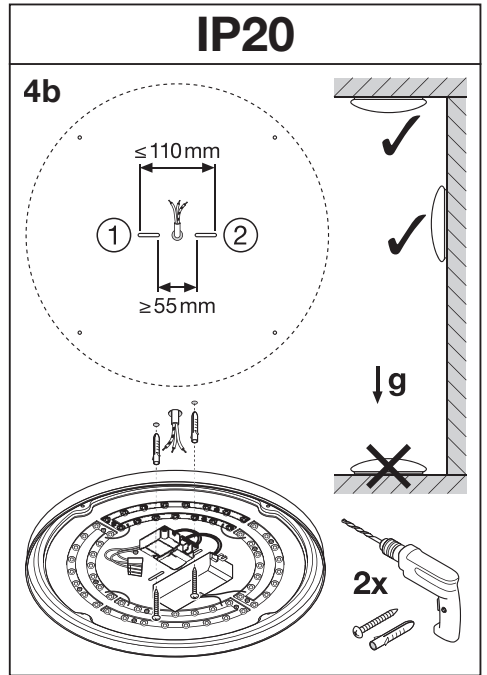
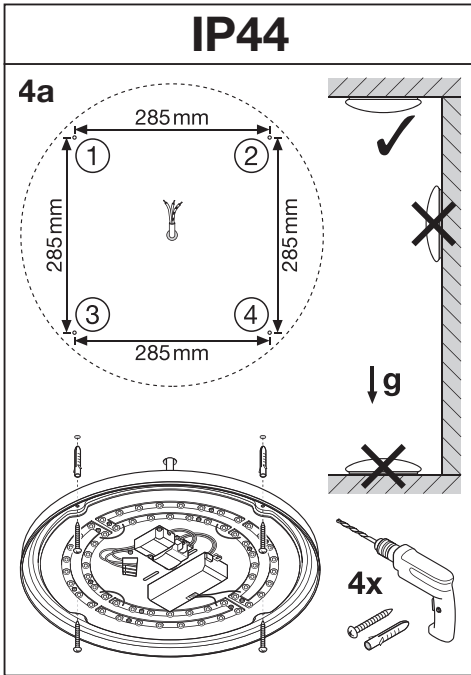
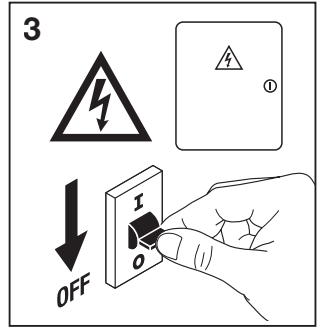
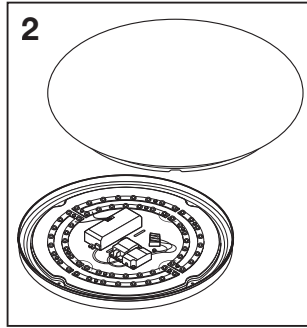
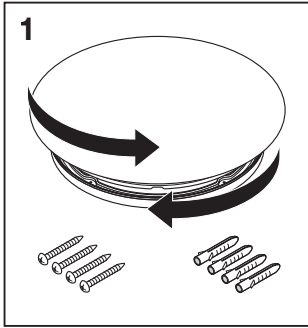

6 SURFACE CIRCULAR 500 PS SURFACE CIRCULAR 500 SENSOR PS

**

PS-Power Select

WAC	42	30	19
Im	3500	2500	1500

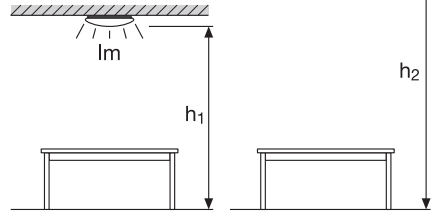
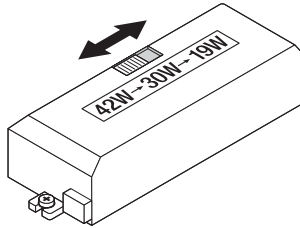

7 SURFACE CIRCULAR 500 SENSOR PS

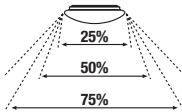
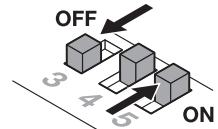
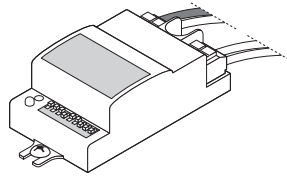
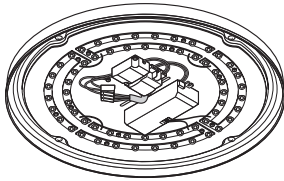

Detection Area

1	2	3	
ON	ON	ON	100 %
-	ON	ON	75 %
ON	-	ON	50 %
-	-	ON	25 %
-	-	-	10 %



Hold Time

4	5	6	
ON	ON	ON	5 s
-	ON	ON	30 s
ON	-	ON	90 s
-	-	ON	3 min
ON	ON	-	20 min
-	-	-	30 min



Daylight Sensor

7	8	9	
ON	ON	ON	2LUX
ON	ON	-	10LUX
-	ON	-	25LUX
ON	-	-	50LUX
-	-	-	Disable

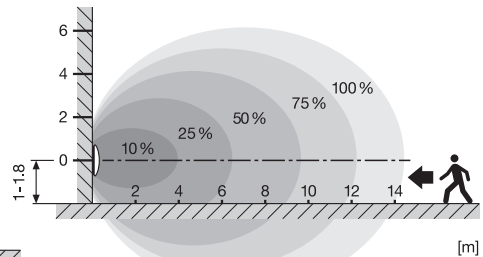
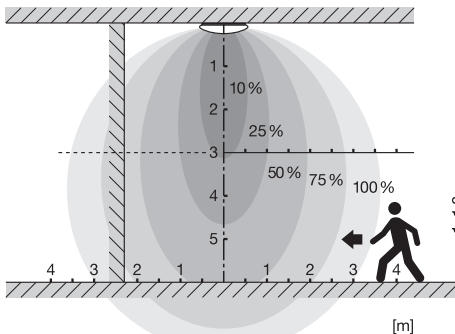

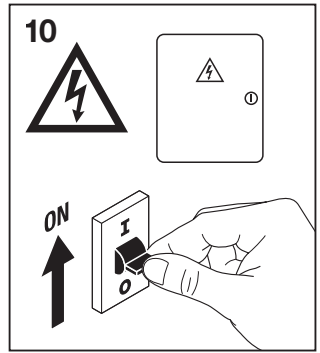
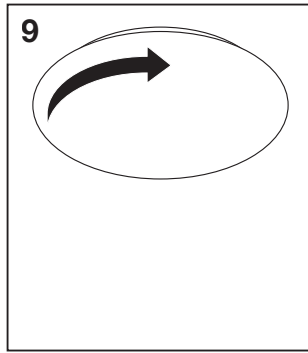
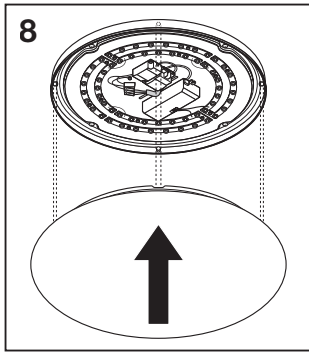

		lout (mA) 1000	C10 A 	B16 A 	C16 A 	DALI DIM
SF CIRC 500 V	-		10x	11x	17x	
SF CIRC 500 SEN V	-		7x	7x	11x	
SF CIRC 500 V DALI	Tridonic LCA 45W 500-1400mA one4all SC PRE		26x	25x	43x	

SF CIRCULAR 500 COVER	SF CIRCULAR 500 FRAME	EAN	Ø x h [mm]
		4099854064395	500 x 99
		4058075834187	560 x 105
		4058075834200	560 x 105

* ① Leuchten mit zusätzlichen Notstrom-Anforderungen gemäß EN 60598-2-22 zertifiziert (gilt nicht für Frankreich und Dänemark). ② Luminaires certified including the additional emergency requirements of EN 60598-2-22 (not applicable for France and Denmark). ③ Luminaires homologués conformément aux exigences supplémentaires de la norme EN 60598-2-22 en matière d'éclairage de secours (ne s'applique pas pour la France et le Danemark). ④ Impianti di illuminazione certificati includendo i requisiti aggiuntivi di emergenza di EN 60598-2-22 (non applicabili a Francia e Danimarca). ⑤ Lámparas certificadas incluyendo los requisitos de emergencia adicionales de EN 60598-2-22 (no aplicable para Francia y Dinamarca). ⑥ Luminárias certificadas, incluindo os requisitos de emergência adicionais da norma EN 60598-2-22 (não se aplica para França e Dinamarca). ⑦ Φωτιστικά σώματα πιστοποιημένα περιλαμβάνοντων των πρόσθετων απαιτήσεων έκτακτης ανάγκης του EN 60598-2-22 (δεν έχει εφαρμογή για Γαλλία και Δανία). ⑧ Geceerficeerde lampen die voldoen aan de bijzondere eisen van NBN-EN-IEC 60598-2-22 verlichtingsarmaturen voor noodverlichting (geldt niet voor Frankrijk en Denemarken). ⑨ Ljusarmaturerna är certifierade inklusive Nödbelysningskraven i EN 60598-2-22 (ej tillämpligt för Frankrike och Danmark). ⑩ Valaisimet on sertifioitu EN 60598-2-22 -normin turvalaisimia koskevien lisävaatimusten mukaan (ei koske Ranskaa ja Tanskaa). ⑪ Armaturer sertifisert inkludert tilleggskrav til nødsituasjoner i henhold til EN 60598-2-22 (gjelder ikke Frankrike og Danmark). ⑫ Armaturer certificeret med ekstra nødsvak iht. EN 60598-2-22 (gælder ikke for Frankrig og Danmark). ⑬ Světidla certifikovaná s dodatečnými požadavky na nouzový proud podle normy EN 60598-2-22 (neplatí pro Francii a Dánsko). ⑭ Светильники сертифицированы с учетом дополнительных аварийных требований стандарта EN 60598-2-22 (не применимо для Франции и Дании). ⑮ A lámpatestek az EN 60598-2-22 szabvány kiegészítő védelmi előírásait is figyelembe véve tanúsítottak (Franciaország és Dánia esetén nem érvényes). ⑯ Dopravu osvětleníové z certifikatem potvrzujícím splnění dodatkových vyžadavků dotýčících osvětlení awarijného zgodnie z normą EN 60598-2-22 (nie dotyczy Francji i Danii). ⑰ Certificované světledla vrátane dodatčných núdzových požiadaviek normy EN 60598-2-22 (neplatí pre Francúzsko a Dánsko). ⑱ Svetilke z dodatnimi zahtevami glede napajanja v sili, certificirane v skladu z EN 60598-2-22 (ne velja za Francijo in Dansko). ⑲ EN 60598-2-22 sayılı standardın ek acil gerekliliklerini içeren sertifikalı armatürler (Fransa ve Danimarka için geçerli değildir). ⑳ Certificirana rasvjetna tijela uključujući dodatne zahtjeve u slučaju opasnosti sukladno normi EN 60598-2-22 (nije primjenjivo za Francusku i Dansku). ㉑ Corpi de iluminat certificate inclusiv pentru cerințele suplimentare de urgență din EN 60598-2-22 (neaplicabile pentru Franța și Danemarca). ㉒ Осветителни тела, сертифицирани включително съгласно допълнителните изисквания за аварийно осветление по EN 60598-2-22 (не се отнася за Франция и Дания). ㉓ Valgustid, mis on sertifitseeritud muuhulgas vastavalt standardiga EN 60598-2-22 kehtestatud hädaolukustuse erinõuete osas (ei kehti Prantsusmaal ja Taanis korral). ㉔ Sviestlvaal sertifikuoti, įskaitant papildomus išskirtinius reikalavimus pagal EN 60598-2-22 (netaikoma Prancūzijoje ir Danijoje). ㉕ Gaismekit serifficéit, tostarp iekšējai EN 60598-2-22 papildu ārkārtas prasības (neattiecas uz Franciju un Dāniju). ㉖ Sertifikovane svetilke, uključujući i dodatne zahtjeve za hitne slucajeve u skladu sa EN 60598-2-22 (ne važi za Francusku i Dansku). ㉗ Светильники сертифицирани з урахуванням додаткових вимог щодо світильників для аварійного освітлення згідно зі стандартом EN 60598-2-22 (не діє для Франції та Данії). ㉘ Бұл шамдалдар EN 60598-2-22 стандартының қосымша тегінен талаптарына сай сертификатталған (Франция мен Дания үшін қолданылмайды).

LEDVANCE GmbH
Steiner Furt 62
86167 Augsburg, Germany
www.ledvance.com

FR
Cet appareil et ses accessoires se recyclent

À DÉPOSER EN MAGASIN

OU

À DÉPOSER EN DÉCHÈTERIE

C10449057
G11174057
13.07.23

⑥ LEDVANCE Ltd, Aquila House
Delta Crescent, Westbrook, Warrington
WA5 7NR, United Kingdom