

	29 V ~
	12mA
KNX BUS	
	4 x (Ø 0,6 < < Ø 0,8) 8 mm
	<p>Radio fréquence 2400-2483.5 MHz (16 canaux) – Débit : 250 KO/s Puissance Sortie Radio < 10dBm / 10mW Réseau sans fil maillé, auto-adaptatif et sécurisé (AES 128), selon la norme IEEE 802.15.4 (LR-WPAN)</p> <p>Radiofrequentie 2400-2483.5 MHz (16 kanalen) – Doorvoer: 250 kB/s Radio-uitgangsvermogen < 10 dBm / 10 mW Draadloos vermaasd netwerk, zelfaanpassend en met hoogstaande beveiliging (AES 128), volgens de norm IEEE 802.15.4 (LR-WPAN)</p> <p>2400-2483.5 MHz Radiofrequency band (16 channels) - Byte rate: 250 KB/s RF Power Output < 10 dBm / 10 mW Self healing MESH network with high security level (AES128) according to HA1.2 of IEEE 802.15.4 (LR-WPAN) standard</p> <p>Funkfrequentz 2400-2483.5 MHz (16 Kanäle) - Übertragungsrate: 250 KB/s Funkleistungsangang < 10 dBm / 10 mW Drahtloses Mesh-Netzwerk, selbstanpassend und sicher (AES 128), gemäß der Norm IEEE 802.15.4 (LR-WPAN)</p> <p>Frecuencia de radio de 2400-2483.5 MHz (16 canales) – Velocidad: 250 KB/s Potencia de salida de radio < 10 dBm/10 mW Red inalámbrica de malla, adaptativa y protegida (AES 128) según la norma IEEE 802.15.4 (LR-WPAN)</p> <p>Frequência de rádio 2400-2483.5 MHz (16 canais) – banda: 250 KO/s Potência de saída de RF < 10 dBm / 10 mW Rede sem fios de malha, auto adaptativa e segura (AES 128), segundo a norma IEEE 802.15.4 (LR-WPAN)</p> <p>Радиочастота 2400-2483.5 МГц (16 каналов) – Проř: 250 kB/s Iσγός εξόδοο ραδιοισονοτήτων < 10 dBm / 10 mW Ασύρματο πλεγματοκό δίκτυο, αυτοπροσαρμοζόμενο και ασφαές (AES 128), σύμφωνα με το πρότυπο IEEE 802.15.4 (LR-WPAN)</p> <p>Радиочастота 2400-2483.5 МГц (16 каналов) – Скорость: 250 КБ/с Выходная мощность РЧ < 10 dBm / 10 mW Саморегулирующаяся беспроводная ячеистая сеть с высоким уровнем защиты (AES 128) согласно стандарту IEEE 802.15.4 (LR-WPAN)</p> <p>2400-2483.5 MHz radyo frekans (16 kanal) – Akış: 250 kB/s RF Güç Çıkışı < 10 dBm / 10 mW Kablosuz mesh tipi ađ, otomatik uyarlamalı ve güvenliklili (AES 128), IEEE 802.15.4 (LR-WPAN) normuna uygun</p>
	150 m
	+5°C à +45°C / +5°C tot +45°C / +5°C to +45°C / +5°C bis +45°C / +5°C a +45°C / +5°C a +45°C / +5°C έως +45°C / от +5°C до +45°C / +5°C - +45°C
	95 % max.
Canal/Kanaal/ Channel/Kanal/ Canal/Canal/ Διαυλος/Канал/ Kanal	Tout dans la bande 2,4 GHz (11-26) :11 / In de gehele band 2,4 GHz (11-26) :11 / All in 2.4 GHz band (11-26) :11 / Alles im 2,4 GHz Band (11-26) :11 / Todo en la banda 2,4 GHz (11-26) :11 / Tudo na banda 2,4 GHz (11-26) :11 / Όλα στη ζώνη 2,4 GHz (11-26) :11 / Все вполосе 2,4 ГГц (11-26) :11 / Tümü 2,4 GHz bandında (11-26) :11

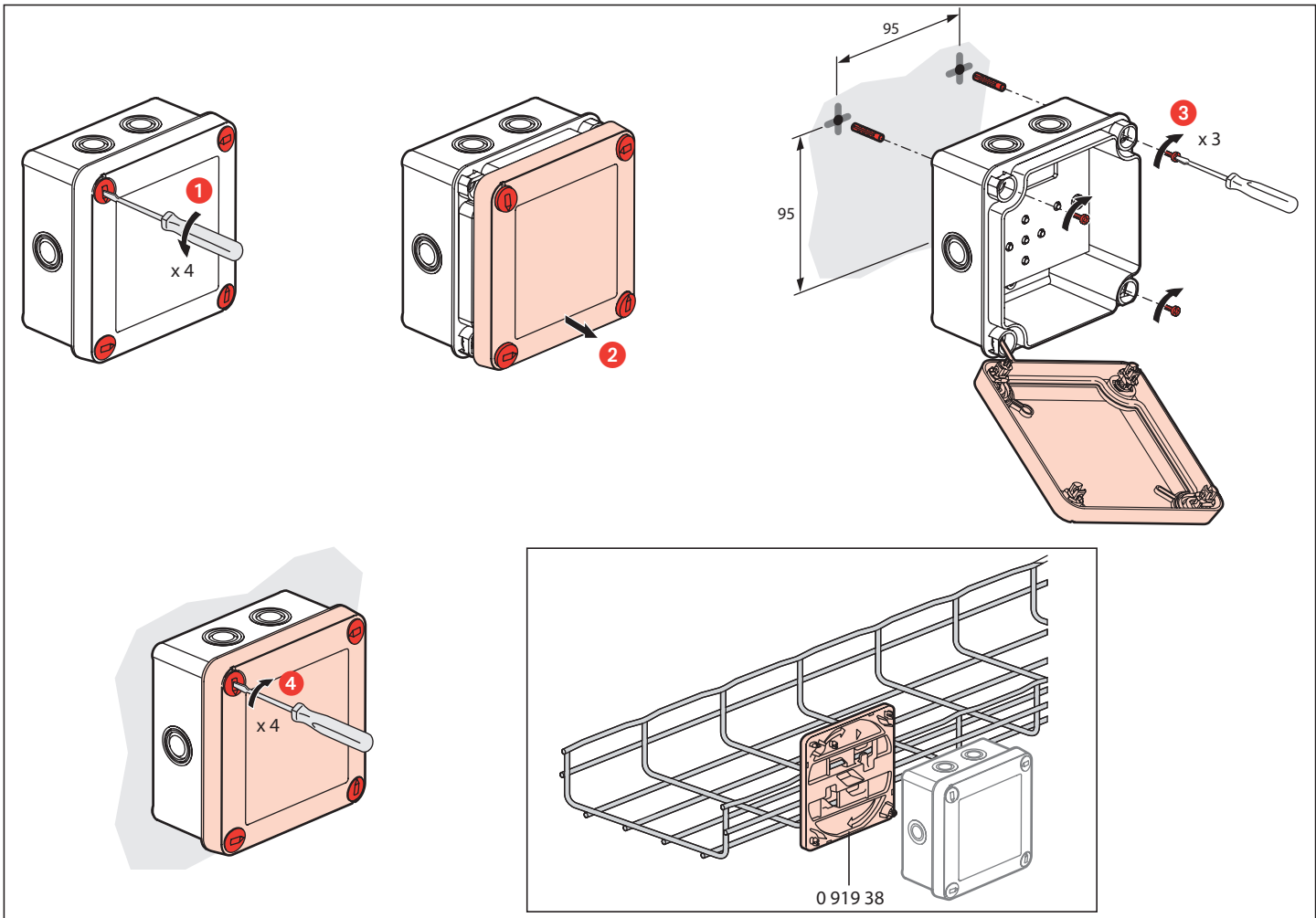

Led de programmation Connecteur KNX
Programmeerled Connector KNX
 KNX connector Programming LED
Programmier-LED KNX Steckverbinder
 LED de programación Conector KNX

Led de programação Conector KNX
 LED προγραμματισμού Συνδετήρα KNX
 Светодиод программирования соединительного
 устройства KNX
 KNX soketi programlama ledi

Bouton de programmation Connecteur KNX
Programmeerknop Connector KNX
 KNX connector Programming button
Programmiertaste KNX Steckverbinder
 Botón de programación Conector KNX
Botão de programação Conector KNX
 Κουμπιέ προγραμματισμού Συνδετήρα KNX
 Кнопка программирования соединительного
 устройства KNX
 KNX soketi programlama butonu

Pavé de programmation radio
Programmeeroppervlak radio
 Radio programming keypad
Funk-Programmiertastatur
 Panel de programación radio
Panel de programação de rádio
 Πληκτρολόγιο ραδιοφωνικού
 προγραμματισμού
*Панель программирования
 радиоуправления*
 Radyo programlama paneli

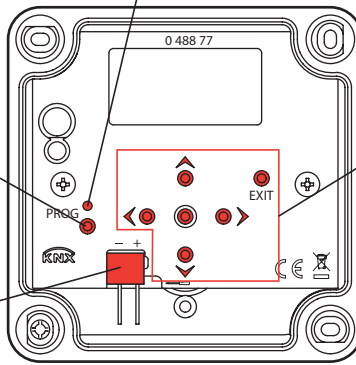

Navigation sélection
Navigeren in selecties
 Selection navigation
Auswahlnavigation
 Navegación selección

Navegação seleção
 Πλοήγηση επιλογής
 Выбор позиции
 Seçim değişikliği

Validation
Bevestigen
 Validation
Bestätigung
 Validación

Validação
 Επικύρωση
 Подтверждение
 Onay

Navigation valeur
Navigeren in waarden
 Value navigation
Wertnavigation
 Navegación valor

Navegação valor
 Πλοήγηση τιμής
 Выбор значения
 Değer değişikliği

Retour au menu principal
Terug naar hoofdmenu
 Back to main menu
Zurück zum Hauptmenü
 Volver al menú principal

Voltar ao menu principal
 Επιστροφή στο κύριο μενού
 Возврат к главному меню
 Ana menüye dönüş

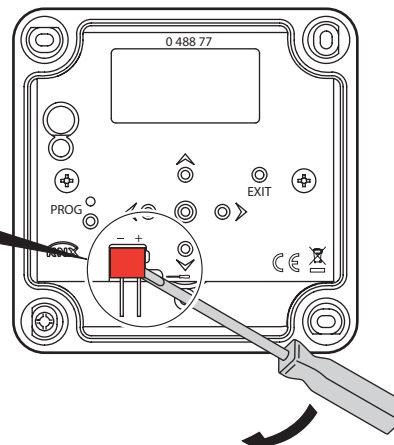
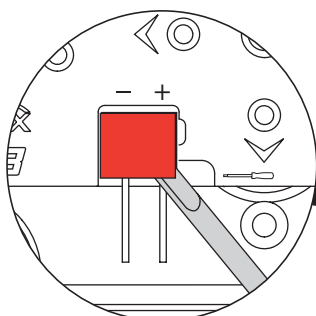
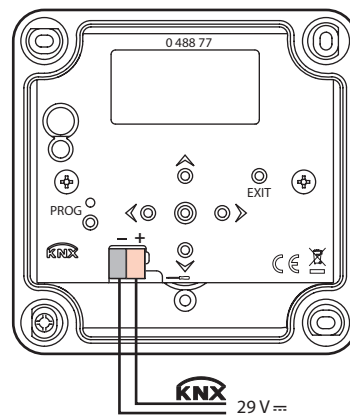

		OFF/ОТКЛ	
		ALLUME ON STEADY ВКЛ	
		CLIGNOTEMENT LENT SLOW FLASHING МИГАНИЕ С НИЗКОЙ ЧАСТОТой	 1s/1s 1s/1s 1s/1s <p>Clignotement constant. Une fois par seconde. Constant flash. Once a second. Непрерывное мигание. Один раз в секунду</p>

Installation d'un émetteur/Installing a transmitter

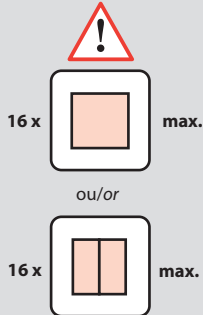

A configurer un par un
To configure one by one

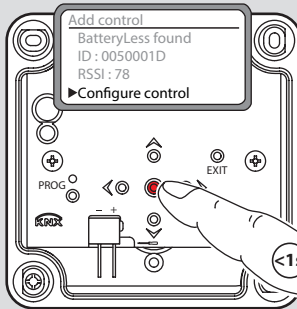
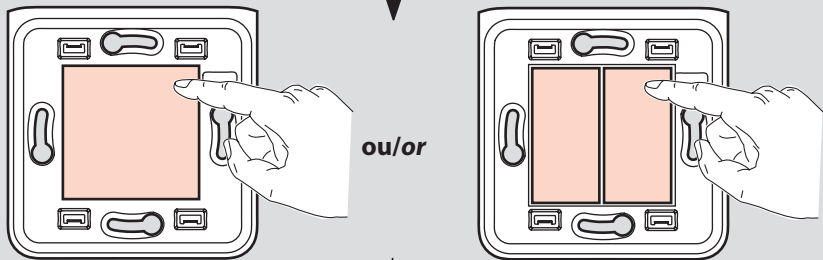
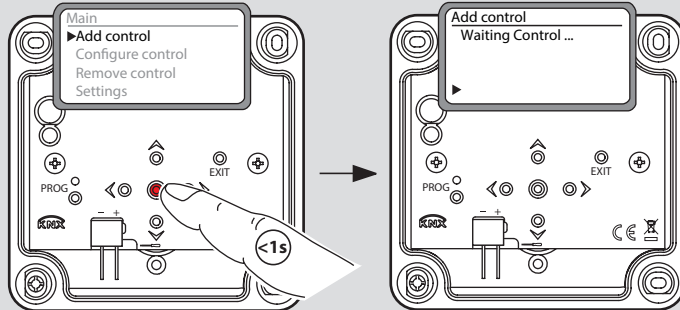

1..... → 16
ou non utilisé
or not used

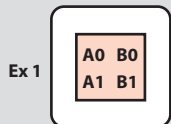

Ex 1 Association des voies KNX avec les boutons
Binding KNX channels to buttons

A0 = B0
A1 = B1

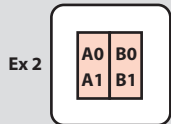

Ex 2 A0 ≠ B0 ≠ A1 ≠ B1

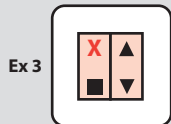

Ex 3 A0 = not used
B0 ≠ A1 ≠ B1

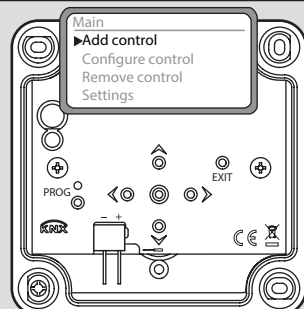
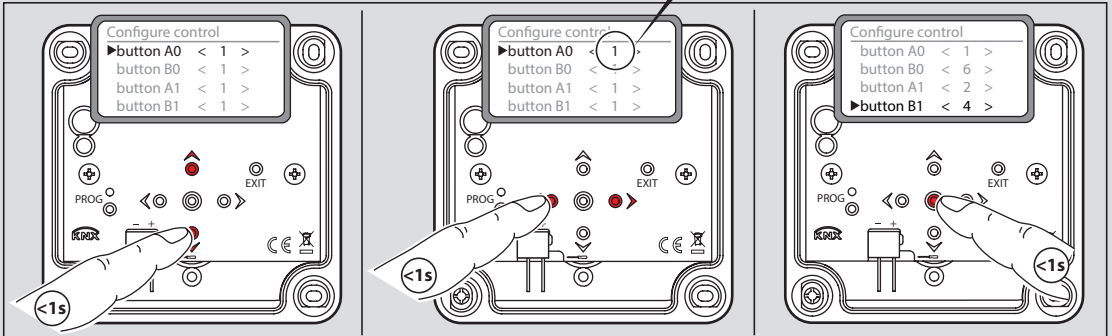

Répéter l'opération pour chaque émetteur
Repeat this step for each transmitter

Configuration d'un émetteur/Configuring a transmitter

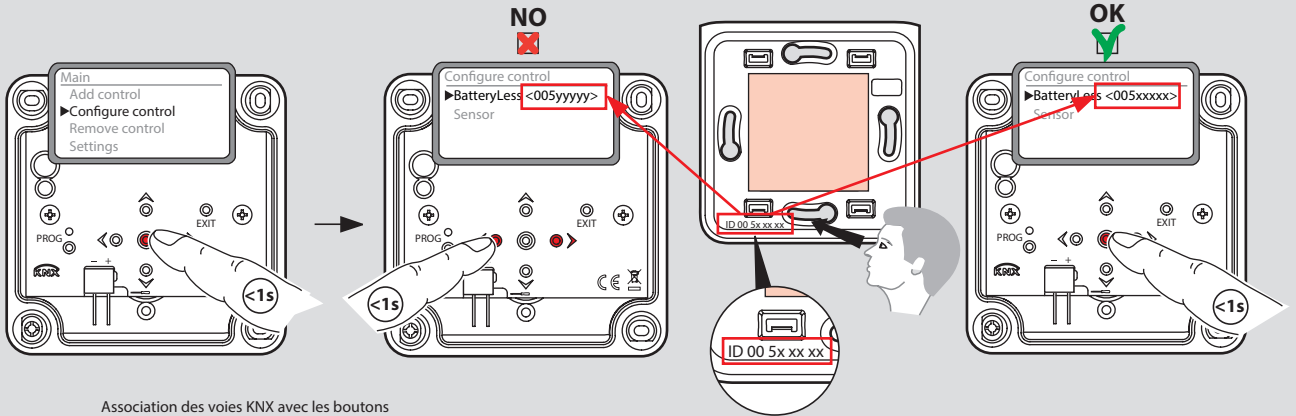

Association des voies KNX avec les boutons
Binding KNX channels to buttons

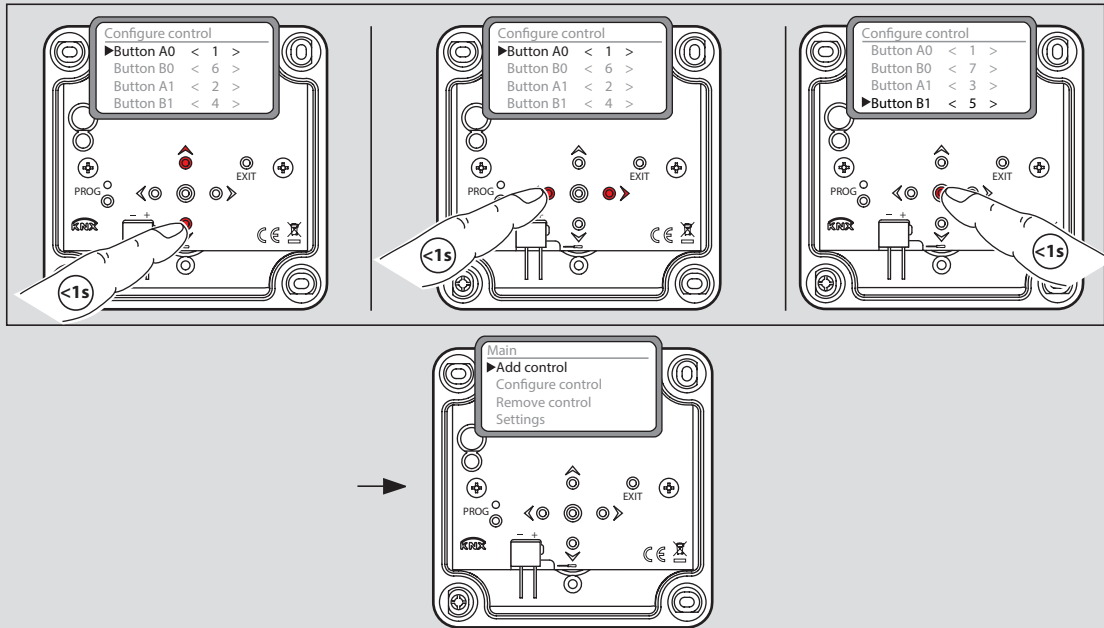

Suppression d'un émetteur/Deleting a transmitter

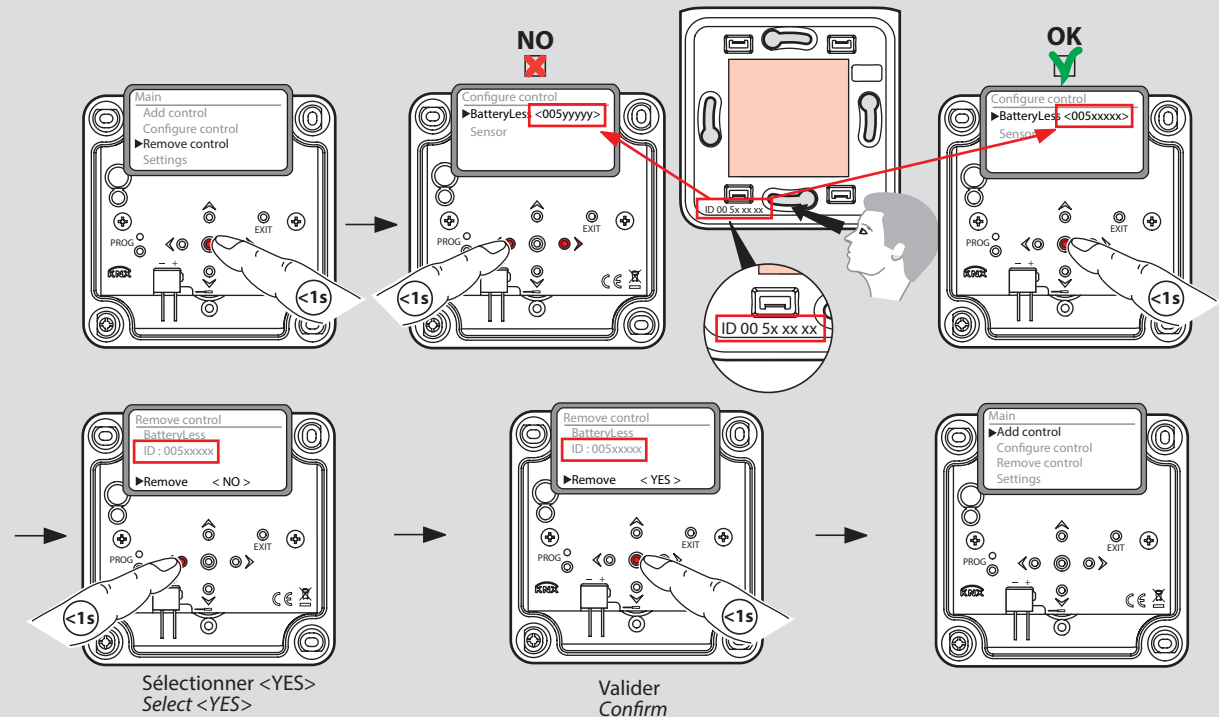

Installation d'un détecteur/Installing a detector

4 x max.
A configurer un par un
To configure one by one

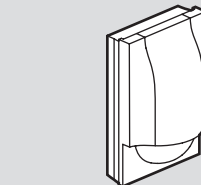
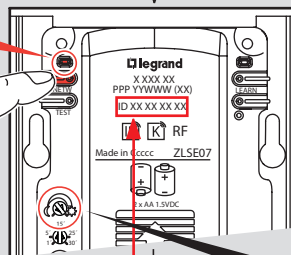
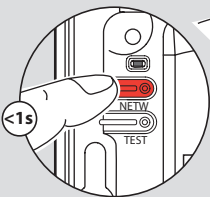
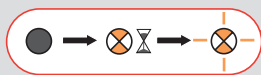
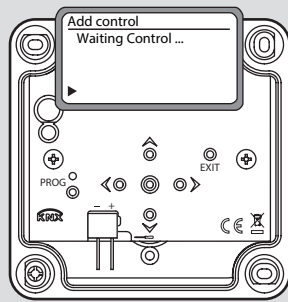
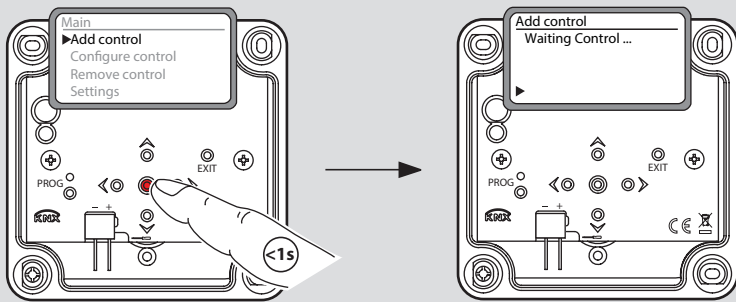

Ne tient pas compte de l'intensité lumineuse, donc :
Lighting intensity ignored, also:

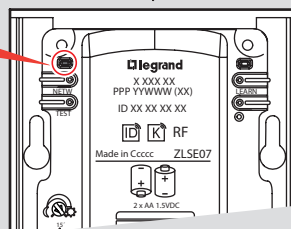
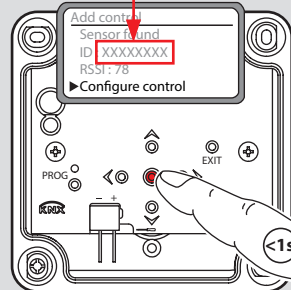
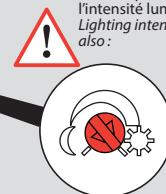

Association de la voie KNX avec le détecteur
Binding the KNX channel to the detector

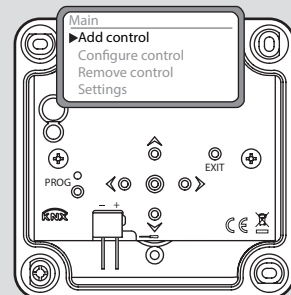
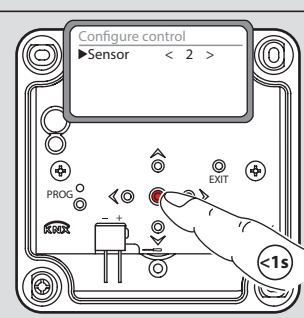
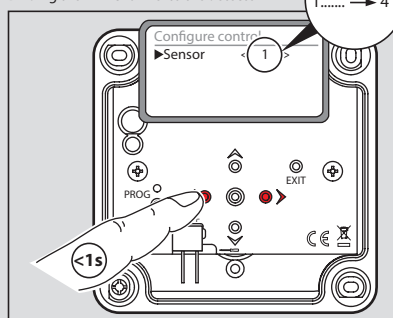

Répéter l'opération pour chaque détecteur
Repeat this step for each transmitter

Configuration d'un détecteur/Configuring a detector

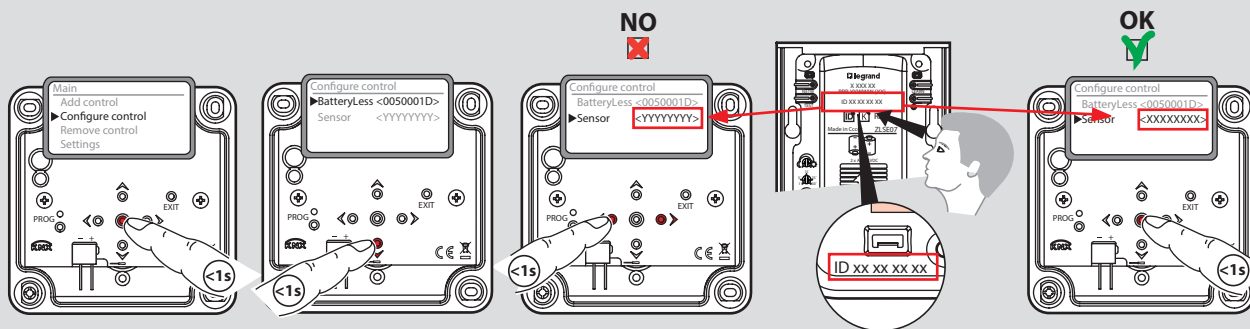

Association de la voie KNX avec le détecteur
Binding the KNX channel to the detector

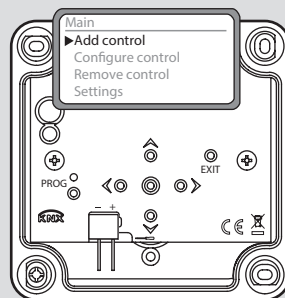
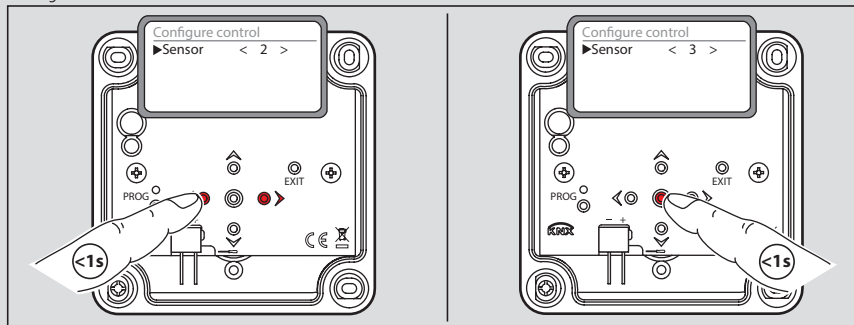

Suppression d'un détecteur/Deleting a detector

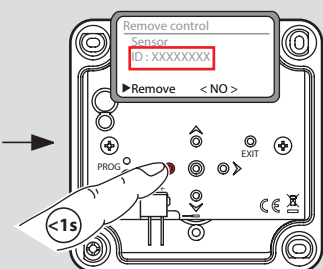
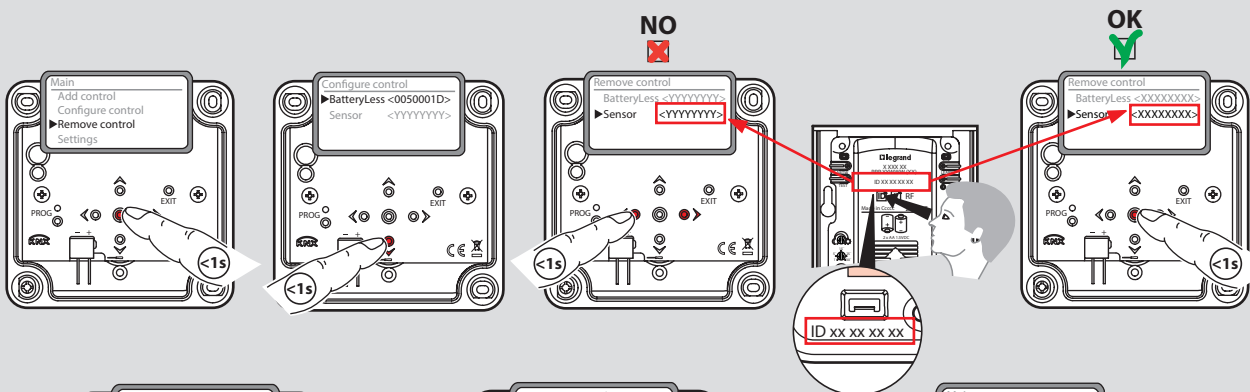

Choisir <YES>
Select <YES>

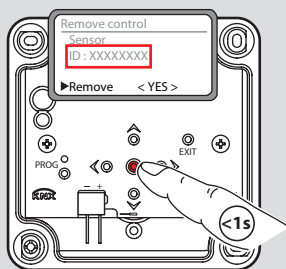

Valider
Confirm

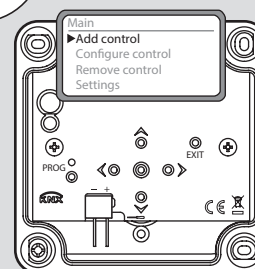

Diagnostique radio/Radio Diagnostic

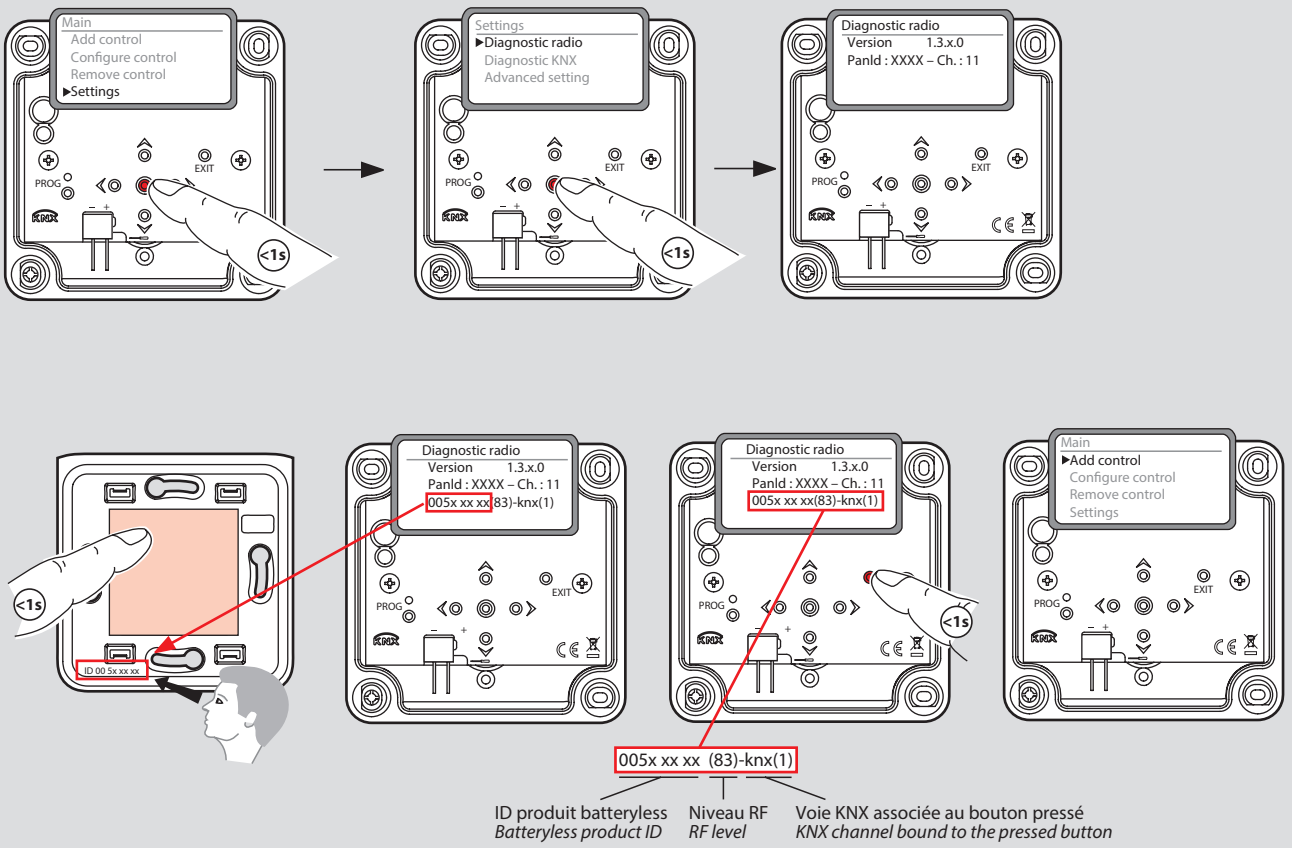

Diagnostique KNX/KNX Diagnostic

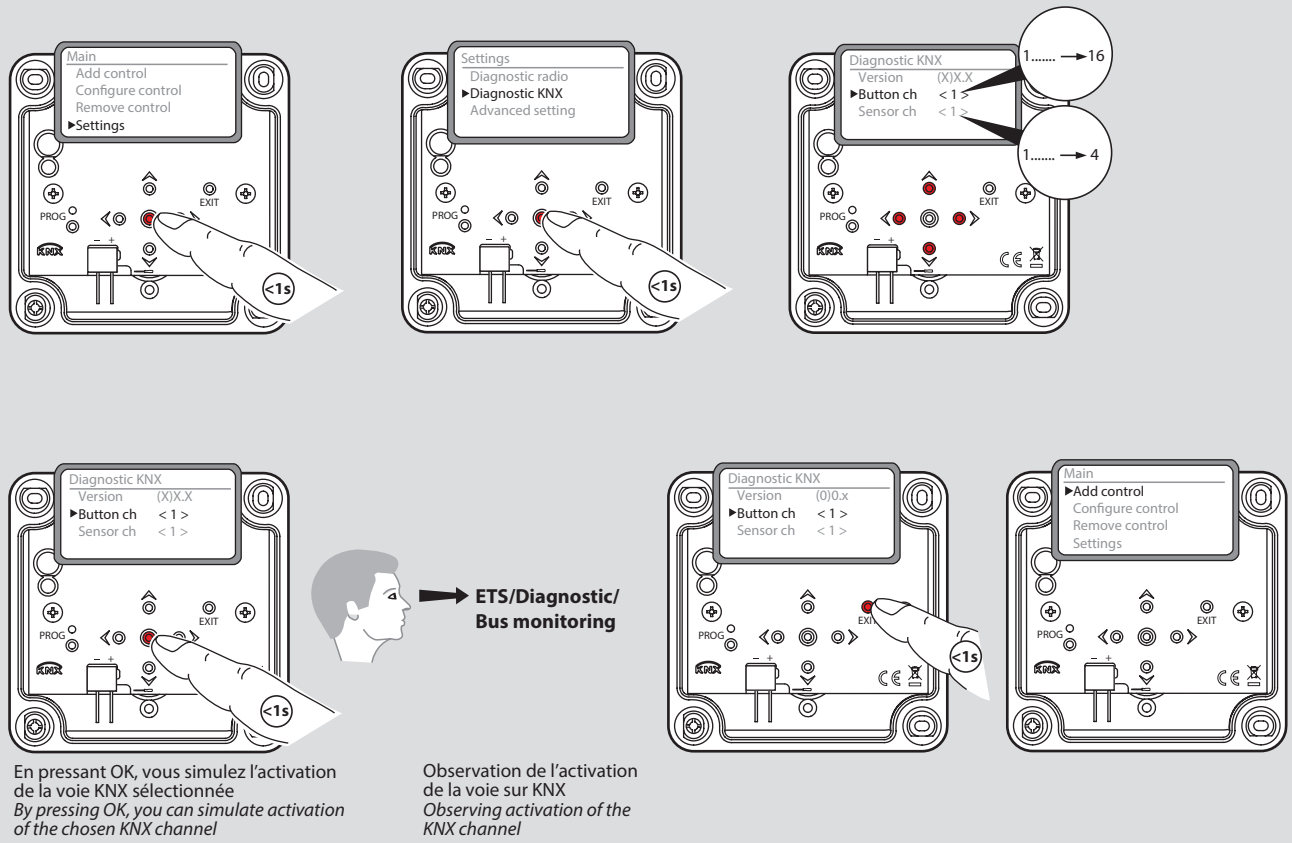

**Formation du réseau sur le meilleur canal radio/
Creating the network on the best radio channel**

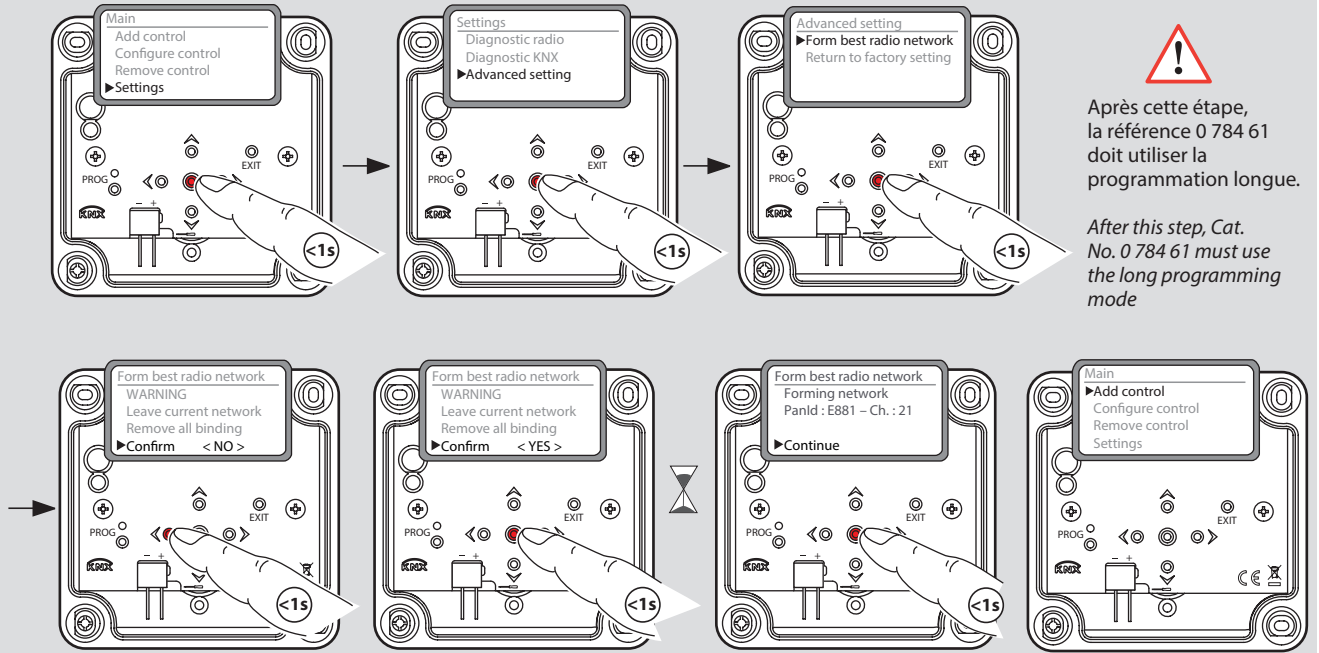

**Remise en configuration d'usine/
Factory reset**

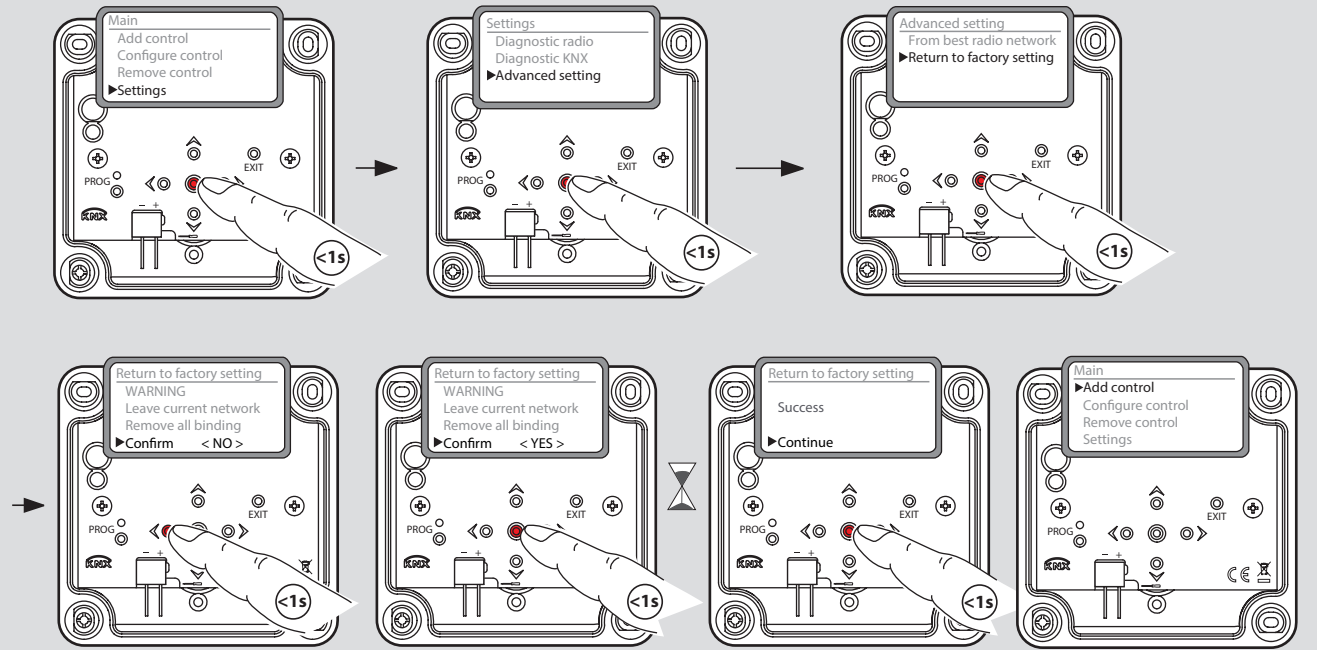

⚠️ **Consignes de sécurité** (FR LU BE CH)
Avant toute intervention, couper le courant.
Respecter strictement les conditions d'installation et d'utilisation.

⚠️ **Veiligheidsvoorschriften** (NL BE)
Onderbreek voor enige ingreep de stroom.
Neem de installatie- en gebruiksvoorwaarden nauwgezet in acht.

⚠️ **Safety instructions** (GB IE)
Make sure the power supply is disconnected before any intervention.
Strictly comply with instructions for installation and use.

⚠️ **Sicherheitshinweise** (DE CH)
Vor jeglichem Eingriff die Spannungsfreiheit sicherstellen.
Einbau- und Gebrauchsanleitungen sind genau zu beachten.

⚠️ **Consignas de seguridad** (ES)
Antes de realizar cualquier intervención, cortar la corriente eléctrica.
Respetar estrictamente las condiciones de instalación y uso.

⚠️ **Instruções de segurança** (PT)
Antes de qualquer intervenção, desligar a corrente.
Respeitar rigorosamente as condições de instalação e de utilização.

⚠️ **Συστάσεις ασφαλείας** (GR CY)
Πριν από οποιαδήποτε επέμβαση, διακόψτε την παροχή ρεύματος.
Να τηρείτε αναστράτις συνθήκες εγκατάστασης και χρήσης.

⚠️ **Меры предосторожности** (RU)
Отключить питание перед проведением любых ремонтных работ.
Строго соблюдайте требования к условиям монтажа и эксплуатации.

⚠️ **Güvenlik talimatları** (TR CY)
Herhangi bir müdahaleden önce, akımı kesiniz.
Yerleşirme ve kullanım koşullarına titizlikle riayet ediniz.

Le soussigné, LEGRAND, déclare que l'équipement radioélectrique du type (0 488 77) est conforme à la directive 2014/53/UE.
Le texte complet de la déclaration UE de conformité est disponible à l'adresse suivante : www.legrandoc.com

De ondergetekende, LEGRAND, verklaart dat de radioapparatuur van het type (0 488 77) voldoet aan de richtlijnen van 2014/53/EU.
De volledige tekst van de EU-conformiteitsverklaring is beschikbaar op: www.legrandoc.com

The undersigned, LEGRAND, declares that radio equipment of the type (0 488 77) complies with Directive 2014/53 / EU.
The full text of the EU declaration of conformity can be found at: www.legrandoc.com

Legrand bestätigt hiermit, dass unser Funksignal-Gerät der Type (0 488 77) die Richtlinie 2014/53/EU erfüllt.
Die komplette Konformitätserklärung finden sie unter: www.legrandoc.com

El abajo firmante, LEGRAND, declara que el equipo radioeléctrico de tipo (0 488 77) cumple con la directiva 2014/53/UE.
El informe completo de la declaración UE de conformidad se encuentra disponible en: www.legrandoc.com

O abaixo assinado, LEGRAND, declara que o equipamento radioelétrico de tipo (0 488 77) cumpre com a diretiva 2014/53/EU.
O texto completo da declaração EU de conformidade encontra-se disponível no seguinte endereço : www.legrandoc.com

Ο κάτωθι υπογεγραμμένος, LEGRAND, δηλώνει ότι τα υλικά ασύρματης τεχνολογίας του τύπου (0 488 77) είναι σύμφωνα με την Οδηγία 2014/53 / EU. Το πλήρες κείμενο της δήλωσης συμμόρφωσης της ΕΕ είναι διαθέσιμο στην ηλεκτρονική διεύθυνση: www.legrandoc.com

Компания LEGRAND заявляет, что типовое радиоэлектронное оборудование (0 488 77) соответствует требованиям Директивы 2014/53/UE.
Полный текст декларации о соответствии ЕС доступен на сайте: www.legrandoc.com

Aşağıda imzası bulunan LEGRAND, (0 488 77) telsiz ekipmanın 2014/53/AB sayılı Direktife uygun olduğunu beyan eder.
AB uyumu beyanının tam metni www.legrandoc.com adresinde bulunabilir.