

PAK 50 M6 EX KB ER (306 205)

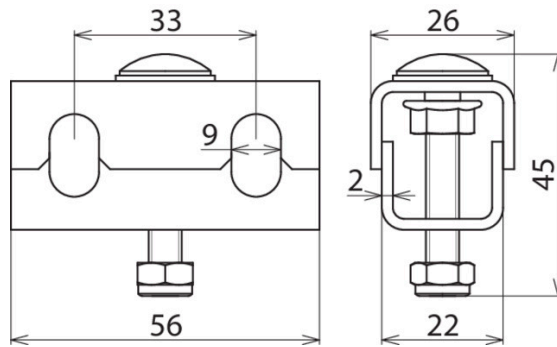

Figure without obligation



Equipotential bonding clamp for cable trays

- Connection only with ring equipotential bonding conductor 50 mm², Part No. 832 839 (tinned copper cable)
- For mounting on the perforated cable tray or on the EB plate (PAP 1 / PAP 2)
- EB clamp to be mounted approx. every 0.5 m

Type	PAK 50 M6 EX KB ER
Part No.	306 205
Material	StSt
Connection to	PAP 1 EX KB ER or PAP 2 EX KB ER or cable tray or wide span cable tray
Clamping range EB ring conductor	50 mm ² , Cu/gal Sn
Screw	M6 x 35 mm
Material of screw / nut	StSt
Material No.	1.4301
EX zone	2/22
Weight	73 g
Customs tariff number	85389099
GTIN	4013364336773
PU	50 Stk

We reserve the right to introduce changes in performance, configuration and technology, dimensions, weights and materials in the course of technical progress. The figures are shown without obligation.