

**RECESS CEILING
SPOT**

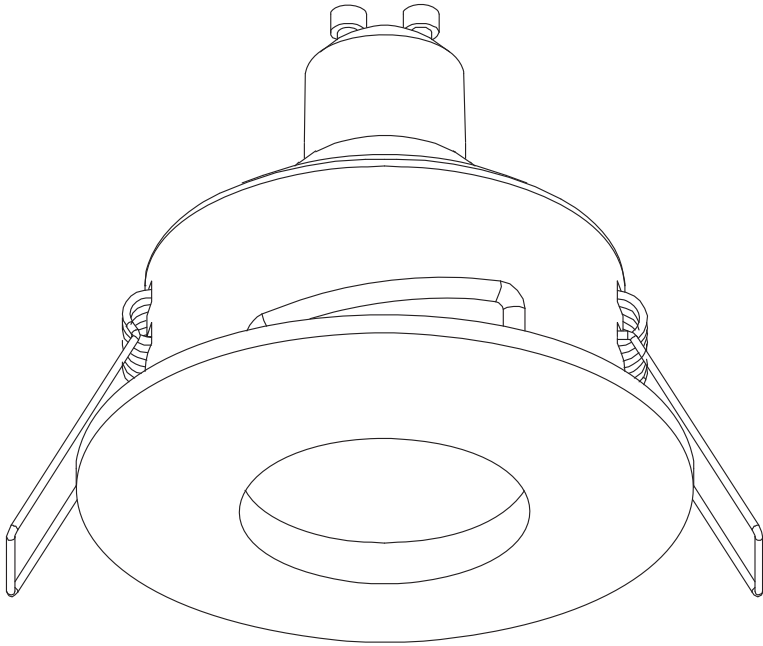

	EAN	W	Max. W	lm	K	IP	⊖ (°C)	V-	mA	Hz	PF
SP SET 4.3W 2700K 230V IP65 WT GU10	4058075573031	4.3	100	280	2700	65	-20...+40	220- 240	38	50/60	>0.4

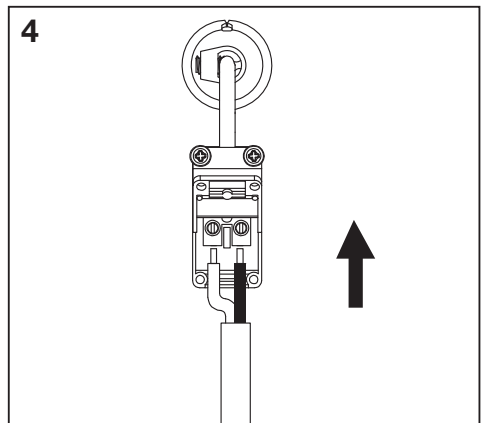
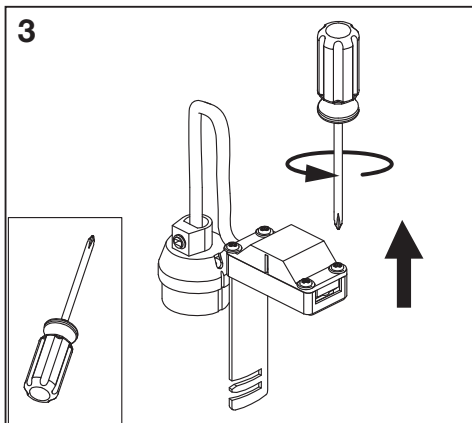
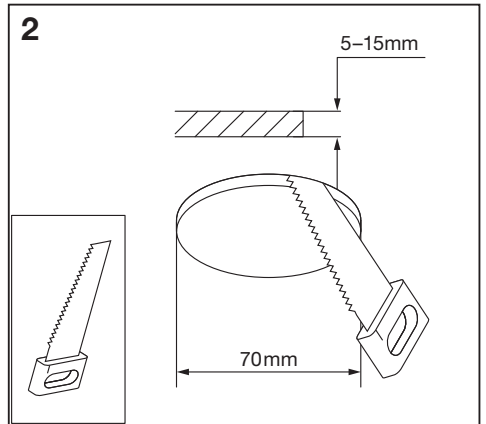
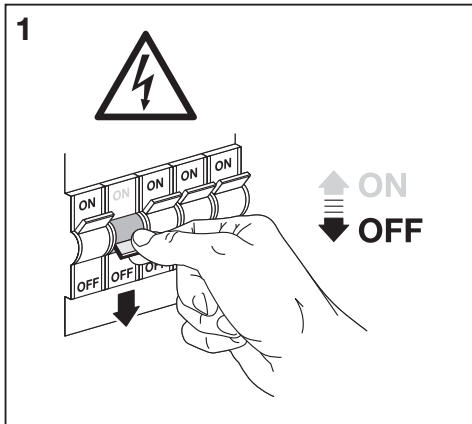
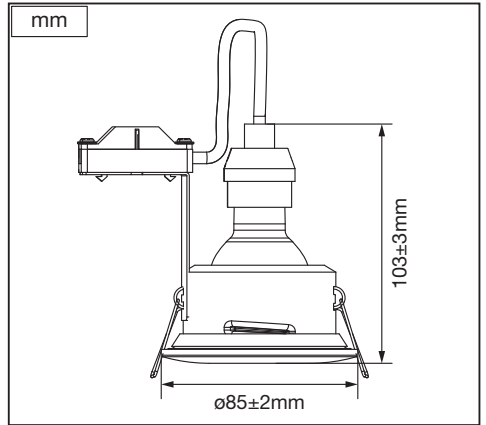
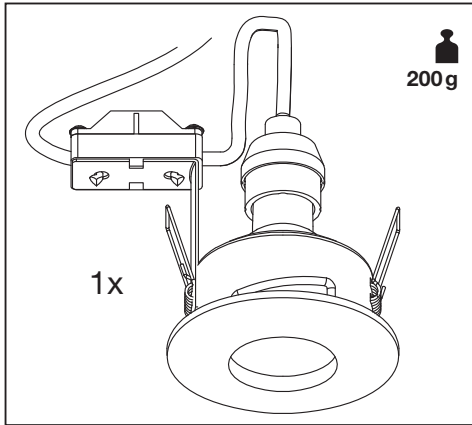

	EAN	This product contains a light source of energy efficiency class	Contained Light Source
SP SET 4.3W 2700K 230V IP65 WT GU10	4058075573031	F	



C10449057
G11117428
26.01.2022



LEDVANCE GmbH
Steinerne Furt 62
86167 Augsburg, Germany
www.ledvance.com