



EcoStruxure Control Expert and Companion softwares



EcoStruxure Control Engineering



EcoStruxure OPC UA Server and OPC Factory Server

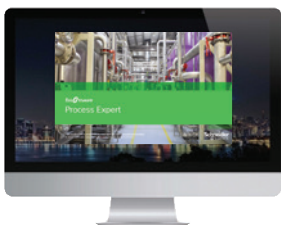

EcoStruxure Process Expert

Modicon PAC Engineering and Operation Software

Eco  truxure™



Modicon

Discover Modicon

Industrial Edge control for IIoT

Modicon IIoT-native edge controllers manage complex interfaces across assets and devices or directly into the cloud, with embedded safety and cybersecurity. Modicon provides performance and scalability for a wide range of industrial applications up to high-performance multi-axis machines and high-available redundant processes.

Explore our offer

- Modicon HVAC Controllers
- Modicon PLC
- Modicon Motion Controllers
- Modicon PAC
- Modicon I/O
- Modicon Networking
- Modicon Power Supply
- Modicon Safety
- Modicon Wiring

Life Is On

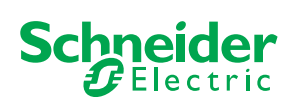

Quick access to product information

Get technical information about your product

References

Modicon TM3
I/O expansion modules for Modicon controllers
Analog I/O modules

Number and type of channels	Input range	Output range	Resolution	Input terminal (Modicon TM3)	Reference	Weight
2 enhancement inputs	-10...+10VDC 0...20mA, 4...20mA	0...12VDC 0...12VDC	10 bits or 10 bits or 12 bits	Terminal 2 Terminal 3	TM3AI2H TM3AI2H	0,110 0,230
4 enhancement inputs	-10...+10VDC 0...20mA, 4...20mA	0...12VDC 0...12VDC	10 bits or 10 bits or 12 bits	Terminal 2 Terminal 3	TM3AI4H TM3AI4H	0,110 0,230
4 enhancement or temperature inputs	-10...+10VDC 0...20mA, 4...20mA	0...12VDC 0...12VDC	10 bits or 10 bits or 12 bits	Terminal 2 Terminal 3	TM3AI4T TM3AI4T	0,110 0,230
4 differential temperature inputs	-10...+10VDC 0...20mA, 4...20mA	0...12VDC 0...12VDC	10 bits or 10 bits or 12 bits	Terminal 2 Terminal 3	TM3AI4D TM3AI4D	0,110 0,230

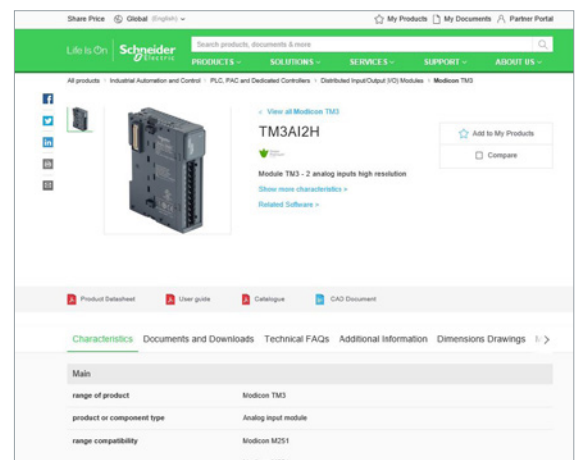

Each commercial reference presented in a catalog contains a hyperlink. Click on it to obtain the technical information of the product:

- Characteristics, Dimensions and drawings, Mounting and clearance, Connections and schemas, Performance curves
- Product image, Instruction sheet, User guide, Product certifications, End of life manual

Find your catalog

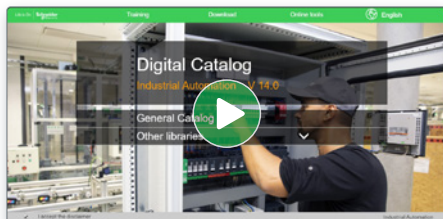

- > With just 3 clicks, you can access the Industrial Automation and Control catalogs, in both English and French
- > Consult digital automation catalogs at [Digi-Cat Online](#)

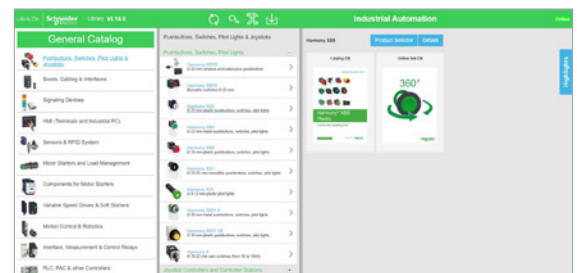

- Up-to-date catalogs
- Embedded product selectors, 360° pictures
- Optimized search by commercial references

Select your training



- > Find the right [Training](#) for your needs on our Global website
- > Locate the training center with the selector tool, using this [link](#)

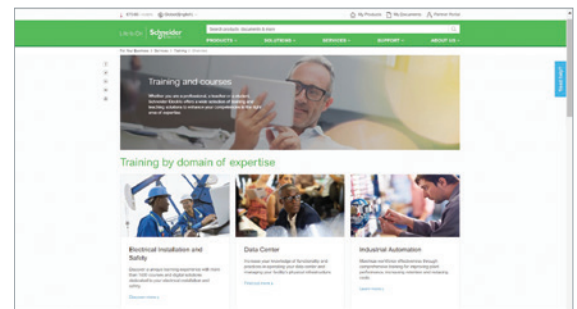

General contents

EcoStruxure Control Expert	1
EcoStruxure Control Expert Companion	2
EcoStruxure Control Engineering	3
EcoStruxure OPC UA Server Expert . . .	4
OPC Data Server software, OFS (OPC Factory Server)	5
EcoStruxure Process Expert	6
Product reference index	7

In this catalog, each time words which refer to Safety without precision, must be understood according to "Functional Safety": IEC61508 & IEC61511.

Schneider Electric's IoT-enabled, plug-and-play, open, secure, interoperable architecture and platform, in Industries, Infrastructures, Data Centers, and Buildings.

Innovation at every level

EcoStruxure is based on a three-tiered technology stack delivering innovation at every level, from connected products to edge control and apps, analytics, and services.

Together with our hybrid segments approach, this enhances your value around safety, reliability, operational efficiency, sustainability, and connectivity across 6 domains of expertise:

- Power
- IT
- Building
- Machine
- Plant
- Grid

Dedicated architectures and IoT

We tailor our solutions in the form of dedicated reference architectures for plants:

- Management systems
- Power systems
- Data center systems
- Industrial plant and machine systems
- Smart grid systems

The Industrial Internet of Things (IIoT) gives an additional boost to technologies. That's why we provide our customers with an IoT-enabled architecture and platform offering simple, reliable, productive, and cost-efficient solutions.

Cybersecurity solutions

Robust cybersecurity protection is a must, and Schneider Electric's solutions can deliver it, regardless of business type or industry.

The vendor-agnostic services provided by our skilled professionals help to protect your entire critical infrastructure. We help to assess your risk, implement cyber-specific solutions, and maintain your onsite defenses over time, while integrating appropriate IT policies and requirements.

This is our difference and your advantage.

Enhanced safety

With the release of M580 Safety, Schneider Electric further expands the EcoStruxure platform.

This consolidates our position as one of the most trusted industrial safety vendor, with thousands of Modicon and Triconex safety systems protecting the most critical industrial processes globally.

EcoStruxure™ for Plant
Innovation At Every Level



*The Schneider Electric industrial software business and AVEVA have merged to trade as AVEVA Group plc, a UK listed company. The Schneider Electric and Life is On trademarks are owned by Schneider Electric and are being licensed to AVEVA by Schneider Electric.

EcoStruxure Control Expert

Selection guide	page 1/2
■ Presentation, functions	page 1/8
□ Unity Pro is renamed EcoStruxure Control Expert	page 1/8
□ Presentation	page 1/8
□ Topology Manager	page 1/8
□ PAC-to-PAC communication	page 1/9
□ Cybersecurity	page 1/9
□ FDT/DTM function	page 1/10
□ Programming languages	page 1/10
□ Program units	page 1/11
□ Common functional safety architecture on Modicon M580	page 1/11
□ Data editor	page 1/12
□ DFB user function blocks	page 1/12
□ Function block libraries	page 1/13
□ Debugging tools	page 1/14
□ PLC simulator	page 1/15
□ Trending tool	page 1/15
□ Documentation editor	page 1/15
□ System time stamping	page 1/15
□ Diagnostics integrated in Modicon M340, Modicon M580, Modicon M580 Safety, Premium, and Quantum automation platforms	page 1/16
□ Modifying the program with the PAC in RUN mode	page 1/17
□ Cross-references function	page 1/17
□ Import/export function	page 1/17
□ Application converters	page 1/18
□ Operating system update utilities	page 1/18
□ Online modification of the configuration (CCOTF)	page 1/18
□ Process control in machines	page 1/19
□ Communication drivers	page 1/21
□ Upgrade kits for Concept, PL7 Pro, and ProWORX software	page 1/21
□ EcoStruxure Control Expert update	page 1/21
□ How-to tutorials	page 1/21
■ References	page 1/22
□ EcoStruxure Control Expert licenses	page 1/22
□ EcoStruxure Control Expert Small V15 software	page 1/24
□ EcoStruxure Control Expert Large V15 software	page 1/25
□ EcoStruxure Control Expert Extra Large V15 software	page 1/26
□ EcoStruxure Control Expert Extra Large software with Topology Manager and M580 Safety	page 1/28
□ Topology Manager add-on for EcoStruxure Control Expert Extra Large V15 software	page 1/29
□ M580 Safety add-on for EcoStruxure Control Expert Large/Extra Large V15 software	page 1/30
□ Accessories for connecting to the PC programming terminal	page 1/31

Software

EcoStruxure Control Expert

Overview of basic, upgrade, and update references

Product family	Portability	Seats	Small (S)	Large (L)	Extra Large (XL)
Single Package Unit (SPU)	Node-locked	Single (1 user)	See page 1/24	See page 1/25	See page 1/26
		Group (3 users)			
		Team (10 users)			
		Entity (100 users)			
	Corporate (unlimited users)				
		Floating			Group (3 users)
Team (10 users)					
Entity (100 users)					
M580 Safety add-on (ADS)	Node-locked	Single (1 user)		See page 1/30	See page 1/30
		Group (3 users)			
		Team (10 users)			
		Entity (100 users)			
	Corporate (unlimited users)				
		Floating			Group (3 users)
Team (10 users)					
Entity (100 users)					
Topology Manager add-on (ADM) (1)	Node-locked	Single (1 user)			See page 1/29
		Group (3 users)			
		Team (10 users)			
		Entity (100 users)			
	Corporate (unlimited users)				
		Floating			Group (3 users)
Team (10 users)					
Entity (100 users)					
Bundle XL + TM + M580 Safety (SPM) (1)	Node-locked	Single (1 user)			See page 1/28
		Group (3 users)			
		Team (10 users)			
		Entity (100 users)			
	Corporate (unlimited users)				
		Floating			Group (3 users)
Team (10 users)					
Entity (100 users)					
Bundle XL + TM + M580 Safety (SPM) (1)	Floating	Education Entity (100 users)			See page 1/28

(1) Available Q1 2022

Product family	Portability	Seats	Small (S)	Large (L)	Extra Large (XL)
Seat Upgrade (UPN) for Single Package Unit	Node-locked	Single (1 user) to Group (3 users)	See page 1/24	See page 1/25	See page 1/27
		Group (3 users) to Team (10 users)			
	Team (10 users) to Entity (100 users)				
		Floating			Single (1 user) to Group (3 users)
Group (3 users) to Team (10 users)					
Team (10 users) to Entity (100 users)					
	Seat Upgrade (UMN) for Bundle XL + TM + M580 Safety	Node-locked	Single (1 user) to Group (3 users)		See page 1/28 and 1/29
Group (3 users) to Team (10 users)					
Team (10 users) to Entity (100 users)					
		Entity (100 users) to Corporate (unlimited users)			
Floating	Group (3 users) to Team (10 users)		See page 1/28 and 1/29		
	Team (10 users) to Entity (100 users)				
Size Upgrade (UPG) from Single Package Unit S or L to L and XL	Node-locked	Single (1 user) size upgrade		See page 1/25	See page 1/27
		Group (3 users) size upgrade			
		Team (10 users) size upgrade			
Entity (100 users) size upgrade					
	Corporate (unlimited users) size upgrade				
Size Upgrade (UPG) from Node-locked to Floating		Floating	Group Node-locked to Group Float		See page 1/27
	Team Node-locked to Team Float				
	Entity Node-locked to Entity Float				
Portability Upgrade (UMF) for Bundle XL + TM + M580 Safety (1)	Floating	Group Node-locked to Group Float			See page 1/29
		Team Node-locked to Team Float			
		Entity Node-locked to Entity Float			
Version Update (UPD) for Single Package Unit, version N to latest major version (e.g. V14 to V15)	Node-locked	Single (1 user)	See page 1/24	See page 1/25	See page 1/26
		Group (3 users)			
	Team (10 users)				
		Entity (100 users)			
Floating	Group (3 users)		See page 1/26		
	Team (10 users)				
Entity (100 users)					
M580 Safety add-on Update (UAS)	Node-locked	Single (1 user)		See page 1/30	See page 1/30
		Group (3 users)			
	Team (10 users)				
		Entity (100 users)			
Floating	Group (3 users)				
	Team (10 users)				
Entity (100 users)					
Bundle XL+ TM + M580 Safety Update (UMD) (1)	Node-locked	Corporate (unlimited users)			See page 1/28
	Floating	Education Entity (100 users)			See page 1/28

(1) Available Q1 2022



More technical information on www.se.com



More technical information on www.se.com

Software

EcoStruxure Control Expert

Small, Large, Extra Large

EcoStruxure Control Expert programming software for Modicon M340 M, Modicon M580 M5, Modicon M580 Safety M5S, Modicon Momentum MM, Premium P, Quantum Q, Quantum Safety QS, and Modicon distributed I/O D platforms			
IEC 61131-3 languages	Instruction List (IL)	M - MM - D	
	Ladder (LD)	M - MM - D	
	Structured Text (ST)	M - MM - D	
	Function Block Diagram (FBD)	M - MM - D	
	Sequential Function Chart (SFC)/Grafcet	M - MM - D	
Ladder Logic Language LL984			
Programming services	Multitask programming (master, fast and event-triggered)	M - MM (master task only) - D	
	Multitask programming (master, fast, auxiliary and event-triggered)		
	Functional view and function modules	M - MM - D	
	Program units	M	
	DFB editor and instances	M - MM - D	
	DDT compound data editors	M - MM - D	
	Data structure instances and tables	M - MM - D	
	EF and EFB libraries	M - MM - D	
	User-definable control loops		
	Programmable control loops (with process control FB library)	M - MM - D	
	Safety function block libraries		
	Motion function block (MFB) libraries	M - MM - D	
	Hot Standby PAC redundant system		
	System and application diagnostics	M - MM - D	
	Bus and network configuration to slave devices (Modicon distributed I/O, etc.)	M - MM - D	
	Topology Manager	Multi-controller architecture	
		Network consistency	
		Client-server architecture	
System diagnostics			
Debugging and display services	PLC simulator	M - MM - D	
	Hypertext link animations in graphic languages	M - MM - D	
	Step-by-step execution, Breakpoint, Watchpoint	M - MM - D	
	Trending tool	M - MM - D	
	Operator screens, Animation tables	M - MM - D	
	Diagnostics viewer	M - MM - D	
Other services	Creation of hyperlinks	M - MM - D	
	XML/XVM import/export	M - MM - D	
	Application converters (Modsoft, Concept, ProWORX, PL7)	M	
	Utilities for updating PACs and Advantys operating system	M - MM - D	
	Communication drivers for Modicon platforms	M - MM - D	
	Unity Pro servers - Openness (OFS, third-party tools)	M - MM - D	
	Online modification of the configuration		
	Online modification of the program	M - MM - Q	
	Importing of applications (Modsoft, Concept, ProWORX) written in LL984 language	M - MM	
	Data dictionary, Dynamic exchange with SCADA through OFS	M - MM - D	
	Static exchange via XML/XVM export files	M - MM - D	
Compatible Modicon platforms	Modicon M340 CPUs M	All models	
	Modicon M580 CPUs M5	-	
	Modicon M580 Safety CPUs M5S	-	
	Modicon Momentum CPUs MM	171CBU78090/98090/98091	
	Premium CPUs P	-	
	Quantum CPUs Q	-	
Quantum Safety CPUs S	-		
Compatible Modicon distributed I/O D			
		STB, OTB, TM7, ETB, Momentum	

EcoStruxure Control Expert software name	EcoStruxure Control Expert Small
EcoStruxure Control Expert software package	CEXSPUCZS●PMZZ
Software license, see page	1/24

EcoStruxure Control Expert programming software for Modicon M340 M, Modicon M580 M5, Modicon M580 Safety M5S, Modicon Momentum MM, Premium P, Quantum Q, Quantum Safety QS, and Modicon distributed I/O D platforms		
M - M5 - MM - P - Q - D	M - M5 - MM - P - Q - D	
M - M5 - MM - P - Q - D	M - M5 - MM - P - Q - D	
M - M5 - MM - P - Q - D	M - M5 - MM - P - Q - D	
M - M5 - MM - P - Q - D	M - M5 - MM - P - Q - D	
M - M5 - MM - P - Q - D	M - M5 - MM - P - Q - D	
M - M5 - MM - Q	M - M5 - MM - Q	
M - M5 - MM (master task only) - P - Q - D	M - M5 - MM (master task only) - P - Q - D	
M5	M5 - P (TSXP575●) - Q (140CPU651/671) - D	
M - M5 - MM - P - Q - D	M - M5 - MM - P - Q - D	
M - M5	M - M5	
M - M5 - MM - P - Q - D	M - M5 - MM - P - Q - D	
M - M5 - MM - P - Q - D	M - M5 - MM - P - Q - D	
M - M5 - MM - P - Q - D	M - M5 - MM - P - Q - D	
M - M5 - MM - P - Q - D	M - M5 - MM - P - Q - D	
M - M5 - MM - P - Q - D	M - M5 - MM - P - Q - D	
P (TSXP572●/3●/4●) - D	P (TSXP572●/3●/4●/5●) - D	
M - M5 - MM - P - Q - D	M - M5 - MM - P - Q - D	
M - M5 - MM - P - Q - D	M - M5 - MM - P - D	
M5 - P (TSXH5724M/44M) - D	M5 - P (TSXH5724M/44M) - Q (140CPU67160) - D	
M - M5 - MM - P - Q - D	M - M5 - MM - P - Q - D	
M - M5 - MM - P - Q - D	M - M5 - MM - P - Q - D	
M - M5 - MM - P - Q - D	M - M5 - MM - P - Q - D	
M - M5 - MM - P - Q - D	M - M5 - MM - P - Q - D	
M - M5 - MM - P - Q - D	M - M5 - MM - P - Q - D	
M - M5 - MM - P - Q - D	M - M5 - MM - P - Q - D	
M - M5 - MM - P - Q - D	M - M5 - MM - P - Q - D	
M - M5 - MM - P - Q - D	M - M5 - MM - P - Q - D	
M - M5 - MM - P - Q - D	M - M5 - MM - P - Q - D	
M - M5 - MM - P - Q - D	M - M5 - MM - P - Q - D	
M - M5 - MM - P - Q - D	M - M5 - MM - P - Q - D	
M - M5 - MM - P - Q - D	M - M5 - MM - P - Q - D	
M - M5 - MM - P - Q - D	M - M5 - MM - P - Q - D	
M - M5 - MM - P - Q - D	M - M5 - MM - P - Q - D	
M - M5 - MM - P - Q - D	M - M5 - MM - P - Q - D	
M5 - Q	M5 - Q	
M - M5 - MM - P - Q	M - M5 - MM - P - Q	
M - MM - Q	M - M5 - MM - Q	
M - M5 - MM - P - Q - D	M - M5 - P - Q - D	
M - M5 - MM - P - Q - D	M - M5 - MM - P - Q - D	
All models	All models	
BMEP5810/5820/5830/BMEH5820	All models	
BMEP582040S/BMEH582040S (with M580 Safety add-on CEXADSSCZZ●PMZZ)	All models (with M580 Safety add-on CEXADSSCZZ●PMZZ)	
171CBU78090/98090/98091	171CBU78090/98090/98091	
TSXP57104M/1634M/154M, TSXP57204M/2634M/254M	All models	
TSXP57304M/3634M/354M, TSXP574634/454M, TSXH5724/44M		
140CPU31110, 140CPU43412U, 140CPU53414U	All models	
-	-	
STB, OTB, TM7, ETB, Momentum	STB, OTB, TM7, ETB, Momentum	

EcoStruxure Control Expert Large	EcoStruxure Control Expert Extra Large
CEXSPUCZL●PMZZ	CEXSPUCZX●PMZZ
1/25	1/26

Software

EcoStruxure Control Expert Small/Large/Extra Large/Extra Large with Topology Manager and M580 Safety

1



EcoStruxure Control Expert

Unity Pro is renamed EcoStruxure Control Expert

In line with EcoStruxure™ strategy and values, Unity Pro, our Engineering software for the Modicon PAC platform for hybrid and process industries, has been renamed EcoStruxure™ Control Expert.

Presentation

This catalog describes EcoStruxure Control Expert software V15, which is the latest version available.

EcoStruxure Control Expert is the common programming, debugging, and operating software for the Modicon M340, M580, M580S, Premium, Momentum, and Quantum ranges.

Note: Please use Unity Pro software V7 for Quantum SIL3 (safety integrity level 3).

EcoStruxure Control Expert is multitasking software offering the following features:

- All-in-one software
- Five IEC 61131-3 programming languages
- LL 984 programming language
- Device integration with FDT/DTM standard
- Integrated, customizable DFB library
- Topology Manager
- PAC-to-PAC communication
- PLC simulator on PC for program validation prior to installation
- Built-in tests and diagnostics
- Wide range of online services
- Cybersecurity

EcoStruxure Control Expert supports the new M580 Safety PACs, mixing process and functional safety in a single project. It allows users to:

- Optimize engineering time
- Simplify programming with IEC 61508 functions
- Facilitate maintenance

EcoStruxure Control Expert is available in two modes:

- Classic mode for single-controller architectures, with Topology Manager license that can work in Topology Manager mode
- Topology Manager mode for multi-controller architectures

Topology Manager

EcoStruxure Control Expert V15 with the new Topology Manager offers a common environment to design, engineer, commission, operate, and maintain a complete plant. The multi-controller architecture in graphical tree representation makes the design and deployment of entire multi-PAC systems, including the various types of automation assets, very easy.

The intuitive design workflow (drag/drop, copy/paste) is created for the global administration of complete architecture. A consistent update of the logical network view with automatic assignment of IP address allows you to update a project easily, reducing engineering maintenance and total lifecycle costs. During commissioning, users will also be able to deploy one or a group of controllers/assets in one click, thus reducing time and engineering costs.

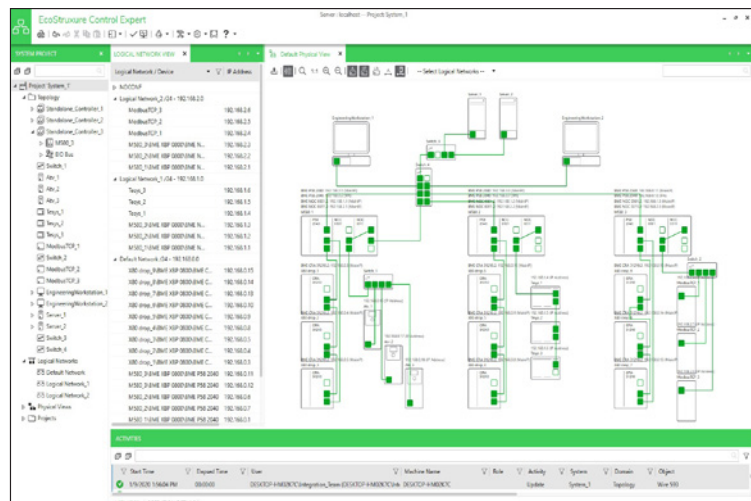

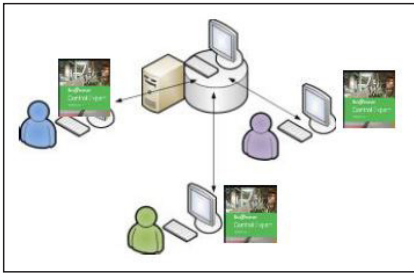

Client-Server model

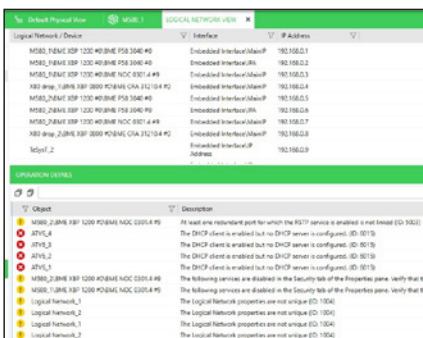

Network consistency check

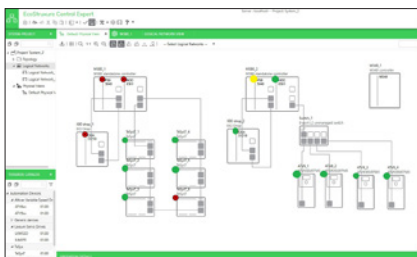

System diagnostics

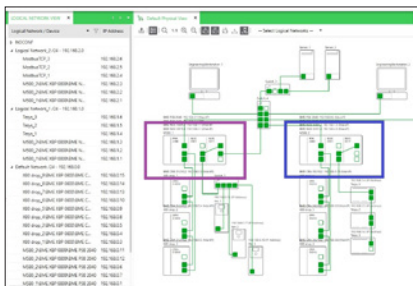

Implicit messaging

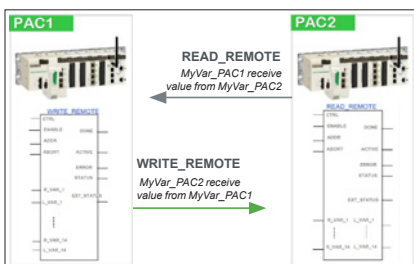

Explicit messaging

Topology Manager (continued)

Client-server model

The client-server model enables multiple engineers to work concurrently on the same project. The central repository (single global database) enables active services to share information across all automation system components as well as share real-time engineering data with all users, thus helping to maintain data consistency.

Network consistency

The accuracy and consistency of the network design can be analyzed and automatically validated with just one click. Detected errors or warnings are reported with detailed instructions for easy correction.

System diagnostics

The system diagnostics provides live statistics for the entire plant during the operation or commissioning phase. Detected errors are localized and analyzed in real time. The intuitive interface also helps to easily visualize these detected errors and resolve them quickly to boost efficiency.

PAC-to-PAC communication

The PAC-to-PAC communication is made flexible and easy with:

- Explicit messaging with READ_REMOTE and WRITE_REMOTE communication function blocks. These blocks enable exchange of variables by using the name of the variable between M580 and M340 PLCs.
- Implicit messaging with local slave being configured in Topology Manager and checked for consistency

Cybersecurity

Schneider Electric constantly endeavours to maintain the security of its systems. Security guidelines are available for our customers to help ensure their systems are protected from attack.

The Modicon M340, M580, M580S, Premium, Momentum, and Quantum automation platforms feature:

- Protection against remote programming changes via a password
- Option to enable or disable HTTP or FTP services

With the Modicon M580 automation platform:

- Log of security events in the SYSLOG database
- Extended Ethernet services management (DHCP, etc.) can be set for each user in the Access Control List
- More secure IPsec communication between EcoStruxure Control Expert or SCADA and PAC



Software

EcoStruxure Control Expert

Small/Large/Extra Large/Extra Large

with Topology Manager and M580 Safety

1

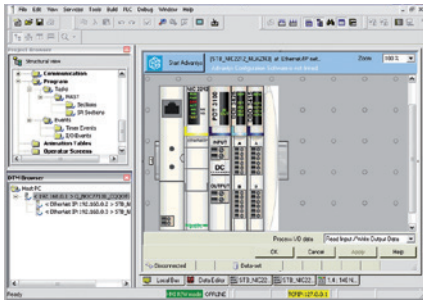

DTM editor (Modicon STB island)

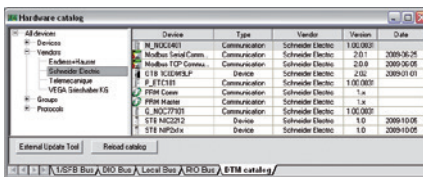

DTM hardware catalog

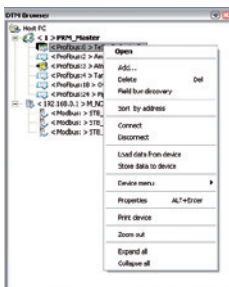

DTM Browser and DTM context menu

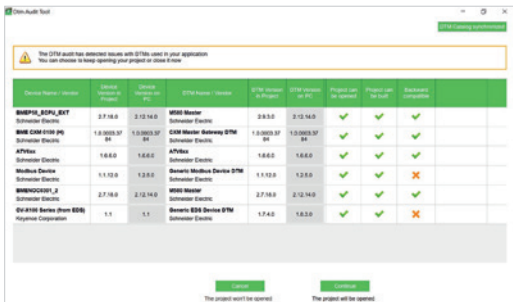

DTM Audit Tool screen

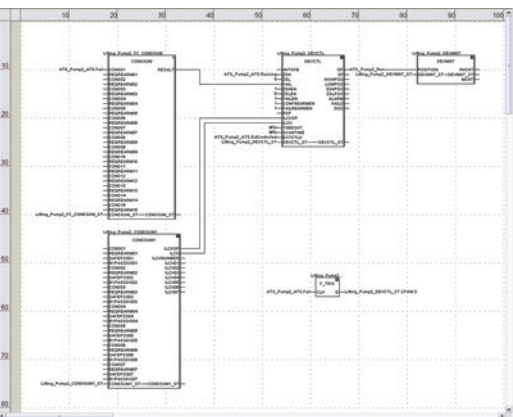

FBD language editor

FDT/DTM function

EcoStruxure Control Expert facilitates integration of fieldbus architectures into engineering control systems using FDT/DTM technology:

- FDT (Field Device Tool) is the container which supports the device DTMs.
- DTM (Device Type Manager) is the configuration tool for devices with integrated graphic interfaces. It contains the properties specific to each device .

In addition to the FDT/DTM standard, the software uses specific information from the Master DTM created for the Profibus Remote Master (PRM) module, the HART module, the Premium ISPY101 weighing module, Altivar process drive integration, and the Modbus/TCP and EtherNet/IP network modules BMXNOC0401 and BMENOC0301.

Use of the Master DTM allows EcoStruxure Control Expert to perform the following actions:

- Manage the PAC I/O scan
- Create the application variables based on the description of the process objects available from the connected DTM devices
- Manage synchronization with the PAC configuration
- Create a generic DTM from the description files (GSD or EDS)

The DTM configuration is stored in the PAC memory so that the application can be downloaded in its entirety. It is also saved in the PAC project file (STU), the archive file (STA), and the full application exchange file (ZEF).

A third-party DTM can be installed in the DTM hardware catalog. The DTM hardware catalog can be used to sort or filter the DTMs according to various criteria such as device, vendor, groups, or protocols.

The DTM Browser in EcoStruxure Control Expert:

- Displays the fieldbus topologies in a tree structure
- Allows the user to configure the DTM devices:
 - add and delete DTMs
 - connect and disconnect DTMs to/from their physical devices
 - display and print the properties of a DTM
 - transfer DTM configuration data to and from the physical device
 - execute functions specific to the DTM, via the Device menu

The fieldbus discovery function scans the physical devices in a fieldbus network and adds the selected devices to the DTM Browser.

DTM Audit Tool is provided to have a clear vision of the DTM versions embedded in a project and the versions installed on the PC. Depending on the DTM version compatibility, the tool informs the user if the project can be opened and built.

Programming languages

The five IEC 61131-3 compliant languages

The five graphical or textual languages available in EcoStruxure Control Expert are used for programming Modicon M340, Modicon M580, Modicon M580 Safety, Modicon Momentum, Premium, and Quantum automation platforms.

The three graphical languages are:

- Ladder (LD) language
- Function Block Diagram (FBD)
- Sequential Function Chart (SFC) or Grafcet

The two textual languages are:

- Structured Text (ST)
- Instruction List (IL)

For these five languages, you can use the standard set of instructions compliant with IEC standard 61131-3 to create applications that can be transferred from one platform to another. EcoStruxure Control Expert software also provides extensions to this standard set of instructions. As they are specific to Modicon M340, Modicon M580, Modicon M580 Safety, Modicon Momentum, Premium, and Quantum automation platforms, these extensions support the development of more complex applications in order to maximize the potential of the specific features of each of these platforms.

LL984 language

LL984 (Ladder Logic 984) language enables migration from legacy Modicon ranges. It is used to program Modicon M580, Modicon M580 Safety, Modicon M340, Momentum, and Quantum automation platforms.

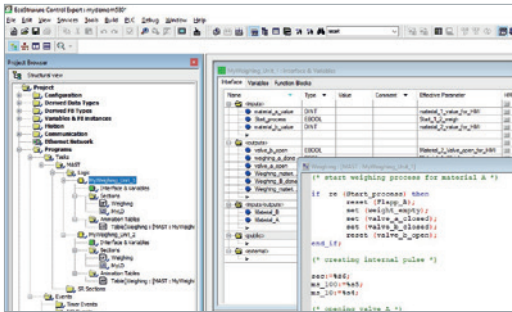

Program units

Program units

Program units are compliant with Program Organization Units (POUs) as defined in standard IEC 61131-3.

Program units are autonomous programming entities (only available for Modicon M580 and M340). Program units allow easy duplication and clear organization of a program with local and public variables.

The program unit includes:

- Public and local variables
- Sections
- Animation tables

The following programming languages are supported:

- FBD (Function Block Diagram)
- LD (Ladder Diagram Language)
- SFC (Sequential Function Chart) only for sections in the program unit that belong to the MAST task
- IL (Instruction List)
- ST (Structured Text)

Common functional safety architecture on Modicon M580 (1)

Presentation

The EcoStruxure Control Expert user-friendly interface for Modicon automation platforms family is now available for functional safety.

EcoStruxure Control Expert allows users to:

- Manage a complete control and functional safety automation system from design to operation and maintenance.
- Increase productivity during engineering, commissioning, and operation for both process and safety, reducing time to market.

EcoStruxure Control Expert makes it possible to design a common safety architecture by executing:

- The Safety functions of your process in specific Safety tasks
- Standard functions in other tasks

All X80 Safety I/O are managed through Safety tasks, and standard and non-interfering X80 modules are managed in other tasks. This means it is possible to mix functional safety and standard X80 modules in the same M580 Safety PAC.

IEC 61131-3 compliant languages

FBD and LD are supported in the SAFE task. The SAFE task has two modes for operation and maintenance:

- Safety mode: During operation, the SAFE task is running and is locked for users.
- Maintenance mode: Dedicated to maintenance operations in the functional safety part of the application.

Data editor

PROCESS and SAFE data are managed in a distinct M580 memory area.

EcoStruxure Control Expert allows users to easily manage:

- Exchange of data between PROCESS and SAFE areas of the project in "Data Editor"
- Process data in the "PROCESS Data Editor"
- Functional safety data in the "SAFE Data Editor"

Safety function blocks

EcoStruxure Control Expert supports new M580 Safety offers with IEC 61508 programming languages and a rich library of Safety function blocks.

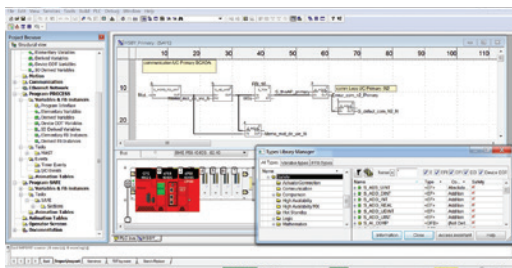

Safety function block

(1) Available from V13.

1

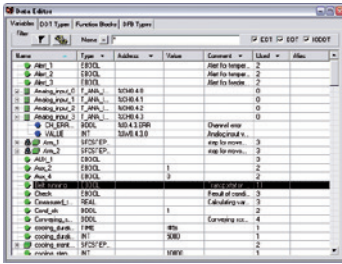

Data editor

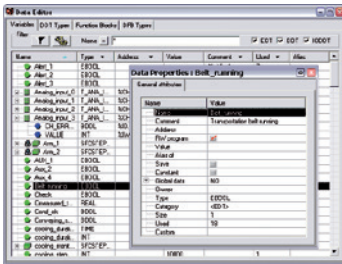

Data properties

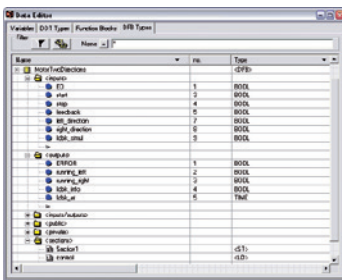

Design

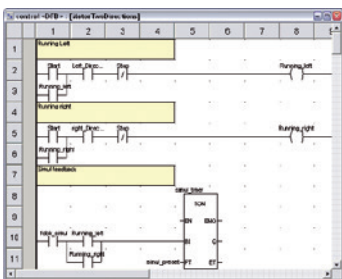

Creating the code

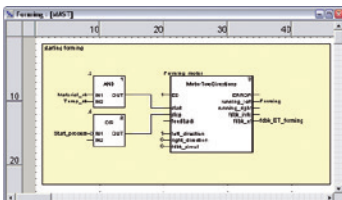

Use within the program

Data editor

The data editor provides a single tool for performing the following editing tasks:

- Declaration of data including variables and function blocks (declaration of their type, instances, and attributes)
- Use and archiving of function block data types in different libraries
- Hierarchical view of data structures
- Searching, sorting, and filtering of data
- Creation of a hyperlink to access a description from any variable comment

The data is displayed in four tabs:

- “Variables” tab for the creation and management of the following data instances: bits, words, double words, inputs/outputs, tables, and structures
- “DDT Types” tab for the creation of derived data types (tables and structures)
- “Function Blocks” tab for the declaration of EFBs and DFBs
- “DFB Types” tab for the creation of DFB user function block data types

Each data element has several attributes, of which:

- Variable name and type are mandatory
- Comment, physical address in the memory, and initial values are optional

The data editor columns can be configured (number of columns, order). The attributes associated with a variable can be displayed in a properties window.

This editor can be accessed at any time during programming by selecting variables for data modification or creation.

DFB user function blocks

With EcoStruxure Control Expert software, users can create their own function blocks for specific application requirements on Modicon M340, Modicon M580, Modicon M580 Safety, Modicon Momentum, Premium, and Quantum platforms.

Once created and saved in the library, these user function blocks can be reused as easily as EFBs (elementary function blocks).

The user function blocks can be used to structure an application. They are used when a program sequence is repeated several times in the application or for freezing a standard programming routine. They can be read-only or read/write. They can be exported to other EcoStruxure Control Expert applications.

Using a DFB in one or more applications:

- simplifies program design and entry
- improves program readability and understanding
- facilitates program debugging (variables handled by the DFB are identified in the data editor)
- enables the use of private variables specific to the DFBs, which are independent of the application

A DFB is set up in several stages:

- The DFB is designed by assigning a name, a set of parameters (inputs, outputs, public and private internal variables) and a comment to it via the data editor.
- The code is created in one or more sections of the program, with the following languages selected according to requirements: Structured Text, Instruction List, Ladder, or Function Block Diagram (ST, IL, LD, or FBD).
- The DFB can be stored in a library with an associated version number.
- A DFB instance is created in the data editor or when the function is called in the program editor.
- This instance is used in the program in the same way as an EFB (the instance can be created from within the program).

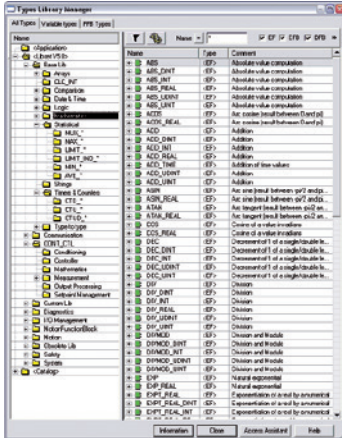

Standard function block libraries

Function block libraries

The function and function block libraries manager contains the elements provided with EcoStruxure Control Expert software. Functions and function blocks are organized into libraries, which themselves consist of families. Depending on the type of PAC selected and the processor model, users will have a subset of these libraries available to write their applications. However, the “Base Lib” library contains a set of functions and function blocks, for the majority of which compatibility is independent of the platforms. In particular, it contains the blocks compliant with IEC 61131-3. The “Base Lib” library is structured into families:

- Timers and counters
- Process control on integers
- Table management
- Comparison
- Date and time management
- Logic processing
- Mathematical processing
- Statistical processing
- Character string processing
- Type-to-type data conversion

The “Base Lib” library, which covers standard automation functions, is supplemented by other, more application-specific libraries and platform-specific functions:

- **Communication library**, providing an easy means of integrating communication programs from PACs with those used by HMIs from the PAC application program. Like other function blocks, these EFBs can be used in any language to exchange data between PACs or to deliver data to be displayed on an HMI.
- **Process control library**. The CONT_CTL library can be used to set up process-specific control loops. It offers controller, derivative, and integral control functions and additional algorithms, such as EFBs for calculating mean values, selecting a maximum value, detecting edges, or assigning a hysteresis to process values, etc.
- **Diagnostics library**, which can be used to monitor actuators and contains EFBs for active diagnostics, reactive diagnostics, interlocking diagnostics, permanent process condition diagnostics, dynamic diagnostics, monitoring of signal groups, etc.
- **I/O management library**, providing services to handle information exchanged with hardware modules (formatting data, scaling, etc.).
- **Motion Function Block library**, containing a set of predefined functions and structures to manage motion controlled by drives and servo drives connected on CANopen.
- **Motion library** for motion control and fast counting.
- **System library**, which provides EFBs for the execution of system functions, including: evaluation of scan time, availability of several different system clocks, SFC section monitoring, display of system status, management of files on the memory cartridge of the Modicon M340 processor, M580 processor, etc.
- Finally, a library named “obsolete”, containing the function blocks used by legacy programming software needed to perform application conversions.

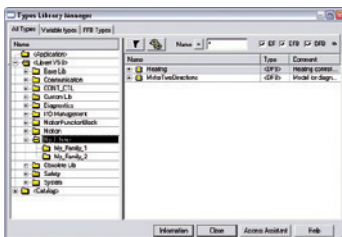

User libraries

Management of user standards

Users can create libraries and families in order to store their own DFBs and DDTs. This enhancement allows users to take advantage of programming standards adapted to their needs, along with version management. This means that it is possible to:

- Check the version of the elements used in an application program against those stored in the library
- Perform an upgrade, if necessary

1

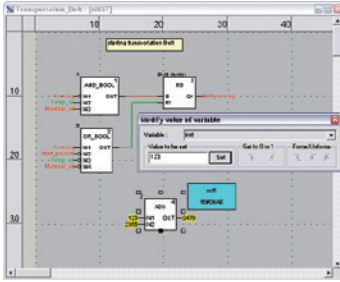

Debugging tools: Dynamic animation/adjustment

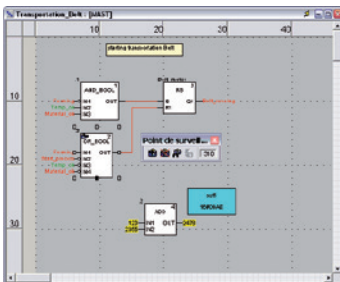

Debugging tools: Watchpoint

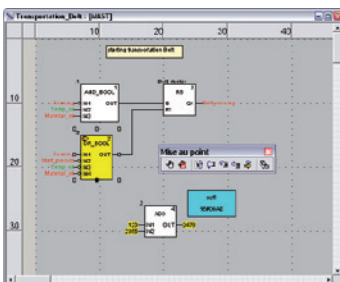

Debugging tools: Breakpoint/step-by-step

Debugging tools

EcoStruxure Control Expert software offers a complete set of tools for debugging Modicon M340, M580, M580S, Momentum, Premium, or Quantum applications. A tool palette provides direct access to the main functions:

- Dynamic program animation
- Setting of watchpoints or breakpoints (not authorized in event-triggered tasks)
- Step-by-step program execution. A function in this mode enables section-by-section execution. Instruction-by-instruction execution can be launched from the previous breakpoint. Three execution commands are therefore possible when the element to be processed is a subroutine (SR) or DFB user block instance:
 - Step Into: This command is used to move to the first element of the SR or DFB.
 - Step Over: This command is used to execute the entire SR or DFB.
 - Step Out: This command is used to move to the next instruction after the SR or DFB element.
- Independent execution of the master (MAST), fast (FAST), auxiliary (AUX), and event-triggered (EVTi) tasks

Animation of program elements

Dynamic animation is managed section-by-section. A button on the toolbar is used to activate or deactivate animation for each section.

When the PAC is in RUN, this mode can be used to simultaneously view:

- The animation of a program section, regardless of the language used
- The variables window containing the application objects created automatically from the section viewed

Animation table

Tables containing the variables of the application to be monitored or modified can be created by data entry or initialized automatically from the selected program section. The tables can be stored in the application and retrieved from there at a later date.

EcoStruxure Control Expert can be used to save, import, and export Animation tables with predefined set values. As it allows population of set values along with current values and vice versa in the PAC, Animation tables can be used as templates to make the application easier to tune.

Debugging DFB user function blocks

The parameters and public variables of these blocks are displayed and animated in real time using animation tables, with the possibility of modifying and forcing the required objects.

In exactly the same way as with other program elements, the watchpoint, breakpoint, step-by-step execution, and program code diagnostics functions can be used to analyze the behavior of DFBs. Setting a breakpoint in a DFB user function block instance stops execution of the task containing this block.

Debugging in Sequential Function Chart (SFC) language

The various debugging tools are also available in SFC language. However, unlike other sections (IL, ST, LD, or FBD), an SFC section executed step-by-step does not stop execution of the task but instead freezes the SFC chart. Several breakpoints can be declared simultaneously within a single SFC section.

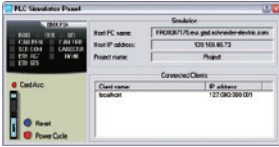

Simulator control panel

PLC simulator

The EcoStruxure Control Expert integrated simulator can be used to test the application program for Modicon M340, M580, M580S, Momentum, Premium, or Quantum automation platforms from the PC terminal without having to connect to the processor. The functions provided by the debugging tools are available for debugging the master, fast, and auxiliary tasks.

As the simulator does not manage the PLC I/O, animation tables can be used to simulate the state of inputs by forcing them to 0 or 1.

The simulator can be connected to third-party applications via an OPC server with OFS (OPC Factory Server) software.

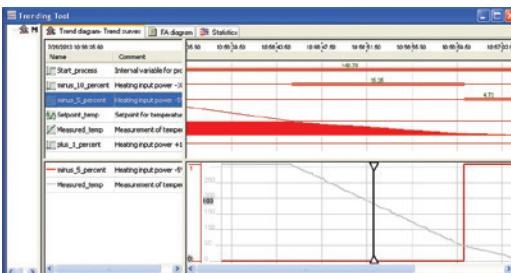

Trending tool control panel

Trending tool

The trending tool allows easy monitoring of variables by detecting operating problems or improving process performance. You can select any variable in your application and start acquisition, save records, and analyze records with integrated tools or Excel. The PAC master scan can scan up to 16 variables.

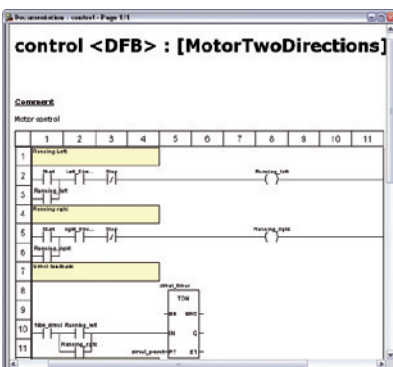

Accessing the documentation editor

Documentation editor

The documentation editor is based on the Documentation Browser, which shows the file structure in tree form.

It allows all or part of the application file to be printed on any graphics printer accessible under Windows using True Type technology, in A4 or US letter print format.

The documentation editor supports the creation of user-specific files using the following headings:

- Title page
- Contents
- General information
- Footer
- Configuration
- EF, EFB, and DFB type function blocks
- User variables
- Communication
- Project structure
- Program
- Animation tables and cross-references
- Runtime screens

System time stamping

System mode allows time stamping of I/O or internal variables for easy management via OFS and SCADA. Programming or use of any function block is not required as the configuration is easy to perform in EcoStruxure Control Expert Data Editor supported by OFS version 3.51.

Diagnostics integrated in Modicon M340, Modicon M580, Modicon M580 Safety, Premium, and Quantum automation platforms

Presentation

System diagnostics

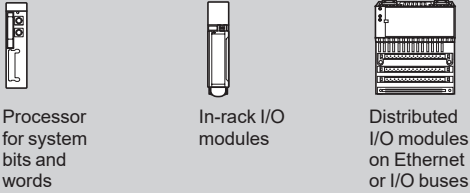

Application diagnostics

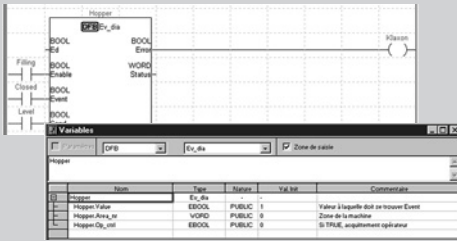

Diagnostics viewers

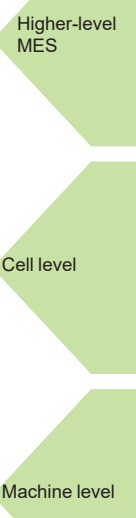
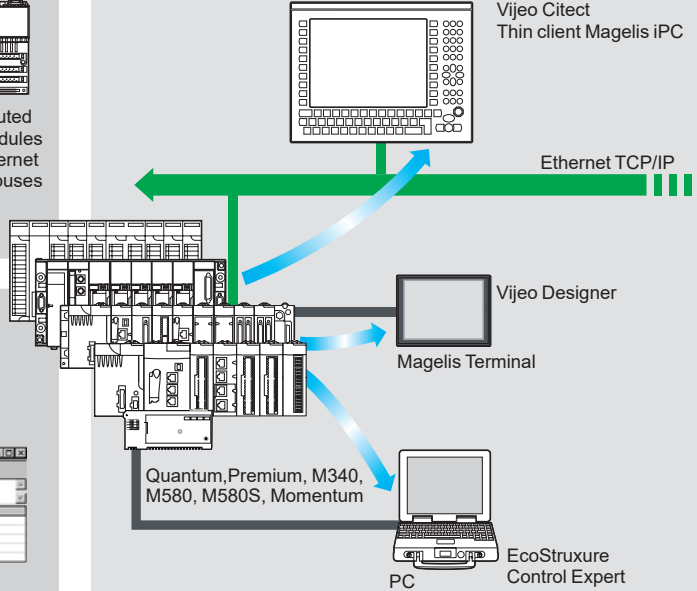

The diagnostics offer for Modicon M340, M580, M580S, Momentum, Premium, and Quantum platforms is based on the following three components:

- System diagnostics
- DFB and EFB diagnostic function blocks (for system and application diagnostics)
- Detected error message display system, called viewers, supplied as a standard component of Magelis terminal, Vijeo Citect supervisory software, and EcoStruxure Control Expert setup software

System diagnostics

The system diagnostics for the Modicon M340, M580, M580S, Momentum, Premium, and Quantum platforms support the monitoring of system bits/words, I/O modules, and activity times (minimum/maximum) of SFC steps. By simply choosing the relevant option during application configuration, any event will generate time-stamped messages logged in the diagnostic buffer of the PAC.

These events are displayed automatically in a diagnostics viewer (1) without requiring any additional programming.

With EcoStruxure Control Expert integrated diagnostics, this function can be used to perform first-level diagnostics of the elements in the configuration, up to and including each I/O module channel.

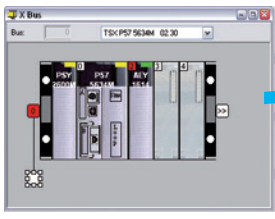

Configuration level

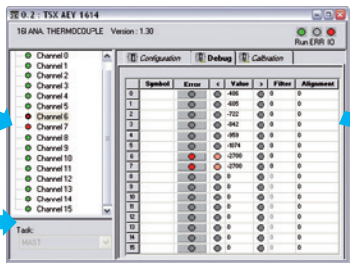

Module level



Viewer window (example with EcoStruxure Control Expert software)

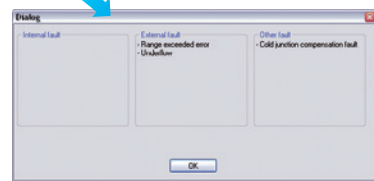

Channel level

(1) Diagnostics viewers are tools for displaying and acknowledging diagnostic detected error messages. They are supplied as a standard component of EcoStruxure Control Expert and Vijeo Designer software, with Magelis terminals and with the PLC web server that can be accessed via a thin client Magelis iPC.

Software

EcoStruxure Control Expert

Small/Large/Extra Large/Extra Large

with Topology Manager and M580 Safety

Modifying the program with the PAC in RUN mode

With EcoStruxure Control Expert, changes can be made to the program when the PAC connected to the programming terminal is in RUN mode. These modifications are performed with the following operations:

- The application contained in the PAC is transferred to the PC terminal running EcoStruxure Control Expert, if necessary.
- Program changes are prepared. These program modifications can be of any type and in any language (IL, ST, LD, FBD, and SFC), for example, addition or deletion of SFC steps or actions. The code of a DFB user function block can also be modified (however, modification of its interface is not permitted).
- These program changes are updated in the PAC (in RUN mode).

This function makes it possible to add or modify program code and data in different parts of the application during a single modification session (thus resulting in a uniform, consistent modification with respect to the controlled process). This increased flexibility comes at a cost in terms of the amount of program memory required.

Cross-references function

The EcoStruxure Control Expert cross-references function, which is available in standalone mode (offline) and when connected to the PAC in RUN (online), allows users to view the elements of a PAC application when searching for any type of variable. This view indicates where the declared variable is used, as well as how it is used (for writing, reading, etc.).

This function also provides access to the Search/Replace function for variable names.

The variable search can be initialized from any editor (language, data, runtime screen, animation table, etc.).

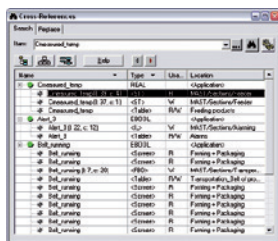

Cross-references table

Import/export function

The import/export function available in EcoStruxure Control Expert supports the following operations from the structural and functional project views:

- Via the import function, reuse of all or part of a previously created project in the current project
- Via the export function, copying of all or part of the current project to a file for subsequent reuse

The files generated during export are generally in XML format (1). However, in addition to XML, variables can be exported and imported in the following formats:

- .xvm format compatible with OFS data server software
- source format, in an .scy file compatible with PL7 development software
- text format with separator (Tab) in a .txt file for compatibility with any other system

During an import, a wizard can be used to reassign data to new instances of:

- DFB function blocks
- DDT data structures
- simple data

In addition, when a functional module is imported, the data associated with animation tables and runtime screens is also reassigned.

The XML import function also supports the transfer of a Modicon M340, Modicon M580, Modicon M580 Safety, Premium, or Quantum PAC configuration prepared in the SIS Pro costing and configuration tool for use in the creation of a project in EcoStruxure Control Expert. This import function spares the user from having to redefine the PAC configuration when the PAC has already been configured with the SIS Pro tool.

EcoStruxure Control Expert includes an Excel import/export tool that makes it easy to manage the variables using an XML export file in Excel.

(1) XML language is an open, text-based language that provides structural and semantic information .

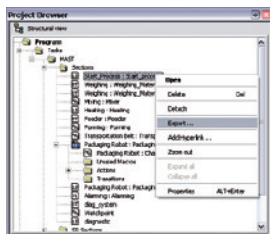

Data export shortcut menu

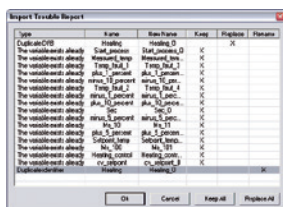

Data import wizard

Application converters

The EcoStruxure Control Expert integrated conversion tools can be used to convert applications created with ModSoft, ProWorX, Concept, and PL7 programming software to EcoStruxure Control Expert applications.

Concept/EcoStruxure Control Expert converter (Quantum and Momentum PACs)

This conversion is performed with a Concept application V2.5 or later (it can also be performed in V2.11 or later, but only after an update to V2.5). In order to perform the conversion, the application should be exported to an ASCII file in Concept. The export file is converted to a EcoStruxure Control Expert source file automatically. This file is then analyzed by EcoStruxure Control Expert. At the end of the procedure, a conversion report is generated and an output window displays any detected conversion error(s) and provides direct access to the part of the program to be modified.

The Concept application converter converts the application to EcoStruxure Control Expert, but does not guarantee that it will operate correctly in real time. It is therefore essential to test or debug all converted applications.

PL7/EcoStruxure Control Expert converter (Premium PAC and Atrium slot PAC)

This conversion is performed with a PL7 application V4 or later (Premium PAC or Atrium slot PAC). In order to perform the conversion, the source file (complete application or user function block) should be exported to PL7. The conversion procedure is similar to that of the Concept conversion described above.

Note: Applications created with Concept, Modsoft, and ProWORX can be converted to LL984. Please contact our Customer Care Center.

Unity M580 Application Converter (UMAC)

The conversion from Unity Quantum and Unity Premium applications to Unity M580 applications is performed with UMAC (V3.1.7). UMAC is a standalone software tool that can be installed on a Windows PC. The complete conversion process relies on the use of EcoStruxure Control Expert. UMAC is available in two sizes: Lite and Standard. UMAC Lite is free and downloadable from our website www.se.com. UMAC Lite allows the existing configuration to be retained while UMAC Standard adapts the code to Modicon M580.



Unity M580 Application Converter tool

Operating system update utilities

The OS-Loader software is designed for updating operating systems on Premium and Quantum platforms. It is supplied with EcoStruxure Control Expert software. It is used to upgrade EcoStruxure Control Expert processors and modules as well as to upgrade PL7 or Concept processors and modules to make them compatible with EcoStruxure Control Expert.

OS-Loader software supports:

- Premium processors
- Quantum processors
- Ethernet communication modules
- EtherNet/IP communication modules

The operating system updates are performed as follows:

- Uni-Telway RS 485 terminal link for Premium processors
- Modbus or Modbus Plus terminal link for Quantum processors
- Ethernet TCP/IP network for integrated Ethernet port on Premium processors and Premium and Quantum Ethernet modules

Note: For Modicon M340, M580, and Momentum this service is provided by Unity Loader (see page 2/8).

Online modification of the configuration (CCOTF)

This function, also called Change Configuration On The Fly (CCOTF), is used to modify the Modicon M580 or Modicon Quantum configuration online (application in RUN mode):

- Addition or removal of discrete or analog I/O modules
- Modification of configuration parameters of discrete or analog I/O modules (already present or newly installed)

On Quantum, the CCOTF function is supported by standalone processors for the three types of I/O architecture (local, RIO, DIO) using version 5 of EcoStruxure Control Expert, and for Hot Standby processors using version 4.1 or higher of EcoStruxure Control Expert. The CCOTF function should first be validated in the EcoStruxure Control Expert configuration screen. A confirmation screen appears when the configuration has been modified online.

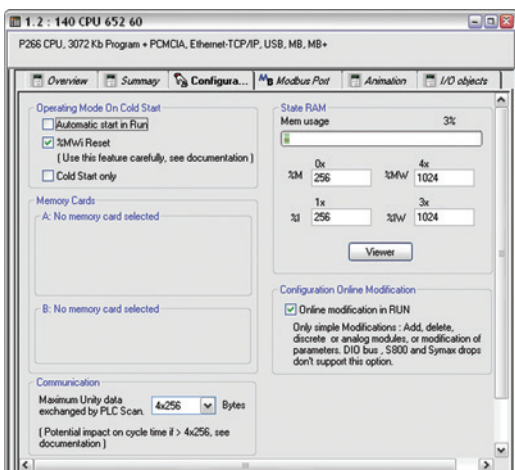

Configuration screen

Software

EcoStruxure Control Expert

Small/Large/Extra Large/Extra Large

with Topology Manager and M580 Safety

Programmable process control

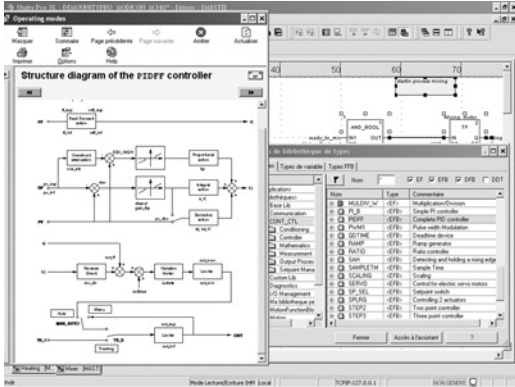

CONT_CTL, programmable process control integrated in EcoStruxure Control Expert

Process control in machines

EcoStruxure Control Expert contains **CONT_CTL**, a library of 36 function blocks used to create control loops for machine control.

The requirements for closed loop control functions in machines are adequately met by Modicon M340, Modicon M580, Modicon M580 Safety, Modicon Momentum, Premium, and Quantum platforms thanks to the wealth of functions in the library and the flexibility with which function blocks can be linked together through programming. This solution therefore avoids the need for external controllers and simplifies the overall control architecture of the machine, as well as its design, rollout, and operation.

The EFs or EFBs can be used in any of the EcoStruxure Control Expert languages (LD, ST, IL, and FBD). FBD is particularly suitable for accessing control processing operations in EcoStruxure Control Expert through its wizard for entering and viewing parameters and function block variables.

CONT_CTL library functions

The library consists of six function families:

- input data conditioning
- controllers
- mathematical functions
- process value processing
- output value processing
- setpoint management

Input data conditioning

DTIME	Pure time delay
INTEGRATOR	Integrator with limiting
LAG_FILTER	First order time lag
LDLG	Lead/lag function with smoothing
LEAD	Lead function with smoothing
MFLOW	Mass flow calculation based on the measurement of differential pressure or flow speed with pressure and temperature compensation
QDTIME	Dead time term
SCALING	Scaling
TOTALIZER	Integrator (typically of flow) until a limit (typically a volume) is reached, with automatic reset
VEL_LIM	Velocity limiter, with manipulated variable limiting

Controllers

PI_B	Basic PI controller: PI algorithm with a mixed structure (series/parallel)
PIDFF	Complete PID controller: PID algorithm with a parallel or mixed structure (series/parallel)
AUTOTUNE	Automatic tuner setting for the PIDFF (complete PID) controller or the PI_B (simple PI) controller <ul style="list-style-type: none"> □ Identification using Ziegler Nichols type method □ Modeling based on first-order process □ Building of control parameters with criterion for prioritizing either the reaction time to disturbance (dynamic) or the stability of the process
IMC	Model-based controller. The model is a first-order model with delay. This corrector is useful: <ul style="list-style-type: none"> □ When there are serious delays compared with the main time constant of the process; this scenario cannot be satisfactorily resolved by standard PID process control. □ For regulating a non-linear process IMC can handle any stable aperiodic process of any order.
SAMPLETM	Control of controller startup and sampling
STEP2	Simple two-position controller
STEP3	Three-position controller for temperature regulation

Mathematical functions

COMP_DB	Comparison of two values, with dead zone and hysteresis
K_SQRT	Square root, with weighting and threshold, useful for linearization of flow measurements
MULDIV_W	Weighted multiplication/division of 3 numerical values
SUM_W	Weighted summing of 3 numerical values

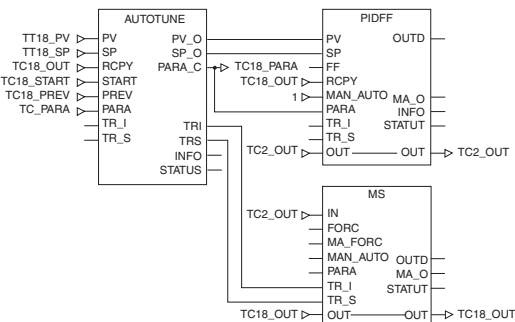

Example: PID controller with MS manual control

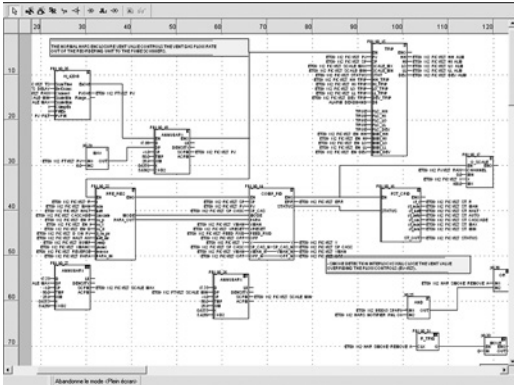

Programming in EcoStruxure Control Expert in offline mode

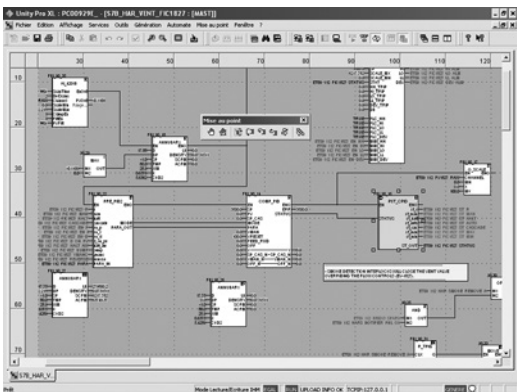

Programming in online mode

Process control in machines (continued)

CONT_CTL library functions (continued)

Process value processing

AVGMV	Moving average with fixed number of samples (50 max.)
AVGMV_K	Moving average with constant correction factor, 10,000 samples max.
DEAD_ZONE	Dead zone
LOOKUP_TABLE1	Linearization of characteristic curves using first-order interpolation
SAH	Detection of a rising edge
HYST_XXX	Detection of high threshold with hysteresis (1)
INDLIM_XXX	Detection of high and low thresholds with hysteresis (1)

Output value processing

MS	Manual control of an output
MS_DB	Manual control of an output with dead zone
PWM1	Control via pulse width modulation
SERVO	Control for servo motors
SPLRG	Control of two Split Range actuators

Setpoint management

RAMP	Ramp generator, with separate ascending and descending ramps
RATIO	Ratio controller
SP_SEL	Selection of setpoint value: local (operator) or remote (processing)

Setting up process control function blocks

Based on the sequencing of function blocks, the FBD language integrated in EcoStruxure Control Expert is a programming language particularly suitable for building control loops.

Designers can use FBD to easily associate blocks from the CONT_CTL library with their own DFBs written in EcoStruxure Control Expert's ST, IL, or LD language, or in C language.

Debugging, operation

All EcoStruxure Control Expert standard debugging services (see page 1/14) are available. In particular, the PLC simulator can be used to check correct execution of processing offline.

Compatibility

The CONT_CTL control function block library is available in all versions of EcoStruxure Control Expert. It is compatible with processors in the Modicon M340, Modicon M580, Modicon M580 Safety, Modicon Momentum, Premium, and Quantum ranges.

Optional specialized libraries

The CONT_CTL control function block library can be supplemented with optional specialized libraries to meet specific needs such as predictive control, fuzzy logic controller, HVAC, and mass flow calculation (see page 2/18).

Resources

The technical documentation provides many examples of how to set up programmable process control function blocks in FBD, LD, IL, and ST languages.

The techniques for adjusting process control loops are described in the EcoStruxure Control Expert online help and also in the documentation available at www.se.com.

(1) XXX according to the type of variable: DINT, INT, UINT, UDINT, REAL

Software

EcoStruxure Control Expert Small/Large/Extra Large/Extra Large with Topology Manager and M580 Safety

Communication drivers

The most commonly used communication drivers for Modicon M340, M580, M580S, Momentum, Premium, and Quantum platforms are installed at the same time as the EcoStruxure Control Expert software.

EcoStruxure Control Expert also includes the following drivers, which can be installed as required (1):

Protocol - Hardware	Windows® 7 32-bit and 64-bit editions	Windows® 10 32-bit and 64-bit editions
Fip adaptor - CUSBFIP		
Modbus Serial - COM port		
PCIway - Atrium TPCI57 PCI card		
Uni-Telway - COM port		
USB for high end PLC		
XIP - XWay on TCP/IP		

Driver available Driver not available

Upgrade kits for Concept, PL7 Pro, and ProWORX software

The Concept, PL7 Pro, and ProWORX upgrade kits allow users who already have one of these programs from the installed base, and who have a current subscription, to obtain EcoStruxure Control Expert version V4.1 software at a reduced price.

These upgrades are only available for licenses of the same type (e.g. from Concept XL group license to EcoStruxure Control Expert Extra Large group license).

EcoStruxure Control Expert update (2)

Customers are notified automatically when a new EcoStruxure Control Expert update becomes available. They can then access the software update manager directly, download the update, and install it locally on their workstation.

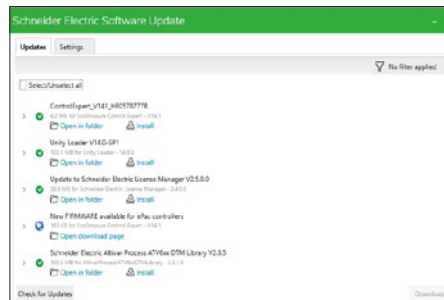

How-to tutorials

The EcoStruxure Control Expert has a dedicated YouTube channel showcasing videos that help you easily navigate and work with the software. It includes videos on topics like configuration, installation, testing, and software features. To explore more, click on the following link:

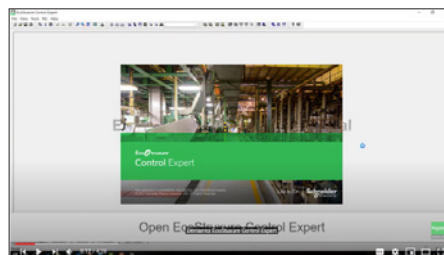

(1) Also available separately under reference **TLXCDDR20M**.

(2) EcoStruxure Control Expert requires **NET Framework 3.5** and **NET Framework 4.5.2**.

Note: The latest firmware versions can be downloaded from our website www.se.com.

Software

EcoStruxure Control Expert
Small/Large/Extra Large/Extra Large
with Topology Manager and M580 Safety

1

Univ...548_RPSPH20001



EcoStruxure Control Expert

EcoStruxure Control Expert licenses**Package and license can be ordered separately**

A license is mandatory to run EcoStruxure Control Expert (after expiration of trial period), while a DVD package is optional: installation files can be downloaded from www.se.com.

Licenses are delivered separately and are available in paper format or digital email format (delivered by email).

Unique package

The package is now unique for all sizes (Small, Large, Extra Large, Extra Large Safety, and Extra Large Topology Manager).

Licenses are available in different sizes:

- EcoStruxure Control Expert Small (see [page 1/24](#))
- EcoStruxure Control Expert Large (see [page 1/25](#))
- EcoStruxure Control Expert Extra Large (see [page 1/26](#))
- EcoStruxure Control Expert Extra Large with Topology Manager and Safety (see [page 1/28](#))
- EcoStruxure Control Expert Extra Large Topology Manager add-on (see [page 1/29](#))
- EcoStruxure Control Expert Large and Extra Large M580 Safety add-on (see [page 1/30](#))

License portability

The licenses are available as:

- Node-locked licenses that are locked to the computer where EcoStruxure Control Expert is running. They are compatible with digitized environments like virtual machine for desktop or server operating system.
- Floating licenses that are easily shared across the owner's company local network to optimize license occupancy. They are compatible with digitized environments like virtual machine, VMs server, remote IT architecture, etc.

EcoStruxure Control Expert with Topology Manager

Topology Manager is available as:

- An add-on license that can be added to an XL license (see [page 1/29](#))
- Directly with a bundle license (EcoStruxure Control Expert XL with Topology Manager and M580 Safety) (see [page 1/28](#))

EcoStruxure Control Expert with M580 Safety

M580 Safety is available as:

- An add-on license that can be added to an XL or L license (see [page 1/30](#))
- Directly with a bundle license (EcoStruxure Control Expert XL with Topology Manager and M580 Safety) (see [page 1/28](#))

Composition and Windows OS compatibility

EcoStruxure Control Expert multilingual software packages are compatible with Windows 10 (64-bit) and Windows Server 2019 operating systems.

The package comprises:

- EcoStruxure Control Expert V15 DVD in six languages (English, French, German, Italian, Spanish, and Chinese)
- Converters for converting applications created with Concept and PL7
- PLC simulator

Cables for connecting the processor to the programming PC need to be ordered separately.

Software

EcoStruxure Control Expert

Small/Large/Extra Large reference structure

EcoStruxure Control Expert licenses (continued)

EcoStruxure Control Expert license reference structure

To order a EcoStruxure Control Expert license, make up the reference as follows:

Example	CEX	SPU	C	Z	X	S	P	A	ZZ
Product code	EcoStruxure Control Expert	CEX							
Product attributes	Service Pack Base	SPU							
	Upgrade Number of Seats (for example, XL Single to Group)	UPN							
	Upgrade Size (for example, from L to XL)	UPG							
	Update Version (for example, from V14 to V15)	UPD							
	M580 Safety add-on	ADS							
	Update for M580 Safety add-on	UAS							
	Topology Manager add-on	ADM							
	Bundle for XL + M580 Safety + Topology Manager	SPM							
	Upgrade Bundle Node-locked license to Floating license	UMF							
	Upgrade Bundle (for example, from V14 to V15)	UMN/ UMD							
	System Integrator	SYS							
License type	Full Package		C						
	Unlimited Activation		F						
Service type	N/A (always)			Z					
Size	Small					S			
	Large					L			
	Extra Large					X			
	Small to Large					F			
	Large to Extra Large					K			
Seats	Single (1 user)					S			
	Group (3 users)					G			
	Team (10 users)					T			
	Entity (100 users)					E			
Duration	Permanent (always)						P		
Portability, Delivery	Node-locked, Email							A	
	Floating, Email							B	
	Node-locked, Paper							M	
	Floating, Paper							T	
Version	N/A (always)								ZZ

Note: ADM, SPM, UMF, UMN, and UMD options are available in Q1 2022 .

Software

EcoStruxure Control Expert Small

1

Univ...548_RFSPH20001



EcoStruxure Control Expert

EcoStruxure Control Expert Small software

For Modicon M340: **All models**
 For Modicon Momentum: **171CBU78090/98090/98091**
 For distributed I/O: **Modicon ETB, TM7, OTB, STB, Momentum**

EcoStruxure Control Expert Small license (SPU) (1) (2)

Description	Seat type	Reference
Node-locked Paper license		
EcoStruxure Control Expert Small	Single (1 user)	CEXSPUCZSSPMZZ
	Group (3 users)	CEXSPUCZSGPMZZ
	Team (10 users)	CEXSPUCZSTPMZZ
Node-locked Email license		
EcoStruxure Control Expert Small	Single (1 user)	CEXSPUCZSSPAZZ
	Group (3 users)	CEXSPUCZSGPAZZ
	Team (10 users)	CEXSPUCZSTPAZZ

EcoStruxure Control Expert Small license update (UPD)

Description	Seat type	Reference
Node-locked Paper license		
EcoStruxure Control Expert Small update	Single (1 user)	CEXUPDCZSSPMZZ
	Group (3 users)	CEXUPDCZSGPMZZ
	Team (10 users)	CEXUPDCZSTPMZZ
Node-locked Email license		
EcoStruxure Control Expert Small update	Single (1 user)	CEXUPDCZSSPAZZ
	Group (3 users)	CEXUPDCZSGPAZZ
	Team (10 users)	CEXUPDCZSTPAZZ

EcoStruxure Control Expert Small seat upgrade (UPN)

From	To	Reference
Node-locked Paper license		
Single (1 users)	Group (3 users)	CEXUPNCZSGPMZZ
Group (3 users)	Team (10 users)	CEXUPNCZSTPMZZ
Node-locked Email license		
Single (1 users)	Group (3 users)	CEXUPNCZSGPAZZ
Group (3 users)	Team (10 users)	CEXUPNCZSTPAZZ

(1) For compatibility of EcoStruxure Control Expert software/automation platforms and distributed I/O, refer to the selection guide on [page 1/2](#) .
 (2) Renewals for EcoStruxure Control Expert new versions are possible .Please contact our Customer Care Center for more information .

Software

EcoStruxure Control Expert Large

Unit_543_RFSPH20001



EcoStruxure Control Expert

EcoStruxure Control Expert Large software

For Modicon M340: **All models**
 For Modicon M580: **BMEH5820/BMEP5810/5820/5830**
 For Modicon Momentum: **171CBU78090/98090/98091**
 For Modicon Premium: **TSX571e...4e**
 For Modicon Quantum: **140CPU31110/43412U/53414U**
 For distributed I/O: **Modicon ETB, TM7, OTB, STB, Momentum**

EcoStruxure Control Expert Large license (SPU) (1) (2)

Description	Seat type	Reference
Node-locked Paper license		
EcoStruxure Control Expert Large	Single (1 user)	CEXSPUCZLSPMZZ
	Group (3 users)	CEXSPUCZLGPMZZ
	Team (10 users)	CEXSPUCZLTPMZZ

Node-locked Email license

EcoStruxure Control Expert Large	Single (1 users)	CEXSPUCZLSPAZZ
	Group (3 users)	CEXSPUCZLGPAAZ
	Team (10 users)	CEXSPUCZLTPAAZ

EcoStruxure Control Expert Large license update (UPD)

Description	Seat type	Reference
Node-locked Paper license		
EcoStruxure Control Expert Large update	Single (1 user)	CEXUPDCZLSPMZZ
	Group (3 users)	CEXUPDCZLGPMZZ
	Team (10 users)	CEXUPDCZLTPMZZ

Node-locked Email license

EcoStruxure Control Expert Large update	Single (1 user)	CEXUPDCZLSPAZZ
	Group (3 users)	CEXUPDCZLGPAAZ
	Team (10 users)	CEXUPDCZLTPAAZ

EcoStruxure Control Expert Large seat upgrade (UPN)

From	To	Reference
Node-locked Paper license		
Single (1 user)	Group (3 users)	CEXUPNCZLGPMZZ
Group (3 users)	Team (10 users)	CEXUPNCZLTPMZZ

Node-locked Email license

Single (1 user)	Group (3 users)	CEXUPNCZLGPAAZ
Group (3 users)	Team (10 users)	CEXUPNCZLTPAAZ

EcoStruxure Control Expert Small to Large size upgrade (UPG)

From	To	Reference
Node-locked Paper license		
Small Single (1 user)	Large Single (1 user)	CEXUPGCZLSPMZZ
Small Group (3 users)	Large Group (3 users)	CEXUPGCZLGPMZZ
Small Team (10 users)	Large Team (10 users)	CEXUPGCZLTPMZZ

Node-locked Email license

Small Single (1 user)	Large Single (1 user)	CEXUPGCZLSPAZZ
Small Group (3 users)	Large Group (3 users)	CEXUPGCZLGPAAZ
Small Team (10 users)	Large Team (10 users)	CEXUPGCZLTPAAZ

(1) For compatibility of EcoStruxure Control Expert software/automation platforms and distributed I/O, refer to the selection guide on [page 1/2](#).

(2) Renewals for EcoStruxure Control Expert new versions are possible. Please contact our Customer Care Center for more information.

Software

EcoStruxure Control Expert Extra Large

1

Univ...548_RFSHP20001



EcoStruxure Control Expert

EcoStruxure Control Expert Extra Large software

For Modicon M340: **All models**
 For Modicon M580: **All models**
 For Modicon Momentum: **171CBU78090/98090/98091**
 For Modicon Premium: **TSX571●...6●**
 For Modicon Quantum: **140CPU31110/43412U/53414U/65150/65160/65260/67160/67260/67261**
 For distributed I/O: **Modicon ETB, TM7, OTB, STB, Momentum**

EcoStruxure Control Expert Extra Large license (SPU) (1) (2)

Description	Seat type	Reference
Node-locked Paper license		
EcoStruxure Control Expert Extra Large	Single (1 user)	CEXSPUCZXSPMZZ
	Group (3 users)	CEXSPUCZXGPMZZ
	Team (10 users)	CEXSPUCZXTPMZZ
	Entity (100 users)	CEXSPUCZXEPMZZ

Floating Paper license

EcoStruxure Control Expert Extra Large	Group (3 users)	CEXSPUCZXGPTZZ
	Team (10 users)	CEXSPUCZXTPZZ
	Entity (100 users)	CEXSPUCZXEPZZ

Node-locked Email license

EcoStruxure Control Expert Extra Large	Single (1 user)	CEXSPUCZXSPAZZ
	Group (3 users)	CEXSPUCZXGPAZZ
	Team (10 users)	CEXSPUCZXTPAZZ
	Entity (100 users)	CEXSPUCZXEPAZZ

Floating Email license

EcoStruxure Control Expert Extra Large	Group (3 users)	CEXSPUCZXGPBZZ
	Team (10 users)	CEXSPUCZXTPBZZ
	Entity (100 users)	CEXSPUCZXEPBZZ

EcoStruxure Control Expert Extra Large license update (UPD)

Description	Seat type	Reference
Node-locked Paper license		
EcoStruxure Control Expert Extra Large update	Single (1 user)	CEXUPDCZXSPMZZ
	Group (3 users)	CEXUPDCZXGPMZZ
	Team (10 users)	CEXUPDCZXTPMZZ
	Entity (100 users)	CEXUPDCZXEPMZZ

Floating Paper license

EcoStruxure Control Expert Extra Large update	Group (3 users)	CEXUPDCZXGPTZZ
	Team (10 users)	CEXUPDCZXTPZZ
	Entity (100 users)	CEXUPDCZXEPZZ

Node-locked Email license

EcoStruxure Control Expert Extra Large update	Single (1 user)	CEXUPDCZXSPAZZ
	Group (3 users)	CEXUPDCZXGPAZZ
	Team (10 users)	CEXUPDCZXTPAZZ
	Entity (100 users)	CEXUPDCZXEPAZZ

Floating Email license

EcoStruxure Control Expert Extra Large update	Group (3 users)	CEXUPDCZXGPBZZ
	Team (10 users)	CEXUPDCZXTPBZZ
	Entity (100 users)	CEXUPDCZXEPBZZ

(1) For compatibility of EcoStruxure Control Expert software/automation platforms and distributed I/O, refer to EcoStruxure Control Expert Pro Extra Large in the selection guide on page 1/4.

(2) Renewals for EcoStruxure Control Expert new versions are possible. Please contact our Customer Care Center for more information.

Software

EcoStruxure Control Expert

Extra Large

Unit_548_RFSPH20001



EcoStruxure Control Expert

EcoStruxure Control Expert Extra Large software (continued)

For Modicon M340: **All models**
 For Modicon M580: **All models**
 For Modicon Momentum: **171CBU78090/98090/98091**
 For Modicon Premium: **TSX571●...6●**
 For Modicon Quantum: **140CPU31110/43412U/53414U/65150/65160/65260/67160/67260/67261**
 For distributed I/O: **Modicon ETB, TM7, OTB, STB, Momentum**

EcoStruxure Control Expert Extra Large seat upgrade (UPN)

From	To	Reference
Node-locked Paper license		
Single (1 user)	Group (3 users)	CEXUPNCZXGPMZZ
Group (3 users)	Team (10 users)	CEXUPNCZXTPMZZ
Team (10 users)	Entity (100 users)	CEXUPNCZXEPMZZ
Floating Paper license		
Group (3 users)	Team (10 users)	CEXUPNCZXTPZZ
Team (10 users)	Entity (100 users)	CEXUPNCZXEPZZ
Node-locked Email license		
Single (1 user)	Group (3 users)	CEXUPNCZXGPAZZ
Group (3 users)	Team (10 users)	CEXUPNCZXTPAZZ
Team (10 users)	Entity (100 users)	CEXUPNCZXEPAZZ
Floating Email license		
Group (3 users)	Team (10 users)	CEXUPNCZXTPBZZ
Team (10 users)	Entity (100 users)	CEXUPNCZXEPBZZ

EcoStruxure Control Expert Large to Extra Large Size upgrade (UPG)

From	To	Reference
Node-locked Paper license		
Large Single (1 user)	Extral Large Single (1 user)	CEXUPGCZXSPMZZ
Large Group (3 users)	Extra Large Group (3 users)	CEXUPGCZXGPMZZ
Large Team (10 users)	Extra Large Team (10 users)	CEXUPGCZXTPMZZ
Node-locked Email license		
Large Single (1 user)	Extral Large Single (1 user)	CEXUPGCZXSPAZZ
Large Group (3 users)	Extra Large Group (3 users)	CEXUPGCZXGPAZZ
Large Team (10 users)	Extra Large Team (10 users)	CEXUPGCZXTPAZZ

EcoStruxure Control Expert Extra Large Node-locked to Floating upgrade (UPG)

From	To	Reference
Paper license		
Group Node-locked (3 users)	Group Floating (3 users)	CEXUPGCZXGPTZZ
Team Node-locked (10 users)	Team Floating (10 users)	CEXUPGCZXTPZZ
Entity Node-locked (100 users)	Entity Floating (100 users)	CEXUPGCZXEPZZ
Email license		
Group Node-locked (3 users)	Group Floating (3 users)	CEXUPGCZXGPBZZ
Team Node-locked (10 users)	Team Floating (10 users)	CEXUPGCZXTPBZZ
Entity Node-locked (100 users)	Entity Floating (100 users)	CEXUPGCZXEPBZZ

(1) For compatibility of EcoStruxure Control Expert software/automation platforms and distributed I/O, refer to EcoStruxure Control Expert Pro Extra Large in the selection guide on [page 1/4](#).

(2) Renewals for EcoStruxure Control Expert new versions are possible. Please contact our Customer Care Center for more information.



EcoStruxure Control Expert

EcoStruxure Control Expert Extra Large software with Topology Manager and M580 Safety

For Modicon M340: **All models**

For Modicon M580: **All models**

For Modicon M580 Safety: **All models**

For Modicon Momentum: **171CBU78090/98090/98091**

For Modicon Premium: **TSX571e...6e**

For Modicon Quantum: **140CPU31110/43412U/53414U/65150/65160/65260/67160/67260/67261**

For distributed I/O: **Modicon ETB, TM7, OTB, STB, Momentum**

EcoStruxure Control Expert Extra Large with Topology Manager and M580 Safety license (SPM) (1)

Description	Seat type	Reference
Node-locked Paper license		
EcoStruxure Control Expert Extra Large with Topology Manager and M580 Safety	Single (1 user)	CEXSPMCZXSPMZZ
	Group (3 users)	CEXSPMCZXGPMZZ
	Team (10 users)	CEXSPMCZXTPMZZ
	Entity (100 users)	CEXSPMCZXEPMZZ

Floating Paper license

EcoStruxure Control Expert Extra Large with Topology Manager and M580 Safety	Group (3 users)	CEXSPMCZXGPTZZ
	Team (10 users)	CEXSPMCZXTPZZ
	Entity (100 users)	CEXSPMCZXEPZZ
	Education Entity (100 users)	CEXSPMEZXEPZZ

Node-locked Email license

EcoStruxure Control Expert Extra Large with Topology Manager and M580 Safety	Single (1 user)	CEXSPMCZXSPAZZ
	Group (3 users)	CEXSPMCZXGPAZZ
	Team (10 users)	CEXSPMCZXTPAZZ
	Entity (100 users)	CEXSPMCZXEPAZZ
	Corporate (unlimited users)	CEXSPMFZXSPAZZ

Floating Email license

EcoStruxure Control Expert Extra Large with Topology Manager and M580 Safety	Group (3 users)	CEXSPMCZXGPBZZ
	Team (10 users)	CEXSPMCZXTPBZZ
	Entity (100 users)	CEXSPMCZXEPBZZ
	Education Entity (100 users)	CEXSPMEZXEPBZZ

EcoStruxure Control Expert Extra Large with Topology Manager and M580 Safety update (UMD)

Description	Seat type	Reference
Node-locked Email license		
EcoStruxure Control Expert Extra Large with Topology Manager and M580 Safety	Corporate (unlimited users)	CEXUMDFZXSPAZZ
Floating Paper license		
EcoStruxure Control Expert Extra Large with Topology Manager and M580 Safety	Education Entity (100 users)	CEXUMDEZXEPZZ
Floating Email license		
EcoStruxure Control Expert Extra Large with Topology Manager and M580 Safety	Education Entity (100 users)	CEXUMDEZXEPBZZ

EcoStruxure Control Expert Extra Large with Topology Manager and M580 Safety seat upgrade (UMN) (1)

From	To	Reference
Node-locked Paper license		
Single (1 user)	Group (3 users)	CEXUMNCZXGPMZZ
Group (3 users)	Team (10 users)	CEXUMNCZXTPMZZ
Team (10 users)	Entity (100 users)	CEXUMNCZXEPMZZ
Floating Paper license		
Group (3 users)	Team (10 users)	CEXUMNCZXTPZZ
Team (10 users)	Entity (100 users)	CEXUMNCZXEPZZ

(1) Available Q1 2022

Software

EcoStruxure Control Expert Extra Large with Topology Manager and M580 Safety Topology Manager add-on

Univ_548_RFSHP20001



EcoStruxure Control Expert



EcoStruxure Control Expert Extra Large software with Topology Manager and M580 Safety (continued)

EcoStruxure Control Expert Extra Large with Topology Manager and M580 Safety seat upgrade (UMN) (1)

From	To	Reference
Node-locked Email license		
Single (1 user)	Group (3 users)	CEXUMNCZXGPAZZ
Group (3 users)	Team (10 users)	CEXUMNCZXTPAZZ
Team (10 users)	Entity (100 users)	CEXUMNCZXEPAAZ
Entity (100 users)	Corporate (unlimited users)	CEXUMNFZXSPAZZ
Floating Email license		
Group (3 users)	Team (10 users)	CEXUMNCZXTPBZZ
Team (10 users)	Entity (100 users)	CEXUMNCZXEPBZZ

EcoStruxure Control Expert Extra Large with Topology Manager and M580 Safety Node-locked to Floating (UMF) (1)

From	To	Reference
Paper license		
Group Node-locked (3 users)	Group Floating (3 users)	CEXUMFCZXGPTZZ
Team Node-locked (10 users)	Team Floating (10 users)	CEXUMFCZXTPTZZ
Entity Node-locked (100 users)	Entity Floating (100 users)	CEXUMFCZXEPZZ
Email license		
Group Node-locked (3 users)	Group Floating (3 users)	CEXUMFCZXGPBZZ
Team Node-locked (10 users)	Team Floating (10 users)	CEXUMFCZXTPBZZ
Entity Node-locked (100 users)	Entity Floating (100 users)	CEXUMFCZXEPBZZ

Topology Manager add-on for EcoStruxure Control Expert Extra Large software

For Modicon M340: **All models**
 For Modicon M580: **All models**
 For Modicon M580 Safety: **All models**
 For Modicon Momentum: **171CBU78090/98090/98091**
 For Modicon Premium: **TSX571e...6e**
 For Modicon Quantum: **140CPU31110/43412U/53414U/65150/65160/65260/67160/67260/67261**
 For distributed I/O: **Modicon ETB, TM7, OTB, STB, Momentum**

Topology Manager add-on for EcoStruxure Control Expert Extra Large license (ADM) (1)

Description	Seat type	Reference
Node-locked Paper license		
Topology Manager add-on for EcoStruxure Control Expert Extra Large	Single (1 user)	CEXADMCZZSPMZZ
	Group (3 users)	CEXADMCZZGPMZZ
	Team (10 users)	CEXADMCZZTPMZZ
	Entity (100 users)	CEXADMCZZEPMZZ
Floating Paper license		
Topology Manager add-on for EcoStruxure Control Expert Extra Large Floating	Group (3 users)	CEXADMCZZGPTZZ
	Team (10 user)	CEXADMCZZTPTZZ
	Enttiy (100 users)	CEXADMCZZEPTZZ
Node-locked Email license		
Topology Manager add-on software license for EcoStruxure Control Expert Extra Large software E-license	Single (1 user)	CEXADMCZZSPAZZ
	Group (3 users)	CEXADMCZZGPAZZ
	Team (10 users)	CEXADMCZZTPAAZ
	Entity (100 users)	CEXADMCZZEPAZZ
	Corporate (unlimited users)	CEXADMFZZSPAZZ
Floating Email license		
Topology Manager add-on for EcoStruxure Control Expert Extra Large	Group (3 users)	CEXADMCZZGPBZZ
	Team (10 users)	CEXADMCZZTPBZZ
	Enttiy (100 users)	CEXADMCZZEPBZZ

(1) Available Q1 2022

Software

EcoStruxure Control Expert

Large/Extra Large

M580 Safety add-on

1

Unity_544_RPSPH20001



EcoStruxure Control Expert

M580 Safety add-on for EcoStruxure Control Expert Large/Extra Large software

For Modicon M580 Safety: **All models**

License use examples

EcoStruxure Control Expert Extra Large with M580 Safety can now be managed in different ways:

- With an add-on license that can be added to an XL or L license (see below on this page)
- Directly with a bundle license (EcoStruxure Control Expert XL with M580 Safety) (see below on this page)

To manage BMEP582040S or BMEH582040S Safety CPUs, the following license can be used:

- **CEXSPUCZL●PMZZ** (EcoStruxure Control Expert Large) with **CEXADSCZZ●PMZZ** (M580 Safety add-on for L or XL single)

To manage all Modicon M580 Safety CPU models, the following license can be used:

- **CEXSPUCZX●PMZZ** (EcoStruxure Control Expert Large) with **CEXADSCZZ●PMZZ** (M580 Safety add-On for L or XL single)
- **CEXSPMCZX●PMZZ** (EcoStruxure Control Expert Large with Topology Manager and M580 Safety)

M580 Safety add-on for EcoStruxure Control Expert license (ADS)

Description	Seat type	Reference
Larg/Extra Large Node-locked Paper license		
M580 Safety add-on for EcoStruxure Control Expert Large or Extra Large	Single (1 user)	CEXADSCZZSPMZZ
	Group (3 users)	CEXADSCZZGPMZZ
	Team (10 users)	CEXADSCZZTPMZZ
	Entity (100 users)	CEXADSCZZEPMZZ
Extra Large Floating Paper license		
M580 Safety add-on for EcoStruxure Control Expert Extra Large	Group (3 users)	CEXADSCZZGPTZZ
	Team (10 users)	CEXADSCZZTPTZZ
	Entity (100 users)	CEXADSCZZEPTZZ
Large/Extra Large Node-locked Email license		
M580 Safety add-on for EcoStruxure Control Expert Large or Extra Large	Single (1 user)	CEXADSCZZSPAZZ
	Group (3 users)	CEXADSCZZGPAZZ
	Team (10 users)	CEXADSCZZTPAZZ
	Entity (100 users)	CEXADSCZZEPAZZ
Extra Large Floating Email license		
M580 Safety add-on for EcoStruxure Control Expert Extra Large	Group (3 users)	CEXADSCZZGPBZZ
	Team (10 users)	CEXADSCZZTPBZZ
	Entity (100 users)	CEXADSCZZEPBZZ

M580 Safety add-on for EcoStruxure Control Expert Large/Extra Large license update (UAS)

Description	Seat type	Reference
Node-locked Paper license		
M580 Safety add-on for EcoStruxure Control Expert Large or Extra Large update	Single (1 user)	CEXUASCZZSPMZZ
	Group (3 users)	CEXUASCZZGPMZZ
	Team (10 users)	CEXUASCZZTPMZZ
	Entity (100 users)	CEXUASCZZEPMZZ
Node-locked Email license		
M580 Safety add-on for EcoStruxure Control Expert Large or Extra Large update	Single (1 user)	CEXUASCZZSPAZZ
	Group (3 users)	CEXUASCZZGPAZZ
	Team (10 users)	CEXUASCZZTPAZZ
	Entity (100 users)	CEXUASCZZEPAZZ

(1) For compatibility of EcoStruxure Control Expert software/automation platforms and distributed I/O, refer to EcoStruxure Control Expert Extra Large in the selection guide on page 1/4.

(2) Renewals for EcoStruxure Control Expert new versions are possible. Please contact our Customer Care Center for more information.



Accessories for connecting to PC programming terminal

Description	Use		Length m/ft	Reference	Weight kg/lb
	From processor port	To PC port			
PC terminal connection cables (PC to PAC) (1)	USB mini B port	USB port	1.8/ 5.91	BMXXCAUSBH018	0.065/ 0.143
	BMXP341000/20●0/20●02				
	BMEP58●●●●●		4.5/ 14.8	BMXXCAUSBH045	0.110/ 0.243
	USB port	USB port	3.3/ 10.8	UNYXCAUSB033	–
	Premium TSX575●/6● Quantum 140CPU6●1				
	Modbus port, RJ45 connector	RJ45 connector	3/ 9.84	110XCA28202	–
	Quantum 140CPU6●1				
PC terminal connection cables (PC SUB-D to Modicon STB I/O)	HE13 connector Modicon	RS-232D (2)	2/ 6.56	STBXCA4002	0.210/ 0.463
	STB I/O network interface module (NIM)	(9-way SUB-D connector)			
USB/SUB-D adaptor (PC USB to Modicon STB I/O)	HE13 connector Modicon	USB port (3)	–	SR2CBL06	0.185/ 0.408
	STB I/O network interface module (NIM) with STBXCA4002 cable (3)				

(1) The [490NTW00002](#) and [490NTW00002U](#) RJ45 ConneXium cables (2 m/6.56ft) can be used to connect the PC to the SERVICE port of M580 CPUs or X80 drop. Please consult our website www.se.com

(2) Use the [SR2CBL06](#) cable for connection on a USB port (3).

(3) Adapter equipped with a USB connector (PC side) and a 9-way SUB-D connector (STBXCA4002 cable side); requires the [STBXCA4002](#) cable (9-way SUB-D/HE 13) for connection to the HE13 connector on the Modicon STB NIM.

2 - EcoStruxure Control Expert Companion software

EcoStruxure Automation Device Maintenance

- Presentation [page 2/2](#)
- References [page 2/3](#)

EFB Toolkit software

- Presentation, setup [page 2/4](#)
- References [page 2/5](#)

Unity DIF software

- Presentation, setup [page 2/6](#)
- References [page 2/7](#)

Unity Loader software

- Presentation [page 2/8](#)
- References [page 2/9](#)

Asset Link

- Presentation, features [page 2/10](#)
- References [page 2/13](#)

Modicon Communication Server

- Presentation, features [page 2/14](#)
- References [page 2/15](#)

EcoStruxure Control Expert libraries

- **General Purpose Library** [page 2/16](#)
 - Presentation, features [page 2/16](#)
 - References [page 2/17](#)
- **Application-specific libraries** [page 2/18](#)
 - Presentation [page 2/18](#)
 - References [page 2/19](#)

Software

EcoStruxure Control Expert

EcoStruxure Automation Device Maintenance

Firmware upgrade tool

2



EcoStruxure Automation Device Maintenance

Presentation

EcoStruxure™ Automation Device Maintenance allows you to upgrade the firmware on multiple devices simultaneously. The devices can be discovered automatically or can be added manually if automatic device discovery is not supported or switched off in the device.

The supported device discovery methods are:

- Modbus function code 43 (Read Device Identification)
- DPWS (Device Profile for Web Services)

EcoStruxure Automation Device Maintenance supports the following features:

- Automatic device discovery
- Manual device identification
- Certificate management
- Firmware update for multiple devices simultaneously
- IP address management

Software graphic interface

The interface is easy to use and provides the following main views for different operations:

- **Main device/loading:** After initial start-up, EcoStruxure Automation Device Maintenance displays a view with the details of the devices known by the tool. It will also allow you to upgrade firmware on multiple devices.
- **Add device:** It is possible to add a new device as an unidentified device if the device cannot be discovered automatically by EcoStruxure Automation Device Maintenance because either the device does not support discovery, or the device discovery feature is switched off.
- **Data package:** The package repository displays the firmware packages available in the tool. Selecting a certain package from the list will display the related information of that package like category, product, release notes, and location.
- **Configuring settings:** The Settings page allows you to configure discovery mode, communication settings, package settings, logs, manage device certificates, and select the desired language.
- **Error and Warning window:** The details of the detected errors can be displayed in a cumulative log window. The error log provides the details to rectify the detected error related to the selected device.
- **Project:** The Project feature allows you to create a new EcoStruxure Automation Device Maintenance project, and open and save existing ones.

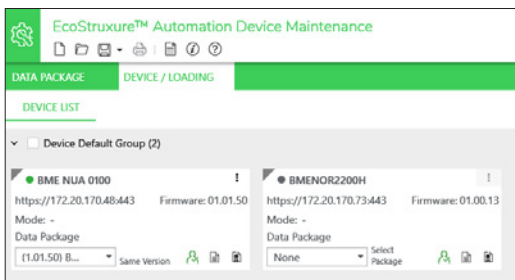

Thumbnail view of devices for easy handling

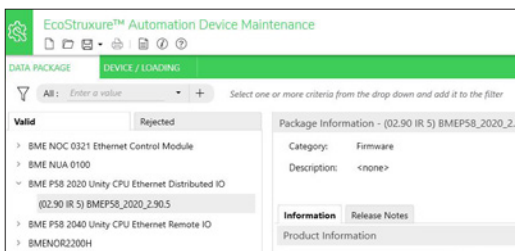

Data package

Modicon M340 PAC and BMXRMS●●8MFP memory card only

The EcoStruxure Automation Device Maintenance tool can download the firmware (controller or module) onto a flash memory card (BMXRMS●●8MFP only) plugged into the PAC CPU. This firmware download can then be used to update a remote Modicon M340 PAC.

In future versions, the project files will also be downloadable along with the firmware.

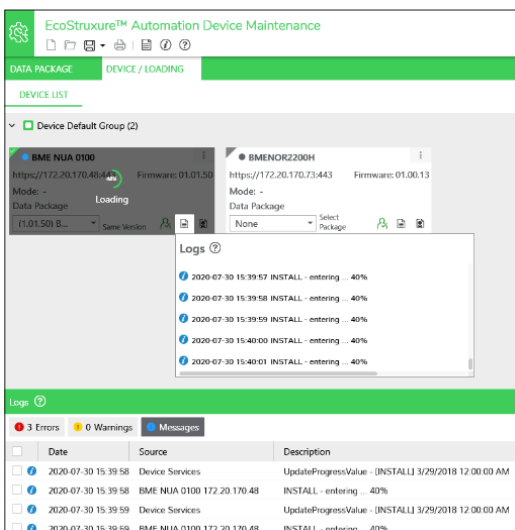

Performing firmware update on a device

PC-to-PAC communication

EcoStruxure Automation Device Maintenance supports the following PC-to-PAC communication:

- Modicon M580, Modicon M340, or Momentum Unity PACs or Modicon X80, Modicon M580, and Modicon M340 modules: Communication via Ethernet and USB ports, transfer of project components and firmware.

Reference	Type of module	Direct		Indirect
		Ethernet port	USB port	Rack/slot via X-bus
BMEP58000	Modicon M580 Standard Standalone CPU	Supported	Supported	Not supported
BMEH58040	Modicon M580 Standard Redundant CPU	Supported	Supported	Not supported
BMEP58040S	Modicon M580 Safety Standalone CPU	Supported	Supported	Not supported
BMEH58040S	Modicon M580 Safety Redundant CPU	Supported	Supported	Not supported
BMXP34000	Modicon M340 CPU with Modbus	Supported	Supported	Not supported
BMXP342010	Modicon M340 CPU with CANopen	Supported	Supported	Not supported
BMXP342020	Modicon M340 CPU with Ethernet and Modbus	Supported	Supported	Not supported
BMXP342030	Modicon M340 CPU with Ethernet and CANopen	Supported	Supported	Not supported
171CBU78090	Modicon Momentum Unity CPU with Modbus	Supported	Supported	Not supported
171CBU9809	Modicon Momentum Unity CPU with Ethernet and Modbus	Supported	Supported	Not supported
BMXAMI/ART/AMO/AMM	Modicon X80 Analog I/O module	Not supported	Not supported	(1)
BMEAH0012	Modicon X80 Hart Analog I/O module	Supported via Ethernet port of CPU or Ethernet module	Not supported	Not supported
BMXEHC000	Modicon X80 Counter module	Not supported	Not supported	(2)
BMXERT1604T	Modicon X80 Time Stamping module	Not supported	Not supported	Not supported
BMXMSP0200	Modicon X80 Motion Control module	Not supported	Not supported	Not supported
PMESWT0100	Modicon X80 Partner (3) Weighing module	Supported	Supported	Not supported
BMXNOM0200	Modicon X80 Serial link module	Not supported	Not supported	Not supported
BMECXM0100	Modicon X80 CANopen Master module	Supported	Supported	Not supported
PMEPXM0100	Modicon X80 PROFIBUS DP/DPV1 Master module	Supported	Supported	Not supported
BMECRA31210	Modicon X80 Ethernet remote I/O drop adapter	Supported	Supported	Not supported
BMXCRA31210	Modicon X80 Ethernet remote I/O drop adapter	Supported	Supported	Not supported
BMENOC0301	Modicon M580 Ethernet module	Supported	Supported	Not supported
BMENUA0100	Modicon M580 OPC UA module	Not supported	Not supported	Not supported
BMENOR2200H	Modicon M580 Advanced RTU module	Supported via Ethernet port of CPU or Ethernet module	Not supported	Not supported
BMENOP0300	Modicon M580 IEC 61850 module	Supported	Supported	Not supported
BMXNOR0200H	Modicon M340 RTU module	Supported	Supported	Not supported
BMXNOE0100	Modicon M340 Ethernet Modbus/TCP module	Supported	Supported	Not supported
BMXNOC0401	Modicon M340 Ethernet Modbus/TCP and EtherNet/IP module	Supported	Supported	Not supported

Supported
 Supported via Ethernet port of CPU or Ethernet module
 Not supported

In future versions, the following communications will also be supported:

- Modicon Quantum EcoStruxure Control Expert PACs: Modbus communication, transfer of project components only
- Modicon Premium EcoStruxure Control Expert PACs: Unitelway communication, transfer of project components only

For Ethernet networks, EcoStruxure Automation Device Maintenance contains a network scanner that can be used to scan a range of network addresses. Once a recognized Modicon M340, M580, or Momentum Unity PAC has been selected, data transfer operations can be performed.

Cybersecurity

The following ports are used by the software:

- Modbus (via port 502)
- HTTP (via port 80)/HTTPs (via ports 443 and 8080)
- FTP (via ports 20, 21)
- DPWS (via port 3702)

References

Description	Type	Reference
EcoStruxure Automation Device Maintenance	Single license (1 station)	Software can be downloaded free of charge from www.se.com/download/EADM

(1) For BMXAMM, not supported if module is in main CPU rack .

(2) Not supported if module is in main CPU rack .

(3) Partner collaborating to Technology Partner Program (TPP) .For further details, see our website www.se.com .



EFB Toolkit

Presentation

EFB Toolkit software helps to develop EFs and EFBs in “C” programming language. As an option with EcoStruxure Control Expert, it can be used to extend the standard EcoStruxure Control Expert function blocks in order to increase functionality. This software comes with *Microsoft Visual Studio*, which can be used to debug the function blocks developed in the EcoStruxure Control Expert PLC simulator. EFB Toolkit also includes a service for creating and managing families of function blocks and integrating them in EcoStruxure Control Expert.

Setup

EFB Toolkit manages the whole process of developing EcoStruxure Control Expert function blocks:

- User-friendly graphical user interface with automatic file organization
- Powerful tools for testing and debugging
- Management of compatibilities and software versions of created functions
- Generation of executable files for subsequent installation of functions on different EcoStruxure Control Expert stations

Managing function block families

EFB Toolkit helps to create and manage function block families. The function blocks developed, also known as EFs/EFBs, are stored in families. It makes it possible to create an organized library of functions written in “C” language. Once created, these function block families are installed on the EcoStruxure Control Expert stations for the purpose of extending the standard EcoStruxure Control Expert libraries. Integration in EcoStruxure Control Expert can be executed from EFB Toolkit or via the tool for updating EcoStruxure Control Expert libraries, which allows these families to be distributed without the use of any other software.

Developing function blocks

The EFB Toolkit software allows the user to create a function block as follows:

- Declaration of the function block interface in the same way as for the DFBs in EcoStruxure Control Expert
- Definition of all data types needed (elementary, structures, tables)
- Support of public and private variables
- Generation of all files and the block “C” coding frame (the user only adds functionality to this frame)
- Granting access to numerous internal PAC services, such as the real-time clock, PAC variables and data, system words and math functions, including high-precision numerical processing in “double” format
- Structure of the function block family (compilation/link for all EcoStruxure Control Expert automation platforms)
- Provision of a debugging environment: the function blocks created can easily be debugged in *Microsoft Visual Studio* by downloading an EcoStruxure Control Expert application containing the function developed in the EcoStruxure Control Expert PLC simulator. The debugging functions in *Microsoft Visual Studio*, especially breakpoints, step-by-step operations, display of the code/data, and manipulation of the data can be accessed without restriction.
- Support for managing EcoStruxure Control Expert versions, important during the function block maintenance phase

Compatibility

EFB Toolkit is compatible with EcoStruxure Control Expert, Large and Extra Large. EFs and EFBs can be developed for Modicon Premium, Quantum, M340, M580, and Unity Momentum platforms.

The latest available EFB Toolkit version is V14:

- OS compatibility Windows® 7 (32-bit and 64-bit), Windows® 10 (32-bit and 64-bit)
- Generated libraries can be installed on EcoStruxure Control Expert

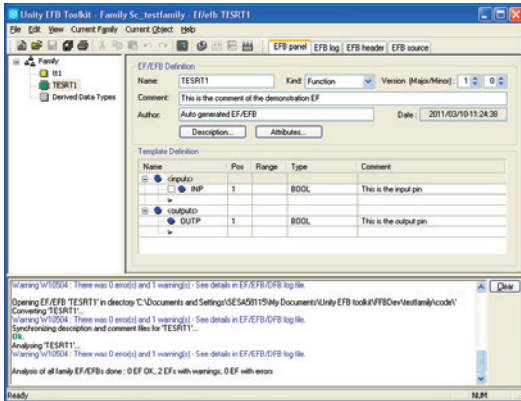

EFB Toolkit: Managing function block families

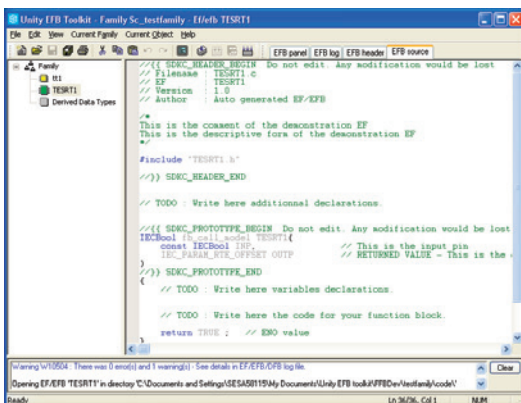

EFB Toolkit: Editor

References

EFB Toolkit and its documentation are supplied in electronic format on DVD-ROM in English and can be downloaded from our website www.se.com.

EFB Toolkit package includes:

- EFB Toolkit DVD
- GNU Compiler CD
- Microsoft Visual Studio DVD

Description	Type	Language	Reference
EFB Toolkit software	Single license (1 station)	English (software and electronic documentation)	UNYSPUZFUCD80



Unity DIF

Presentation

Unity DIF software helps to compare two EcoStruxure Control Expert application files and represents differences in a graphical format similar to EcoStruxure Control Expert graphics for consistency and better understanding. The differences are displayed graphically and textually based on the type of section chosen. Unity DIF improves productivity during the main life stages of a control system, mainly during development and debugging of applications and commissioning, operation, and maintenance of the installation.

Setup

Unity DIF compares two EcoStruxure Control Expert application files (XEF, ZEF, STU and STA) and detects anything ADDED, DELETED, and MODIFIED. The user interface and graphical representation of differences are similar to EcoStruxure Control Expert for consistency and ease of understanding the differences.

Unity DIF can be launched in several ways:

- From EcoStruxure Control Expert
- From the Windows Start menu
- From a command line interface

Unity DIF can provide differences for the following sections:

- PAC Configuration (Hardware and Network)
- Derived Data Types
- Derived FB Types
- Variables and FB Instance
- Motion
- Communication
- Programs
- Animation Table
- Operator Screen
- DTM Catalog
- Project Settings

The result of the comparison can be printed or saved in .pdf and .txt file formats.

Windows® OS Compatibility

Unity DIF is compatible with Windows 7 (32-bit and 64-bit), Windows 10 (32-bit and 64-bit), and Windows Server 2008 R2 (64-bit).

Comparison (1)

The base and compare files have to be selected by the user, and the results of the comparison will be displayed with respect to the base file as reference.

Before initiating comparison, the user can select their preference of required section for comparison.

Displaying results

Upon comparison, the section summary will be loaded with the complete list of differences. The user can navigate through the project browser window or using the F7 and F8 keys.

The differences will be highlighted in three different colors signifying Added, Deleted, or Modified types. Colors can be customized as per the user's preference. The detailed report can be generated through Print or can be saved for later reference.

Unity DIF also supports command line processing and .txt report generation for interfacing with Partner software.

(1) Comparison of STU and STA requires EcoStruxure Control Expert to be available .

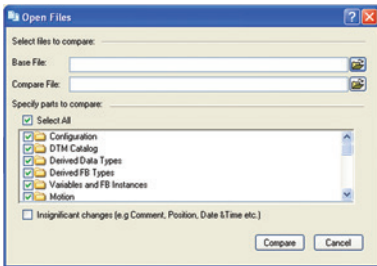

Selection of elements to compare

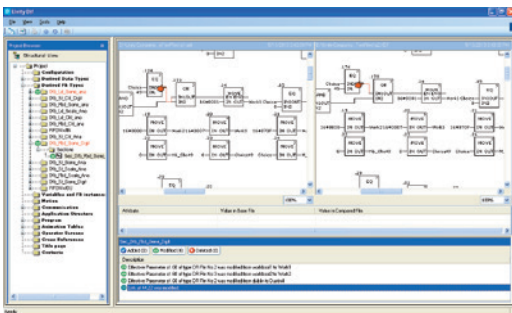

Displaying results

Software

EcoStruxure Control Expert

Unity DIF software

References

Unity DIF software is free and can be downloaded from our website www.se.com.

Compatibility: From Unity Pro V2.1 to EcoStruxure Control Expert V15 or later.

Description	Language	Type	Reference
Unity DIF software	English (software and electronic documentation)	Single license (1 station)	UNYDFXZZSPA80 (1)

(1) Available on our website www.se.com.



Unity Loader

Presentation

Unity Loader is companion software to EcoStruxure Control Expert and is used to perform maintenance operations on automation applications. Its easy setup and the small size of its executable make it a vital tool for updating EcoStruxure Control Expert projects without needing to use EcoStruxure Control Expert. It can also be used for updating the embedded software on Modicon M340, M580, M580S, or Momentum Unity PACs or on Modicon X80 I/O modules. It performs the following main functions:

- Transferring automation project components, such as the program and data, from the PC to the PAC or the PAC to the PC
- Transferring files and user web pages stored in the memory card of Modicon M340 PACs
- Transferring the firmware from the PC to Modicon M340, M580, M580S, or Momentum Unity PACs or to Modicon X80 I/O modules

Software graphic interface

The interface is easy to use and has four tabs for access to different operations:

- The **“Project”** tab manages the transfer of projects (program and data) between the PC and the PAC CPU. The software transfers the program (application file format: .stu; archive file format: .sta) and data (located and unlocated; data file format: .dat) of an EcoStruxure Control Expert project in both directions. The program and data files created by Unity Loader are compatible with EcoStruxure Control Expert. When it is connected to the PAC, Unity Loader displays the information associated with the data read in the PAC. This information is displayed on the PC for the selected files. The user decides which project elements will be transferred by a single command after validation of the required transfers.
 - *Modicon M340 PACs and BMXRMS●●8MFP memory card only:* The files and user web pages can be transferred from the memory card to the PC and vice versa.
 - *BMXNOE0110 with flash memory card only:* Web pages stored in the flash memory can be transferred from the module to the PC and vice versa.
- The **“Firmware”** tab can be used to update the firmware in the Modicon M340, M580, M580S, or Momentum Unity PACs or on Modicon X80 I/O modules. The screen displays the detailed content of the firmware versions existing in the module and on the PC. Firmware updating works in the same way as project transfers.
- The **“Options”** tabs is used to configure the working environment, especially the location of files on the PC and the selection of one of the six languages supported (English, French, German, Italian, Spanish and Chinese) for the user interface and online help.
- The **“About...”** tab displays information about the software.

Note: Regardless of which tab is selected, the connection status with the PAC is continuously displayed, together with commands for connection/disconnection and changing the PAC operating mode.

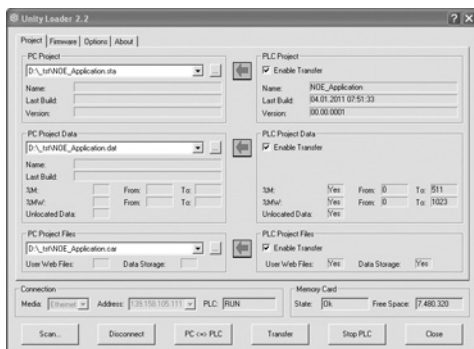

Unity Loader: Project tab

Modicon M340 PAC and BMXRMS●●8MFP memory card only

The Unity Loader software can download the project files and the firmware (controller or module) onto a flash memory card (**BMXRMS●●8MFP** only) plugged into the PAC CPU.

This firmware download can then be used to update a remote Modicon M340 PAC.

Automation of Unity Loader commands

Projects can be downloaded/uploaded between a PAC and a supervisory station equipped with Unity Loader software by means of a command file included in the supervisory application.

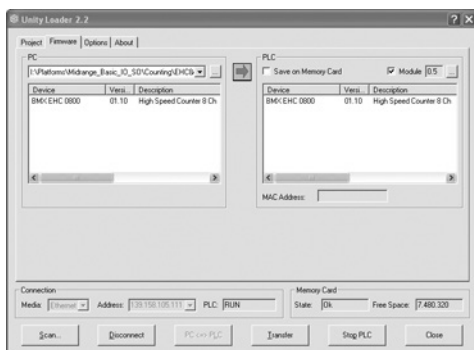

Unity Loader: Firmware tab

Communication between the PC and the PAC

Unity Loader supports the following PC-to-PAC communication:

- Modicon Quantum EcoStruxure Control Expert PACs: Modbus communication, transfer of project components only
- Modicon Premium EcoStruxure Control Expert PACs: Unitelway communication, transfer of project components only
- Modicon M340, M580 or Momentum Unity PACs or Modicon X80 I/O modules: communication via Ethernet and USB ports, transfer of project components and firmware. See the table below:

Reference	Type of module	Ethernet port	USB port
BMXP342000	M340 CPU with Modbus	Supported	Supported
BMXP342010/20103	M340 CPU with CANopen	Supported	Supported
BMXP342020	M340 CPU with integrated Ethernet port	Supported	Supported
BMXP342030/20302	M340 CPU with integrated Ethernet port	Supported	Supported
BMXNOE0100/0110	X80 module Ethernet Modbus/TCP	Supported	Supported
BMXAMI/ART/AMO/AMM	X80 analog I/O module	Supported if CPU has integrated Ethernet port	Supported
BMXEHC0200/0800	X80 counter module	Supported if CPU has integrated Ethernet port	Supported
BMXMSP0200	X80 motion control module	Supported if CPU has integrated Ethernet port	Supported
BMEP58 10●●/20●●/30●●/40●●	M580 CPUs	Supported	Supported
BMENOC03●1	M580 communication module	Supported	Supported
171CBU78090	Momentum Unity CPU with integrated port	Supported	Supported
171CBU98090/ 171CBU98091	Momentum Unity CPU with integrated port	Supported	Supported

Supported
 Supported if CPU has integrated Ethernet port
 Port not available

For Ethernet networks, Unity Loader contains a network scanner that can be used to scan a range of network addresses. Once a recognized Modicon M340, M580, or Momentum Unity PAC has been selected, data transfer operations can be performed.

Compatibility

Unity Loader is independent of EcoStruxure Control Expert and compatible with Modicon M340, M580, or Momentum Unity PACs, EcoStruxure Control Expert Quantum PACs via Modbus, and EcoStruxure Control Expert Premium PAC via Unitelway. The program files and PAC data files are compatible between EcoStruxure Control Expert and Unity Loader.

References

Unity Loader can be downloaded free of charge from our website www.se.com.

Description	Type	Reference
Unity Loader software	Single license (1 station)	Software can be downloaded free of charge from our website www.se.com

Note: In future, all the Unity Loader software features will be replaced by EcoStruxure Automation Device Maintenance .



EcoStruxure Control Expert - Asset Link

Presentation

EcoStruxure Control Expert - Asset Link enables users to create a fully integrated control system to reduce design and commissioning time and deliver long-term system consistency. It integrates systems built with EcoStruxure Control Expert or EcoStruxure Machine Expert that are supervised by AVEVA System Platform.

The various benefits of Asset Link are:

- **Faster design and implementation:** Analyzes the control project and reads the configuration information such as function blocks, data structures (variables), and meta data (comments and initial values), and generates assets in AVEVA System Platform with configured attributes and addresses, thus reducing user engineering time.
- **Simplified system changes:** Simplifies maintenance of control system by continuous monitoring of the controller project and update of the AVEVA System Platform asset attributes.
- **Libraries with pre-defined patterns:** Pre-defined patterns to automatically generate assets in AVEVA System Platform based on the General Purpose Library for Wonderware System Platform when controller code is based on General Purpose Library for EcoStruxure™ Control Expert.
- **Custom patterns:** Generates patterns for customer/project standards based on a sample object type without additional effort.

Features

Asset creation

EcoStruxure Control Expert - Asset Link recognizes an asset based on the function blocks and variables used within the controller. Once recognized, it generates a matching asset using the defined template within the AVEVA System Platform galaxy.

- **Optionality**
Asset Link recognizes assets by a core set of (required) controller assets. It generates rules for any included optional elements only when these elements exist within the controller. When the template is created in AVEVA System Platform, the attributes associated with the assets that exist in the controller are configured and the others are left blank.
- **Customization**
Asset Link rules can be customized so that the existence of controller blocks or variables can enable or disable attributes within the AVEVA System Platform object. Within the General Purpose Library, this allows the object to remove attributes and reduce the processing required for simple assets.
- **Description**
Asset Link uses the description of the asset within the controller as the description of the asset within AVEVA System Platform.

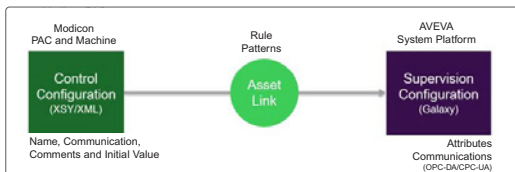

Integrated engineering

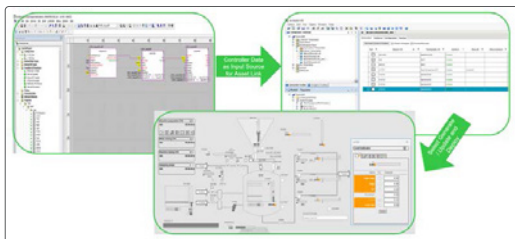

User workflow

Asset binding

EcoStruxure Control Expert - Asset Link detects I/O variables which are read from the controller and binds each instance of the asset to the variables available within the controller.

- **Protocols**
Asset Link recognizes and configures the variable addresses when using OPC-DA, OPC-UA, and OPC UA Embedded (in-rack OPC UA Server modules). The user selects the required protocol and all addresses are formatted as required.

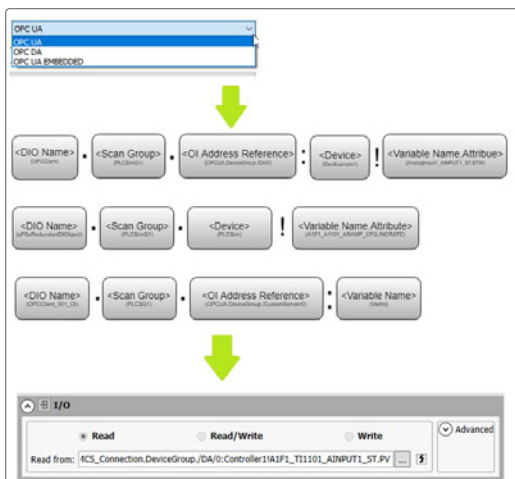

Asset integration and communication setup

Features (continued)

Asset meta data

EcoStruxure Control Expert - Asset Link uses the meta data associated with the variables and function blocks within the controller. This information, which is specific to each instance of an asset, does not change dynamically during Runtime. The data adds value to the user interface by providing more detail as to the state of the controller logic. Using controller configuration within the supervision improves the quality of the controller logic documentation.

Comments

Each input pin for a function block can contain a description of the data that is being connected. During detected failure and interlock conditions, this can provide detail to the operator on the causes that are impacting operation. By replicating this data, Asset Link makes comments available within the controller as well as providing additional insight to the operator.

Initial values

Many parameters are used in both the controller and the supervisory system (analog scaling). When variables are required in both, Asset Link enables the data to be synchronized so that a single value change is required to change the value across the control system.

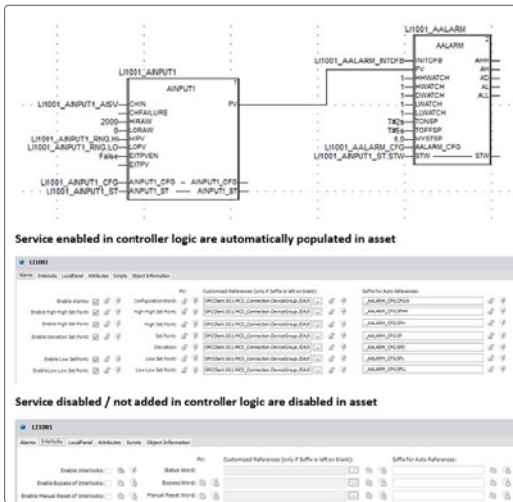

Integration of Asset meta data

Consistency management

EcoStruxure Control Expert - Asset Link monitors changes in the source input file and enables the user to update the generated assets accordingly. It also identifies any conflicts (name and type) between assets and enables the user to resolve them using the "Resolve conflict dialog" function.

Monitor functionality

Users can enable/disable monitoring capabilities on the Asset Link template. When enabled, based on the time interval set by the user, the Asset Link template will monitor for changes in the control project input file and indicate them to the user on detecting a new version.

Resolve conflicts

EcoStruxure Control Expert - Asset Link identifies conflicting assets (conflicts in name or type) and tags them as "To be resolved". The "Resolve conflict dialog" function enables the user to resolve these conflicts.

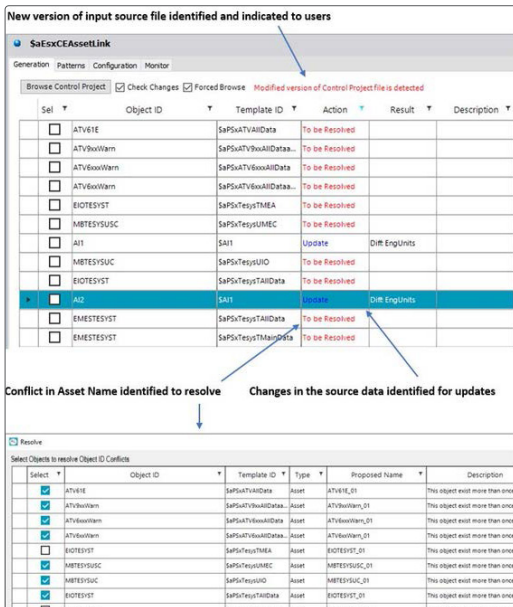

Engineering consistency



2

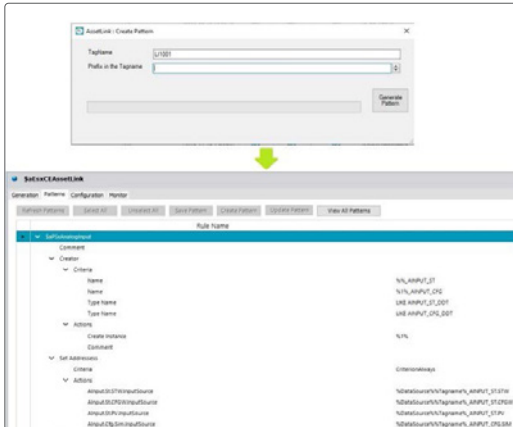

Pattern management

Features (continued)

Patterns

EcoStruxure Control Expert - Asset Link enables the user to configure the controller and the supervisory system for any automation project.

- Sample asset**
 Asset Link generates patterns based on an asset example. A pump in the controller and the supervisory system configured with the maximum capabilities of a pump provides all the information required to generate the pattern. Asset Link recognizes when data from the controller is re-used for supervision and generates the rules.
- Required elements**
 The user must select the required elements of the asset when generating a pattern to allow the same pattern to be used with multiple variations of similar assets.
- Custom rules**
 Patterns can support custom rules by editing the XML files. User rules are identified within the pattern and are not impacted when rules are re-evaluated to update the pattern. Custom rules are typically used to set digital data within the template that cannot be automatically recognized.
- Standards**
 Each controller within the automation system can be linked to a common set of patterns or its own patterns. This allows projects to support multiple sets of standards in different areas of the process.

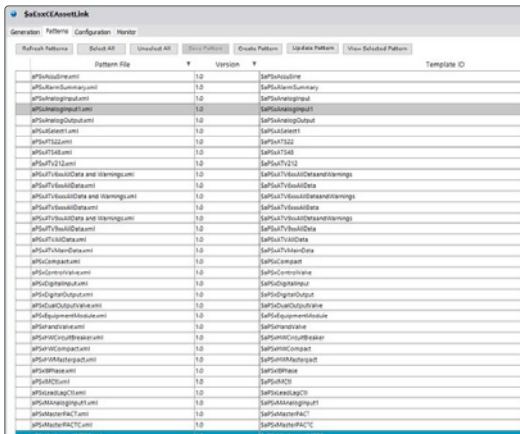

Pattern library

Pattern libraries

Pattern libraries are provided based on their General Process Library.

- AVEVA System Platform (InTouch)**
 Schneider Electric supports patterns that link the General Process Library controller variables with System Platform InTouch libraries for supervision.
- AVEVA System Platform (OMI)**
 Schneider Electric supports patterns that link the General Process Library controller variables with System Platform OMI libraries for supervision.

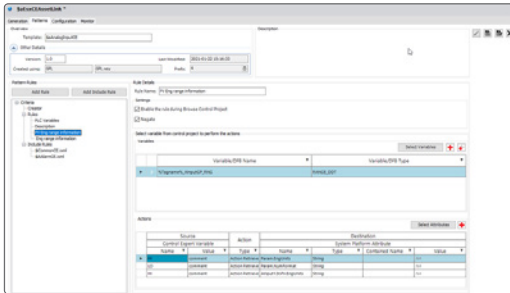

Pattern editing

Features (continued)

Pattern management

Patterns are a key component of Asset Link for defining smart conditions to create assets in a more flexible and consistent methodology with the control code. The user has the capability to manage patterns within the user interface of AVEVA System Platform. Smart definition (edit and refine) of patterns can be achieved using the in-line editor without the need for any XML coding knowledge.

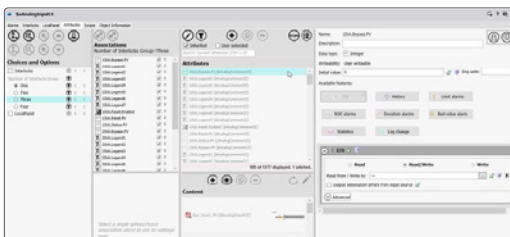

Configuration using Object Wizard

Support templates with Object Wizard

AVEVA System Platform enables users to define templates using Object Wizard for enabling and configuring attributes. Asset Link supports AVEVA System Platform templates created using AOT (Automation Object Toolkit) or Object Wizard.

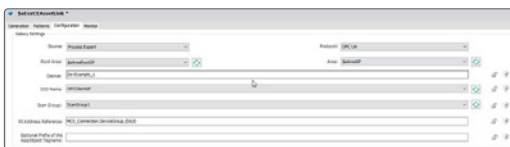

Plant area-wise configuration of assets

Flexibility to select area templates

Area templates allows users to pre-define conditions and add intelligence to assets under the area instances. This version allows users to select the area templates during configuration.

References

Description	Target software	Type	Reference
EcoStruxure Control Expert - Asset Link	EcoStruxure Control Expert and EcoStruxure Machine Expert, available at Schneider Electric Exchange platform shop.exchange.se.com .	Single license	EUSMCNCZZSPEZZ
		Group license	EUSMCNCZZGPEZZ
		Team license	EUSMCNCZZTPEZZ

2



EcoStruxure Control Expert - Modicon Communication Server

Presentation

Modicon Communication Server manages the secured communication configuration between Modicon PAC controllers (M340, M580) and AVEVA System Platform. The server embeds the capabilities of the EcoStruxure OPC Server Expert (for Modicon controllers only) to make all the variables selected for the HMI available within the supervision.

With this server, the only information you need for configuring is the IP address of the controller (or communication card). The configuration, operation, security, and diagnostics are managed within AVEVA System Management Console to provide a single location for configuration.

The various benefits of Modicon Communication Server are:

- **Simplified connection:** Simplifies the process of connecting controllers and the supervisory system together by reducing the number of different applications needed to define and manage communications
- **Direct data access:** Uses OPC Server Expert to transform the controller addresses into names and make it easy to access all the data from the controller
- **Security configuration:** Automatically configures the required security settings to create secure links for the controller communications

Features

Communication server

Modicon Communication Server installs a service version of EcoStruxure OPC Server Expert to manage the communications with Modicon PAC controllers. This enables users to gain access to all variables within the controller by name rather than assigning an address to the variables.

Server management

The user can manage the operation of the communication server from System Management Console. By selecting the Modicon Communication Server node, the user can start, stop, or restart the server through a dropdown menu. The devices previously configured in OFS DA can also be imported to Modicon Communication Server.

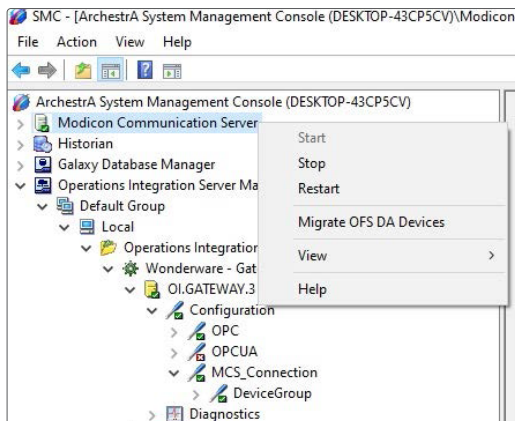

Modicon Communication Server configuration in System Management Console

Controller configuration

Modicon PAC controllers (M340, M580) are set configured by adding them below the communication server node. Each PAC controller requires its IP address(es) to be configured in order to enable communication.

Advanced settings

Additional settings to control the operation of the OPC Server are available for each controller. These parameters are set by default to provide optimal general operation but can be customized to meet specific site needs.

Adjustments are automatically tuned based on the controller type and model selected (M340, M580) to provide optimized communication.

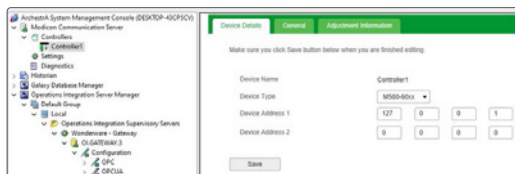

Modicon controller selection for communication configuration

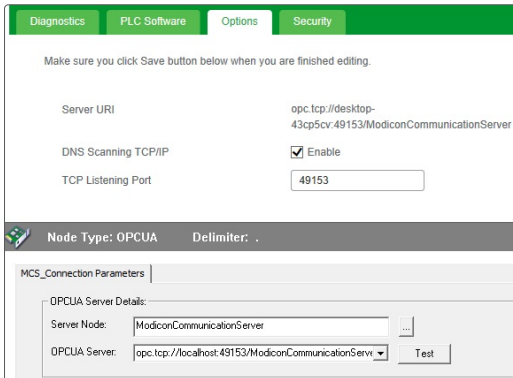

OPC UA communication connection with OI Server

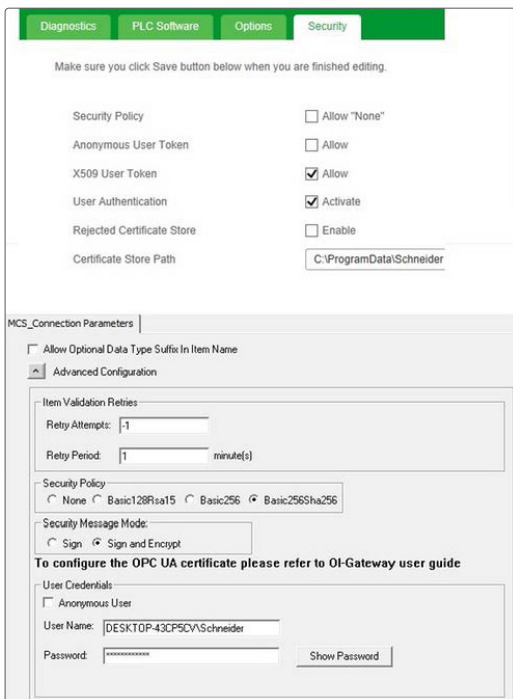

Security configuration

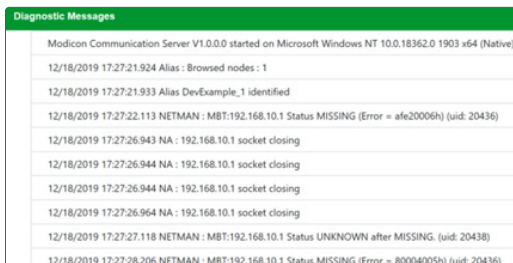

Diagnostic log

Features (continued)

System platform access

The values of variables within the controllers are made available via the OI Server using an OPC-UA client. The configuration of the OPC-UA link is simplified by its co-location with Modicon Communication Server.

Simple configuration

The IP address and server for the OPC-UA client are pre-configured by the location of the server and also displayed as a property of Modicon Communication Server to simplify configuration.

Security settings

By default, Modicon Communication Server is configured with security-enabled settings. The logged-in user needs to enter the credentials in the OI Gateway connection node for completing the security configuration.

Diagnostics

Modicon Communication Server provides diagnostic information from the OPC Server Expert service within the System Management Console. If the Diagnostics tab is selected, the system will display diagnostic information for all controllers defined within the server.

Configurable

The user can define the level of diagnostic information displayed and logged.

References

Modicon Communication Server is a free version software.

Description	Type	Reference
Modicon Communication Server	Single license	Downloadable free version available at Schneider Electric Exchange platform shop.exchange.se.com

2

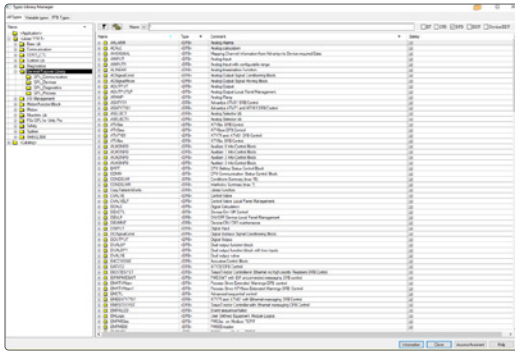

General Purpose Library overview

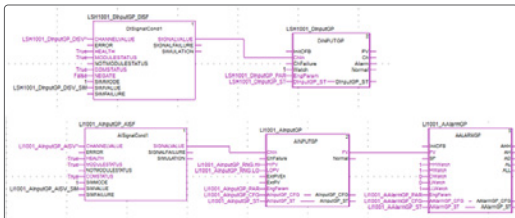

Analog signal conditioning objects

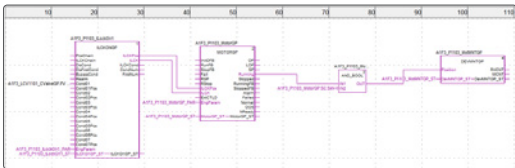

Control module for motors

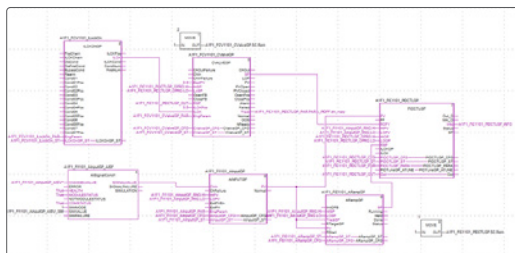

Control loop module

General Purpose Library

General Purpose Library V2 for EcoStruxure Control Expert provides the core automation and device integration function blocks for your automation system. The GPL is provided as a ready-to-use library with open control blocks (read only) to provide easy diagnostics and develop alternatives.

The library is designed to use a network of DFB/DDTs to represent a single asset. This enables the library to offer a simpler diagnostic interface as each detected failure on interlock condition has a single pin and can be animated. It also enables the controller to maximize the resources as assets without a local panel or detected failures can omit elements and reduce the memory required in the controller.

Features

Signals

This is the management of analog and digital I/O (inputs/outputs).

- **Hardware abstraction**
The library is designed to be controller and I/O location independent. The I/O can be connected to any controller through the X80 racks or an STB rack.
- **Signal processing**
Digital inputs (with timestamp), digital outputs, analog inputs (up to 4 sensors), analog outputs (including PWM), and counters are supported. All the inputs are supported by calculation blocks, alarm generation, and totals.
- **Smart sensors**
SCAIME load cells (through PMESWT weighing module) are supported.
- **User setpoints**
Digital, integer, real, and string values can be accepted from the user interface and mapped to controller variables. Analog control values apply a ramp signal to have minimal impact on the process during setpoint changes.
- **Fieldbus communications**
Support is available for device communication through Modbus (serial/Ethernet), Ethernet IP, or Profibus. Communication blocks are available to optimize explicit communications via the Ethernet ports of the controller and communication cards.

Control modules

The control modules are the core blocks that implement the process.

- **Motors**
Motors can be direct, dual speed, dual direction, or variable speed. They have optional components to manage detected device failures, interlock conditions, maintenance data gathering, and control via a local panel.
- **Valves**
Valve control modules are provided for single actuator, dual actuator, rotary valves, motorized On-Off valves, pneumatic valves, and motorized control valves. Valves have optional components for interlocks to open or close the motor and maintenance data. Motorized valves also display detected failures and local panel capabilities.
- **Motor management**
Motors (direct or controlling valves) can be linked to a starter or drive. The library provides TesysT, TesysU, Altistart, and Altivar motor management control.

Process control - continuous

This controls key variables in the process to help ensure the highest possible production of quality and efficiency.

- **Loop control**
Loop control is possible via PID, Lead/Lag, 3Step, Ratio, or Internal Model Control. The loops can be controlled in automatic or manual mode and can be cascaded. Internally, PID control uses the EcoStruxure Control Expert PIDFF control module.
- **Selection**
Control blocks exist to allow a selection of setpoints or control parameters (PID), or to split the impact of the loop output against two control modules.

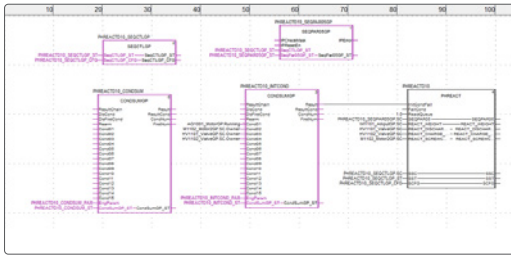

S88 sequence management block

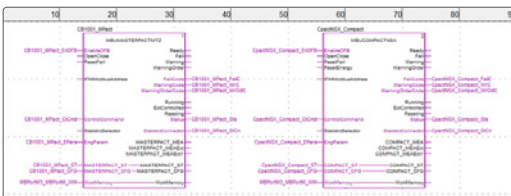

LV power device function block

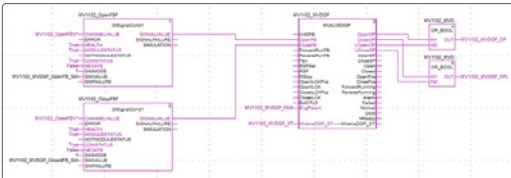

Enhanced functional add-on block

Features (continued)

Process control – sequential

This controls the process executed within the control system.

- **Sequence (S88)**
An S88-compatible sequence engine is available to manage the process. The sequence can manage 999 steps and call child sequences to extend the number of assets under control. User interfaces are available to monitor the progress of the sequence.
- **Phase management (InBatch)**
An S88-compatible engine linked as a phase to InBatch is available to execute the different phase blocks required by inBatch. InBatch can call the phase (with parameters) as required by the batch engine and the phase will interface the recipe with the physical process.
- **Equipment module (NS88)**
An equipment module is used for moving the equipment between modes without stopping. It allows start and stop (like a sequence) but also transition between states of operation.

Power devices

The library allows the status of power devices used within the control system to be controlled and monitored.

Diagnostics

This provides network diagnostic information:

- **Controllers**
M340 and M580 controllers can be monitored by accessing the status registers of the controller.

Enhanced functionalities

This library version provides enhanced functionalities such as additional modes of operation as applicable (simulation and maintenance modes) and single function block for motorized valves (MVALVE and MVALVED) for easy configuration and use.

References

General Purpose Library

There are approximately 100 objects in the General Purpose Library V2, which is compatible with EcoStruxure Control Expert V8.1 and higher versions. This is a free version software.

Description	Type	Reference
General Purpose Library	Single license	Downloadable free version available at Schneider Electric Exchange platform shop.exchange.se.com



EcoStruxure Control Expert specific libraries

Application-specific libraries

The CONT_CTL process control function block library supplied with EcoStruxure Control Expert software can be supplemented with optional specialized libraries to meet specific needs such as:

- Predictive control
- Fuzzy logic controller
- HVAC
- Mass flow calculation

PCR Library

This library is used for predictive control of process applications. Originally developed for reactors, predictive control can be used in other industrial sectors.

Fuzzy Control Library

This library is used in particular in the water treatment field, for example for controlling chlorine levels in freshwater pools or controlling water levels in high-level reservoirs.

Heating, Ventilation and Air Conditioning Library (HVAC)

This library is used in the HVAC field and deals with repetitive temperature control and humidity problems using ventilation equipment.

Flow Calculation Library

This library is used in the vertical Oil & Gas field, for measuring gas flow in compliance with the *American Gas Association (AGA)* standard. This version of the library includes the AGA3, AGA7, and AGA8 function blocks.

Application-specific libraries

Specific libraries depending on the software used can be ordered separately.

Specific libraries

Description	Target software	Type	Reference
PCR Library	EcoStruxure Control Expert	Single license (1 station)	EUSMPCCZZSPAZZ
Fuzzy Control Library			EUSFZCCZZSPAZZ
Heating Ventilation & Air Conditioning Library (HVAC)			EUSHVACZZSPAZZ
Flow Calculation Library			EUSAGACZZSPAZZ

3 - EcoStruxure Control Engineering

EcoStruxure Control Engineering

- Presentation..... [page 3/2](#)
- Tools [page 3/2](#)
- Architecture [page 3/3](#)
- References [page 3/3](#)



EcoStruxure Control Engineering



EcoStruxure Control Engineering - Verification



EcoStruxure Control Engineering - Converter

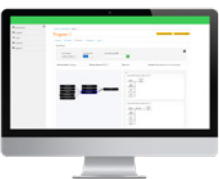

EcoStruxure Control Engineering - Documentation



EcoStruxure Control Engineering - Monitoring

Presentation

EcoStruxure Control Engineering is a collection of software engineering tools for industrial automation that aim to bring a more disciplined, structured approach to control programming in order to increase quality, productivity, and efficiency. The tools help provide a better understanding of your control programs at any stage of the software lifecycle. They also enable you to improve program quality and productivity while reducing costs and time required.

The software tools are all based on a unique technology framework, which enables them to support programs using any of the IEC 61131-3 languages and a number of different PLC/PAC makes and models.

Tools

EcoStruxure Control Engineering - Verification

EcoStruxure Control Engineering - Verification is a static analysis tool for control programs that automates code verification allowing for improved quality management. The tool helps identify non-conformities and measure complexity, providing useful information to help improve your code quality and maintainability.

The EcoStruxure Control Engineering - Verification tool:

- helps ensure the longevity of your control systems by improving maintainability from the start
- automatically verifies conformity with your chosen company, segment, or standard guidelines
- is a collaborative tool providing different levels of information for different users, from an overview of project quality to detailed results

EcoStruxure Control Engineering - Converter

EcoStruxure Control Engineering - Converter is an automatic conversion and reengineering tool for control applications. The tool supports modernization and migration projects by converting a control program to a different controller brand, model, and/or programming language, while maintaining the same behavior and semantics of the source program.

The EcoStruxure Control Engineering - Converter tool:

- saves project time and costs by automating the conversion of the control application
- minimizes risk related to obsolescence, such as unplanned downtime
- helps to prevent loss of your intellectual property and capitalizes on existing investment and know-how

EcoStruxure Control Engineering - Documentation

EcoStruxure Control Engineering - Documentation is a reverse engineering tool for control programs that analyzes and reconstructs program information from an existing source code. The tool generates an abstract representation of the program that is coherent with its current state, making it easier for users to understand even when unfamiliar with the system.

The EcoStruxure Control Engineering - Documentation tool:

- is coherent with the current version of the program
- has built-in knowledge of many legacy systems
- helps to prevent loss of intellectual property from obsolete systems

EcoStruxure Control Engineering - Monitoring

EcoStruxure Control Engineering - Monitoring is a real-time diagnostics solution to support troubleshooting of PLC-based control systems. The solution retrieves the live variable values from the system and displays them on a simplified representation of the control programs, to help understand the current state of a system more quickly and easily. They can be integrated with existing production tools, such as SCADA, version management systems, and communication servers for greater efficiency.

The EcoStruxure Control Engineering - Monitoring tool:

- reduces unplanned downtime with the support of a clear representation of a system's data flow and the live variable values
- increases the autonomy of operational teams
- provides remote access
- enables faster troubleshooting

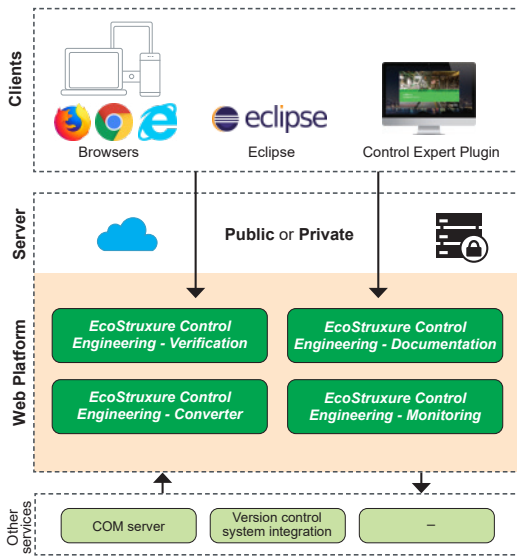

Architecture

The EcoStruxure Control Engineering tools are cloud-based applications accessible through a Web browser, with no installation required. In certain cases, a private server may be required, due to the type of license or the user's security requirements. This is possible and is generally provided on a virtual machine.

The Web browser is the standard client for accessing the tool platform, however it is also possible to use Eclipse (for advanced usage), or specifically for EcoStruxure Control Engineering - Verification, there is also a plugin available for EcoStruxure Control Expert, allowing the tool to be used directly in the development environment.

The advantage of this architecture is that it is flexible, and enables easy integration with other services or third-party tools, such as a communication server or a version control system.



[EcoStruxure Control Engineering](#)
[Click to view video](#)

References

The EcoStruxure Control Engineering products are license-based, Software as a Service (SaaS) tools. They can be accessed through the Web platform, <https://ecostruxure-control-engineering.se.app>. The user needs to create an account and log in to the platform to access their licenses and use the tools.

The platform is based on two different types of server model:

- The public, cloud-based server is the standard model for accessing the tools. With this model, the user will always have access to the latest product versions, can use the collaboration functionalities, and can easily integrate with third-party tools (i.e. version management systems).
- The private server model (1) is generally based on a virtual machine and is aimed for users who have strict security requirements, but also necessary for those purchasing a perpetual license. This model comes at an extra cost.

How to order

The EcoStruxure Control Engineering licenses can be purchased from your local Customer Care Center or a limited selection of licenses are also available to purchase online on the [Schneider Electric Exchange platform](#).

For more information on product references, please refer to the EcoStruxure Control Engineering Catalog:

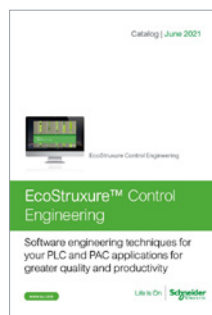

[DIA6ED2210603EN](#)

(1) Updates can only be done by Schneider technical team during on-site visit .

4 - EcoStruxure OPC UA Server Expert

EcoStruxure OPC UA Server Expert

- Presentation..... [page 4/2](#)
- Supported devices and protocols [page 4/2](#)
- Redundant communications [page 4/2](#)
- Use cases [page 4/3](#)
- Supported architectures [page 4/3](#)
- Local access [page 4/3](#)
- Remote access from an OPC UA client..... [page 4/3](#)
- Setup [page 4/4](#)
- System requirements [page 4/5](#)
- References [page 4/5](#)



EcoStruxure OPC UA Server Expert



4

Presentation

EcoStruxure OPC UA Server Expert is a state of the art Schneider Electric communications software platform. It seamlessly links our process automation edge controllers and connected field devices to your information systems and the Industrial Internet of Things (IIoT). The connections are established via the OPC Foundation's Open Platform Communications conforming to the Unified Architecture (OPC UA) service-oriented architecture standard.

The OPC UA standard defines a modern, open communications architecture for industrial communications that enhances cybersecurity and that is scalable from resource constrained sensors through to cloud enterprise systems. OPC UA extends the traditional industrial communications model with a full Service Orientated Architecture (SOA) to publish and manage device metadata, and context, thus helping to eliminate repetition, to simplify system configuration and to reduce maintenance overhead.

Building on the field-proven device integration layer of OPC Factory Server (OFS), EcoStruxure OPC UA Server Expert updates legacy 'OPC Classic' communications provided by OFS with scalable OPC UA connectivity. It helps to maintain more robust and secure integration with current and legacy Schneider Electric third-party field devices.

With the V2.0 release, OPC UA Server Expert provides the following features:

- Compliance with OPC UA V1.03 'Standard Server' profile
- IP-routable, bandwidth-efficient connectivity that helps to ensure communications security
- Compatibility with modern communications infrastructure
- Certificate-based authentication and encryption helping to ensure more robust end-to-end cybersecurity
- Metadata model support to define and communicate data structure, meaning, and context
- Highly-available redundant architectures with auto change over
- Flexible 'many-to-many' device to OPC UA client connectivity
- Online real-time update capabilities
- Support for Modicon located and unlocated symbols
- Assistance in maintaining read-only access to Modicon M580 Safety ePAC symbols

Supported devices and protocols

EcoStruxure OPC UA Server Expert is a multi-device data server, allowing simultaneous use of several communication protocols to multiple field devices. It delivers a range of services to OPC UA clients for communicating with current and legacy field devices and assets via physical address or symbol, while providing support for doing so in a more secure and robust manner.

Supported devices:

- Schneider Electric Process Automation Controllers
- Modicon Quantum, Premium, Compact, and Momentum PACs
- M340 PAC
- M580 ePAC
- Generic Modbus/TCP devices via Ethernet connection

Supported networks and protocols:

- OPC UA binary configurations (based on OPC UA V1.03 standard) enhancing cybersecurity as defined below:
 - None
 - Signed with OPC UA frames
 - Signed and encrypted with OPC UA frames
- Modbus: Modbus serial, Modbus TCP
- XWay/UniTE

Redundant communications

OPC UA Server Expert incorporates native support for a redundant link with Modicon M580 ePAC to increase system availability without impacting the configuration or operational performance upstream OPC UA clients such as SCADA. In the case of a communications interruption, OPC UA Server Expert automatically changes over from the primary to the standby communication path without interrupting upstream OPC UA communications.

Use cases

The inclusion of OPC UA technology within OPC UA Server Expert enables a modern, open approach to industrial device data connectivity, benefiting two different types of user requirements:

- Operational users who wish to directly monitor and control field equipment via supervisory control (SCADA) or human/machine interface applications to manage the real-time operation of industrial processes. These users can take advantage of the high performance and the support delivered by OPC UA Server Expert in providing a more robust and more secure communications platform.
- Analysts or asset owners wishing to consolidate and analyze device and process data to drive performance insight and directed improvement through advanced business intelligence and machine learning techniques. These users can take advantage of the interoperable open standards, flexibility, metamodel capability and simplified SOA integration provided by OPC UA Server Expert.

Supported architectures

EcoStruxure OPC UA Server Expert supports:

- Local or remote access via OPC UA
- Standalone or redundant server operation

Local access

The client application and the EcoStruxure OPC UA Server Expert are on the same PC.

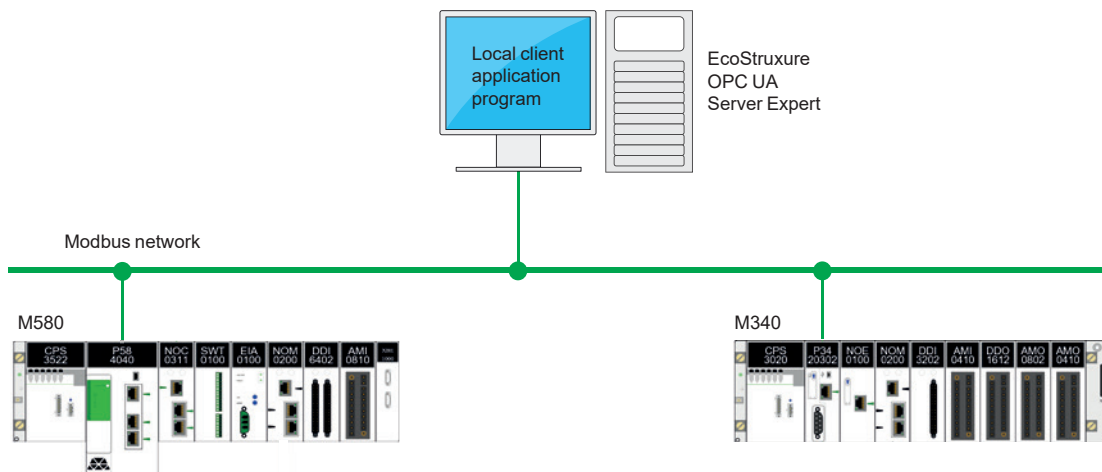

Remote access from an OPC UA client

The client application and the EcoStruxure OPC UA Server Expert are on remote stations. Communication between the client station and the EcoStruxure OPC UA Server Expert is conducted via the OPC UA protocol.

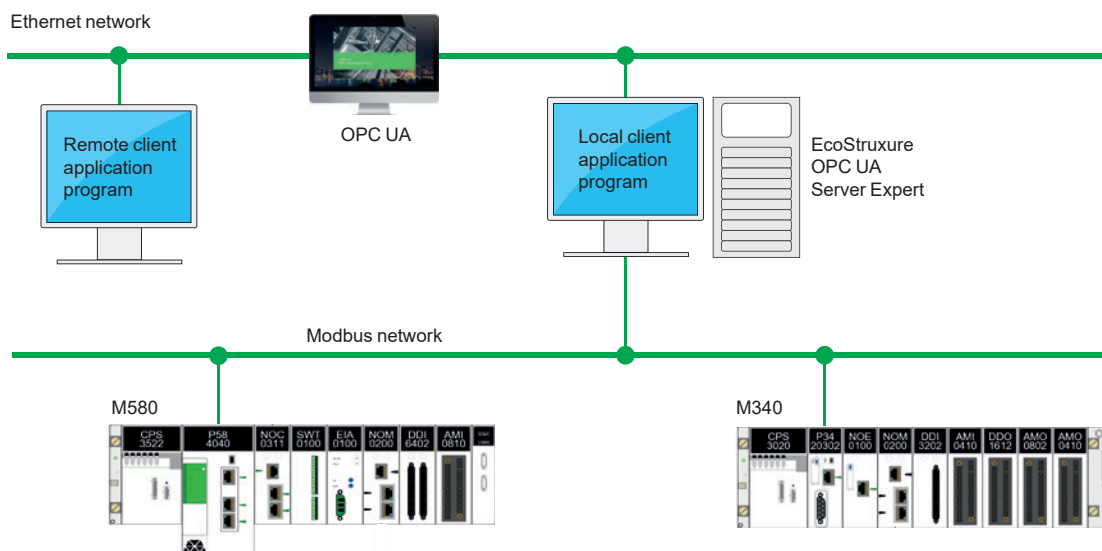

Setup

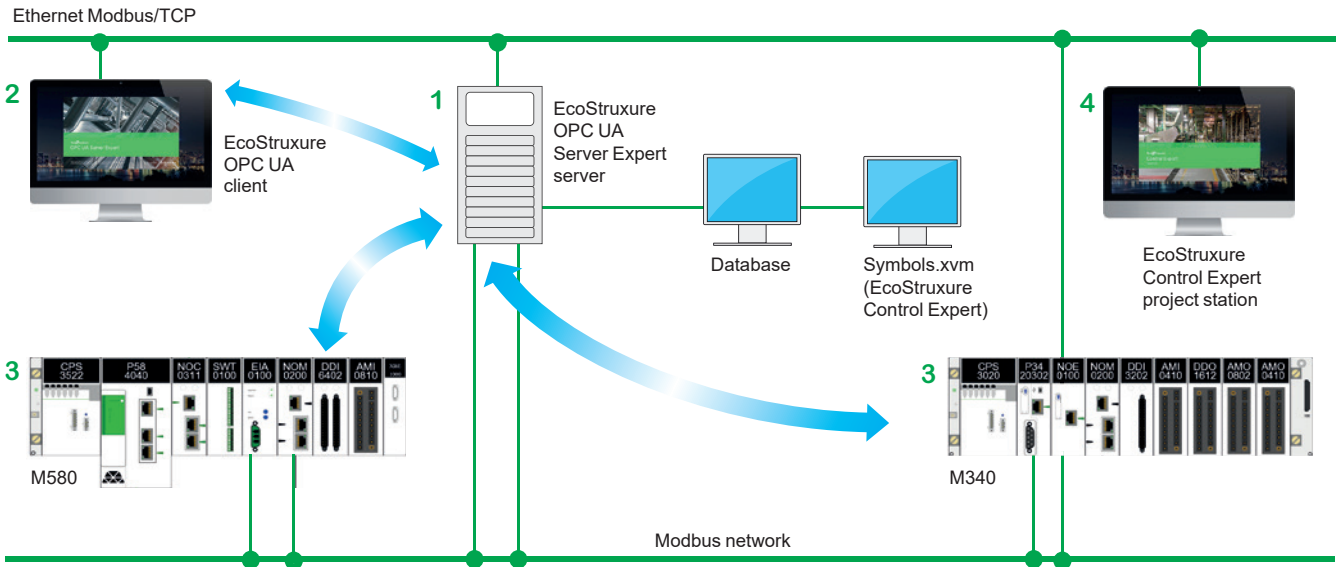

The EcoStruxure OPC UA Server Expert server **1** is at the center of the data exchanges. It makes variables exchanged between the EcoStruxure OPC UA client **2** and the PAC **3** consistent in one of the ways described below using a symbol (or variables) database:

- The variables database is the PAC itself.

In this case, EcoStruxure Control Expert is not needed. This does not apply to the Momentum PAC. If an inconsistency is detected (following online modification of the PAC program for example), the EcoStruxure OPC UA Server Expert server station resynchronizes itself automatically as a background task, without breaking communication between the PAC and the OPC UA client.

For this function, the following minimum versions are required:

- EcoStruxure OPC UA Server Expert V2.0
- EcoStruxure Control Expert V14
- Modicon M340 V2.3, M580 V1.0

- The accessible variables are eventually provided by an export file (XVM format) generated by EcoStruxure Control Expert.

In this case, EcoStruxure Control Expert is not required to be installed on the EcoStruxure OPC UA Server Expert server station.



EcoStruxure OPC UA Server Expert

System requirements

EcoStruxure OPC UA Server Expert V2.0 is compliant with following platforms:

- Microsoft Windows 10
- Microsoft Windows Server® 2012 R2 (1)
- Microsoft Windows Server 2016 (1)

32-bit and 64-bit platforms are supported, with a minimum of 4GB RAM required. Multicore/multiprocessor architectures are highly recommended for optimal runtime performance.

Unity Pro V13, EcoStruxure Control Expert V14 or higher is recommended.

References

The EcoStruxure OPC UA Server Expert V2.0 offer comprises:

- OPC UA server software
- OPC UA server simulator
- OPC UA server configuration software
- An example OPC UA client
- Setup documentation

EcoStruxure OPC UA Server Expert interfaces with variable export files generated by EcoStruxure Control Expert software. It also provides a direct dynamic link to EcoStruxure Control Expert applications.

EcoStruxure OPC UA Server Expert V2.0 software supports an unlimited number of UAP UA symbols (2) within the performance constraints of the hosting server and operating system, and is licenced as single server, 10-server and 100-server site licenses.

EcoStruxure OPC UA Server Expert V2.0

Description	License type	Reference
Paper license		
EcoStruxure OPC UA Server Expert	1 station	OFSUASCZZSPMZZ
	10 stations	OFSUASCZZTPMZZ
	100 stations	OFSUASCZZEPMZZ
Email license		
EcoStruxure OPC UA Server Expert	1 station	OFSUASCZZSPAZZ (3)
	10 stations	OFSUASCZZTPAZZ (3)
	100 stations	OFSUASCZZEPAZZ (3)

(1) Windows Server Remote Desktop Services feature is not supported.

(2) "symbol": variable, structure, table, etc .in the EcoStruxure Control Expert application.

(3) This commercial reference may yet not be available in your country as it depends on the Digital Supply Chain. Please contact your local representative for more details.

5 - OPC Data Server software: OFS (OPC Factory Server), Time stamping system

OPC Data Server software

■ OPC Factory Server

- Presentation [page 5/2](#)
- Supported devices and protocols..... [page 5/2](#)
- Redundant link on Modbus/TCP [page 5/2](#)
- Openness [page 5/2](#)
- Supported architecture [page 5/3](#)
- Setup [page 5/3](#)
- Functions [page 5/4](#)
- References [page 5/5](#)

■ Time stamping system

- Presentation [page 5/6](#)
- Advantages [page 5/6](#)
- Composition of a time stamping architecture [page 5/6](#)
- Performance [page 5/7](#)



OPC Factory Server



Presentation

Based on the OLE for Process Control (OPC) standard, Schneider Electric's OPC Factory Server (OFS) software allows "client" software applications, such as supervisors/SCADA and customized interfaces, to access the data of Schneider Electric automation system and electrical distribution devices connected to networks or fieldbuses in real time.

It also allows communication with third-party devices supporting Modbus and Modbus/TCP protocols.

OFS enables simpler, more open and transparent communication between your software applications and your devices. These are just some of the advantages that result in a complete interoperability solution that is central to your process.

In version V3.6, the OFS provides the following additional features:

- **OPC DA** (OPC Data Access)
- **.NET API interface**
- Native support for a redundant link with the PAC
- Access to time-stamped variables in the PAC or X80 drops
- V3.6 is compatible with Wonderware WSP environment (OPC DA compatible only). More details are available on the Wonderware Global Customer Support site

There are two versions of the OFS V3.6 offer supporting the OPC DA protocol:

- **OFS Small:** Data server for 1,000 items (1).
- **OFS Large:** Data server with an unlimited number of items (1).

Supported devices and protocols

OFS software is a multi-device data server: it allows simultaneous use of several communication protocols, and it provides client applications with a set of services for accessing control system items that may be local or remote, via physical address or via symbol.

Supported devices:

- Modicon Quantum, Premium, M340, M580, Micro, Compact and Momentum PACs
- Schneider Electric TSX Series 7 and April Series 1000 PACs
- Modbus serial devices connected via Schneider Electric gateways: TSXETG10●●, EGX●●● ranges, etc.
- Uni-Telway serial devices connected via Schneider Electric gateways (TSXETG1010)

Supported networks and protocols:

- Modbus: Modbus serial, Modbus Plus, Modbus/TCP
- X-Way/Uni-TE: Uni-Telway, Fipway, ISAWay, PClway

Redundant link on Modbus/TCP

The OFS V3.6 incorporates native support for a redundant link with the PAC in order to optimize system availability without any impact on the SCADA application. OFS automatically changes over from the primary to the standby communication path in case of a communication fault.

Openness

The development of specialized interfaces is simpler with OFS V3.6 software, which is aimed at two types of user in particular:

■ **End users** who want either to interface their supervision or human/machine interface applications with Schneider Electric equipment, or to develop applications on a PC (supervisory control screens, Excel spreadsheets etc.) requiring access to control system data.

■ **Suppliers of control system or industrial data processing software** (supervision, human/machine interfaces, etc.) seeking to develop, within their standard products, an OPC Client interface capable of accessing data in Schneider Electric equipment via the OFS server.

(1) "item": variable, structure, table etc. in the Unity Pro application.



OPC Factory Server: Home page

Supported architecture

Due to the abandon of DCOM technology by Microsoft, OFS supports now local mode only where the client application and the OFS server are on the same PC.

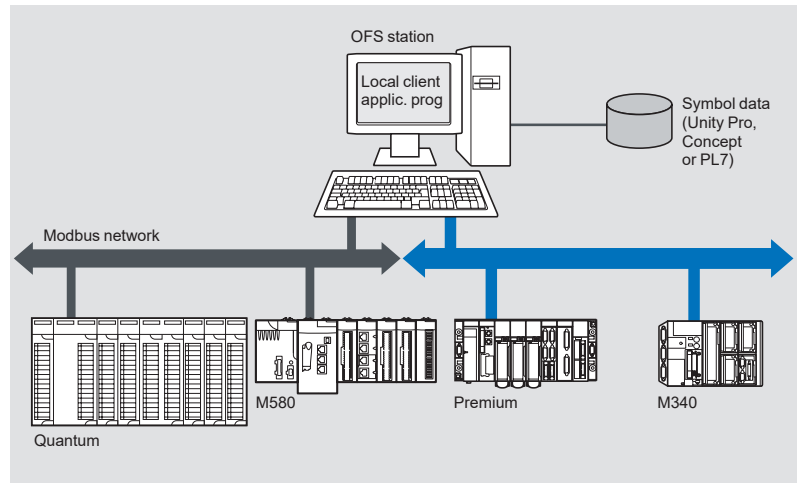

Setup

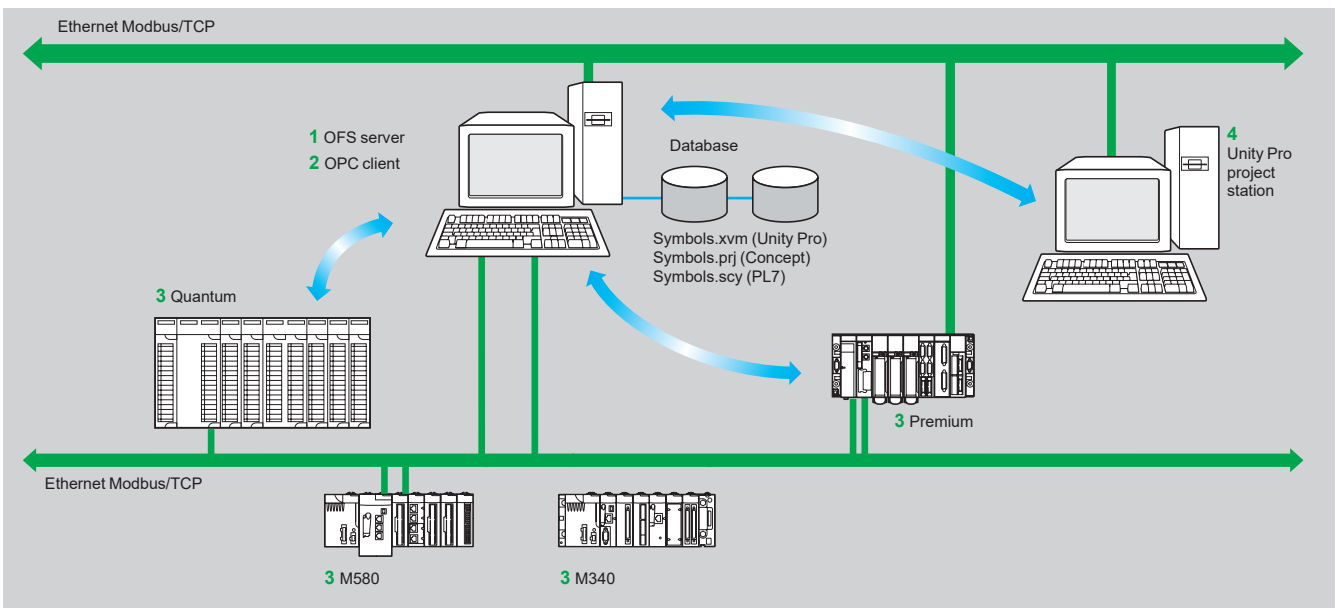

5

The OFS server 1 is at the center of the data exchanges. It makes variables exchanged between the OPC client 2 and the PAC 3 consistent in one of three ways, using a symbol (or variables) database:

- The variables database is either the Unity Pro project 4, or the Concept project. In both these cases, Unity Pro or Concept needs to be installed on the OFS server station.
- Or the variables database is an export file (SCY for PL7, XVM for Unity Pro). PL7 and Unity Pro are not required in either of these cases.
- Or the variables database is the PAC itself. In this case neither Unity Pro nor an export file is needed. This does not apply to Momentum and TSX Micro PACs. If an inconsistency is detected (following online modification of the PAC program for example), OFS resynchronizes itself automatically as a background task, without breaking communication between the PAC and the OPC client.

For this function the following minimum versions are required:

- OFS V3.35
- Unity Pro V6.0
- Modicon M340 V2.3, M580 V1.0, Premium V2.9 and Quantum V3.0 PACs

Functions

Development of client applications

OFS software has 4 types of interface:

■ **OLE Automation interface (OPC DA)**

Particularly suitable for end users, this enables the development of OPC client applications in Visual Basic, in Visual Basic for Excel, and in C++.

■ **OLE Custom interface (OPC DA)**

Used primarily by suppliers of automated control system or industrial IT products, this interface enables the development of applications in C++ in order to access the OFS software OPC server. It is aimed at software development experts in particular, so that they can integrate the client application into their standard products. It is the interface with the highest performance, in terms of access time to data stored in the OPC server. It requires extensive knowledge of C++ programming to set up.

■ **OPC .NET API wrapper interface**

The .NET Microsoft compatibility of the OFS data server gives an OPC .NET client standard access to OFS server items via an Intranet network, thus providing greater interoperability with standard .NET environments.

Note: In this case, communication between the OPC .NET client and the OFS server is conducted through the DCOM layer (or COM layer in a local configuration) via the OPC DA protocol.

Software

OPC Data Server software

OFS (OPC Factory Server)



OPC Factory Server

References

OFS V3.6 software for PC compatible stations (minimum configuration: Pentium 566 MHz processor, 128 MB of RAM) running Windows® 7 (32-bit or 64-bit) or Windows 8 (32-bit or 64-bit).

The OFS V3.6 offer comprises:

- OPC server software
- OPC server simulator (for debugging the application when no PACs are present)
- OFS server configuration software
- An example of OPC client for setting up applications
- The setup documentation on DVD-ROM
- A reference document on “time stamping system” solutions
- A tool to help with sizing and configuring “time stamping system” solutions

Supplied on DVD-ROM, the software operates independently on a PC. It interfaces with the variable export files generated by PL7, ProWORX, Concept, and Unity Pro software.

It also provides a direct dynamic link to the Unity Pro and Concept applications.

OFS V3.6 software is available in two versions :

■ **Small Version TLXCDS●OFS36**

- Maximum of 1,000 items (1)
- Protocol supported: OPC DA
- Single station and 10-station site licenses

■ **Large Version TLXCDL●OFS36**

- Unlimited number of items (1)
- Protocol supported: OPC DA
- Single station, 10-station and 200-station site licenses

OPC Factory Server V3.6 Small

Description	License type	Reference	Weight kg/lb
OPC Factory Server V3.6 Small software ■ Maximum of 1000 items (1) ■ Protocols supported: OPC DA and OPC UA	Single station	TLXCDSUOFS36	–
	10 stations	TLXCDSOFS36	–

OPC Factory Server V3.6 Large

Description	License type	Reference	Weight kg/lb
OPC Factory Server V3.6 Large software ■ Unlimited number of items (1) ■ Protocols supported: OPC DA, OPC XML-DA and OPC UA	Single station	TLXCDLUOFS36	–
	10 stations	TLXCDLTFS36	–
	200 stations	TLXCDFFS36	–

OPC Factory Server V3.6 upgrades

Description	Reference	Weight kg/lb
Update for OPC Factory Server V3.6 Small	TLXCdupSOFS	–
Update for OPC Factory Server V3.6 Large	TLXCdupLOFS	–

(1) “item”: variable, structure, table etc. in the Unity Pro application.

Presentation

The time stamping system is a complete solution providing a SCADA with a sequence of events that are time-stamped at source, enabling the user to analyze the source of any abnormal behavior in an automated system.

The SOE (sequence of events) is displayed in the alarm log or in the list of events for a client such as a SCADA.

Each event in the SOE is a change of value (transition) of a discrete I/O detected by a time stamping module.

Advantages

Using the time stamping system has the following advantages:

- No PAC programming
- Direct communication between the time stamping modules and the client. If the time stamping modules are in an Ethernet I/O drop, the bandwidth of the PAC communication is not used
- Consistency of the I/O values between the process (time stamping modules) and the client
- Consistency is maintained irrespective of the operating mode
- Management of Hot Standby configurations on the PAC and/or SCADA redundancy

Composition of a time stamping architecture

BMXCRA31210 and BMERCRA31210 modules

This time stamping module can be at the source of any discrete I/O signal located in the drop with a resolution of 10 ms.

To avoid losing any events, all events are stored and kept in a buffer located in the product until OFS takes them.

Synchronization of the CRA module uses the NTP protocol.

BMXERT1604T module

This module has 16 discrete inputs which carry out the time stamping on source outputs with a resolution of 1 ms.

To avoid losing any events, the events are stored and kept in a buffer located in the product until OFS takes them.

This module can be placed either in an RIO drop, or in a local rack equipped with a BM•CRA31210 module.

The CRA module is synchronized via the DCF 77 or IRIG-B standards.

OFS V3.6

OFS V3.6 is used to access events stored in the various buffers in the architecture and to notify the SCADA of them via the standard OPC DA protocol.

Time stamped variables can be provided by the BMXERT1604T, discrete modules plugged into X80 drops, or even by the CPU since Unity V10.

Vijeo Citect V7.3

Vijeo Citect V7.3 receives events transmitted by OFS and displays them in the SOE or in the list of alarms.

Wonderware WSP

A specific OFS V3.6 version dedicated to the Wonderware platform is available on the Wonderware Global Customer Support site.

The OFS-WSP driver has the same features as OPC V3.6 – Large apart from the following:

- It is licensed from a Wonderware environment only. It cannot be run outside a Wonderware environment
- It contains the server, the simulator, a sample client, configuration tool, configuration manager, and a user manual
- It is OPC DA compatible only (No OPC UA – No OPC XML)

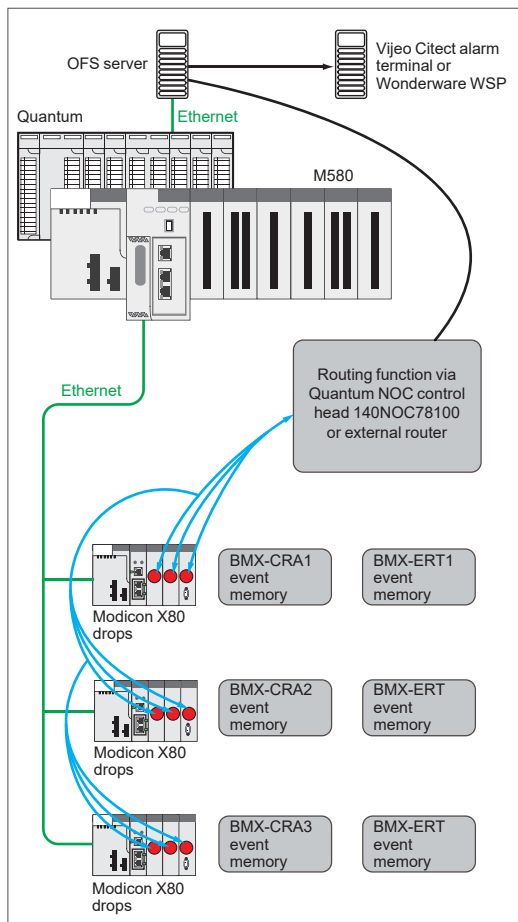

Example of a time stamping architecture

Performance		
Performance	Event source module	Value
Between two identical source modules in the same rack	BMXERT1604T	1.6 < resolution < 3.3 ms
	BM•CRA31210	10 ms
Between two different inputs in the same source module	BMXERT1604T	1 ms
	BM•CRA31210	1 scan
Maximum number of events scanned	BMXERT1604T	400 events (1)
	BM•CRA31210	2,048 events (1)
Maximum number of I/O and memory available	BMXERT1604T	16 discrete inputs on module 512 events in internal buffer
	BM•CRA31210	256 discrete I/O configured 4,000 events in internal buffer
Maximum number of source modules in an Ethernet remote drop	BM•CRA31210	1 per drop
	BMXERT••••	9 per drop
Maximum number of event sources controlled	BMXERT••••	500 sources per second (1)

(1) This maximum value is not an absolute value. It depends on the overall system dynamics (total number of scanned items and number of events generated by the system).

EcoStruxure Process Expert

■ EcoStruxure Process Expert DCS

- Presentation, features [page 6/2](#)
- Libraries [page 6/5](#)
- References [page 6/5](#)

■ EcoStruxure Process Expert for AVEVA System Platform

- Presentation, features [page 6/6](#)
- References [page 6/7](#)



EcoStruxure™ Process Expert Distributed Control System

Presentation

EcoStruxure™ Process Expert Distributed Control System (DCS) (formerly known as EcoStruxure Hybrid DCS) is the process automation system to engineer, operate, and maintain the entire infrastructure for a sustainable, productive, and market-agile plant. This software system enables users to achieve operational profitability from design engineering to meeting the demands of production.

EcoStruxure Process Expert is an essential component of EcoStruxure™ Plant. This is a single environment that interconnects and manages all the components in the automation architecture:

- Standard fieldbuses
- Instrumentation
- Intelligent, connected devices
- Controllers
- Engineering and operator stations
- Alarm management

EcoStruxure Process Expert reduces project execution time and improves process visibility, profitable reliability, and energy utilization.

Features

Efficient and faster engineering

■ **Productive engineering**

EcoStruxure Process Expert is an innovative multi-engineering environment to improve efficiency throughout the engineering and commissioning phase of a plant, accelerating startup and minimizing project risk. The engineering environment is scalable with a collaborative architecture that allows multiple engineers to configure a process automation system, from hardware configuration, communication, controls, and mimics for the supervision.

■ **Configure once**

As an asset-centric system, the EcoStruxure Process Expert enables a single-entry point for configuration of faster system design, fewer errors, system consistency, and quality. Asset data is only entered once and the system design follows the control instrumentation diagram, making control design, installation, and commissioning easier.

■ **Central repository**

EcoStruxure Process Expert centralizes the entire system configuration in single global database. This single database enables active services to share information across all automation system components as well as share real-time engineering data with all users. This centralized repository for the whole system makes engineering and maintenance easier.

■ **Concurrent engineering**

Multiple design teams can work in parallel during the engineering phase, which dramatically reduces design time and cost. EcoStruxure Process Expert enables concurrent engineering in the same system with consistency management. The transparent check-in/check-out mechanism optimizes engineering design, and shares all the work performed across the different engineering workstations in real time.

■ **Comprehensive change tracking**

EcoStruxure Process Expert provides engineering traceability and revision control by recording all system configuration changes. This feature helps to support the verification of changes to comply with the requirements of regulated industries.

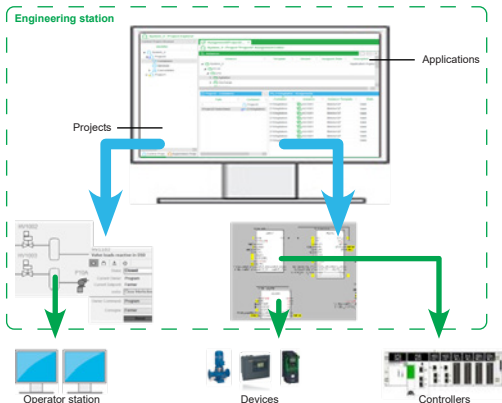

Configure once

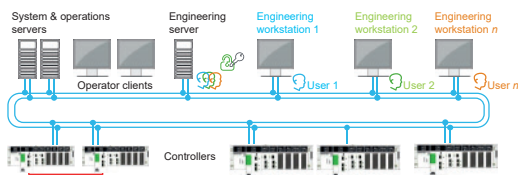

Concurrent engineering

Object	Time	Message	Name	OK	Cluster	Equipment	Item	User/Name
12/Cluster_1	20/10/...	13/1101, Object_ChangeReq...	13/1101, Object_C...	OK	Cluster...	PC38-0101	Channel...	System...
12/Cluster_1	20/10/...	13/1101, Object_ChangeReq...	13/1101, Object_C...	OK	Cluster...	PC38-0101	Channel...	System...
12/Cluster_1	20/10/...	13/1101, Object_ChangeReq...	13/1101, Object_C...	OK	Cluster...	PC38-0101	Channel...	System...
12/Cluster_1	20/10/...	13/1101, Object_ChangeReq...	13/1101, Object_C...	OK	Cluster...	PC38-0101	Channel...	System...
12/Cluster_1	20/10/...	13/1101, Object_ChangeReq...	13/1101, Object_C...	OK	Cluster...	PC38-0101	Channel...	System...
12/Cluster_1	20/10/...	13/1101, Object_ChangeReq...	13/1101, Object_C...	OK	Cluster...	PC38-0101	Channel...	System...
12/Cluster_1	20/10/...	13/1101, Object_ChangeReq...	13/1101, Object_C...	OK	Cluster...	PC38-0101	Channel...	System...
12/Cluster_1	20/10/...	13/1101, Object_ChangeReq...	13/1101, Object_C...	OK	Cluster...	PC38-0101	Channel...	System...
12/Cluster_1	20/10/...	13/1101, Object_ChangeReq...	13/1101, Object_C...	OK	Cluster...	PC38-0101	Channel...	System...
12/Cluster_1	20/10/...	13/1101, Object_ChangeReq...	13/1101, Object_C...	OK	Cluster...	PC38-0101	Channel...	System...

Audit trail

6

Software

EcoStruxure Process Expert

Distributed Control System to engineer, operate, and maintain an entire plant



Asset-centric object model

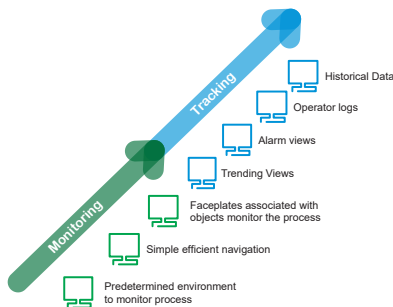

Enhanced operations with situational awareness environment



High-fidelity graphics

Features (continued)

Object-based automation system

■ **Standardization-driven automation system**
EcoStruxure Process Expert provides an end-to-end automation object model to drive standardization across plants and the whole enterprise. With ready-to-use process application libraries, standards can be established resulting in reduced engineering, plant operator training, and maintenance tasks.

An open object mode approach reduces project and operation cost, driving consistency and quality. Additionally, the openness of the automation platform, enables encapsulation of customer standards in application assets, which are created once as templates, and reused consistently across the plant and multiple enterprise sites.

The model represents the physical equipment, containing all the different points of view of the equipment: control logic, graphical representation, data acquisition, alarms, trends, system security, access control, external interfaces, etc.

■ Saves time

- Centralized hardware and software configuration are uniform throughout the platform
- A single global database with configure-once philosophy
- Pre-configured, tested, and validated application template to simplify asset configuration
- Reuse of existing application templates to simplify the duplication of equipment

Running the plant at optimum performance

■ Predefined environment based on situational awareness concepts

Situational awareness design of the operational environment delivers the ability to identify, process, and analyze the critical elements of information about what is happening within the automation system.

EcoStruxure Process Expert provides a consistent control and operational interface with a real-time view of the process. The system delivers operators with all the services and data required to make timely and accurate decisions.

■ Easy process monitoring

The layout of the operation workspace with menus, contextual sub-menus, and banners allow the operator to easily access the data. The color coding of alarm criticality levels and the equipment filtering capability supports and accelerates operator analysis and decision-making.

Operators use faceplates to interact with assets, which provides:

- A user interface for operators to monitor the assets
- Visibility into which missing interlocks are causing the detected problems
- Status data and other information about the assets
- Parameters associated with the assets (e.g. PID)

Software

EcoStruxure Process Expert

Distributed Control System to engineer, operate, and maintain an entire plant

Features (continued)

Workforce empowerment

Digitized plant operations

With EcoStruxure Process Expert, the right person gets the right information at the right time. Data can be accessed in real time for any asset or equipment in the system. This includes the control device running in the controllers, documentation, event historian, asset management, and internet links.

The advanced diagnostics with Runtime Navigation Services is a native service provided by EcoStruxure Process Expert Objects during runtime. These diagnostic services allow the user to access different points of view for each asset, including monitoring control logic, documentation, topological localization, alarms, and trends. This innovative service reduces commissioning time and downtime by quickly identifying the root cause of any detected issues.

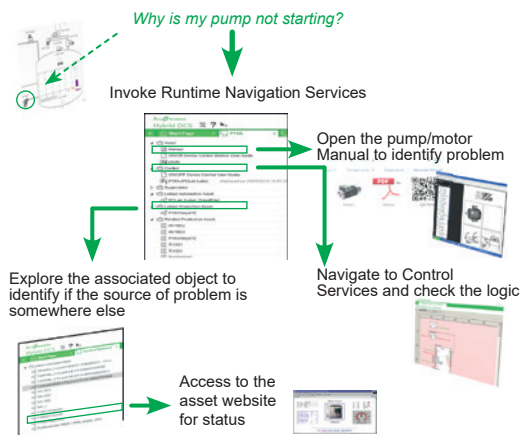

Runtime navigation services

Alarm management

Efficient alarm management allows operators to distinguish critical alarms from routine alarms, and take timely corrective action, thereby reducing plant downtime. The layout of the operation workspace allows users to view alarm information at a glance and the EcoStruxure Process Expert alarm system provides detailed information about the status of plant equipment. With alarm-based navigation, alarms can be filtered according to the equipment hierarchy and severity, enabling the operator to easily zoom into an area of the plant.

Track activity within the system

The operator log enables a plant manager to track all the commands performed by an operator. The different types of information logged are:

- Change of process values
- Bypass of interlock conditions
- User activities like:
 - Manual reset following a detected failure
 - Consignment of a device, device simulation
 - Change of command mode, Operator-to-Program mode, or vice versa

6

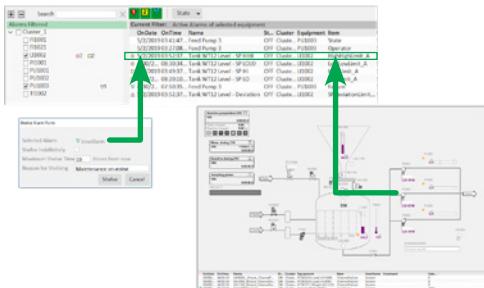

Enhanced alarm management

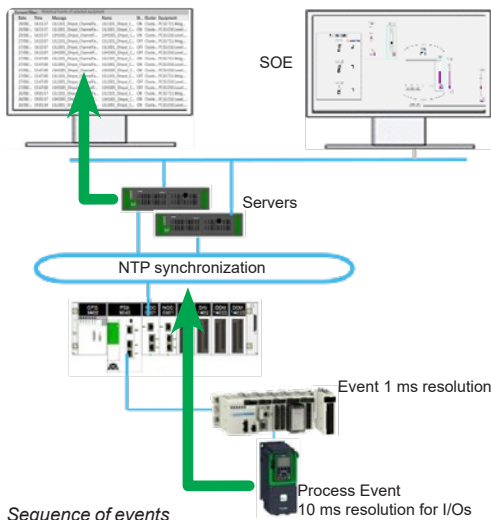

Sequence of events

Software

EcoStruxure Process Expert

Distributed Control System to engineer, operate, and maintain an entire plant

Libraries

EcoStruxure Process Expert process libraries

EcoStruxure Process Expert brings reusable process libraries specifically designed to reduce engineering costs, risk, and time-to-operation. These libraries embed the know-how of years of experience delivering solutions in hybrid industries, and have been tested, validated, and documented.

The process library is designed to provide the components that are required to engineer the core of the automation process. In addition, these libraries enable the integration of Schneider Electric and third-party devices via different open protocols. Automation infrastructure objects extend the functionality beyond the traditional automation layer to integrate smart connected products and software applications within Edge Control. This brings the IIoT from concept to reality within the distributed control system.

Hybrid industry-specific libraries

In addition to the general purpose process library, EcoStruxure Process Expert complements hybrid industries with a set of ready-to-use libraries for specific industries such as Water and Waste Water treatment, cement, mining, and Food & Beverage.

Ready-to-use libraries for energy management and process control

EcoStruxure Process Expert has dedicated libraries for power and energy management and advanced process control. They can be combined with the general purpose and industry-specific libraries to build applications with a consistent look and feel.

The Energy Management Library offers monitoring and measurement of electrical and non-electrical process objects. The aggregation of energy (water, air, gas, electricity, and steam) at each level delivers information to users about energy consumption.

The low Voltage Power Control (LVPC) Library provides the ability to monitor the energy situation in low voltage power circuits in a plant and retain the available energy for the most critical loads by shedding the least critical ones.

The Advanced Process Control Library targets the monitoring and control of complex processes, like a furnace, in the plant.

References

- For EcoStruxure Process Expert licenses, refer to the EcoStruxure Process Expert - Selection guide available at www.se.com.
- For support with control system selection, please contact our Customer Care Center.

Software

EcoStruxure Process Expert for AVEVA System Platform

An integrated process automation system based on Modicon controllers and AVEVA System Platform



EcoStruxure Process Expert for AVEVA System Platform

Presentation

EcoStruxure™ Process Expert for AVEVA System Platform is an integrated automation system managing the complete life cycle of a modern control system based on Modicon controllers and AVEVA System Platform. This integrated automation system enables users to achieve operational profitability from design engineering to meeting the demands of modern-day production.

The EcoStruxure Process Expert process automation system reduces engineering effort and improves operation profitability, maintenance, and plant performance. It provides an asset-centric and object-oriented automation platform to deploy system-wide standards in a digital ecosystem.

Features

High-performance engineering tool

The engineering environment is a scalable, collaborative server/client architecture that allows multiple engineers working at the same time to configure an automation system from the hardware configuration, communication, and control strategies. It is an asset-centric and object-oriented system that enables engineering excellence by reusing standards and applying control strategies to help ensure consistency across multiple controllers and multi-site process control systems.

Ready-to-use general purpose process automation library based on situational awareness

The ready-to-use general purpose libraries are flexible, extensible, configurable, and customizable prebuilt templates for general purpose process applications. It includes a set of standardized automation resources that are verified, validated, documented, and ready to be used to reduce engineering cost and site deployment.

The templates can be configured to meet customer requirements with zero programming. They provide late mapping/binding capabilities, access control, and simulation capabilities to shorten time to market and minimize project risk.

The supervisory facets incorporate situational awareness concepts, advance alarm management, and historical data management to boost plant operator efficiency, delivering the data and production insights needed to make timely and accurate business decisions.

Global navigation

Smart global navigation digitizes plant operation and empowers the workforce. The system diagnostics provide operators with the right information of any plant asset. Operators can access data like control logic monitoring, maintenance procedures, asset documentation, and asset management in real time to contextualize plant assets.

Global navigation also provides operators with real-time cross-references that codify the process knowledge in the system helping them to efficiently operate and maintain the plant, and diagnose and solve detected problems faster.

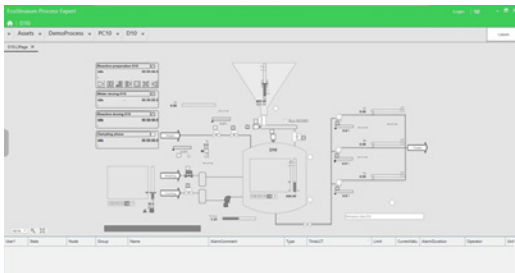

Situational awareness-based operator interface

6

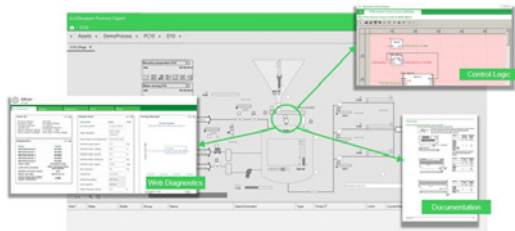

Runtime navigation services

Software

EcoStruxure Process Expert for AVEVA System Platform

An integrated process automation system based on Modicon controllers and AVEVA System Platform

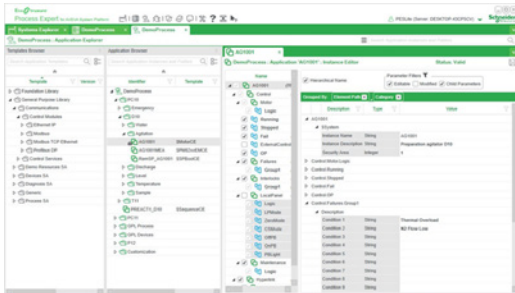

Seamless integration with AVEVA System Platform

Features (continued)

Seamless integration with AVEVA System Platform

An object-oriented system providing a vertical solution by integrating control and supervision with a single-entry point of asset configuration:

- Automatic generation of the plant model
- Automatic generation of application objects
- Automatic population of asset parameters (like identifiers, descriptions, interlock and failure conditions, ranges, engineering units, addresses, etc.) avoiding duplicate entries and configuration errors, and increasing the efficiency and consistency of the control system
- Life cycle services with change management, propagation of changes, and plant asset updates

The integration with AVEVA System Platform provides access to the Unified Operations Center.

References

- For EcoStruxure Process Expert licenses, refer to the EcoStruxure Process Expert for AVEVA System Platform - Selection Guide available at www.se.com.
- For support with control system selection, please contact our Customer Care Center.

Product reference index

- Product reference index..... [page 7/2](#)

#	
110XCA28202	1/31
B	
BMXXCAUSBH018	1/31
BMXXCAUSBH045	1/31
C	
CEXADM CZZEPAZZ	1/29
CEXADM CZZEPBZZ	1/29
CEXADM CZZEPMZZ	1/29
CEXADM CZZEPTZZ	1/29
CEXADM CZZGPAZZ	1/29
CEXADM CZZGPBZZ	1/29
CEXADM CZZGPMZZ	1/29
CEXADM CZZGPTZZ	1/29
CEXADM CZZSPAZZ	1/29
CEXADM CZZSPMZZ	1/29
CEXADM CZZTPAZZ	1/29
CEXADM CZZTPBZZ	1/29
CEXADM CZZTPMZZ	1/29
CEXADM CZZTPTZZ	1/29
CEXADM FZZSPAZZ	1/29
CEXADSC ZZEPBZZ	1/30
CEXADSC ZZEPMZZ	1/30
CEXADSC ZZEPBZZ	1/30
CEXADSC ZZGPAZZ	1/30
CEXADSC ZZGPBZZ	1/30
CEXADSC ZZGPMZZ	1/30
CEXADSC ZZGPTZZ	1/30
CEXADSC ZZSPAZZ	1/30
CEXADSC ZZSPMZZ	1/30
CEXADSC ZZTPAZZ	1/30
CEXADSC ZZTPBZZ	1/30
CEXADSC ZZTPMZZ	1/30
CEXADSC ZZTPTZZ	1/30
CEXSPMC ZXEPBZZ	1/28
CEXSPMC ZXEPMZZ	1/28
CEXSPMC ZXEPBZZ	1/28
CEXSPMC ZXGPAZZ	1/28
CEXSPMC ZXGPBZZ	1/28
CEXSPMC ZXGPMZZ	1/28
CEXSPMC ZXGPTZZ	1/28
CEXSPMC ZXSPAZZ	1/28
CEXSPMC ZXSPMZZ	1/28
CEXSPMC ZXTPAZZ	1/28
CEXSPMC ZXTPBZZ	1/28
CEXSPMC ZXTPMZZ	1/28
CEXSPMC ZXTPBZZ	1/28
CEXSPMC ZXTPMZZ	1/28
CEXSPMC ZXTPBZZ	1/28
CEXSPME ZXEPBZZ	1/28
CEXSPME ZXEPBZZ	1/28
CEXSPMF ZXSPAZZ	1/28
CEXSPUC ZLGAZZ	1/25
CEXSPUC ZLGPMZZ	1/25
CEXSPUC ZLSPAZZ	1/25
CEXSPUC ZLSPMZZ	1/25
CEXSPUC ZLTPAZZ	1/25
CEXSPUC ZLTPMZZ	1/25
CEXSPUC ZSGPAZZ	1/24
CEXSPUC ZSGPMZZ	1/24
CEXSPUC ZSSPAZZ	1/24
CEXSPUC ZSSPMZZ	1/24
CEXSPUC ZSTPAZZ	1/24

CEXSPUC ZSTPMZZ	1/24
CEXSPUC ZXEPBZZ	1/26
CEXSPUC ZXEPBZZ	1/26
CEXSPUC ZXEPMZZ	1/26
CEXSPUC ZXEPBZZ	1/26
CEXSPUC ZXGPAZZ	1/26
CEXSPUC ZXGPBZZ	1/26
CEXSPUC ZXGPMZZ	1/26
CEXSPUC ZXGPTZZ	1/26
CEXSPUC ZXSPAZZ	1/26
CEXSPUC ZXSPMZZ	1/26
CEXSPUC ZXTPAZZ	1/26
CEXSPUC ZXTPBZZ	1/26
CEXSPUC ZXTPMZZ	1/26
CEXSPUC ZXTPBZZ	1/26
CEXSPUC ZXTPMZZ	1/26
CEXUASC ZZSPAZZ	1/30
CEXUASC ZZSPMZZ	1/30
CEXUASC ZZTPAZZ	1/30
CEXUASC ZZTPBZZ	1/30
CEXUASC ZZTPMZZ	1/30
CEXUMDE ZXEPBZZ	1/28
CEXUMDE ZXEPBZZ	1/28
CEXUMDF ZXSPAZZ	1/28
CEXUMFC ZXEPBZZ	1/29
CEXUMFC ZXEPBZZ	1/29
CEXUMFC ZXGPBZZ	1/29
CEXUMFC ZXGPTZZ	1/29
CEXUMFC ZXTPBZZ	1/29
CEXUMFC ZXTPBZZ	1/29
CEXUMFC ZXTPMZZ	1/29
CEXUMNC ZXEPBZZ	1/29
CEXUMNC ZXEPBZZ	1/29
CEXUMNC ZXEPMZZ	1/28
CEXUMNC ZXEPMZZ	1/28
CEXUMNC ZXEPBZZ	1/28
CEXUMNC ZXGPAZZ	1/29
CEXUMNC ZXGPMZZ	1/28
CEXUMNC ZXTPAZZ	1/29
CEXUMNC ZXTPBZZ	1/29
CEXUMNC ZXTPMZZ	1/28
CEXUMNC ZXTPMZZ	1/28
CEXUMNF ZXSPAZZ	1/29
CEXUPDC ZLGAZZ	1/25
CEXUPDC ZLGPMZZ	1/25
CEXUPDC ZLSPAZZ	1/25
CEXUPDC ZLSPMZZ	1/25
CEXUPDC ZLTPAZZ	1/25
CEXUPDC ZLTPMZZ	1/25
CEXUPDC ZSGPAZZ	1/24
CEXUPDC ZSGPMZZ	1/24
CEXUPDC ZSSPAZZ	1/24
CEXUPDC ZSSPMZZ	1/24
CEXUPDC ZSTPAZZ	1/24
CEXUPDC ZSTPMZZ	1/24
CEXUPDC ZXEPBZZ	1/26
CEXUPDC ZXEPBZZ	1/26
CEXUPDC ZXEPMZZ	1/26
CEXUPDC ZXEPBZZ	1/26
CEXUPDC ZXGPAZZ	1/26
CEXUPDC ZXGPBZZ	1/26
CEXUPDC ZXGPMZZ	1/26
CEXUPDC ZXGPTZZ	1/26
CEXUPDC ZXGPAZZ	1/26
CEXUPDC ZXSPAZZ	1/26

CEXUPDC ZXSPMZZ	1/26
CEXUPDC ZXTPAZZ	1/26
CEXUPDC ZXTPBZZ	1/26
CEXUPDC ZXTPMZZ	1/26
CEXUPDC ZXTPBZZ	1/26
CEXUPDC ZXTPMZZ	1/26
CEXUPGC ZLGAZZ	1/25
CEXUPGC ZLGPMZZ	1/25
CEXUPGC ZLSPAZZ	1/25
CEXUPGC ZLSPMZZ	1/25
CEXUPGC ZLTPAZZ	1/25
CEXUPGC ZLTPMZZ	1/25
CEXUPGC ZXEPBZZ	1/27
CEXUPGC ZXEPBZZ	1/27
CEXUPGC ZXEPBZZ	1/27
CEXUPGC ZXGPAZZ	1/27
CEXUPGC ZXGPBZZ	1/27
CEXUPGC ZXGPMZZ	1/27
CEXUPGC ZXGPTZZ	1/27
CEXUPGC ZXSPAZZ	1/27
CEXUPGC ZXSPMZZ	1/27
CEXUPGC ZXTPAZZ	1/27
CEXUPGC ZXTPBZZ	1/27
CEXUPGC ZXTPMZZ	1/27
CEXUPGC ZXTPBZZ	1/27
CEXUPGC ZXTPMZZ	1/27
CEXUPNC ZLGAZZ	1/25
CEXUPNC ZLGPMZZ	1/25
CEXUPNC ZLTPAZZ	1/25
CEXUPNC ZLTPMZZ	1/25
CEXUPNC ZSGPAZZ	1/24
CEXUPNC ZSGPMZZ	1/24
CEXUPNC ZSTPAZZ	1/24
CEXUPNC ZSTPMZZ	1/24
CEXUPNC ZXEPBZZ	1/27
CEXUPNC ZXEPBZZ	1/27
CEXUPNC ZXEPMZZ	1/27
CEXUPNC ZXEPBZZ	1/27
CEXUPNC ZXGPAZZ	1/27
CEXUPNC ZXGPMZZ	1/27
CEXUPNC ZXTPAZZ	1/27
CEXUPNC ZXTPBZZ	1/27
CEXUPNC ZXTPMZZ	1/27
CEXUPNC ZXTPBZZ	1/27
CEXUPNC ZXTPMZZ	1/27
E	
EUSAGAC ZZSPAZZ	2/19
EUSFZCC ZZSPAZZ	2/19
EUSHVAC ZZSPAZZ	2/19
EUSMCNC ZZGPEZZ	2/13
EUSMCNC ZZSPEZZ	2/13
EUSMCNC ZZTPEZZ	2/13
EUSMPCC ZZSPAZZ	2/19
O	
OFSUASC ZZSPAZZ	4/5
OFSUASC ZZEPMZZ	4/5
OFSUASC ZZSPAZZ	4/5
OFSUASC ZZSPMZZ	4/5
OFSUASC ZZTPAZZ	4/5
OFSUASC ZZTPMZZ	4/5
S	
SR2CBL06	1/31
STBXCA4002	1/31
T	
TLXCDLFOFS36	5/7
TLXCDLTOFS36	5/7

TLXCDLUOFS36	5/7
TLXC DSTOFS36	5/7
TLXCDSUOFS36	5/7
TLXCDUPDLOFS	5/7
TLXCDUPDSOFS	5/7
U	
UNYDFFXZZSPA80	2/7
UNYSPUZFUCD80	2/5
UNYXCAUSB033	1/31

Life Is On



Learn more about our products at
www.se.com

The information provided in this documentation contains general descriptions and/or technical characteristics of the performance of the products contained herein. This documentation is not intended as a substitute for and is not to be used for determining suitability or reliability of these products for specific user applications. It is the duty of any such user or integrator to perform the appropriate and complete risk analysis, evaluation and testing of the products with respect to the relevant specific application or use thereof. Neither Schneider Electric nor any of its affiliates or subsidiaries shall be responsible or liable for misuse of the information contained herein.

Design: Schneider Electric
Photos: Schneider Electric

Schneider Electric Industries SAS

Head Office
35, rue Joseph Monier - CS 30323
F-92500 Rueil-Malmaison Cedex
France

MKTED2140504EN
February 2022 - V9.0