

Transparent object detection sensor in compact stainless steel housing

E3ZM-B

The E3ZM-B provides enhanced detection stability for the detection of transparent materials. The models for all transparent materials allow an easy and intuitive adjustment by potentiometer or teach button to adjust to individual requirements. The PET optimised model provides additional and auto-controlled measures for highest stability on PET materials.

- Easy adjustment to individual requirements for all transparent materials
- Stable PET detection with optimised detection settings and AC³ power control technology
- Detergent resistant compact SUS316L housing
- Coaxial optics for stable, distance-independent detection



Ordering Information

Sensor type		Sensing distance	Special reflector	Connection method				Order code	
								NPN output	PNP output
Retro-reflective with M.S.R. 	Optimised for PET bottles and trays	0 to 500 mm (teachable)	Order separately* ² E39-RP1 included	–	–	2 m	–	E3ZM-B61 2M	E3ZM-B81 2M
				■	–	–	–	E3ZM-B66	E3ZM-B86
				–	–	2 m	–	E3ZM-B61-C 2M	E3ZM-B81-C 2M
	For all transparent media (glass, PET, foils)	0 to 500 mm (potentiometer adjustment)* ³	Order separately* ⁴	–	–	2 m	–	E3ZM-B61T 2M	E3ZM-B81T 2M
				■	–	–	–	E3ZM-B66T	E3ZM-B86T

*1. For ordering pigtail versions contact your OMRON representative. Available options on request are:

- S1J: for M12 4-pin stainless steel plug with 30 cm cable
- S3J: for M8 4-pin stainless steel plug with 30 cm cable
- S5J: for M8 3-pin stainless steel plug with 30 cm cable (only E3ZM-B_T)
- M1J: for M12 4-pin brass plug with 30 cm cable
- M3J: for M8 4-pin brass plug with 30 cm cable
- M5J: for M8 3-pin brass plug with 30 cm cable (only E3ZM-B_T)
- M1TJ: for M12 4-pin brass XS5 click connector plug with 30 cm cable.

*2. For higher signal stability for PET bottles, order special reflector E39-RP1 separately.

*3. Teachable all-transparent-media types are available. Contact your OMRON representative.

*4. Order reflector separately.

Features

Enhanced detection stability on PET (PET optimised models)



Utilisation of double reflection effect in PET for higher detection stability (PET optimised models)

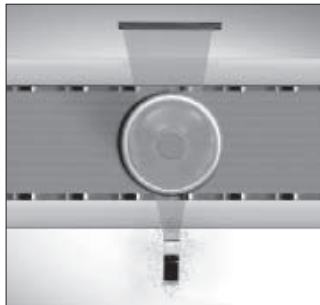

Automatic LED power adjustment (AC³) to compensate for soiling and temperature fluctuations

Robust housing and easy adjustment









Detergent and high pressure water resistant (see page 9 for more info)



Easy adjustment by potentiometer or teach button



Mounting Brackets

Appearance	Model (Material)	Quantity	Remarks	Appearance	Model (Material)	Quantity	Remarks
	E39-L104 (SUS304)	1	Standard surface mounting (pre-wired models)		E39-L150 (SUS304)	1 set	Telescope mounting
	E39-L43 (SUS304)	1	Protection wall mounting (pre-wired models)		E39-L151 (SUS304)	1 set	
	E39-L142 (SUS304)	1					
	E39-L44 (SUS304)	1	Back wall mounting		E39-L144 (SUS304)	1	Protection surface mounting

Note: for the complete range of mounting brackets refer to accessory datasheet E26E.



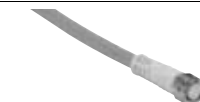

Cable connectors

For the complete list of cable connectors refer to E26E accessory datasheet.

Size	Shape	Type	Features	Material		Order code	
				Nut	Cable		
M8		General purpose (screw)	4pin	Brass (CuZn)	PVC 2 m PUR 2 m	XS3F-M8PVC4S2M XS3F-M8PUR4S2M	XS3F-M8PVC4A2M XS3F-M8PUR4A2M
		Detergent resistant		Stainless steel (SUS316L)	PVC 2 m	Y92E-S08PVC4S2M-L	Y92E-S08PVC4A2M-L

Reflectors

For the complete list of reflectors refer to E26E accessory datasheet.

Shape	Type	Housing material	Features	Size in mm	Order code
	General purpose reflectors	ABS base Acrylic surface	Surface screw mounting (diagonal holes)	40x60x7.5	E39-R1S
	Enhanced detergent resistance	PVC	Surface screw mounting IP69k after DIN 40050 part 9	40x60x7.5	E39-R50
				20x60x6	E39-R51
	Highest detergent resistance	SUS316L Borosilicat	Surface screw mounting	43x30x5	E39-R16
	Special polarizing	ABS base PMMA surface	Special polarizing filter for PET bottles - in combination with E3ZM-B models for PET only	44x80x8.5	E39-RP1

Ratings and Specifications

Item	Optimised for PET	For all transparent objects	
	E3ZM-B_	E3ZM-B_T	
Sensing distance	0 to 500 mm (Using E39-RP1); min distance to reflector: 100 mm		
Standard sensing object	500-ml, transparent, round PET bottle (65-mm dia.)		
Directional angle	Sensor: 3° to 10° Reflector: 30°		
Light source (wavelength)	Red LED (650 nm)		
Power supply voltage	10 to 30 VDC, including 10% ripple (p-p)		
Current consumption	450 mW max. (15 mA at 30 VDC)	25 mA max.	
Control output	Load power supply voltage: 30 VDC max., Load current: 100 mA max. (Residual voltage: 2 V max.) Open-collector output (NPN/PNP output depending on model)		
Operating modes	Light-ON/Dark-ON selectable by wire	Light-ON/Dark-ON switch selectable	
Protective circuits	Reversed power supply polarity, load short-circuit protection, mutual interference prevention, reversed output polarity protection		
Response time	Operation or reset: 1 ms max.		
Sensitivity adjustment	Teach button	one-turn adjuster	
Ambient illumination	Incandescent lamp: 3,000 lx max., Sunlight: 10,000 lx max.		
Ambient temperature range	Operating: -40 to 60°C (*1), Storage: -40 to 70°C (with no icing or condensation)	Operating: -25 to 55°C Storage: -40 to 70°C (with no icing or condensation)	
Ambient humidity range	Operating: 35% to 85%, Storage: 35% to 95% (with no condensation)		
Insulation resistance	20 MΩ min. at 500 VDC		
Dielectric strength	1,000 VAC, 50/60 Hz for 1 min		
Vibration resistance	Destruction: 10 to 55 Hz, 1.5-mm double amplitude for 2 hours each in X, Y, and Z directions		
Shock resistance	Destruction: 500 m/s ² 3 times each in X, Y, and Z directions		
Degree of protection	IEC 60529: IP67, DIN 40050-9: IP69K (*2)		
Connection method	Pre-wired cable (standard length: 2 m) or M8 4-pin connector		
Indicator	Operating indicator (yellow), Stability indicator (green), and Teaching indicator (red)		
Weight (packed state)	Pre-wired models: Approx. 90 g Connector models: Approx. 40 g		
Materials	Housing	SUS316L	
	Lens	PMMA (polymethylmethacrylate)	
	Indicator	PES (polyethersulfone)	
	Buttons/adjusters	Fluoro rubber	PEEK (polyetheretherketone)
	Cable	PVC (polyvinyl chloride)	
Accessories	Instruction sheet, (special reflector E39-RP1 for E3ZM-B_-C only)*4		

*1. Do not bend the cable in temperatures of -25°C or lower.

*2. IP69K Degree of protection specification (for measures for improving the protection against water ingress see page 9). IP69K is a protection standard against high temperature and high-pressure water defined in the German standard DIN 40050, Part 9. The test piece is sprayed with water at 80°C at a water pressure of 80 to 100 BAR using a specified nozzle shape at a rate of 14 to 16 liters/min.

The distance between the test piece and nozzle is 10 to 15 cm, and water is sprayed horizontally for 30 seconds each at 0°, 30°, 60°, and 90° while rotating the test piece on a horizontal plane.

*4 For reflectors and mounting brackets refer to Accessories.

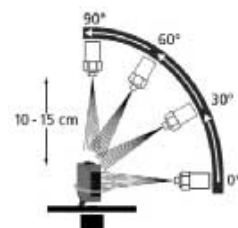

Engineering Data (Typical)

Parallel Operating Range (Horizontal)

E3ZM-B
(measured with E39-RP1)

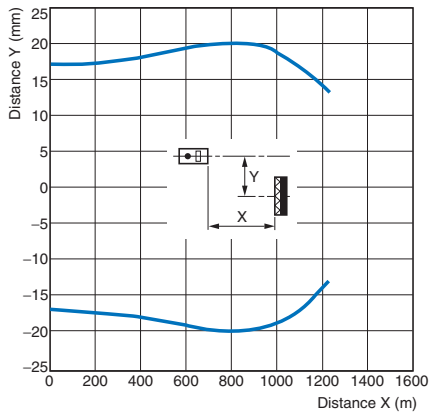

Parallel Operating Range (Vertical)

E3ZM-B
(measured with E39-RP1)

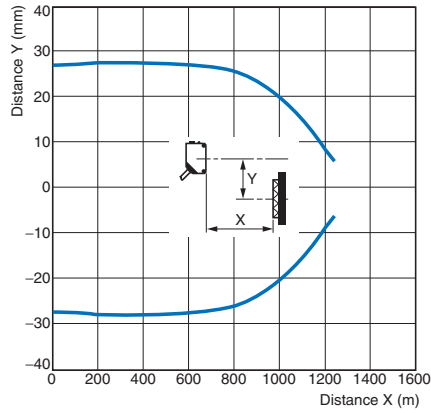

Excess Gain vs. Distance

E3ZM-B
(measured with E39-RP1)

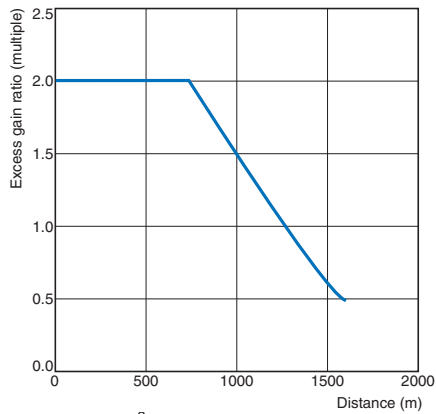

Note: The AC³ function controls the excess gain ratio to be a constant multiple of 2.

Dark Excess Gain vs. Sensing Object Characteristics (PET optimised models)

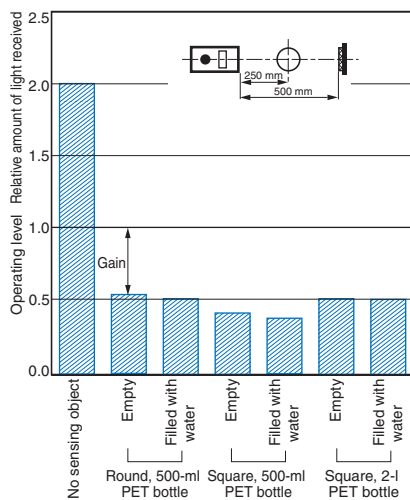

Dark Excess Gain vs. Position (PET optimised models)

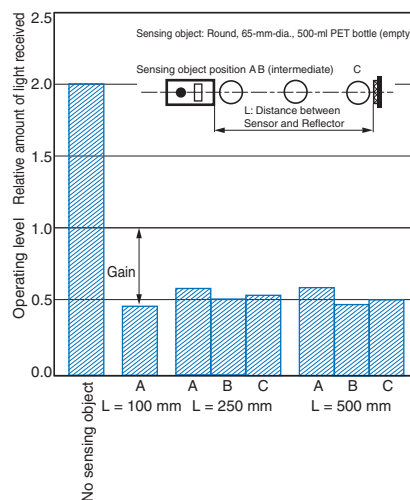

I/O Circuit Diagrams

PET optimised models

NPN Output

Model	Operation mode	Timing charts	Operation selector	Output circuit
E3ZM-B61 E3ZM-B66	Light-ON		Connect pink lead (2) to brown lead (1).	<p>M8 Connector Pin Arrangement</p>
	Dark-ON		Connect pink lead (2) to blue lead (3) or leave open.	

All transparent material models

NPN Output

Model	Operation mode	Timing charts	Operation selector	Output circuit
E3ZM-B61T E3ZM-B66T	Light-ON		Set switch to L-ON	<p>M8 Connector Pin Arrangement</p>
	Dark-ON		Set switch to D-ON	

PET optimised models

PNP Output

Model	Operation mode	Timing charts	Operation selector	Output circuit
E3ZM-B81 E3ZM-B86	Light-ON		Connect pink lead (2) to brown lead (1).	<p>M8 Connector Pin Arrangement</p>
	Dark-ON		Connect pink lead (2) to blue lead (3) or leave open.	

All transparent material models

PNP Output

Model	Operation mode	Timing charts	Operation selector	Output circuit
E3ZM-B81T E3ZM-B86T	Light-ON		Set switch to L-ON	<p>M8 Connector Pin Arrangement</p>
	Dark-ON		Set switch to D-ON	

Nomenclature

Models with teach button

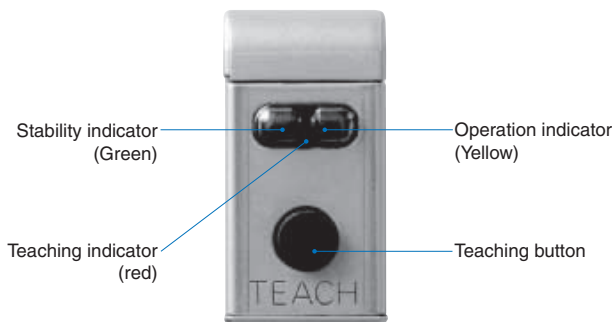

Models with potentiometer adjuster

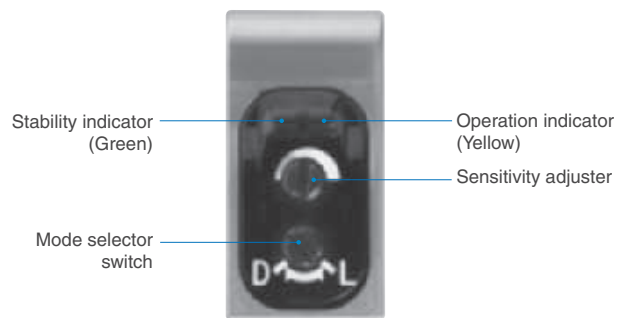

Teaching Method

(for models with teach-button)

Note: When the Sensor is first unpacked and used, the teaching indicator (red) will flash slowly to show that teaching has not yet been done. This does not indicate a malfunction. Use the following procedure to conduct teaching.

- 1. Install the Sensor and Reflector and adjust the optical axis (without placing a PET bottle between them). Then press and hold the teaching button for at least 2 seconds.**

The teaching indicator (red) will start flashing quickly.
Perform the following operation within 7 seconds after first starting to press the teaching button.
(After 7 seconds, the Unit will return to its initial condition.)



- 2. Press the teaching button again.**
Teaching will then begin.
The teaching indicator will remain lit during the teaching operation.



When Teaching Is Successful

The teaching indicator (red) will go out. The Unit will then enter normal operating condition.



When Teaching Is Not Successful

The teaching indicator (red) will flash slowly or quickly.

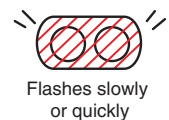

The teaching indicator (red) will then begin flashing even more slowly, indicating that the teaching operation should begin.

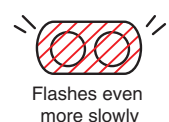

Repeat the operation starting with step 1.

Note: Depending on the amount of light received, the operation indicator and stability indicator may also change during the teaching operation.

Protective measures against aggressive chemicals

The E3ZM family of high grade stainless steel sensors has been designed with the goal to achieve long sensor lifetime in frequently cleaned environments.

High grade SUS 316L housings provide high resistance to aggressive chemicals but the lifetime of a sensor is not only determined by the case material. The design quality is determined by the resistance against detergents of the complete protective structure. When designing a sensor, potential weak points are the material selection and areas where 2 materials connect e.g. the lens, cable entry or the potentiometers. The materials and design structure for the E3ZM have been intensively researched and tested to provide high detergent resistance and sensor lifetime in daily operations compensating for mechanical and temperature stress, high pressure water and aggressive chemicals.

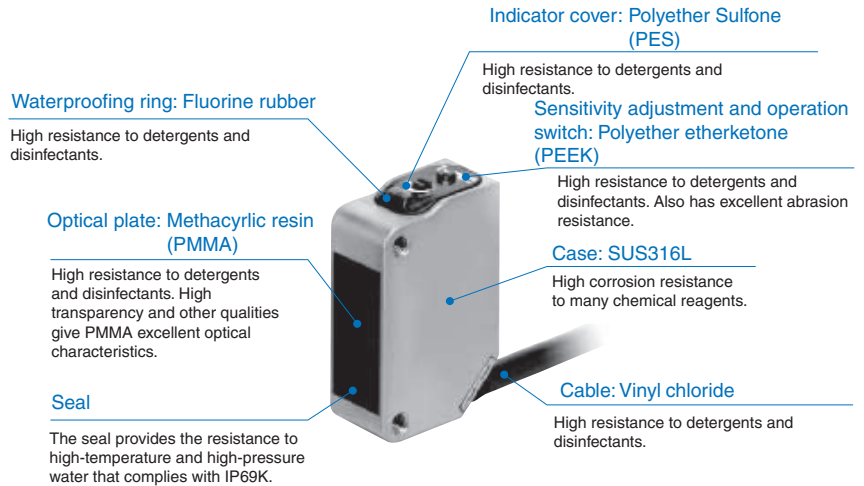

Category	Product name	Concentration	Temperature	Time
Chemical	Sodium hydroxide (NaOH)	1.5%	70°C	240 h
	Potassium hydroxide (KOH)	1.5%	70°C	240 h
	Phosphoric acid (H ₃ PO ₄)	2.5%	70°C	240 h
	Sodium hypochlorite (NaClO)	0.3%	25°C	240 h
	Hydrogen peroxide (H ₂ O ₂)	6.5%	25°C	240 h
Alkaline foam detergent	P3-topax-66s (Manufactured by Ecolab)	3.0%	70°C	240 h
Acidic foam detergent	P3-topax-56 (Manufactured by Ecolab)	5.0%	70°C	240 h
Disinfectant	P3-oxonia active 90 (Manufactured by Ecolab)	1.0%	25°C	240 h
	TEK121 (Manufactured by ABC Compounding)	1.1%	25°C	240 h

Note: The Sensor was immersed in the chemicals, detergents, and disinfectants listed above at the temperatures in the table for 240 hours and then passed an insulation resistance of 100 MΩ min.

Protective measures against water ingress

The family of E3ZM photoelectric sensors is designed and tested for highest protection against water ingress. For achieving the best protection in frequently cleaned environments and to prevent potential errors during installation and operation, refer to the recommendations below.

1. Using pre-wired models

The pre-wired models are manufactured to provide highest protection against water ingress both at the sensor and via the cable.

RECOMMENDATION:

Use pre-wired versions if protection against water ingress is key and frequent replacement of the sensor is not expected



Highest protection

2. Using M8 connector models

Connector models are often preferred to allow an easy exchange of the sensor. When using M8 connector models, observe the recommended mounting torque (see page 10). A too tight connection may damage the sealing ring and a loose connection may provide an opportunity for water to enter into the connection between sensor and connector.

RECOMMENDATION:

To obtain the correct mounting torque, a torque wrench may be used.



Fast exchange

3. Using a M12 or M8 pigtail connector

Using a pigtail cable connector with 30 cm of PVC cable and an M8 or M12 plug combines the highest protection against water ingress of the pre-wired version with the flexibility of the connector models for easy exchanging the sensor.

In general the M12 connectors provide an enhanced protection against installation errors compared to M8 connectors. Additionally the XS5 click connectors always ensure that the correct tightening torque is applied for optimal protection.

RECOMMENDATION:

Use pigtail connectors for the best combination of protection and flexibility for exchanging the sensor.

For ordering pigtail connectors contact your OMRON representative.



Highest protection and fast exchange

Safety Precautions

WARNING

This product is not designed or rated for directly or indirectly ensuring safety of persons. Do not use it for such a purpose.



CAUTION

Do not use the product with voltage in excess of the rated voltage. Excess voltage may result in malfunction or fire.



Never use the product with an AC power supply. Otherwise, explosion may result.



When cleaning the product, do not apply a high-pressure spray of water to one part of the product. Otherwise, parts may become damaged and the degree of protection may be degraded.



Precautions for Safe Use

The following precautions must be observed to ensure safe operation of the Sensor.

Operating Environment

Do not use the Sensor in an environment where explosive or flammable gas is present.

Connecting Connectors

Be sure to hold the connector cover when inserting or removing the connector.

When using an XS3F connector, be sure to tighten the connector lock by hand or preferably with a torque wrench; do not use other tools. If too much tightening torque is applied the degree of protection will not be maintained. If the tightening is insufficient, the degree of protection will not be maintained and the sensor may become loose due to vibration. The appropriate tightening torque is 0.3 to 0.4 N·m.

When using another, commercially available connector, follow the usage and tightening torque instructions provided by the manufacturer.

Load

Do not use a load that exceeds the rated load.

Low-temperature Environments

Do not touch the metal surface with your bare hands when the temperature is low. Touching the surface may result in a cold burn.

Oily Environments

Do not use the Sensor in oily environments. They may damage parts and reduce the degree of protection.

Modifications

Do not attempt to disassemble, repair, or modify the Sensor.

Outdoor Use

Do not use the Sensor in locations subject to direct sunlight.

Cleaning

Do not use thinner, alcohol, or other organic solvents. Otherwise, the optical properties and degree of protection may be degraded.

Cleaning

Do not use highly concentrated cleaning agents. Otherwise, malfunction may result. Also, do not use high-pressure water with a level of pressure that exceeds the stipulated level. Otherwise, the degree of protection may be reduced.

Surface Temperature

Burn injury may occur. The Sensor surface temperature rises depending on application conditions, such as the ambient temperature and the power supply voltage. Use caution when operating or performing maintenance on the Sensor.

Cable Bending

Do not bend the cable in temperatures of -25°C or below. Otherwise, the cable may be damaged.

Dimensions

Note: All units are in millimeters unless otherwise indicated.

Sensors

Pre-wired models

E3ZM-B61
E3ZM-B81

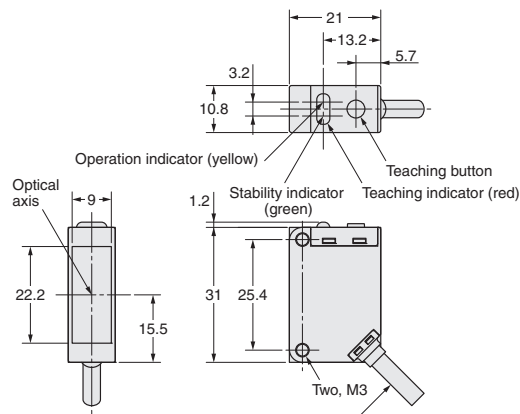

M12 Pre-wired Connector
(E3ZM-□□□-M1J)

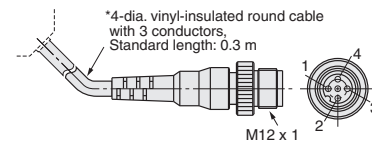

Terminal No.	Specifications
1	+V
2	Operation selection
3	0 V
4	Output

4-dia. Vinyl-insulated round cable with 4 conductors
(Conductor cross section: 0.2 mm² (AWG.24), Insulator diameter: 1.1 mm), Standard length: 2 m

E3ZM-B61T
E3ZM-B81T

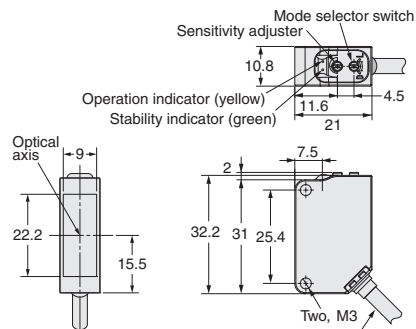

Exemplary pigtail connection
M12 pre-wired connector

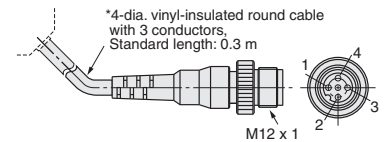

Terminal No.	Specifications
1	+V
2	not connected
3	0 V
4	Output

*4-dia. vinyl-insulated round cable with 3 conductors (Conductor cross section: 0.2 mm², Insulator diameter: 1.1 mm), Standard length: 2 m

M8 connector models

E3ZM-B66
E3ZM-B86

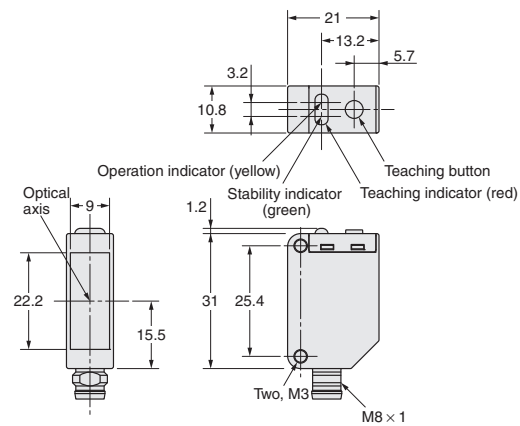

Terminal No.	Specifications
1	+V
2	Operation selection
3	0 V
4	Output

E3ZM-B66T
E3ZM-B86T

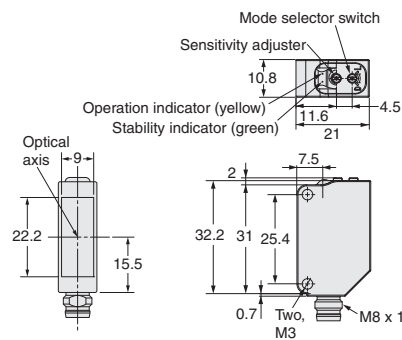

Terminal No.	Specifications
1	+V
2	not connected
3	0 V
4	Output

WARRANTY

OMRON's exclusive warranty is that the products are free from defects in materials and workmanship for a period of one year (or other period if specified) from date of sale by OMRON.

OMRON MAKES NO WARRANTY OR REPRESENTATION, EXPRESS OR IMPLIED, REGARDING NON-INFRINGEMENT, MERCHANTABILITY, OR FITNESS FOR PARTICULAR PURPOSE OF THE PRODUCTS. ANY BUYER OR USER ACKNOWLEDGES THAT THE BUYER OR USER ALONE HAS DETERMINED THAT THE PRODUCTS WILL SUITABLY MEET THE REQUIREMENTS OF THEIR INTENDED USE. OMRON DISCLAIMS ALL OTHER WARRANTIES, EXPRESS OR IMPLIED.

LIMITATIONS OF LIABILITY

OMRON SHALL NOT BE RESPONSIBLE FOR SPECIAL, INDIRECT, OR CONSEQUENTIAL DAMAGES, LOSS OF PROFITS OR COMMERCIAL LOSS IN ANY WAY CONNECTED WITH THE PRODUCTS, WHETHER SUCH CLAIM IS BASED ON CONTRACT, WARRANTY, NEGLIGENCE, OR STRICT LIABILITY.

In no event shall responsibility of OMRON for any act exceed the individual price of the product on which liability is asserted.

IN NO EVENT SHALL OMRON BE RESPONSIBLE FOR WARRANTY, REPAIR, OR OTHER CLAIMS REGARDING THE PRODUCTS UNLESS OMRON'S ANALYSIS CONFIRMS THAT THE PRODUCTS WERE PROPERLY HANDLED, STORED, INSTALLED, AND MAINTAINED AND NOT SUBJECT TO CONTAMINATION, ABUSE, MISUSE, OR INAPPROPRIATE MODIFICATION OR REPAIR.

SUITABILITY FOR USE

THE PRODUCTS CONTAINED IN THIS DOCUMENT ARE NOT SAFETY RATED. THEY ARE NOT DESIGNED OR RATED FOR ENSURING SAFETY OF PERSONS, AND SHOULD NOT BE RELIED UPON AS A SAFETY COMPONENT OR PROTECTIVE DEVICE FOR SUCH PURPOSES. Please refer to separate catalogs for OMRON's safety rated products.

OMRON shall not be responsible for conformity with any standards, codes, or regulations that apply to the combination of products in the customer's application or use of the product.

At the customer's request, OMRON will provide applicable third party certification documents identifying ratings and limitations of use that apply to the products. This information by itself is not sufficient for a complete determination of the suitability of the products in combination with the end product, machine, system, or other application or use.

The following are some examples of applications for which particular attention must be given. This is not intended to be an exhaustive list of all possible uses of the products, nor is it intended to imply that the uses listed may be suitable for the products:

- Outdoor use, uses involving potential chemical contamination or electrical interference, or conditions or uses not described in this document.
- Nuclear energy control systems, combustion systems, railroad systems, aviation systems, medical equipment, amusement machines, vehicles, safety equipment, and installations subject to separate industry or government regulations.
- Systems, machines, and equipment that could present a risk to life or property.

Please know and observe all prohibitions of use applicable to the products.

NEVER USE THE PRODUCTS FOR AN APPLICATION INVOLVING SERIOUS RISK TO LIFE OR PROPERTY WITHOUT ENSURING THAT THE SYSTEM AS A WHOLE HAS BEEN DESIGNED TO ADDRESS THE RISKS, AND THAT THE OMRON PRODUCT IS PROPERLY RATED AND INSTALLED FOR THE INTENDED USE WITHIN THE OVERALL EQUIPMENT OR SYSTEM.

PERFORMANCE DATA

Performance data given in this document is provided as a guide for the user in determining suitability and does not constitute a warranty. It may represent the result of OMRON's test conditions, and the users must correlate it to actual application requirements. Actual performance is subject to the OMRON Warranty and Limitations of Liability.

CHANGE IN SPECIFICATIONS

Product specifications and accessories may be changed at any time based on improvements and other reasons.

It is our practice to change model numbers when published ratings or features are changed, or when significant construction changes are made. However, some specifications of the product may be changed without any notice. When in doubt, special model numbers may be assigned to fix or establish key specifications for your application on your request. Please consult with your OMRON representative at any time to confirm actual specifications of purchased products.

DIMENSIONS AND WEIGHTS

Dimensions and weights are nominal and are not to be used for manufacturing purposes, even when tolerances are shown.

ERRORS AND OMISSIONS

The information in this document has been carefully checked and is believed to be accurate; however, no responsibility is assumed for clerical, typographical, or proofreading errors, or omissions.

PROGRAMMABLE PRODUCTS

OMRON shall not be responsible for the user's programming of a programmable product, or any consequence thereof.

Cat. No. E385-E2-01-X

In the interest of product improvement, specifications are subject to change without notice.

OMRON EUROPE B.V.

Wegalaan 67-69,
 NL-2132 JD, Hoofddorp,
 The Netherlands
 Phone: +31 23 568 13 00
 Fax: +31 23 568 13 88
 www.industrial.omron.eu