

DLH DG 8 H32 FG180.280 KK V2A (206 819)

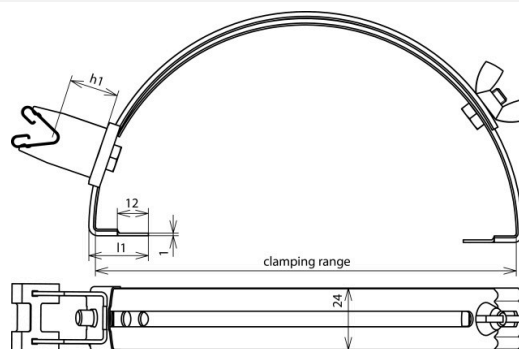

Figure without obligation



Type	DLH DG 8 H32 FG180.280 KK V2A
Part No.	206 819
Material of roof conductor holder	StSt
Clamping range	180-280 mm
Height of conductor holder (h1)	32 mm
Material of conductor holder	StSt
Conductor support Rd	8 mm
Length of clamping claw	15 mm
Type of conductor holder	DEHNgrip
Conductor routing	loose
Female thread	M6
Standard	EN 62561-4
Weight	115 g
Customs tariff number	85389099
GTIN	4013364077362
PU	25 Stk

We reserve the right to introduce changes in performance, configuration and technology, dimensions, weights and materials in the course of technical progress. The figures are shown without obligation.