

# Product Data Sheet

## DX43416

RK Range



Routing components for rigid protective conduits with IP40 and IP67 protection degree.

Colour	Grey RAL 7035	IP degree	IP65
Conduits Ø (mm)	16	Sheath Ø (mm)	16
Type of material	Halogen-free in compliance with EN 60754-2	Electrocod	21221

### DIMENSIONAL

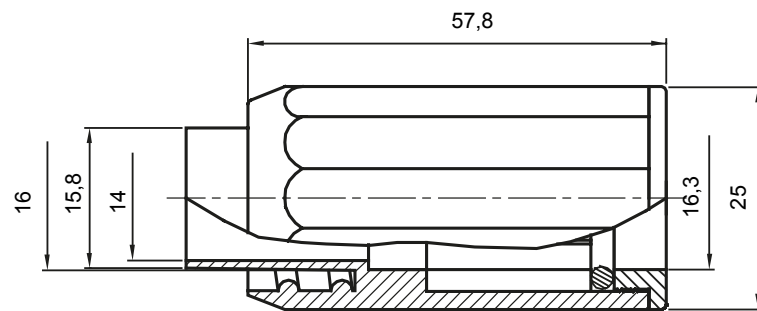
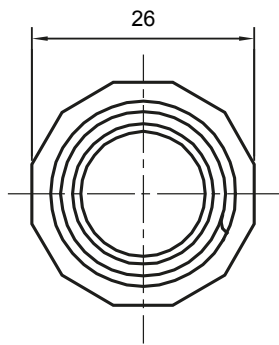

### TECHNICAL SYMBOLOGY

IP

HF  
HALOGEN FREE

IP65

### STANDARDS/APPROVALS

