

# Product Data Sheet

## DX52120

FK Range

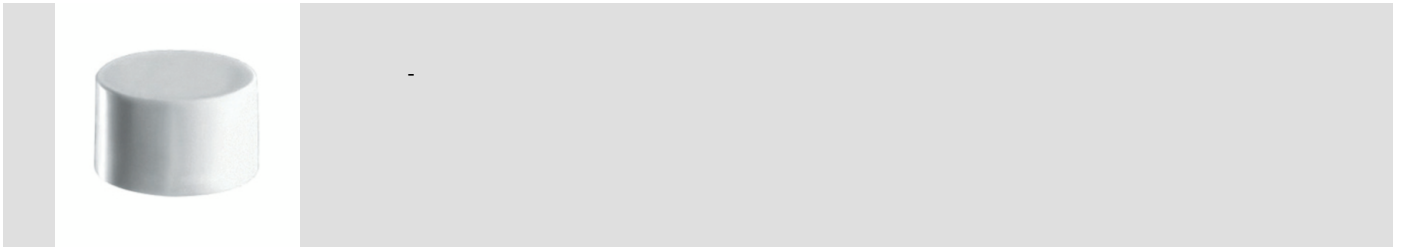

Colour	Grey RAL 7035	Material	PP
Conduits Ø (mm)	20	Electrocod	210

### DIMENSIONAL

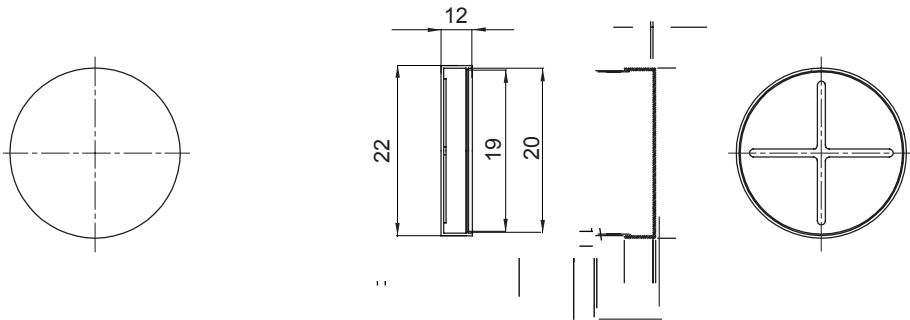

### STANDARDS/APPROVALS

