

TeSys U DTM for FDT Container Online Help

01/2020



The information provided in this documentation contains general descriptions and/or technical characteristics of the performance of the products contained herein. This documentation is not intended as a substitute for and is not to be used for determining suitability or reliability of these products for specific user applications. It is the duty of any such user or integrator to perform the appropriate and complete risk analysis, evaluation and testing of the products with respect to the relevant specific application or use thereof. Neither Schneider Electric nor any of its affiliates or subsidiaries shall be responsible or liable for misuse of the information that is contained herein. If you have any suggestions for improvements or amendments or have found errors in this publication, please notify us.

No part of this document may be reproduced in any form or by any means, electronic or mechanical, including photocopying, without express written permission of Schneider Electric.

All pertinent state, regional, and local safety regulations must be observed when installing and using this product. For reasons of safety and to help ensure compliance with documented system data, only the manufacturer should perform repairs to components.

When devices are used for applications with technical safety requirements, the relevant instructions must be followed.

Failure to use Schneider Electric software or approved software with our hardware products may result in injury, harm, or improper operating results.

Failure to observe this information can result in injury or equipment damage.

© 2020 Schneider Electric. All rights reserved.

Table of Contents



	Safety Information	5
	About the Book	7
Chapter 1	Presentation of the TeSys U DTM	9
1.1	Introduction	10
	Presentation of the TeSys U Starter-Controller	11
	TeSys U Selection Guide	16
	Definitions	18
	Installing SoMove and the TeSys DTM Library	19
	Installing Update TeSys DTM Library	20
	Hardware Connection for SoMove	21
1.2	User Interface	22
	General Description	23
	Menu Bar and Tool Bar	25
	Status Bar and Synchronization Data Bar	26
	my Device Tab	29
	operate Tab	30
	Tab Zone	32
	parameter list Tab	35
	fault Tab	37
	monitoring Tab	38
	diagnostic Tab	41
Chapter 2	Metering and Monitoring Functions	43
2.1	Measurement	44
	Line Currents	45
	Ground Current	46
	Average Current	47
	Current Phase Imbalance	48
	Thermal Capacity Level	49
	Minimum Wait Time	50
2.2	Device Monitoring Faults	51
	TeSys U Internal Faults	52
	LUCM Internal Temperature	53
	Wiring Faults	54
	Communication Loss	55
	Shunt Fault Command	57
2.3	Statistics	58
	Fault and Warning Counters	59
	Fault History	60
	Motor Statistics	61
Chapter 3	Motor Protection Functions	63
	Motor Protection Characteristics	64
	FLA (Full Load Amps) Settings	65
	Thermal Overload	66
	Short-Circuit	69
	Magnetic	70
	Ground Current	71
	Current Phase Imbalance	73
	Long Start	76
	Jam	78
	Undercurrent	80

Chapter 4	Motor Control Functions	83
	Operating States	84
	Start Cycle	86
	Logic Output Assignment	87
	Recovery Mode	89
	Reflex Stop Functions	90
	Warning Management	92
	Detected Fault Management	93
	Clear Commands	96
Chapter 5	Communication Functions	97
	Configuration of the LULC•• Network Port	98
	Configuration of the Tesys U LUCM HMI Port	100
Index	101



Important Information

NOTICE

Read these instructions carefully, and look at the equipment to become familiar with the device before trying to install, operate, or maintain it. The following special messages may appear throughout this documentation or on the equipment to warn of potential hazards or to call attention to information that clarifies or simplifies a procedure.



The addition of this symbol to a Danger safety label indicates that an electrical hazard exists, which will result in personal injury if the instructions are not followed.



This is the safety alert symbol. It is used to alert you to potential personal injury hazards. Obey all safety messages that follow this symbol to avoid possible injury or death.

DANGER

DANGER indicates an imminently hazardous situation which, if not avoided, **will result in** death or serious injury.

WARNING

WARNING indicates a potentially hazardous situation which, if not avoided, **can result in** death or serious injury.

CAUTION

CAUTION indicates a potentially hazardous situation which, if not avoided, **can result in** minor or moderate injury.

NOTICE

NOTICE is used to address practices not related to physical injury.

PLEASE NOTE

Electrical equipment should be installed, operated, serviced, and maintained only by qualified personnel. No responsibility is assumed by Schneider Electric for any consequences arising out of the use of this material.

A qualified person is one who has skills and knowledge related to the construction and operation of electrical equipment and its installation, and has received safety training to recognize and avoid the hazards involved.

About the Book



At a Glance

Document Scope

This online help describes:

- the TeSys U DTM for TeSys U starter-controllers up to 18.5 kW (25 hp)
- the metering and monitoring, protection, and control functions of the TeSys U starter-controllers

This online help is intended for TeSys U DTM users:

- design engineers
- system integrators
- system operators
- maintenance engineers

Validity Note

This document has been updated with the release of SoMove Lite V1.6.1.1 and TeSys DTM library 2.7.4.0. The availability of some functions depends on the TeSys U starter-controller version.

Related Documents

Title of Documentation	Reference Number
TeSys U LUCM/LUCMT Multifunction Control Units - User's Manual	1743237
TeSys U Communication Variables - User's Manual	1744082
TeSys U LULC032-LULC033 Modbus Module - User's Manual	1743234
TeSys U LULC07 Profibus DP Module - User's Manual	1672610
TeSys U LULC08 CANopen Module - User's Manual	1744084
TeSys U LULC09 DeviceNet Module - User's Manual	1744085
TeSys U LULC15 Advantys STB Module - User's Manual	1744083

You can download these technical publications and other technical information from our website at <https://www.se.com/ww/en/download/>.

Chapter 1

Presentation of the TeSys U DTM

What Is in This Chapter?

This chapter contains the following sections:

Section	Topic	Page
1.1	Introduction	10
1.2	User Interface	22

Section 1.1

Introduction

Overview

This section describes the prerequisites for using the TeSys U starter-controller and companion devices with SoMove and the TeSys U DTM.

What Is in This Section?

This section contains the following topics:

Topic	Page
Presentation of the TeSys U Starter-Controller	11
TeSys U Selection Guide	16
Definitions	18
Installing SoMove and the TeSys DTM Library	19
Installing Update TeSys DTM Library	20
Hardware Connection for SoMove	21

Presentation of the TeSys U Starter-Controller

Overview

The TeSys U starter-controller is a Direct On Line starter for use with inductive loads (control of DC or capacitive loads is not possible). The TeSys U starter-controller performs the following functions:

- Protection and control of single-phase or 3-phase motors:
 - isolation and breaking function
 - overload and short-circuit protection
 - thermal overload protection
 - power switching
- Control of the application:
 - protection function alarms, application monitoring (running time, number of faults, motor current values, etc.)
 - logs (last 5 faults saved, together with motor parameter values)

These functions can be added by selecting control units and function modules which simply clip into the power base. This customization is possible after power and control circuit wiring has been completed.

TeSys U is a flexible range that meets the current and future needs of system builders, panel builders and machine manufacturers, as well as those of additional systems.

From design through to operation, TeSys U offers many advantages and simplifies the selection of components in comparison with a traditional solution:

- The breaking, isolation and contactor functions are incorporated in a single block; this means fewer references to be ordered and easy selection without any risk of error, because a single reference covers all needs up to 18.5 kW (25 hp).
- The control unit has a wide setting range. It can operate on a DC or AC supply.

The number of references required is divided by 10, compared with traditional solutions.

The compact components in the TeSys U range are mounted on a single rail, in order to optimizing the amount of space required in enclosures. By eliminating power wiring between the circuit-breaker and contactor, TeSys U reduces installation times in enclosures.

Setting-up accessories simplify or completely eliminate wiring between components and decrease the risk of errors.

TeSys U Starter-Controller

A TeSys U starter-controller consists of a power base and a control unit.

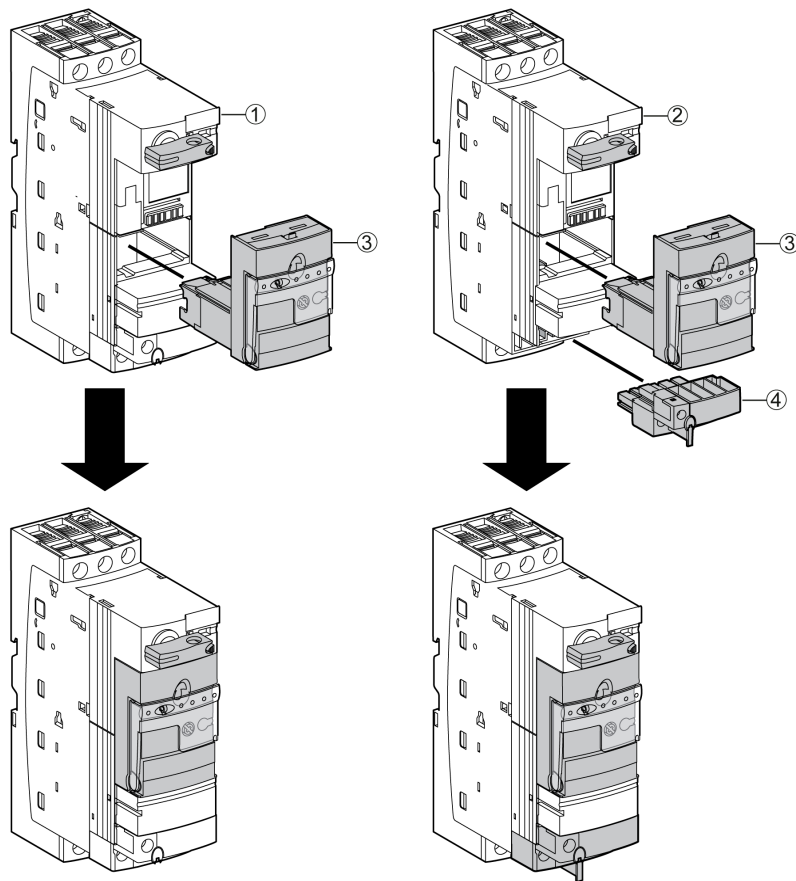

- 1 Power base LUB** with embedded non-removable auxiliary contact block
- 2 Power base LUB**0 without auxiliary contacts
- 3 Control unit LUC**
- 4 Optional auxiliary contact block LU9BN11, LU9BN11C or LU9BN11L

Power Base

The power base is independent of the control voltage.

It is available from 0 to 18.5 kW (25 hp) at 400 Vac.

It incorporates the breaking function with a breaking capacity of 50 kA at 400 Vac, total coordination (continuity of service) and the switching function.

3 ratings are available:

- 0...12 A
- 0...32 A
- 0...38 A

It can be non-reversing (LUB) and reversing (LU2B).

2 types of power bases are available:

- LUB** power bases with embedded non-removable auxiliary contact block (1 NO + 1 NC).
- LUB**0 power bases without auxiliary contact block. The following optional auxiliary contact blocks should be added to the power bases:
 - LU9BN11: coil control + 1 NO + 1 NC
 - LU9BN11C: direct link to LUFC00, LULC033 or ASILUFC51 modules for coil control + 1 NO + 1 NC
 - LU9BN11L: direct link to LULC07, LULC08, LULC09, or LULC15 modules for coil control + 1 NO + 1 NC

Control Unit

The control unit must be selected according to the control voltage, the power of the motor to be protected and the type of protection required.

To obtain the comprehensive control unit reference number, the generic characters ** must be replaced by the relevant reference code. Refer to the *TeSys U starter-controllers catalogue*.

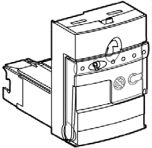
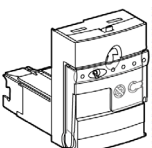
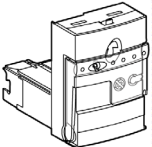
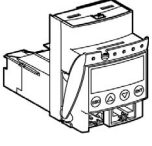
Control Unit	Functional Description	Reference
Standard Thermal magnetic protection 	Satisfies the basic protection requirements for motor starters: <ul style="list-style-type: none"> ● protection against overloads and short-circuits ● protection against phase failure and phase imbalance ● earth fault protection (equipment protection only) ● manual reset 	LUCA**
Standard Magnetic protection 	When fitted upstream of a variable speed drive or soft start-soft stop unit and used in conjunction with an LUB** or LUB**0 power base, this unit provides isolation and short-circuit protection of the motor starter: <ul style="list-style-type: none"> ● protection against short-circuits ● manual reset 	LUCL**
Advanced 	Allows additional advanced functions such as alarm, fault differentiation: <ul style="list-style-type: none"> ● same functions as the standard control unit ● in addition, in conjunction with a function module: <ul style="list-style-type: none"> ○ fault differentiation with manual reset ○ fault differentiation with remote or automatic reset ○ thermal overload alarm ○ indication of motor load 	LUCB**, LUCC** or LUCD**
Multifunction ⁽¹⁾ 	Suitable for the most sophisticated control and protection requirements: <ul style="list-style-type: none"> ● same functions as the standard control unit ● in addition, reset parameters can be set to manual or automatic ● protection function alarm ● indication on front panel or on remote terminal via Modbus RS 485 port ● log function ● monitoring function, indication of main motor parameters on front panel of the control unit, or via a remote terminal ● differentiation of thermal overload and magnetic fault ● overload, no-load running 	LUCM**
(1) Applicable for rating 0...32 A only.		

The control units are interchangeable without rewiring and without using tools.

They have a wide range of adjustment (range of 4) and low heat dissipation, because bimetallic overload protection components are no longer used.

Control Options

1 optional control module can be used to increase the functions of the TeSys U starter-controller.

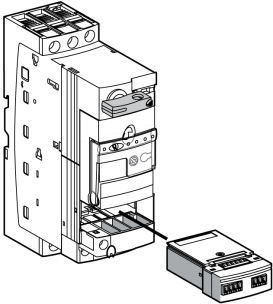
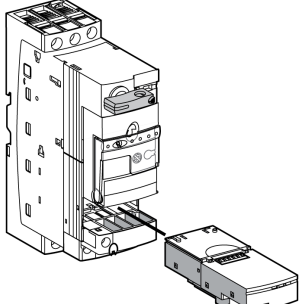
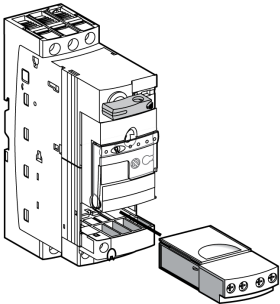
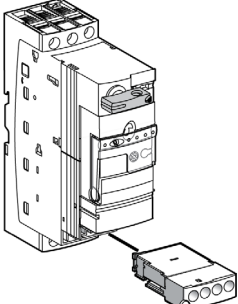
TeSys U Starter-Controller with Control Option	Control Option	Functional Description
	Function modules	<p>Must be used in conjunction with advanced control units. 4 types are available:</p> <ul style="list-style-type: none"> ● thermal overload alarm (LUFW10) ● thermal fault and manual reset (LUFDH11) ● thermal fault and automatic or remote reset (LUFDA01 and LUFDA10) ● indication of motor load (LUFV2), which can also be used in conjunction with the multifunction control unit <p>All alarm and fault information processed by these modules is available on digital contacts.</p>
	Communication modules	<p>The information processed is exchanged:</p> <ul style="list-style-type: none"> ● via a parallel bus: <ul style="list-style-type: none"> ○ parallel wiring module (LUFC00) ● via a serial bus: <ul style="list-style-type: none"> ○ AS-Interface modules (ASILUFC51) ○ Profibus DP module (LULC07) ○ CANopen module (LULC08) ○ DeviceNet module (LULC09) ○ Advantys STB module (LULC15) ○ Modbus modules (LULC033) <p>They must:</p> <ul style="list-style-type: none"> ● be used in conjunction with a 24 Vdc control unit, and ● require a 24 Vdc supply voltage. <p>Connection to other protocols, such as Fipio, is possible via gateway modules (LUFPP) or via the TeSysPort for Ethernet.</p>
	Auxiliary contact modules	<p>3 possible configurations:</p> <ul style="list-style-type: none"> ● 2 NO (LUFN20) ● 1 NO + 1 NC (LUFN11) ● 2 NC (LUFN02)
	Auxiliary contacts	<p>They provide the following information:</p> <ul style="list-style-type: none"> ● fault signaling (LUA1C11) ● rotary knob in ready position (LUA1C20)

Power Options

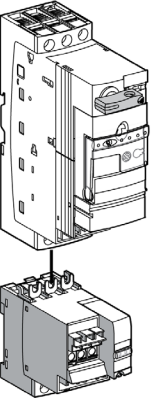
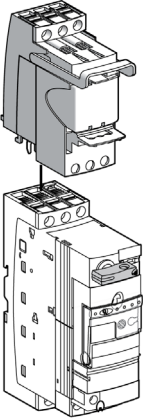
TeSys U Starter-Controller with Power Option	Power Option	Functional Description
	Reverser block	<p>Allows a non-reversing power base to be converted to reversing operation:</p> <ul style="list-style-type: none"> • The reverser block LU2M is mounted directly beneath the power base without modifying the width of the product (45 mm or 1.77 in.), • The reverser block LU6M is mounted separately from the power base when the height available is limited.
	Limiter-disconnector	<p>The unit (LUALB) is mounted directly on the power base. It allows the breaking capacity to be increased up to 130 kA at 400 Vac, with a visible break.</p>

TeSys U Selection Guide

Overview

The functions performed by the TeSys U starter-controller depend on the type of LUC• control unit used (standard, advanced or multifunction).

The addition of an optional LULC•• communication module increases the control and monitoring functions of the TeSys U starter-controller.

Selection Guide

The table below indicates the control, protection, metering, and monitoring functions available according to the TeSys U hardware configuration using the legend as follows:

X Function available with or without optional communication module LULC••

√ Function available only with communication module LULC••

– Function not available

Function	Type of Function	Standard Control Unit LUCL	Standard Control Unit LUCA	Advanced Control Unit LUCB, LUCC, or LUCD	Multifunction Control Unit LUCM
Short-circuit (<i>see page 69</i>)	Protection	X	X	X	X
Magnetic (<i>see page 70</i>)	Protection	X	X	X	X
Clear commands (<i>see page 96</i>)	Control	√	√	√	X
Start and Stop commands	Control	√	√	√	√
Recovery mode (<i>see page 89</i>)	Control	√	√	√	√
Reflex stop (<i>see page 90</i>)	Control	√	√	√	√
Logic output assignment (<i>see page 87</i>)	Control	√	√	√	√
Communication loss (<i>see page 55</i>)	Monitoring	√	√	√	X
Thermal overload (<i>see page 66</i>)	Protection	–	X	X	X
Automatic and Remote reset (<i>see page 93</i>)	Control	–	–	√	√
Starter status (ready, running, fault) (<i>see page 84</i>)	Control	–	–	√	√
Thermal capacity level (<i>see page 49</i>)	Metering	–	–	√	X
Average current ratio (<i>see page 47</i>)	Metering	–	–	√	X
TeSys U internal faults (<i>see page 52</i>)	Monitoring	–	–	√	X
Shunt fault command (<i>see page 57</i>)	Monitoring	–	–	√	X
Fault signaling and differentiation	Monitoring	–	–	√	X
Ground current (<i>see page 71</i>)	Protection	–	–	–	X
Current phase imbalance (<i>see page 73</i>)	Protection	–	–	–	X
Long start (<i>see page 76</i>)	Protection	–	–	–	X
Jam (<i>see page 78</i>)	Protection	–	–	–	X
Undercurrent (<i>see page 80</i>)	Protection	–	–	–	X
Line current ratio (<i>see page 45</i>)	Metering	–	–	–	X
Line current (<i>see page 45</i>)	Metering	–	–	–	X
Ground current ratio (<i>see page 46</i>)	Metering	–	–	–	X
Ground current (<i>see page 46</i>)	Metering	–	–	–	X
Average current (<i>see page 47</i>)	Metering	–	–	–	X
Current phase imbalance (<i>see page 48</i>)	Metering	–	–	–	X
Minimum wait time (<i>see page 50</i>)	Metering	–	–	–	X

Function	Type of Function	Standard Control Unit LUCL	Standard Control Unit LUCA	Advanced Control Unit LUCB, LUCC, or LUCD	Multifunction Control Unit LUCM
LUCM internal temperature <i>(see page 53)</i>	Monitoring	–	–	–	X
Wiring faults <i>(see page 54)</i>	Monitoring	–	–	–	X
Fault and warning counters <i>(see page 59)</i>	Monitoring	–	–	–	X
Fault history <i>(see page 60)</i>	Monitoring	–	–	–	X
Motor statistics <i>(see page 61)</i>	Monitoring	–	–	–	X
Remote setting and monitoring of all functions	Monitoring	–	–	–	√

Definitions

FDT (Field Device Tool)

FDT technology:

- standardizes the communication and configuration interface between all field devices and host systems
- provides a common environment for accessing the devices features

For more information about FDT technology, refer to the following website:

<http://www.fdtgroup.org/index.php>

FDT Container

The FDT container is software that uses the FDT technology. It is used to:

- install a DTM library to add new devices
- modify an already installed DTM library to update existing devices

DTM (Device Type Manager)

The DTM is a software module installed in an FDT container for a specific device. It provides a unified structure for:

- accessing device parameters
- configuring and operating the devices
- diagnosing problems

The TeSys T or TeSys U DTM can be in extended mode or in basic mode, depending on the FDT container used:

- The extended mode is only available with SoMove, and gives access to all functions of the DTM.
- The basic mode is available with other compatible FDT containers, and gives access to certain functions of the DTM.

DTM Library

A DTM library is a set of DTMs that works with an FDT container.

The TeSys DTM library includes:

- TeSys T DTM
- TeSys U DTM

SoMove Project File

A SoMove project file is a configuration file for a pre-determined device, that can be created offline and saved for later use.

A project file contains the following information:

- device type
- selected characteristics, such as firmware version
- all parameters settings

NOTE:

- The project file does not contain the customized program.
- This file is saved with the extension **.psx*.

For more information on how to create a project, see the *SoMove online help*.

Installing SoMove and the TeSys DTM Library

Overview

The installation of SoMove includes some DTMs such as the TeSys DTM library.

The TeSys DTM library includes:

- TeSys T DTM
- TeSys U DTM

These DTM are automatically installed during the SoMove installation process.

Downloading SoMove

SoMove can be downloaded from the Schneider Electric website (www.se.com) by entering SoMove in the **Search** field.

Installing SoMove

Step	Action
1	Unzip the downloaded file: the SoMove file is unzipped in a folder named <i>SoMove - V.X.X.X</i> (where X.X.X is the version number). Open this folder and double-click setup.exe .
2	In the Choose Setup Language dialog box, select the installation language.
3	Click OK .
4	In the Welcome to the Installation Wizard for SoMove dialog box, click the Next button.
5	If an Install Shield Wizard dialog box appears and informs you that you must install Modbus driver, click the Install button. Result: Modbus driver is installed automatically.
6	In the Readme and Release Notes dialog box, click the Next button.
7	In the Readme dialog box, click the Next button.
8	In the License Agreement dialog box: <ul style="list-style-type: none"> ● Read carefully the license agreement. ● Select I accept the terms in the license agreement option. ● Click the Next button.
9	In the Customer Information dialog box: <ul style="list-style-type: none"> ● Enter the following information in the corresponding fields: <ul style="list-style-type: none"> ○ First name ○ Last name ○ Company name ● Select an installation option: <ul style="list-style-type: none"> ○ Either the Anyone who uses this computer option if SoMove is used by all users of this computer, or ○ Only for me if SoMove is used only by you. ● Click the Next button.
10	In the Destination Folder dialog box: <ul style="list-style-type: none"> ● If necessary, modify the SoMove destination folder by clicking the Change button. ● Click the Next button.
11	In the Shortcuts dialog box: <ul style="list-style-type: none"> ● If you want to create a shortcut on the desktop and/or in the quick launch bar, select the corresponding options. ● Click the Next button.
12	In the Ready to Install the Program dialog box, click the Install button. Result: The SoMove components are installed automatically: <ul style="list-style-type: none"> ● Modbus communication DTM library which contains the communication protocol ● DTM libraries which contain different drive catalogs ● SoMove itself
13	In the Installation Wizard Completed dialog box, click the Finish button. Result: SoMove is installed on your computer.

Installing Update TeSys DTM Library

Overview

The TeSys DTM library includes:

- TeSys T DTM
- TeSys U DTM

These DTM are automatically installed during the SoMove installation process.

Downloading TeSysDTMLibrary

TeSysDTMLibrary can be downloaded from the Schneider Electric website (www.se.com) by entering TeSysDTMLibrary in the **Search** field.

Installing Update TeSys DTM Library

Step	Action
1	Unzip the downloaded file. Open this folder and double-click setup.exe . The TeSysDTMLibrary file is unzipped in a folder named <i>TeSysDTMLibrary - V.X.X.X.X</i> (where X.X.X.X is the version number).
2	In the Choose Setup Language dialog box, select the installation language.
3	Click OK .
4	In the Welcome to the Installation Wizard for TeSysDTMLibrary dialog box, click the Next button.
5	In the Readme and Release Notes dialog box, click the Next button.
6	In the License Agreement dialog box: <ul style="list-style-type: none"> ● Read carefully the license agreement. ● Select I accept the terms in the license agreement option. ● Click the Next button.
7	In the Customer Information dialog box: <ul style="list-style-type: none"> ● Enter the following information in the corresponding fields: <ul style="list-style-type: none"> ○ First name ○ Last name ○ Company name ● Select an installation option: <ul style="list-style-type: none"> ○ Either the Anyone who uses this computer option if TeSys DTM library is used by all users of this computer, or ○ Only for me if TeSys DTM library is used only by you. ● Click the Next button.
8	In the Destination Folder dialog box: <ul style="list-style-type: none"> ● If necessary, modify the TeSys DTM library destination folder by clicking the Change button. ● Click the Next button.
9	In the Setup Type dialog box: <ul style="list-style-type: none"> ● Select the setup type: recommended Typical. ● Click the Next button.
10	In the Ready to Install the Program dialog box, click the Install button. Result: The TeSys DTM library components are installed automatically.
11	In the Installation Wizard Completed dialog box, click the Finish button. Result: The TeSys DTM library is installed on your computer.

Hardware Connection for SoMove

Overview

This section describes how to physically connect the TeSys U starter-controller to a PC running SoMove with the TeSys U DTM.

The PC requires its own power source and must be connected to the RJ45 port on the TeSys U starter-controller.

The PC have to be connected in a 1-to-1 configuration to a single TeSys U starter-controller.

Connecting to a PC Running SoMove with the TeSys U DTM in 1-to-1 Mode

The diagram below shows a 1-to-1 connection from a PC running SoMove with the TeSys U DTM to the TeSys U starter-controller.

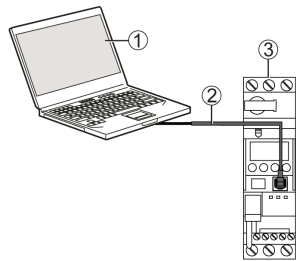

- 1 PC running SoMove with the TeSys U DTM
- 2 Cable kit TCSMCNAM3M002P
- 3 TeSys U starter-controller

Connection Accessories

The following table details the connection accessory:

Designation	Description	Reference
Cable kit	Length = 2.5 m (8.2 ft) USB to RS-485 converter	TCSMCNAM3M002P

Section 1.2

User Interface

Overview

This section describes the different menus and tabs available in SoMove with the TeSys U DTM.

What Is in This Section?

This section contains the following topics:

Topic	Page
General Description	23
Menu Bar and Tool Bar	25
Status Bar and Synchronization Data Bar	26
my Device Tab	29
operate Tab	30
Tab Zone	32
parameter list Tab	35
fault Tab	37
monitoring Tab	38
diagnostic Tab	41

General Description

Overview

The TeSys U DTM can be in extended mode or in basic mode, depending on the FDT container used:

- The extended mode is only available with SoMove, and gives access to all functions of the DTM.
- The basic mode is available with other compatible FDT containers, and gives access to certain functions of the DTM.

Extended Mode Presentation

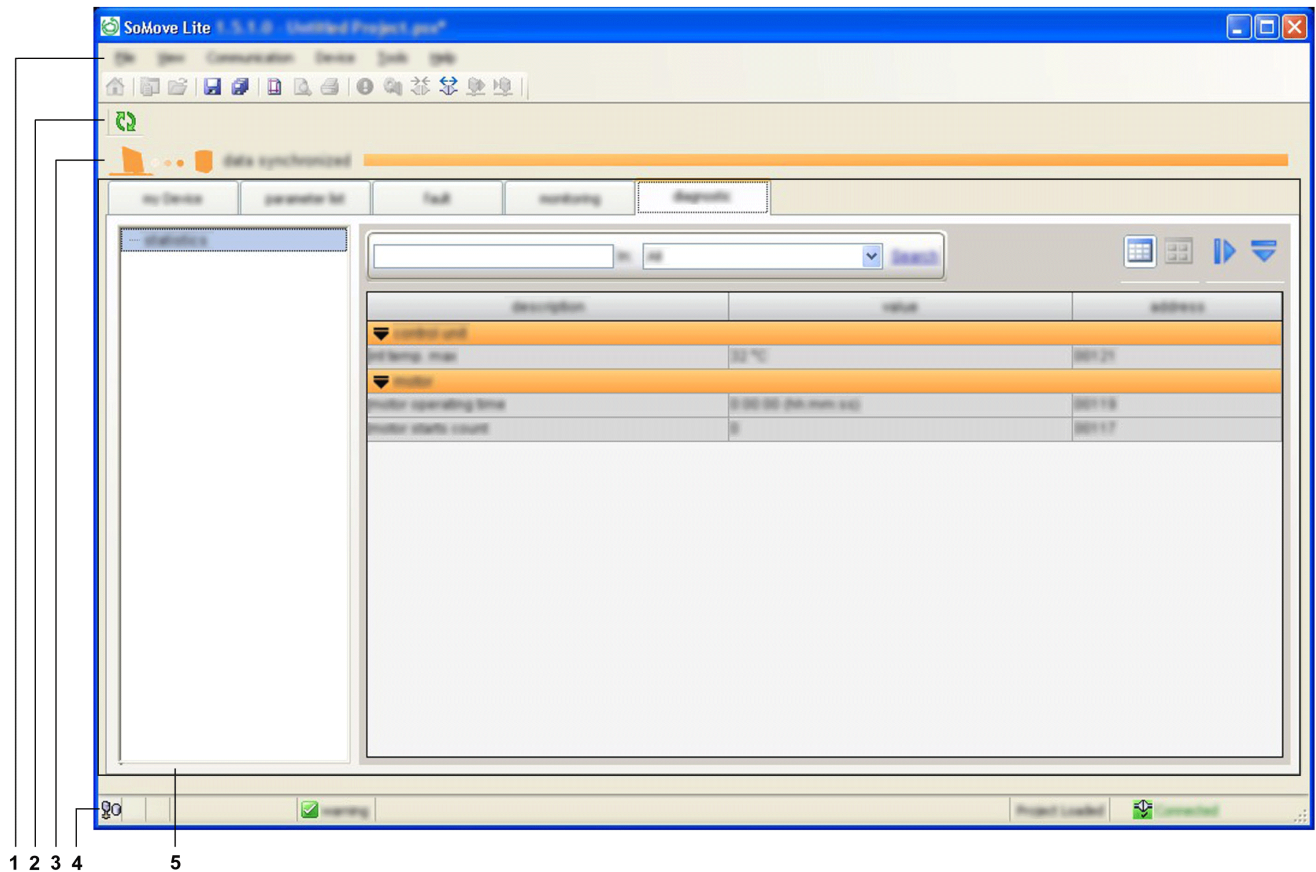

The working space is divided into the following zones:

- 1 menu bar (*see page 25*)
- 2 tool bar (*see page 25*)
- 3 synchronization data area (*see page 26*)
- 4 status bar (*see page 26*)
- 5 tab zone (content depending on the selected tab)

Basic Mode Presentation

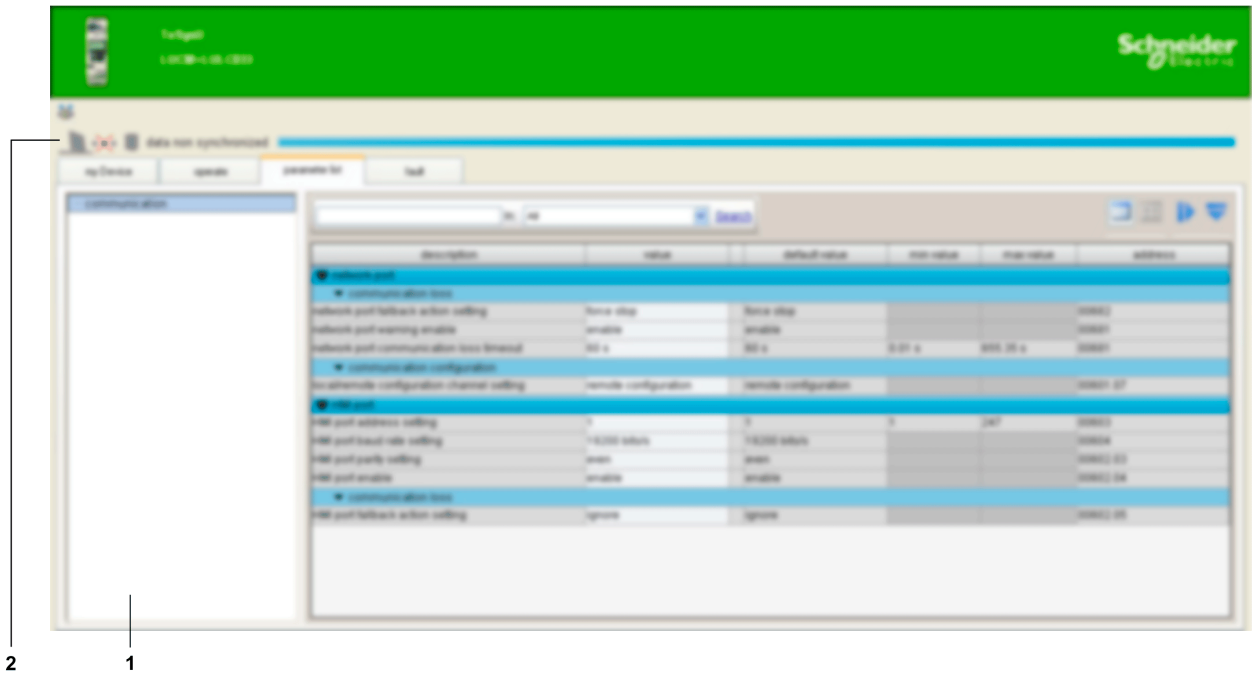

The working space is divided into the following zones:
 1 tab zone (content depending on the selected tab)
 2 synchronization data area (see page 26)

Tab Zone

The table below shows the tab zone available for the basic mode and extended mode.

Tab Name	Description	Basic Mode	Extended Mode
my Device	Tab displays the device modules and characteristics tab (see page 29)	XX	XX
operate	Tab displays the operate data tab (see page 30)	XX	XX
parameter list	Tabs display the TeSys U starter-controller parameters and status	X	XX
fault		XX	XX
monitoring		-	XX
diagnostic		-	XX
- Not available X Available with restrictions XX Available without restrictions			

Menu Bar and Tool Bar

Menu Bar

These functions are available with the extended mode using SoMove. The menu bar, at the top of the working space, is represented below:

File View Communication Device Tools Help

Only the functions specific to the TeSys U starter-controller are described here:

- **Device** menu that contains the TeSys U DTM specific functions (available in connected mode only).
- **File** menu where the SoMove **Configuration Recovery** function is adapted to the TeSys U DTM.

Other menus are generic and are described in the *SoMove online help*.

Tool Bar

The tool bar, at the top of the working space directly beneath the menu bar, is specific to the DTM:

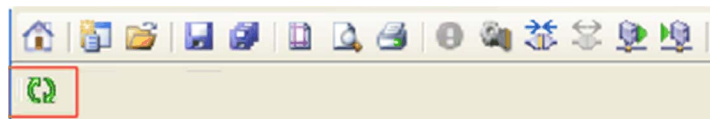

The buttons of the tool bar enable the user to directly access the main functions without using the menu bar.

The tool bar Refresh button  is used to refresh all parameters from the connected TeSys U starter-controller.

Device Menu in the Connected Mode

Submenu	Function	Description
Reset (<i>see page 93</i>)	fault reset	Resets detected faults
clear (<i>see page 96</i>)	clear all	Erases all parameters (history, statistics, network, etc.) except the LUCM internal temperature max parameters
	clear statistics	Erases statistics except the LUCM internal temperature max parameters
	clear Th capa level	Erases thermal information to bypass a thermal fault for emergency restart (<i>see page 66</i>)
Maintenance	Th overload test	Simulates a thermal fault
	shunt	Simulates a short-circuit (<i>see page 57</i>)

Configuration Recovery

The Configuration Recovery function allows loading a PowerSuite 2 project file using the TeSys U DTM in SoMove.

Step	Action
1	Click File → Open .
2	In the file type selection list, select PS2 Configuration Files .
3	Open the PowerSuite 2 project file <i>.ub2</i> to recover.

NOTE: Missing information in the PowerSuite 2 project file can be completed during the recovery process if some parameters cannot be retrieved from the PowerSuite 2 project file.

More details about this function can be found in the *SoMove online help*.

Status Bar and Synchronization Data Bar

Objective

- The synchronization data bar, above the working space, displays the synchronization status of the data between the TeSys U starter-controller and the PC.
- The status bar, at the bottom of the working space, displays the current status of the TeSys U starter-controller and information related to SoMove. For more information on the status bar icon for SoMove, see the *SoMove online help*.

Extended Mode Description

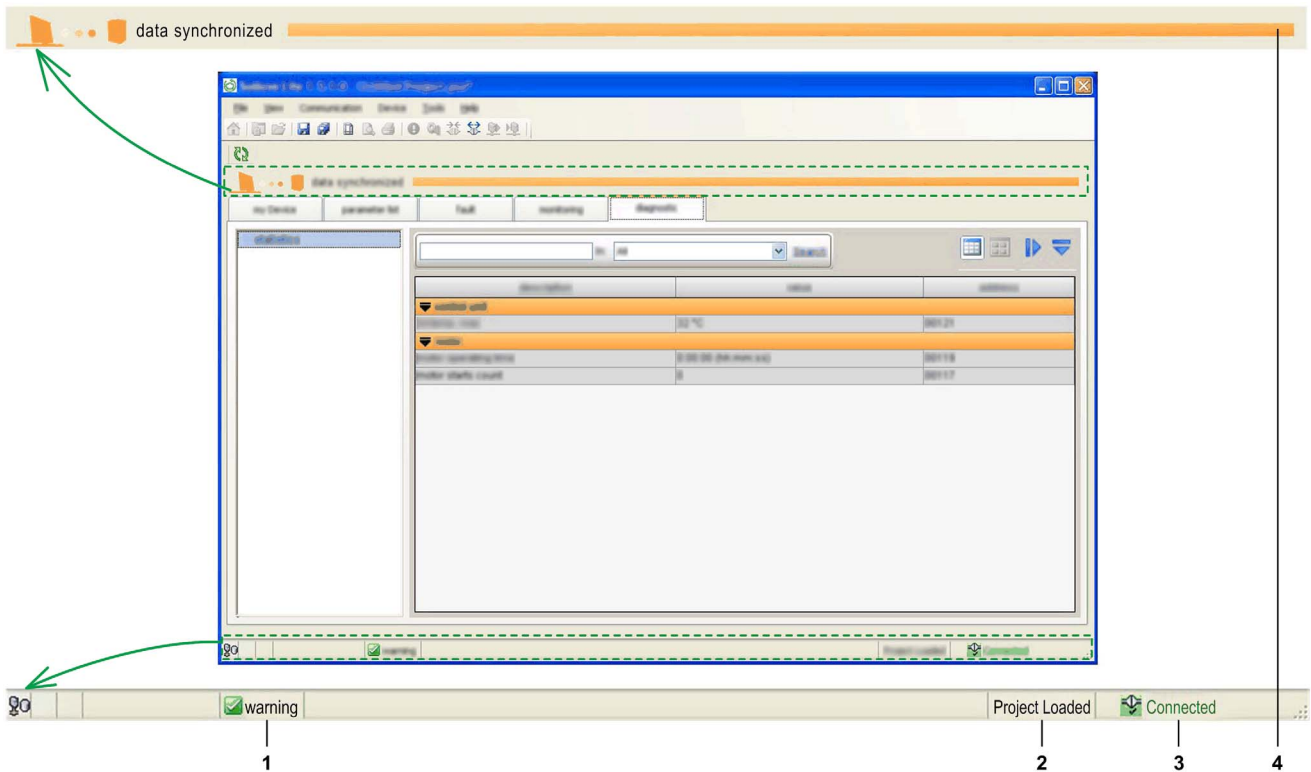

- 1 TeSys U starter-controller status
- 2 Project status
- 3 Connection status
- 4 Synchronization data bar

Basic Mode Description

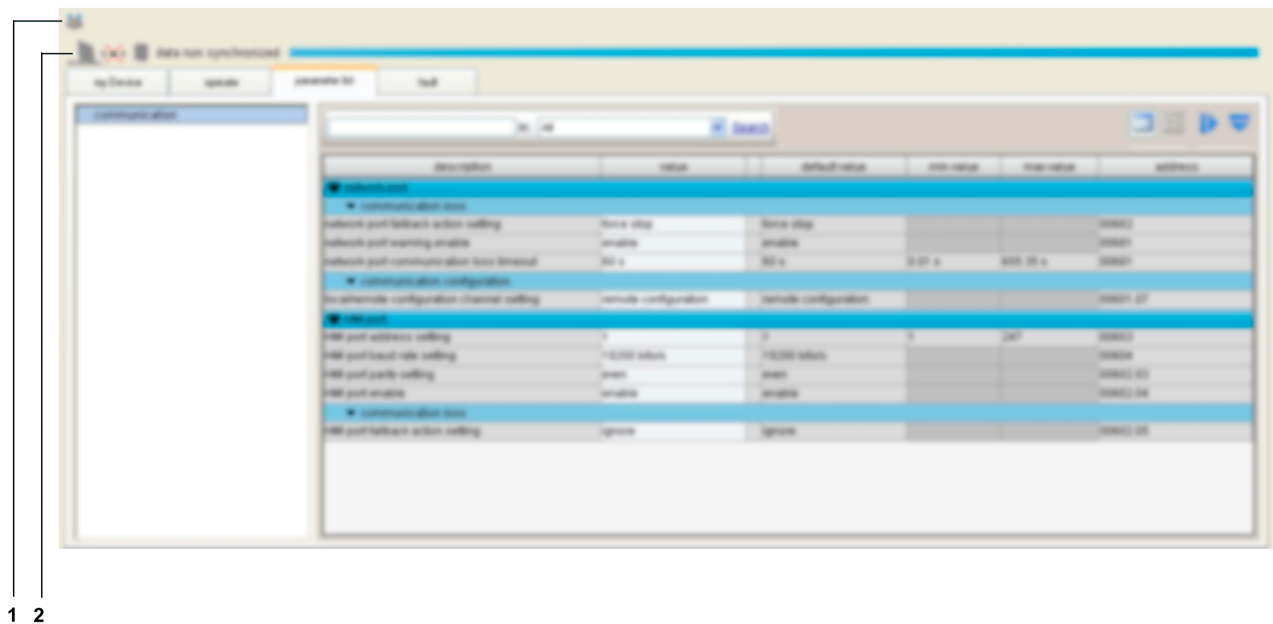

- 1 Connection status
- 2 Synchronization data bar

TeSys U Starter-Controller Status

This bar is available with the basic mode or with the extended mode using SoMove.

The TeSys U DTM displays the status of the TeSys U starter-controller. The status is available only in the connected mode.

The TeSys U starter-controller status can be one of the following:

- **in config.**: The TeSys U starter-controller is in the configuration mode.
- **trip**: The TeSys U starter-controller is in tripped state.
- **fault**: A fault is detected by the TeSys U starter-controller. Details of the detected fault are available in the **fault** tab (*see page 37*).
- **running**: The TeSys U starter-controller detects that the motor is running.
- **starting**: The motor controlled by the TeSys U starter-controller is starting up.
- **warning**: A warning is detected by the TeSys U starter-controller. Details of the detected warning are available in the **fault** tab (*see page 37*).
- **ready**: No fault is detected by the TeSys U starter-controller.
- **Not ready**: The TeSys U starter-controller is in a temporary intermediate state.

Project Status

This bar is available only with the extended mode using SoMove.

The status of the SoMove project can be:

- **Project Loaded**: A project is displayed in the working space.
- **No Project Open**: The project working space is empty.

For more information, see the section about working in the disconnected mode in the *SoMove online help*.

Connection Status

This bar is available with the basic mode or with the extended mode using SoMove.

The connection status indicates the connection mode between the TeSys U starter-controller and the PC:

	Disconnected Mode	Disturbed Mode	Connected Mode
Icon			
Description	The TeSys U starter-controller is not connected to the PC.	The connection between the TeSys U starter-controller and the PC is disturbed or lost.	The TeSys U starter-controller is connected to the PC.

Synchronization Data Area

This bar is available with the basic mode or with the extended mode using SoMove.

When the TeSys U starter-controller is in the connected mode, displayed data is automatically synchronized.

The synchronization data area indicates the synchronization status of the parameters between the TeSys U starter-controller and the PC:

	Disconnected Mode	Connected Mode
Icon		
Description	<p>The TeSys U starter-controller is not synchronized with the PC:</p> <ul style="list-style-type: none"> Parameters list headers and synchronization data area are blue. Parameters are not read in real time from the TeSys U starter-controller. All settings can be modified as in configuration mode. Modified parameters are written locally in the SoMove project on PC. The project should be saved to store these modifications. 	<p>The TeSys U starter-controller is synchronized with the PC:</p> <ul style="list-style-type: none"> Parameters list headers and synchronization data area are orange. Parameters displayed are read in real time from the TeSys U starter-controller. Some main settings can be modified only in configuration mode. Modified parameters are written in real time to the TeSys U starter-controller without requiring confirmation.

my Device Tab

Overview

This tab is available with the basic mode or with the extended mode using SoMove.

The **my Device** tab displays the main characteristics and modules of the selected TeSys U starter-controller.

Description

This figure presents the informations about the TeSys U starter-controller.

part	reference	firmware version
base	L10E32	
control unit	L10CM32BL	V3.2
communication module	L10L32B1	V2.2

Information Displayed

The **my Device** tab displays the following information about the TeSys U starter-controller:

- characteristics:
 - the TeSys U starter-controller base type
 - the TeSys U starter-controller control unit type
 - the current rating in Amperes
 - the motor phases number
 - the motor class
 - the network port protocol
- structure of the TeSys U starter-controller:
 - reference number of each module
 - firmware version of each module
- software:
 - version of the TeSys U DTM
- visual elements:
 - A picture represents the TeSys U starter-controller corresponding to the selected type.

operate Tab

Overview

This tab is available with the basic mode or with the extended mode using SoMove.
 The **operate** tab is used to set and display the TeSys U starter-controller operating data.

Description

- The working space is divided in 3 zones:
- Monitoring: to list of parameters to observe in operate tab
 - Input / Output Terminals: to simulate the activity on an Input / Output
 - Settings: to change parameters online



- 1 Monitoring area
- 2 Input / Output Terminals area
- 3 Settings area

Monitoring Parameters

Add a parameter in the Monitoring area:

Step	Action
1	Click the  button.
2	Select the parameter to add in Monitoring.
3	Click the ADD button. The parameter is displayed in the Monitoring area.

To remove a parameter from the Monitoring area, click the button  in front of the parameter to remove.

Input / Output Terminals Status

The table below shows the status of the input/output of the TeSys U starter-controller.

Status Input/Output	Color Status Box	Descriptive Text
Active	Green	Active
Inactive	Grey	Inactive

Settings Parameters

Add a parameter in the Settings area:

Step	Action
1	Click the  button.
2	Select the parameter to add in the Settings area.
3	Click the ADD button. The parameter is displayed in the Settings area.

To remove a parameter from the Settings area, click the button  in front of the parameter to remove.

Tab Zone

Overview

The following tabs display information in the same way.

Tab Name	Description	Basic Mode	Extended Mode
parameter list	Tabs display the TeSys U starter-controller parameters and status	X	XX
fault		XX	XX
monitoring		-	XX
diagnostic		-	XX

This topic presents the different parts of the screen and their function.

- Not available
X Available with restrictions
XX Available without restrictions

Description

This figure presents the common information in these tabs:

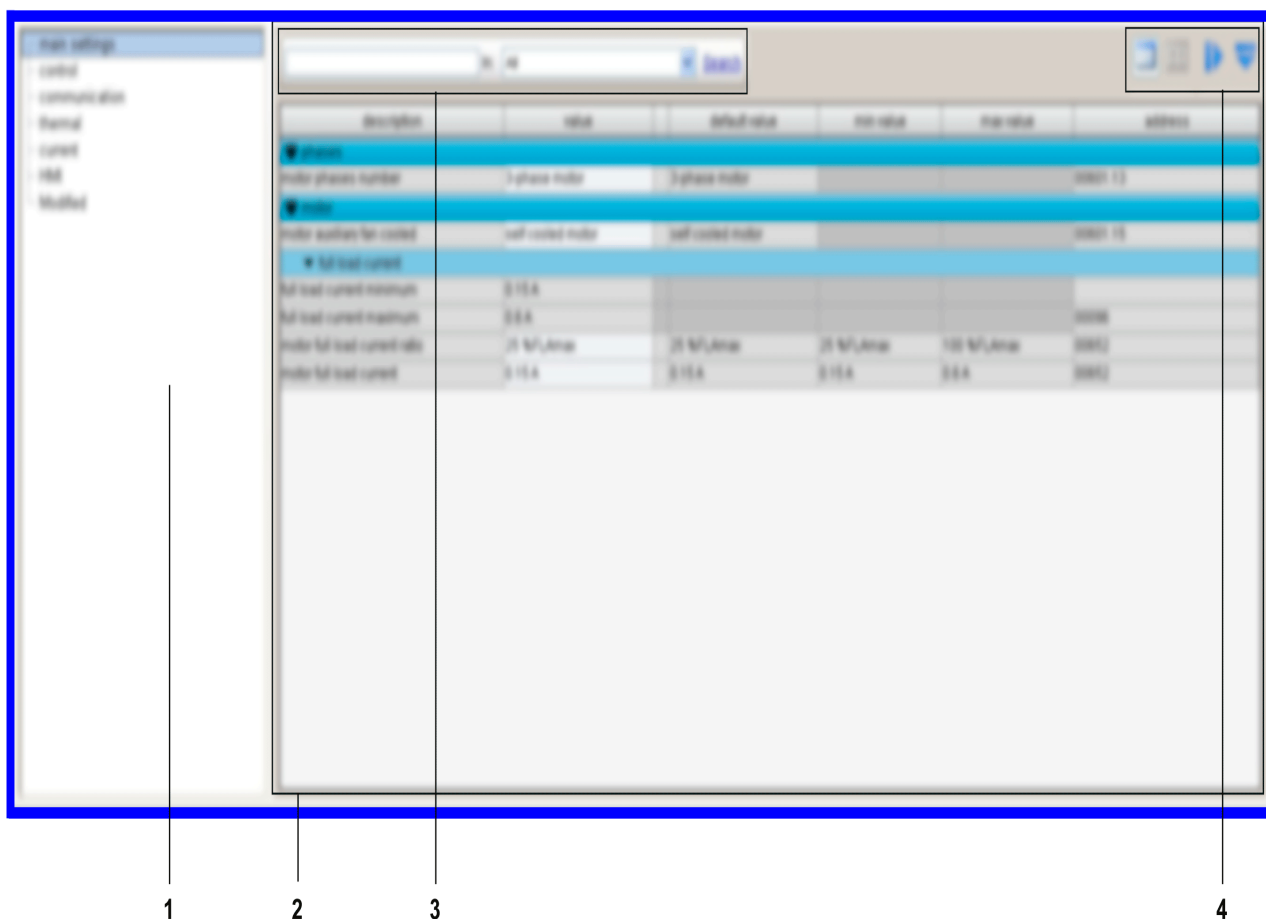





- 1 Tree view with items and subitems used to access to different tables of parameters.
- 2 Display area with the table of parameters corresponding to the selected item or subitem in the tree view.
- 3 Search function.
- 4 Display area tool bar.

Tree View

The tree view is composed of items with or without subitems. Select an item or subitem in the tree to update the display area on the right. The displayed table includes the corresponding parameters grouped in families and subfamilies.

Display Area Tool Bar

The view of the display area can be modified using the following buttons available on the top right corner of the display area:

Button	Function	Description
	Grid view	Parameters are listed by family and subfamily in a table.
	Sketch view	Parameters are presented with diagrams (charts, drawings, etc.) to explain parameters settings in a user-friendly way. Currently, TeSys U DTM does not provide such a view.
	Expand All	Expand all families and subfamilies to display all parameters.
	Collapse All	Collapse all families and subfamilies in the display area.

Display Area in Grid View

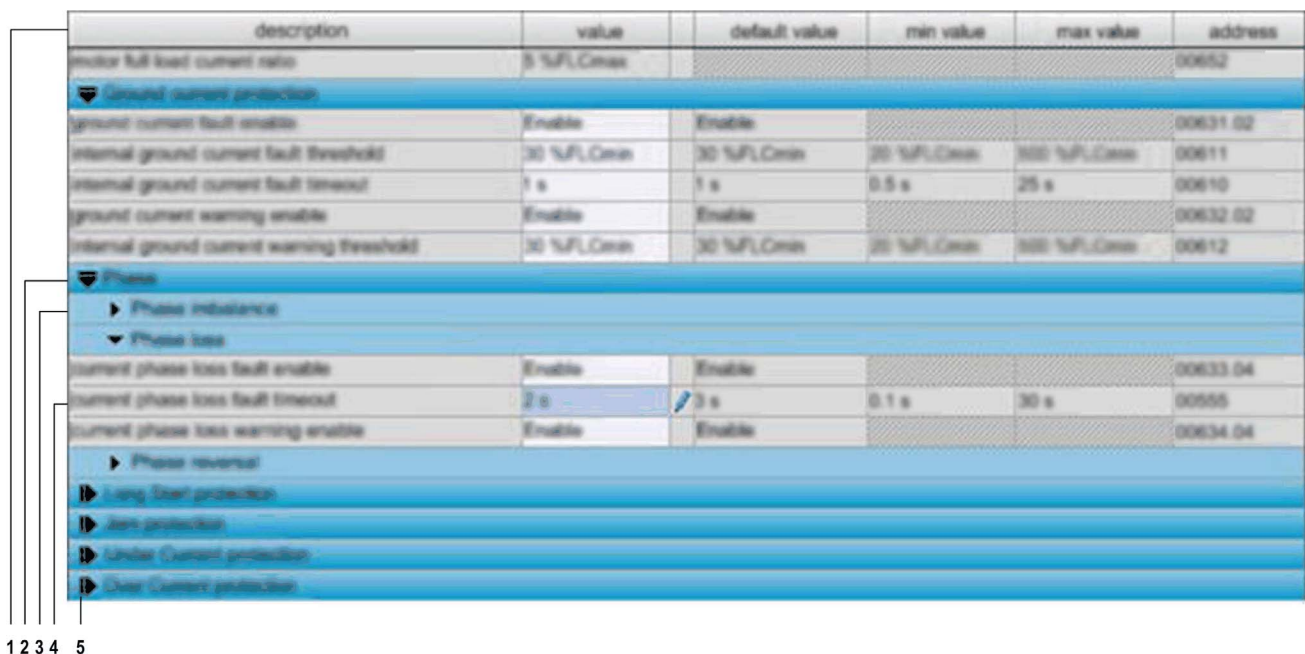

description	value	default value	min value	max value	address
motor full load current ratio	5 %FL.Cmax				00652
Ground current protection					
ground current fault enable	Enable	Enable			00631.02
internal ground current fault threshold	30 %FL.Cmax	30 %FL.Cmax	20 %FL.Cmax	500 %FL.Cmax	00611
internal ground current fault timeout	1 s	1 s	0.5 s	25 s	00610
ground current warning enable	Enable	Enable			00632.02
internal ground current warning threshold	30 %FL.Cmax	30 %FL.Cmax	20 %FL.Cmax	500 %FL.Cmax	00612
Phase					
▶ Phase imbalance					
▼ Phase loss					
current phase loss fault enable	Enable	Enable			00633.04
current phase loss fault timeout	7 s	7 s	0.1 s	30 s	00555
current phase loss warning enable	Enable	Enable			00634.04
▶ Phase reversal					
▶ Long Over protection					
▶ Icn protection					
▶ Under Current protection					
▶ Over Current protection					

1 2 3 4 5

1 Column header.

2 Parameter family.

3 Parameter subfamily.



4 Parameters:

- There is one line per parameter.
- Content of white cells can be modified, gray cells are read-only.

5 Collapse/Expand icon: to collapse or expand a parameter family or subfamily, click the arrow of the corresponding colored line.

Sorting Parameters

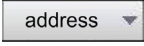
To sort the parameters according to the values in a column:

Step	Action	Result	Header Example
1	Click a first time on the header.	<ul style="list-style-type: none"> Parameters are sorted in ascending order of the values column (alphabetically or numerically) in their respective subfamily and family. Header appears with an arrow pointing upwards. 	
2	Click a second time on the header.	<ul style="list-style-type: none"> Parameters are sorted in descending order of the values in the column (alphabetically or numerically) in their respective subfamily and family. Header appears with an arrow pointing downwards. 	
3	Click a third time on the header.	<ul style="list-style-type: none"> Parameters are displayed in their initial order. Header appears according to its initial representation. 	

Modifying the Order of Columns

To modify the order of columns in the display:

Step	Action
1	Click the header of the column.
2	Drag the column to the correct location.

Search Function

To find a specific text in a displayed table:

Step	Action
1	In the first field of the search bar at the top of the display area, enter the characters to search for (part of word, code, unit, etc.).
2	Select the column to search from the list. If you select the All option, the search is performed in all columns of the table.
3	Click Search : <ul style="list-style-type: none"> The first matching text found is highlighted. To search for other instances, click again the Search button. If no matching text is found, the color of characters in the search field becomes red.

parameter list Tab

Overview

This tab is available with the basic mode but with restrictions or with the extended mode using SoMove. The **parameter list** tab is used to set and display the TeSys U starter-controller setting parameters. Only parameter values in the white entry fields can be modified.

Description

For a global description of the tab, refer to the tab zone description ([see page 32](#)).

description	value	default value	min value	max value	address
motor full load current ratio	5 %FL.Cmax				00652
Ground current protection					
ground current fault enable	Enable	Enable			00631.02
internal ground current fault threshold	30 %FL.Cmax	30 %FL.Cmax	20 %FL.Cmax	500 %FL.Cmax	00611
internal ground current fault timeout	1 s	1 s	0.5 s	25 s	00610
ground current warning enable	Enable	Enable			00632.02
internal ground current warning threshold	30 %FL.Cmax	30 %FL.Cmax	20 %FL.Cmax	500 %FL.Cmax	00612
Phase					
▶ Phase imbalance					
▼ Phase loss					
current phase loss fault enable	Enable	Enable			00633.04
current phase loss fault timeout	2 s	3 s	0.1 s	30 s	00555
current phase loss warning enable	Enable	Enable			00634.04
▶ Phase reversal					
▶ Long Start protection					
▶ Icm protection					
▶ Under Current protection					
▶ Over Current protection					

- 1 Parameter value column.
- 2 Modification column: a pen appears if the corresponding value is different from its default value.
- 3 Modifiable parameter default value column.
- 4 Numerical parameter minimum value column.
- 5 Numerical parameter maximum value column.
- 6 Address column: displays the parameter register and bit number when relevant.

Setting Numerical Values

There are 2 ways to set a parameter with a numerical value:

- direct entry of the numerical value
- value selection using the spin buttons

To set a numerical value by direct entry:

Step	Action
1	Select an item from the tree view.
2	Type the parameter value in the white entry field.
3	Press ENTER to validate the new parameter value entry: <ul style="list-style-type: none"> • If the value is between the minimum and maximum values and consistent with the resolution interval, the parameter value is set to the new value. • If the value is between the minimum and maximum values but not consistent with the resolution interval, the parameter value is rounded up to an authorized value. • If the value is not between the minimum and maximum values: <ul style="list-style-type: none"> ○ If the value requested is below the minimum value, the parameter value is set to the minimum value. ○ If the value requested is above the maximum value, the parameter value is set to the maximum value.

To set a numerical value with the spin buttons:

Step	Action
1	Select an item from the tree view.
2	Click in the white entry field of the parameter to set it with the spin buttons that are displayed on the right of the entry field.
3	Increase or decrease the value with the spin buttons. You cannot increase the value above the maximum authorized value, or decrease it below the minimum authorized value.

Editing a String

To set a string parameter:

Step	Action
1	Select an item from the tree view.
2	Type the string in the white entry field.
3	Press ENTER to validate.

Selecting Values in a List

To select a value in a list:

Step	Action
1	Select an item from the tree view.
2	Click in the white entry field of the parameter to set it with the down arrow button that is displayed on the right of the entry field.
3	Click the arrow button to open the drop-down selection list.
4	Select a value.
5	Press ENTER to validate the selection.

fault Tab

Overview

This tab is available with the basic mode or with the extended mode using SoMove.

The **fault** tab displays the detected faults or warnings related to the connected TeSys U starter-controller (*see page 51*).

The data in this tab is only significant in the connected mode.

Description

For a global description of the tab, refer to the tab zone description (*see page 32*).





This tab displays:

- the status of detected faults and warnings in the TeSys U starter-controller:
 - the fault and warning statuses
 - the fault and warning counters (*see page 59*)
- a history of the detected faults (*see page 60*)

Status Item in Tree View

The table in the display area shows the faults and warnings that can be detected by the TeSys U starter-controller. In the connected mode, it displays in real time the status of the faults and warnings detected by the connected TeSys U starter-controller.

The different columns provide the following information:

Column	Information
description	Name of the detected fault or warning.
fault	Detected fault status: <ul style="list-style-type: none"> ●  : A red light indicates that the cause of the detected fault is not resolved. ●  : A grayed out light indicates that there is no detected fault. ● When a fault detection is disabled, no light is displayed in the corresponding cell.
fault count	Amount of detected faults since the last clear all or clear statistics action.
warning	Detected warning status: <ul style="list-style-type: none"> ●  : An orange light indicates that the cause of the detected warning is not resolved. ●  : A grayed out light indicates that there is no detected warning. ● When a warning detection is disabled, no light is displayed in the corresponding cell.
warning count	Amount of detected warnings since the last clear all or clear statistics action.

Fault History Item in Tree View

The TeSys U starter-controller stores the history of the 5 last detected faults. Each record contains monitoring data when the fault occurred, this helps investigation about the fault cause. Fault N-0 contains the most recent fault record, and fault N-4 contains the oldest retained fault record.

For each detected fault, the following information is displayed:

- the detected fault code and its description
- date and time of fault detection
- value of important settings when the fault occurred
- value of measurements recorded when the fault was detected (*see page 60*)

monitoring Tab

Overview

This tab is available with the extended mode using SoMove.







The **monitoring** tab is used to monitor in real time the status and measurements of the connected TeSys U starter-controller.

The data in this tab are only significant in the connected mode.

Description

For a global description of the tab, refer to the tab zone description (*see page 32*).

The following table lists the available tree view items in the **monitoring** tab and their functions:

Tree View Item	Description
device status	<p>Displays general information about the TeSys U starter-controller status. This status is represented by:</p> <ul style="list-style-type: none"> ● values ● texts ● colored lights: <ul style="list-style-type: none"> ○  : A red light indicates a major problem in the system. ○  : An orange light indicates a minor problem in the system. ○  : A green light indicates a normal operation. ○  : A gray light indicates an inactive status.
I/O	<p>Displays the input/output status of the TeSys U starter-controller. The status of each input and output is represented by a colored light:</p> <ul style="list-style-type: none"> ●  : A green light indicates that the logic inputs/outputs are on. ●  : A gray light indicates that the logic inputs/outputs are off.
metering	<p>Displays the TeSys U starter-controller metering values grouped by type (thermal, current, voltage, or power).</p>
custom monitoring	<p>Allows the user to select measures from tree list, and displays them in a widget representation. In the connected mode, the values are automatically refreshed in real time.</p>

Custom Monitoring

You can select a number of parameters in the tree view to display the corresponding value with widgets in the display area.

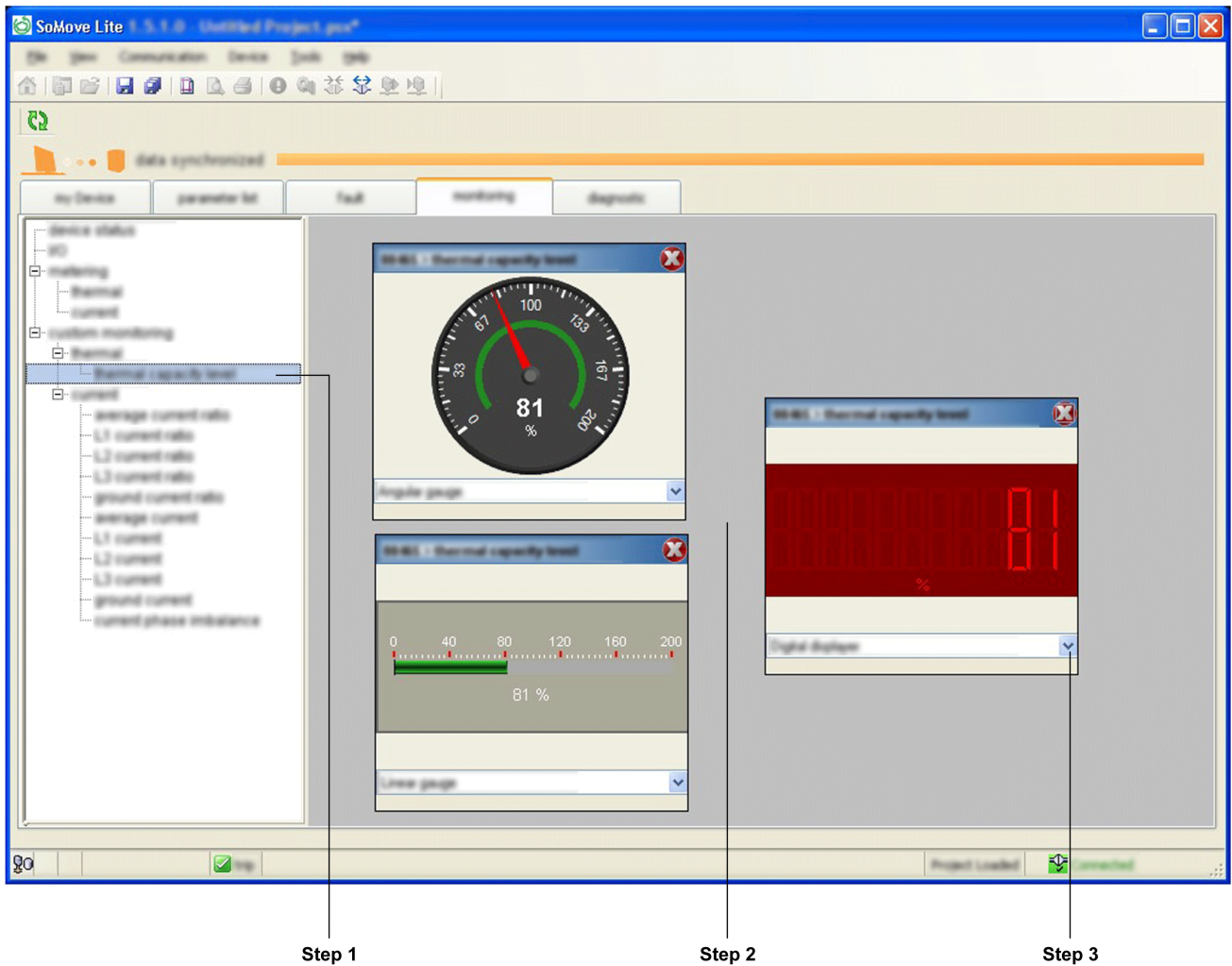

To select a parameter displayed by widgets in the **custom monitoring** display area proceed as follows:

Step	Action
1	Select the parameter to display in the tree view on the left. Multiple parameters can be selected and organized simultaneously in the display area.
2	Click the display area on the right, the value of the selected parameter is displayed with default widget type at the click location. The values are automatically refreshed in real time.
3	Modify the widget type in the selection list.

Types of Widgets

Depending on the selected parameter, 3 types of widgets can be displayed:

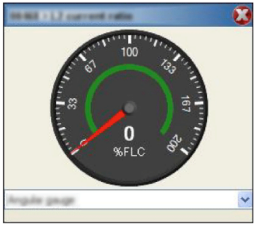
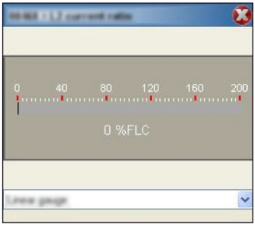
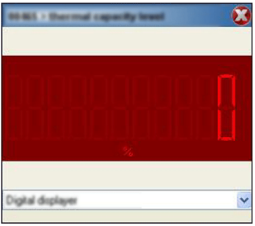
Type	Angular Gauge	Linear Gauge	Digital Display
Widget			

diagnostic Tab

Overview

This tab is available with the extended mode using SoMove.

The **diagnostic** tab displays statistics of the connected TeSys U starter-controller and companion devices.

The data in this tab is only significant in the connected mode.

Description

For a global description of this tab, refer to the tab zone description (*see page 32*).

The **statistics** tree view item is available in the **diagnostic** tab and displays:

- the LUCM control unit internal temperature (*see page 53*)
- the motor statistics (*see page 61*)

Chapter 2

Metering and Monitoring Functions

Overview

The TeSys U starter-controller provides measurement, metering, and monitoring in support of the current protection functions.

What Is in This Chapter?

This chapter contains the following sections:

Section	Topic	Page
2.1	Measurement	44
2.2	Device Monitoring Faults	51
2.3	Statistics	58

Section 2.1 Measurement

Overview

The TeSys U starter-controller uses measurements to perform protection, control, monitoring, and logic functions. Each measurement is detailed in this section.

The measurements can be accessed via:

- a PC running SoMove with the TeSys U DTM
- the LUCM Human Machine Interface (HMI)
- a PLC via the network port

What Is in This Section?

This section contains the following topics:

Topic	Page
Line Currents	45
Ground Current	46
Average Current	47
Current Phase Imbalance	48
Thermal Capacity Level	49
Minimum Wait Time	50

Line Currents

Description

The TeSys U starter-controller measures line currents from internal sensors:

- 3-phase currents L1, L2, and L3, or
- single-phase current measured from L1 and L3.

The TeSys U selection guide (*see page 16*) provides information on the functions available depending on the control unit used.

Check your system configuration to ensure that the function is enabled in your application.

Line Current Ratio Characteristics

Characteristic	Value
Unit	% of FLA (<i>see page 65</i>)
Accuracy	+/- 5 %
Resolution	1 % of FLA

Line Current Formula

The line currents in Amps are calculated by the LUCM control unit and the TeSys U DTM for display according to the following formula:

Line current = (Line current ratio) x (FLA_{max}) x (Motor full load current ratio)

Line Current Characteristics

Characteristic	Value
Unit	A
Accuracy	+/- 5 %
Resolution	0.1 A

Ground Current

Description

The TeSys U starter-controller calculates the ground current from the 3 line currents measured.

The TeSys U selection guide (*see page 16*) provides information on the functions available depending on the control unit used.

Check your system configuration to ensure that the function is enabled in your application.

Ground Current Ratio Characteristics

Characteristic	Value
Unit	% of FLAmin (<i>see page 65</i>)
Accuracy	+/- 5 %
Resolution	1 % of FLAmin

Ground Current Formula

The ground current in Amps is calculated by the LUCM control unit and the TeSys U DTM for display according to the following formula:

$$\text{Ground current} = (\text{Ground current ratio}) \times (\text{FLAmax}) / 4$$

Ground Current Characteristics

Characteristic	Value
Unit	A
Accuracy	+/- 5 %
Resolution	0.1 A

Average Current

Description

The TeSys U starter-controller calculates the average current from the line current ratio.

The TeSys U selection guide (*see page 16*) provides information on the functions available depending on the control unit used.

Check your system configuration to ensure that the function is enabled in your application.

Average Current Ratio Characteristics

Characteristic	Value
Unit	% of FLA (<i>see page 65</i>)
Accuracy	+/- 5 %
Resolution	1 % of FLA

Average Current Formula

The average current in Amps is calculated by the LUCM control unit and the TeSys U DTM for display according to the following formula:

Average current = (Average current ratio) x (FLAmax) x (Motor full load current ratio)

Average Current Characteristics

Characteristic	Value
Unit	A
Accuracy	+/- 5 %
Resolution	0.1 A

Current Phase Imbalance

Description

The TeSys U starter-controller calculates the current phase imbalance in a 3-phase system as the maximum percentage of deviation between the average current and the individual phase currents.

The TeSys U selection guide (*see page 16*) provides information on the functions available depending on the control unit used.

Check your system configuration to ensure that the function is enabled in your application.

Characteristics

Characteristic	Value
Unit	%
Accuracy	+/- 5 %
Resolution	1 %

Thermal Capacity Level

Description

The TeSys U starter-controller uses a thermal model to calculate the amount of thermal capacity used as a percentage of the rated capacity level.

The TeSys U selection guide (*see page 16*) provides information on the functions available depending on the control unit used.

Check your system configuration to ensure that the function is enabled in your application.

Characteristics

Characteristic	Value
Unit	%
Accuracy	+/- 5 %
Resolution	1 %

Minimum Wait Time

Description

The TeSys U starter-controller tracks the time remaining to restart the motor after a thermal overload fault. The automatic or remote reset of the thermal overload fault is triggered only after the minimum wait time is complete.

The TeSys U selection guide (*see page 16*) provides information on the functions available depending on the control unit used.

Check your system configuration to ensure that the function is enabled in your application.

NOTE: The minimum wait time is tracked down even when TeSys U is powered off.

Characteristics

The Minimum Wait Time function has the following characteristics:

Characteristic	Value
Unit	s
Resolution	1 s

Section 2.2

Device Monitoring Faults

Overview

The TeSys U starter-controller detects faults that affect the ability of the TeSys U to work properly (internal controller check and check of communications, wiring, and configuration errors).

The system and device monitoring fault records can be accessed via:

- a PC running SoMove with the TeSys U DTM
- the LUCM Human Machine Interface (HMI)
- a PLC via the network port

What Is in This Section?

This section contains the following topics:

Topic	Page
TeSys U Internal Faults	52
LUCM Internal Temperature	53
Wiring Faults	54
Communication Loss	55
Shunt Fault Command	57

TeSys U Internal Faults

Description

The TeSys U starter-controller detects and records faults that are internal to the device itself. Fault detection occurs either during power-up or during run time.

Internal faults can be either major or minor. Both faults can change the state of output relays.

When an internal fault occurs, the Internal Fault parameter is set, a counter is incremented, and a fault code is displayed on the LUCM HMI.

Major Internal Faults

During a major fault, the TeSys U starter-controller is unable to reliably execute its own programming.

During a major fault, communication with the TeSys U starter-controller is not possible. A power cycle is necessary to reset the TeSys U after a major fault.

TeSys U must be replaced if the fault is persistent.

The table below lists the major faults detected according to the control unit, and when fault detection occurs:

Major Internal Faults	LUCA/ LUCL + LULC**	LUCB/ LUCC/ LUCD + LULC**	LUCM	Power-Up	Run Time
Stack overflow fault	–	–	√	–	√
RAM fault	–	–	√	√	–
ROM (flash) fault	–	–	√	√	–
Hardware watchdog	–	–	√	–	√

Minor Internal Faults

Minor internal faults indicate that the data being provided to the TeSys U starter-controller is unreliable and protection may be compromised.

During a minor fault condition, the TeSys U starter-controller continues to:

- attempt to monitor status and communications, but does not accept any start commands,
- detect and report major faults, but not additional minor faults.

A manual reset is necessary to reset the TeSys U after a minor fault.

The table below lists the minor faults detected according to the control unit, and when fault detection occurs:

Minor Internal Faults	LUCA/ LUCL + LULC**	LUCB/ LUCC/ LUCD + LULC**	LUCM	Power-Up	Run Time
LUCM internal temperature	–	–	√	√	√
ASIC1 read-after-write fault	–	–	√	√	√
ASIC1 initialize check fault	–	–	√	√	–
ASIC2 watchdog	–	√	√	–	√
ASIC2 DTH over temperature	–	√	√	√	√
Current detected while OFF	–	–	√	–	√
FRAM strings checksum fault	–	–	√	–	√
EEPROM checksum fault	–	–	√	√	√
Current sensor loss fault	–	–	√	–	√

LUCM Internal Temperature

Description

The LUCM control unit monitors its internal temperature, and reports warning and minor fault conditions. Fault detection cannot be disabled.

The LUCM control unit retains a record of the highest reached internal temperature.

Characteristics

Characteristic	Value
Unit	°C
Accuracy	+/- 4 °C (+/- 7.2 °F)
Resolution	1 °C

Parameters

The LUCM Internal Temperature function includes the following fixed warning and fault thresholds:

Condition	Fixed Threshold Value	Sets Parameter
Internal temperature warning	80 °C (176 °F)	LUCM Internal Temperature Warning
Internal temperature minor fault	90 °C (194 °F)	LUCM Internal Fault

A warning condition ceases when LUCM Internal Temperature falls below 80 °C (176 °F).

Action After Fault Detection

If the LUCM internal temperature is too high:

- reduce the ambient temperature, or
- increase the distance between devices.

LUCM Internal Temperature Max

The LUCM Internal Temperature Max is the highest internal temperature, expressed in °C, detected by the LUCM control unit internal temperature sensor.

The LUCM updates this value whenever it detects an internal temperature greater than the current value.

The maximum internal temperature value is not cleared when factory settings are restored using the Clear All Command, or when statistics are reset using a Clear Statistics Command.

Wiring Faults

Description

The LUCM control unit checks external wiring connections and reports a fault when it detects incorrect or conflicting external wiring. It detects 3 types of wiring errors:

- Phase Configuration Error
- A2 missing
- A1 overvoltage

Phase Configuration Error

The LUCM control unit checks all 3 motor phases and reports an error if it detects current in phase 2, if the TeSys U is configured for single-phase operation.

A2 Missing

The LUCM control unit checks that the A2 terminal on the TeSys U power base is connected to 0 Vdc.

A1 Overvoltage

The LUCM control unit checks that the voltage on A1–A2 terminals on the TeSys U power base is in the correct range.

If the voltage is greater than 34 Vdc, this fault is reported.

Communication Loss

Description

The TeSys U starter-controller monitors communication through:

- the network port on the LULC•• communication module
- the HMI port on the LUCM control unit

Network Port Communication Loss

The TeSys U starter-controller monitors network communication through the network port on the LULC•• communication module and reports a warning when network communication is lost:

- With the LULC031 or LULC033 Modbus communication module, the communication is lost for a time period equal to, or longer than, an adjustable parameter, the Network port watchdog timeout (refer to *Configuration of the LULC•• Network Port, page 98*).
- With other LULC•• communication modules, the communication loss detection is part of the protocol management, without adjustable parameters.

When the network communication is lost, the TeSys U starter-controller switches to Fallback mode.

Network Port Communication Loss Fallback Strategy

The communication loss fallback strategy parameter is used to adjust the fallback mode in case of communication loss with the PLC.

The different fallback modes are:

- Ignore communication loss
- Freeze outputs
- Force stop
- Raise a communication loss warning
- Force run forward
- Force run reverse

 WARNING
<p>AUTOMATIC RESTART OF THE MOTOR</p> <p>If communication is stopped, outputs OA1–OA3 take the status corresponding to the selected fallback mode, but the control bits Motor Run Forward Command and Motor Run Reverse Command are not modified.</p> <p>When a loss of communication warning is acknowledged through the communication network using the Reset Comm Loss command, the motor automatically restarts if the control bits were not previously overwritten to 0 by the PLC application.</p> <p>Failure to follow these instructions can result in death, serious injury, or equipment damage.</p>

The following table describes the different fallback modes:

Fallback Mode	Loss of Communication	Communication Recover	Loss of Communication Acknowledgement
Ignore communication loss	<ul style="list-style-type: none"> • No detection of the loss of communication • OA1 and OA3 keep their status 	<ul style="list-style-type: none"> • No detection of the loss of communication • OA1 and OA3 keep their status 	No acknowledgement of the loss of communication
Freeze outputs	<ul style="list-style-type: none"> • OA1 and OA3 keep their status • ERR LED blinking on the front face 	<ul style="list-style-type: none"> • OA1 and OA3 keep their status • ERR LED blinking on the front face • Each new On/Off command is stored but with no impact on OA1 and OA3 	<ul style="list-style-type: none"> • By Reset Comm Loss command • Once the acknowledgement is done, the last command is enabled • ERR LED switches off
Force stop	<ul style="list-style-type: none"> • OA1 and OA3 are forced to 0 • ERR LED blinking on the front face 	<ul style="list-style-type: none"> • OA1 and OA3 are forced to 0 • ERR LED blinking on the front face • Each new On/Off command is stored but with no impact on OA1 and OA3 	<ul style="list-style-type: none"> • By Reset Comm Loss command • Once the acknowledgement is done, the last command is enabled • ERR LED switches off

Fallback Mode	Loss of Communication	Communication Recover	Loss of Communication Acknowledgement
Raise a communication loss warning	<ul style="list-style-type: none"> ● OA1 and OA3 keep their status ● ERR LED blinking on the front face 	<ul style="list-style-type: none"> ● OA1 and OA3 keep their status ● ERR LED blinking on the front face ● Each new On/Off command is stored but with no impact on OA1 and OA3 	<ul style="list-style-type: none"> ● By Reset Comm Loss command ● ERR LED switches off
Force run forward	<ul style="list-style-type: none"> ● OA1 is forced to 0, OA3 is forced to 0 ● ERR LED blinking on the front face 	<ul style="list-style-type: none"> ● OA1 is forced to 0, OA3 is forced to 0 ● ERR LED blinking on the front face ● Each new On/Off command is stored but with no impact on OA1 and OA3 	<ul style="list-style-type: none"> ● By Reset Comm Loss command ● Once the acknowledgement is done, the last command is enabled ● ERR LED switches off
Force run reverse	<ul style="list-style-type: none"> ● OA1 is forced to 0, OA3 is forced to 0 ● ERR LED blinking on the front face 	<ul style="list-style-type: none"> ● OA1 is forced to 0, OA3 is forced to 0 ● ERR LED blinking on the front face ● Each new On/Off command is stored but with no impact on OA1 and OA3 	<ul style="list-style-type: none"> ● By Reset Comm Loss command ● Once the acknowledgement is done, the last command is enabled ● ERR LED switches off

HMI Port Communication Loss

The communication through the HMI port on the LUCM control unit is monitored. The communication is lost if the communication is inactive for more than 10 seconds (fixed threshold).

When the communication is lost, the behavior of the TeSys U starter-controller is defined by the value set for the HMI port watchdog action setting.

HMI Port Watchdog Action Setting	Description
Ignored (factory setting)	No detection of HMI port communication loss.
Warning	The detection of HMI port communication loss reports a warning. The warning disappears after the communication is restored.
Drop-out	The detection of HMI port communication loss opens the contactor coil and reports a fault. The fault can be reset by depressing the ENT key on the LUCM control unit or sending a reset command via the HMI or network communication ports.
Trip	The detection of HMI port communication loss trips the breaker and reports a fault. The fault must be reset by a manual reset on the TeSys U power base.

Shunt Fault Command

Description

The TeSys U starter-controller may receive a trip command sent by an external device via the communication network.

This external trip command is triggered by setting the parameter Shunt Fault Command.

The starter-controller must be manually reset after clearing the Shunt Fault Command.

Section 2.3

Statistics

Overview

The TeSys U starter-controller with an LUCM control unit records statistics that can be retrieved for operational analysis.

The TeSys U statistic parameters can be accessed via:

- a PC running SoMove with the TeSys U DTM
- the LUCM Human Machine Interface (HMI)
- a PLC via the network port

All statistic parameters are reset by executing the Clear Statistics Command or the Clear All Command.

What Is in This Section?

This section contains the following topics:

Topic	Page
Fault and Warning Counters	59
Fault History	60
Motor Statistics	61

Fault and Warning Counters

About Counters

A counter contains a value from 0 to 65,535 and increments by a value of 1 when the event related to this counter occurs.

Counters are saved on power loss.

Protection Fault Counters

Protection fault counters include:

- Short-Circuit Faults Count
- Magnetic Faults Count
- Ground Current Faults Count
- Thermal Overload Faults Count
- Long Start Faults Count
- Jam Faults Count
- Phase Imbalance Faults Count
- Undercurrent Faults Count
- Shunt Faults Count

Protection Warning Counters

The Thermal Overload Warnings Count is the only warning counter available.

Communication Loss Counters

Communication loss counters include:

- HMI Port Faults Count: number of times communications via the HMI port on the LUCM control unit was lost.
- Network Port Drop-out Faults Count: number of times the LULC** communication module generates a drop-out.
- Network Port Trip Faults Count: number of times the LULC** communication module generates a trip.

Internal Fault Counters

Internal fault counters include:

- Controller Internal Faults Count: number of major and minor internal faults (*see page 52*).
- Internal Port Faults Count: number of TeSys U internal communication faults, plus the number of failed attempts to identify the network communication module.
- Network Port Internal Faults Count: number of internal faults experienced by the LULC** communication module.

Fault History

Fault History

The TeSys U starter-controller records the last 5 detected faults.

Fault n-0 contains the most recent fault record, and Fault n-4 contains the oldest retained fault record.

Each fault record includes:

- Fault code
- Value of Setting Motor Full Load Amps Ratio (% of FLAmax)
- Value of measurements:
 - Thermal Capacity Level
 - Average Current Ratio
 - L1, L2, L3 Current Ratio
 - Ground Current Ratio

Motor Statistics

Motor Starts Counters

The TeSys U starter-controller counts the number of motor starts and records the data as a statistic that can be retrieved for operational analysis.

Operating Time

The TeSys U starter-controller tracks motor operating time and records the value in the Operating Time parameter.

Use this information to help schedule motor maintenance, such as lubrication, inspection, and replacement.

Chapter 3

Motor Protection Functions

Overview

This chapter describes the motor protection functions provided by the TeSys U starter-controller.

What Is in This Chapter?

This chapter contains the following topics:

Topic	Page
Motor Protection Characteristics	64
FLA (Full Load Amps) Settings	65
Thermal Overload	66
Short-Circuit	69
Magnetic	70
Ground Current	71
Current Phase Imbalance	73
Long Start	76
Jam	78
Undercurrent	80

Motor Protection Characteristics

Introduction

The TeSys U starter-controller monitors line current and ground current. The TeSys U starter-controller uses parameters in protection functions to detect fault and warning conditions.

All motor protection functions include fault detection, and most protection functions also include warning detection.

Operation

The following diagram describes the operation of a typical motor protection function:

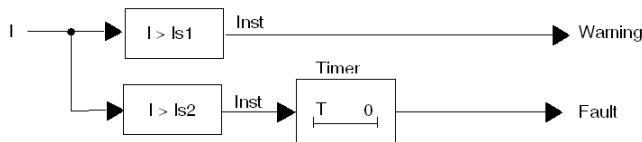

- I** Measurement of the monitored parameter
- Is1** Warning threshold setting
- Is2** Fault threshold setting
- T** Fault timeout setting
- Inst** Instantaneous warning/fault detection

Settings

Some protection functions include configurable settings, including:

- Fault threshold: A limit setting for the monitored parameter that triggers a protection function fault.
- Warning threshold: A limit setting for the monitored parameter that triggers a protection function warning.
- Fault timeout: A time delay that must expire before the protection function fault is triggered.

Some protection functions may be disabled by setting a specific value as the threshold.

Most protection settings can be modified only when the motor is stopped.

Hysteresis

To improve stability, motor protection functions apply a hysteresis value that is added to, or subtracted from, limit threshold settings before a fault or warning response is reset.

The hysteresis value is calculated as a percentage, typically 1 %, of the limit threshold and is:

- subtracted from the threshold value for upper limit thresholds,
- added to the threshold value for lower limit thresholds.

The following diagram describes the logic result of measurement processing (Inst) when hysteresis is applied to an upper limit threshold:

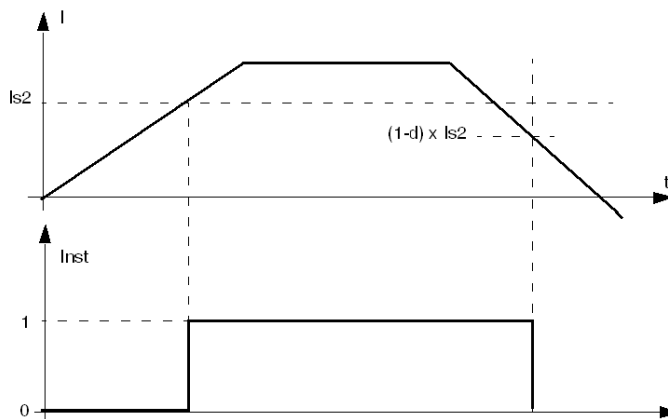

- d** Hysteresis percentage

FLA (Full Load Amps) Settings

FLA Definitions

The **Full Load Amps (FLA)** represents the actual full-load current of the motor being protected by the TeSys U starter-controller. The FLA is a motor characteristic and can be found on the motor plate.

Many protection parameters are set as a ratio of FLA.

The **FLAmax** is the maximum full-load current rating of the control unit. This value represents the highest full-load current value that can be set on a given control unit.

The **FLAmin** is the minimum full-load current rating of the control unit. This value represents the lowest full-load current value that can be set on a given control unit. It corresponds to 25 % of FLAmax.

Control Unit	FLAmin (A)	FLAmax (A)	Power Base Rating (A)
LUC•X6••	0.15	0.6	12, 32, and 38
LUC•1X••	0.35	1.4	12, 32, and 38
LUC•05••	1.25	5	12, 32, and 38
LUC•12••	3	12	12, 32, and 38
LUC•18••	4.5	18	32 and 38
LUC•32••	8	32	32 and 38
LUC•38••	9.5	38	38

FLA Setting

The FLA is set from FLAmin to FLAmax as a percentage of FLAmax, in 1 % increments.

The formula to obtain the FLA in % from the FLA in A is:

$$\text{FLA (in \%)} = 100 \times \text{FLA (in A)} / \text{FLAmax (in A)}$$

The result must be rounded to the nearest integer.

Example

Data:

- FLA (in A) = 0.43 A
- FLAmax = 1.4 A

Calculated parameter:

- $\text{FLA (in \%)} = \text{FLA (in A)} / \text{FLAmax} = 100 \times 0.43 / 1.4 = 30.714$ rounded to 31 %

Thermal Overload

Description

The TeSys U starter-controller monitors the motor’s thermal capacity level and signals:

- a warning when the thermal capacity level exceeds a configured warning threshold
- a fault when the thermal capacity level continuously exceeds a fixed fault threshold

The thermal model used to calculate the thermal capacity level takes into account:

- the line currents
- the motor trip class
- the ventilation mode of the motor, with or without auxiliary fan

⚠ CAUTION

RISK OF MOTOR OVERHEATING

- The Motor Trip Class parameter must be set to the thermal heating characteristics of the motor. Refer to the motor manufacturer’s instructions before setting this parameter.
- The Motor Aux Fan Cooled parameter must be set only if the motor is cooled by an auxiliary fan to avoid incorrect calculation of the thermal capacity level.

Failure to follow these instructions can result in injury or equipment damage.

There is no time delay for the thermal overload warning.

The TeSys U starter-controller calculates the Thermal Capacity Level in all operating states. When power to the TeSys U starter-controller is lost, the TeSys U starter-controller retains the last measurements of the motor’s thermal state until power is re-applied.

Thermal overload fault detection cannot be disabled, only the warning detection can be enabled or disabled.

- The TeSys U starter-controller clears a thermal overload warning when the thermal capacity level falls 2 % below the warning threshold.
- The TeSys U starter-controller stops reporting a thermal overload fault when the thermal capacity level falls below 98 %. To clear the fault it must be acknowledged through a reset action (*see page 93*).

Operation

The thermal overload protection function is based on a thermal model of the motor.

Using measured current and the input motor trip class setting, the TeSys U starter-controller calculates the thermal capacity level of the motor, as described below:

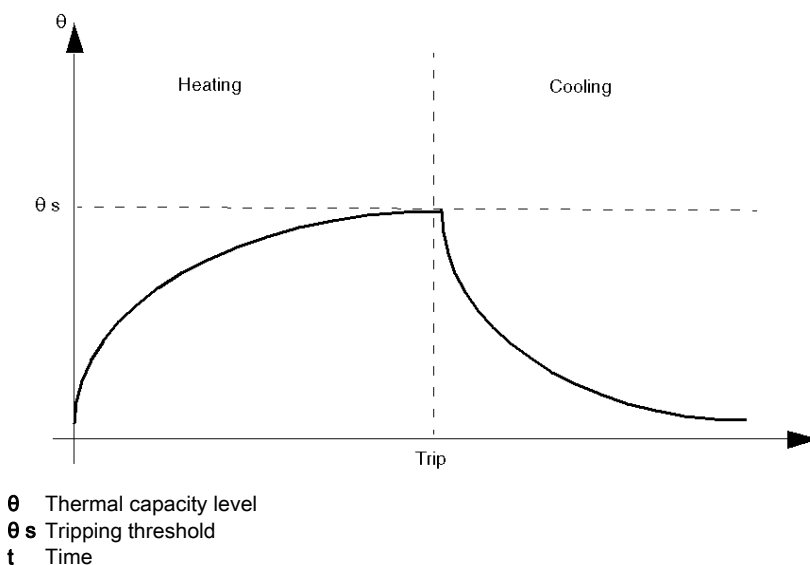

The Thermal Capacity Level parameter (which indicates thermal capacity level due to load current) is incremented during both start and run states. When the TeSys U starter-controller detects that the thermal capacity level (θ) exceeds the fault threshold (θ_s), it triggers a thermal overload fault, as described below:

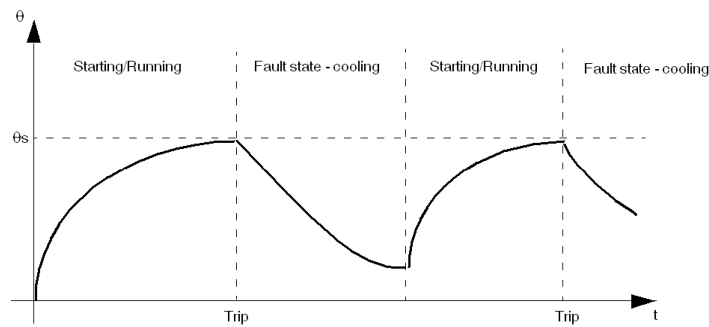

Motor Trip Class

The trip class shows timeout (in seconds) prior to a thermal overload of 600 % FLA being triggered.

- The trip class is fixed and equal to class 10 for the LUCA, LUCB, and LUCC control units
- The trip class is fixed and equal to class 20 for the LUCD control units
- The trip class is adjustable for the LUCM control units

⚠ CAUTION

INCORRECT LUCM TRIP CLASS SETTING

The Trip Class setting must correspond to the thermal capacity of the motor.

Failure to follow these instructions can result in injury or equipment damage.

Motor Aux Fan

For motors cooled by an auxiliary fan when stopped, the motor cooling period is divided by 4.

Function Characteristics

The thermal overload function includes the following features:

- 3 settings according to motor:
 - Motor Full Load Current Ratio
 - Motor Trip Class
 - Motor Aux Fan Cooled
- 2 configurable thresholds:
 - Thermal Overload Warning Threshold
 - Thermal Overload Fault Reset Threshold
- 1 measure:
 - Thermal Capacity Level
- 2 function outputs:
 - Thermal Overload Warning
 - Thermal Overload Fault
- 2 counting statistics:
 - Thermal Overload Faults Count
 - Thermal Overload Warnings Count

Block Diagram

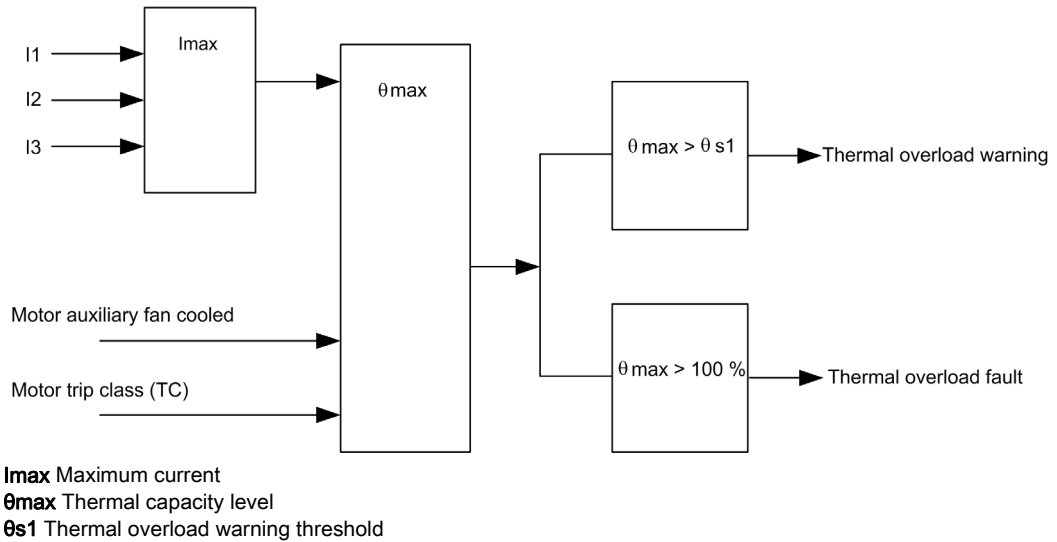

Parameter Settings

The thermal overload function has the following configurable parameter settings:

Parameter	Setting Range	Factory Setting
Motor full load current ratio	25...100 % of FLAmax	25 % of FLAmax
Motor trip class	5...30 in increments of 5	5
Motor aux fan cooled	Yes/No	No
Warning threshold	<ul style="list-style-type: none"> 0 to disable the warning detection, or 10...100 % of thermal capacity level 	85 % of thermal capacity level
Fault reset timeout	1...1,000 s in 1 s increments	120 s
Fault reset threshold	35...95 % of thermal capacity level in increments of 5 %	80 % of thermal capacity level

The thermal overload function has the following non-configurable parameter settings:

Parameter	Fixed Setting
Thermal overload fault threshold	100 % of thermal capacity level

Technical Characteristics

The thermal overload function has the following characteristics:

Characteristic	Value
Hysteresis	-1 % of thermal overload warning threshold
Trip time accuracy	+/- 0.1 s

Automatic Reset

In automatic fault reset mode, the thermal overload fault is automatically reset if the thermal capacity level is lower than the fault reset threshold and the fault reset timeout has elapsed.

NOTICE

INCORRECT RESET TIMEOUT SETTING

Thermal reset timeout must be sufficient to allow motor to cool after a thermal trip. See the motor manufacturer's instructions before adjusting this setting.

Failure to follow these instructions can result in equipment damage.

Short-Circuit

Description

The short-circuit function detects a fault when the phase current exceeds the fixed threshold of $14.2 \times FLA_{max}$.

The purpose of the short-circuit function is to provide a fast trip (faster than the magnetic overload function) when very high currents are detected.

Fault detection cannot be disabled.

This function has no warning.

Function Characteristics

The short-circuit function includes the following features:

- 1 function output:
 - Short-circuit Fault
- 1 counting statistic:
 - Short-circuit Faults Count

Block Diagram

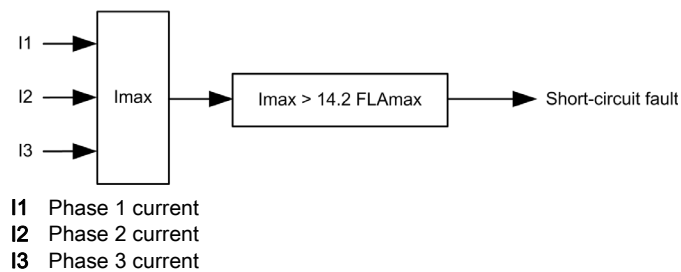

Magnetic

Description

The magnetic function detects a fault when the phase current continuously exceeds a set threshold for more than 100 ms.

The magnetic threshold must be set below $14.2 \times FLA_{max}$, which is the fixed threshold of the short-circuit function.

Fault detection cannot be disabled.

This function has no warning.

Function Characteristics

The magnetic function includes the following features:

- 1 threshold:
 - Magnetic Fault Threshold
- 1 function output:
 - Magnetic Fault
- 1 counting statistic:
 - Magnetic Faults Count

Block Diagram

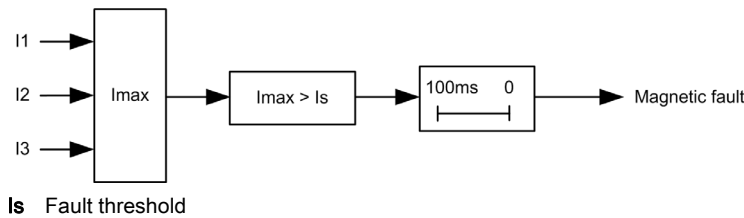

Parameter Settings

The magnetic function has the following parameters:

Parameter	Setting Range	Factory Setting
Magnetic fault threshold	300...1,700 % FLA in 20 % increments	1,420 % FLA

⚠ DANGER

INCORRECT MAGNETIC TRIP LEVEL SETTING

Device selection and configuration must comply with national and local safety codes.

Failure to follow these instructions will result in death or serious injury.

Technical Characteristics

Characteristic	Value
Hysteresis	-1 % of Fault threshold

Ground Current

Description

The ground current function sums the current readings from the secondary of the internal current transformers and signals:

- a warning when the summed current exceeds a set threshold
- a fault when the summed current continuously exceeds a set threshold for a set period of time

⚠ DANGER

IMPROPER FAULT DETECTION

The ground current function does not protect people from harm caused by ground current.

Ground fault thresholds must be set to protect the motor and related equipment.

Ground fault settings must conform to national and local safety regulations and codes.

Failure to follow these instructions will result in death or serious injury.

The ground current function has a single fault time delay.

The ground current function can be enabled when the motor is in ready state, start state, or run state.

Fault and warning monitoring can be separately enabled and disabled.

Function Characteristics

The ground current function includes the following features:

- 2 measures:
 - Ground Current in Amperes
 - Ground Current Ratio in % of FLA_{min}
- 2 thresholds:
 - Warning Threshold
 - Fault Threshold
- 1 fault time delay:
 - Fault Timeout
- 2 function outputs:
 - Ground Current Warning
 - Ground Current Fault
- 1 counting statistic:
 - Ground Current Faults Count

Block Diagram

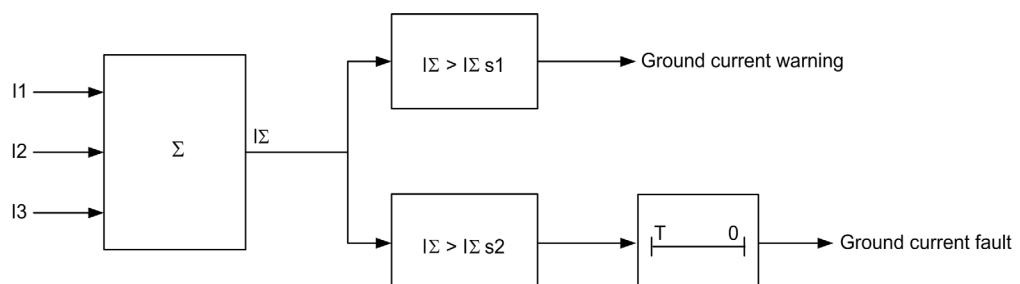

- I1** Phase 1 current
- I2** Phase 2 current
- I3** Phase 3 current
- IΣ** Summed current
- IΣs1** Warning threshold
- IΣs2** Fault threshold
- T** Fault timeout

Parameter Settings

The ground current function has the following parameters:

Parameter	Setting Range	Factory Setting
Ground current fault threshold	<ul style="list-style-type: none"> 0 to disable the fault detection, or 20...500 % of FLAmin in 1 % increments 	30 % of FLAmin
Ground current fault timeout	0.1...1.2 s in 0.1 s increments	1 s
Ground current warning threshold	<ul style="list-style-type: none"> 0 to disable the warning detection, or 20...500 % of FLAmin in 1 % increments 	30 % of FLAmin

Technical Characteristics

The ground current function has the following characteristics:

Characteristic	Value
Hysteresis	-1 % of Fault threshold or Warning threshold
Trip time accuracy	+/- 0.1 s or +/-5 %

Example

The following diagram describes a ground current fault occurring during run state:

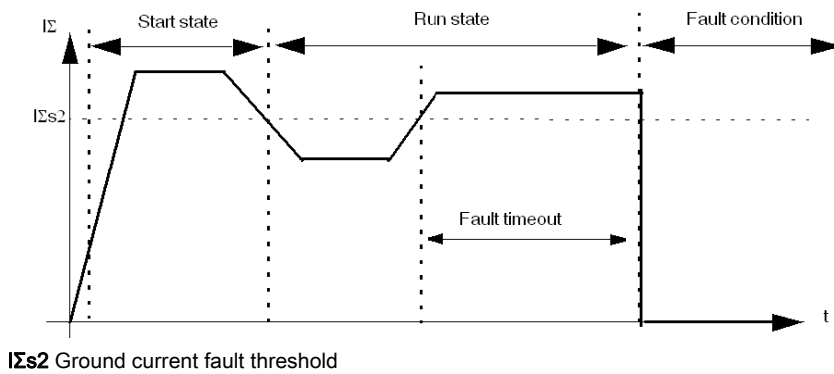

Current Phase Imbalance

Description

The current phase imbalance function signals:

- a warning when the current in any phase differs by more than a set percentage from the average current in all 3 phases
- a fault when the current in any phase differs by more than a set percentage from the average current in all 3 phases for a set period of time

The function is enabled only if the average current in all 3 phases is greater than 25 % of FLA.

CAUTION

RISK OF MOTOR OVERHEATING

The Current Phase Imbalance Fault Threshold must be properly set to protect the wiring and motor equipment from harm caused by motor overheating.

- The value you input must conform to national and local safety regulations and codes.
- Refer to the motor manufacturer's instructions before setting this parameter.

Failure to follow these instructions can result in injury or equipment damage.

This function has 2 adjustable fault time delays:

- one applies to current imbalances occurring while the motor is starting up
- one applies to current imbalances occurring after startup while the motor is running

Fault and warning monitoring can be separately enabled and disabled.

The function applies only to 3-phase motors.

Function Characteristics

The current phase imbalance function includes the following features:

- 2 thresholds:
 - Warning Threshold
 - Fault Threshold
- 2 fault time delays:
 - Fault Timeout Starting
 - Fault Timeout Running
- 1 measure:
 - Current Phase Imbalance
- 2 function outputs:
 - Current Phase Imbalance Warning
 - Current Phase Imbalance Fault
- 1 counting statistic:
 - Current Phase Imbalance Faults Count

Block Diagram

Current phase imbalance warning and fault:

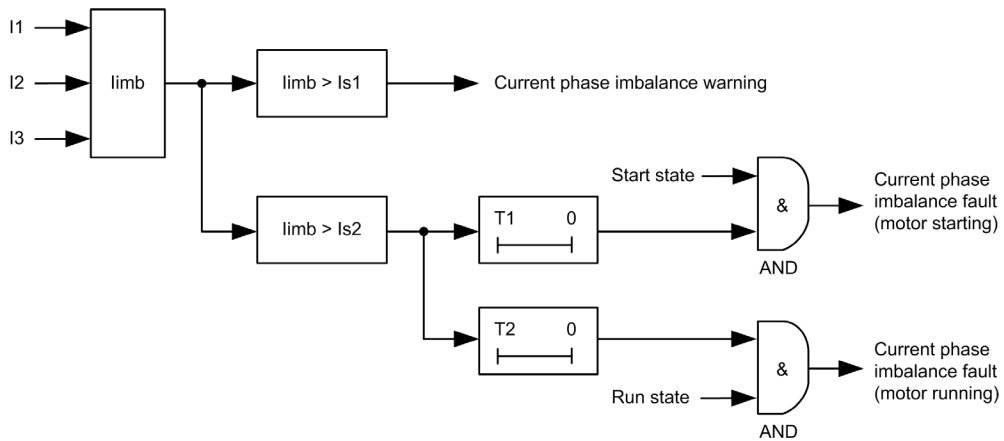

- I1** Phase 1 current
- I2** Phase 2 current
- I3** Phase 3 current
- limb** Current imbalance ratio for 3-phase
- Is1** Warning threshold
- Is2** Fault threshold
- T1** Fault timeout starting
- T2** Fault timeout running

Parameter Settings

The current phase imbalance function has the following parameters:

Parameter	Setting Range	Factory Setting
Fault threshold	<ul style="list-style-type: none"> ● 0 to disable the fault detection, or ● 10...30 % of the calculated imbalance in 1 % increments 	10 %
Fault timeout starting	0.2...20 s in 0.1 s increments	0.7 s
Fault timeout running	0.2...20 s in 0.1 s increments	5 s
Warning threshold	<ul style="list-style-type: none"> ● 0 to disable the warning detection, or ● 10...30 % of the calculated imbalance in 1 % increments 	10 %

Technical Characteristics

The current phase imbalance function has the following characteristics:

Characteristic	Value
Hysteresis	-1 % of fault or warning threshold
Trip time accuracy	+/-0.3 s or +/-5 %

Example

The following diagram describes the detection of a current phase imbalance occurring during run state:

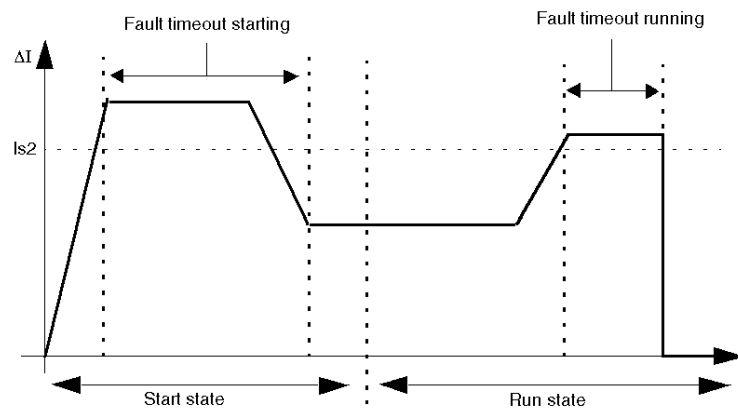

ΔI Percentage difference between current in any phase and the 3 phase current average

$Is2$ Fault threshold

Long Start

Description

The long start function detects a locked or stalled rotor in start state and signals:

- a warning when current exceeds a separately set threshold
- a fault when current continuously exceeds a separately set threshold for a set period of time

Each predefined operating mode has its own current profile, representing a successful start cycle for the motor. The TeSys U starter-controller detects a long start fault condition whenever the actual current profile, occurring after a start command, varies from the expected profile.

The long start function signals a warning when a fault related to this problem occurs.

Fault and warning monitoring can be separately enabled and disabled.

Start Cycle

The configurable parameters for the Long Start protection function, Long Start Fault Threshold, and Long Start Fault Timeout are used by the TeSys U starter-controller when defining and detecting the motor's start cycle (see page 86).

Function Characteristics

The long start function includes the following features:

- 2 thresholds:
 - Warning Threshold
 - Fault Threshold
- 1 fault time delay:
 - Fault Timeout
- 2 function outputs:
 - Long Start Warning
 - Long Start Fault
- 1 counting statistic:
 - Long Start Faults Count

Block Diagram

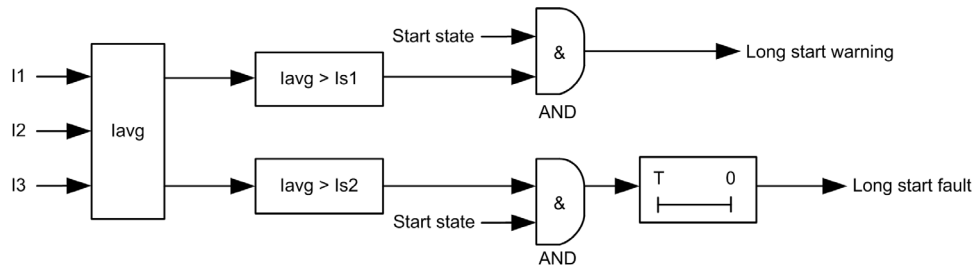

- I1** Phase 1 current
- I2** Phase 2 current
- I3** Phase 3 current
- Is1** Warning threshold
- Is2** Fault threshold
- T** Fault timeout

Parameter Settings

The long start function has the following parameters:

Parameter	Setting Range	Factory Setting
Fault threshold	<ul style="list-style-type: none"> ● 0 to disable the fault detection, or ● 100...800 % of FLA in 10 % increments 	100 % of FLA
Fault timeout	1...200 s in 1 s increments	10 s
Warning threshold	<ul style="list-style-type: none"> ● 0 to disable the warning detection, or ● 100...800 % of FLA in 10 % increments 	0

Technical Characteristics

The long start function has the following characteristics:

Characteristic	Value
Hysteresis	-1 % of Fault threshold
Trip time accuracy	+/- 0.1 s or +/- 5 %

Example

The following diagram describes the occurrence of a long start fault:

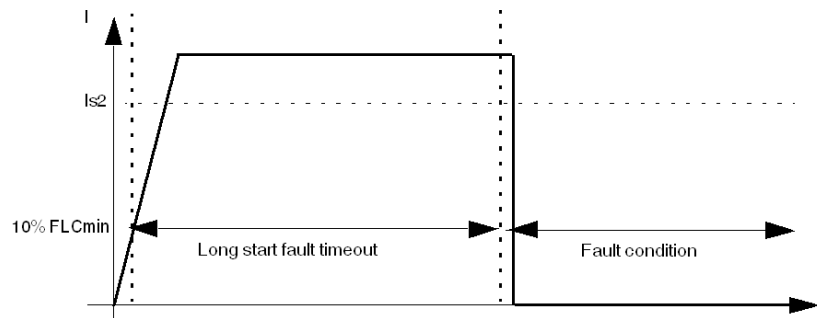

I_{s2} Long start fault threshold

Jam

Description

The jam function detects a locked rotor during run state and signals:

- a warning when the current in any phase exceeds a set threshold, after the motor has reached run state
- a fault when the current in any phase continuously exceeds a set threshold for a specified period of time, after the motor has reached run state

The jam function is triggered when the motor is jammed during run state and stops, or is suddenly overloaded and draws excessive current.

Fault and warning monitoring can be separately enabled and disabled.

Function Characteristics

The jam function includes the following features:

- 2 thresholds:
 - Warning Threshold
 - Fault Threshold
- 1 fault time delay:
 - Fault Timeout
- 2 function outputs:
 - Jam Warning
 - Jam Fault
- 1 counting statistic:
 - Jam Faults Count

Block Diagram

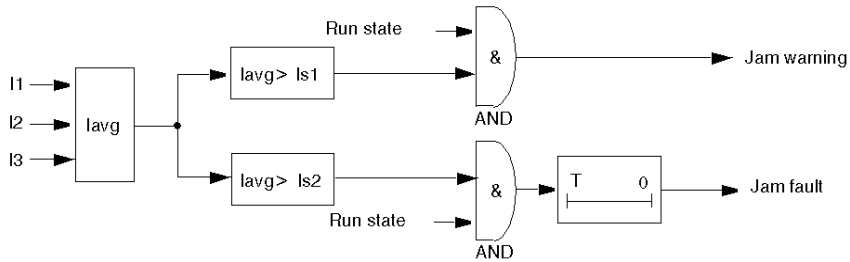

- I1** Phase 1 current
- I2** Phase 2 current
- I3** Phase 3 current
- Is1** Warning threshold
- Is2** Fault threshold
- T** Fault timeout

Parameter Settings

The jam function has the following parameters:

Parameter	Setting Range	Factory Setting
Fault threshold	<ul style="list-style-type: none"> ● 0 to disable the fault detection, or ● 100...800 % of FLA in 1 % increments 	200 % of FLA
Fault timeout	1...30 s in 1 s increments	5 s
Warning threshold	<ul style="list-style-type: none"> ● 0 to disable the warning detection, or ● 100...800 % of FLA in 1 % increments 	200 % of FLA

Technical Characteristics

The jam function has the following characteristics:

Characteristic	Value
Hysteresis	-5 % of Fault threshold or Warning threshold
Trip time accuracy	+/-0.1 s or +/- 5 %

Example

The following diagram describes the occurrence of a jam fault:

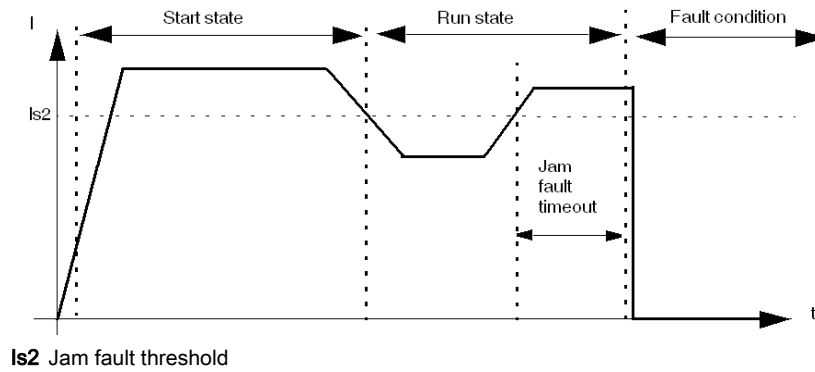

Undercurrent

Description

The undercurrent function signals:

- a warning when the Average Current falls below a set threshold, after the motor has reached run state
- a fault when the Average Current falls and remains below a set threshold for a set period of time, after the motor has reached run state

The undercurrent function is triggered when the motor current falls below the desired level for the driven load, for example, if a drive belt or shaft has broken, allowing the motor to run free rather than under load.

This function has a single fault time delay.

Fault and warning monitoring can be separately enabled and disabled.

Function Characteristics

The undercurrent function includes the following features:

- 2 thresholds:
 - Warning Threshold
 - Fault Threshold
- 1 fault time delay:
 - Fault Timeout
- 1 measure:
 - Average Current
- 2 function outputs:
 - Undercurrent Warning
 - Undercurrent Fault
- 1 counting statistic:
 - Undercurrent Faults Count

Block Diagram

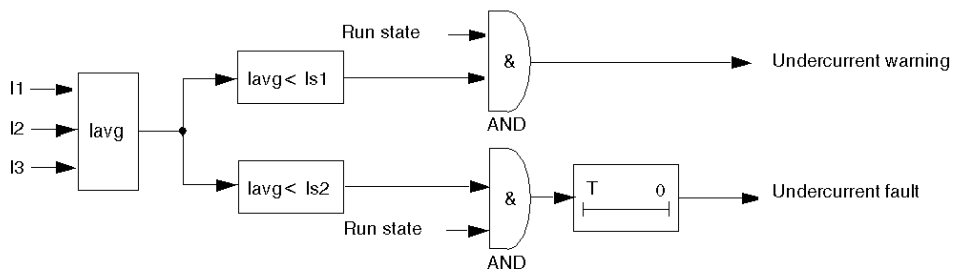

lavg Average current
Is1 Warning threshold
Is2 Fault threshold
T Fault timer delay

Parameter Settings

The undercurrent function has the following parameters:

Parameter	Setting Range	Factory Setting
Fault threshold	<ul style="list-style-type: none"> ● 0 to disable the fault detection, or ● 30...100 % of FLA in 1 % increments 	50 % of FLA
Fault timeout	1...200 s in 1 s increments	1 s
Warning threshold	<ul style="list-style-type: none"> ● 0 to disable the warning detection, or ● 30...100 % of FLA in 1 % increments 	50 % of FLA

Technical Characteristics

The undercurrent function has the following characteristics:

Characteristic	Value
Hysteresis	-5 % of Fault threshold or Warning threshold
Trip time accuracy	+/- 0.1 s or +/- 5 %

Example

The following diagram describes the occurrence of an undercurrent fault:

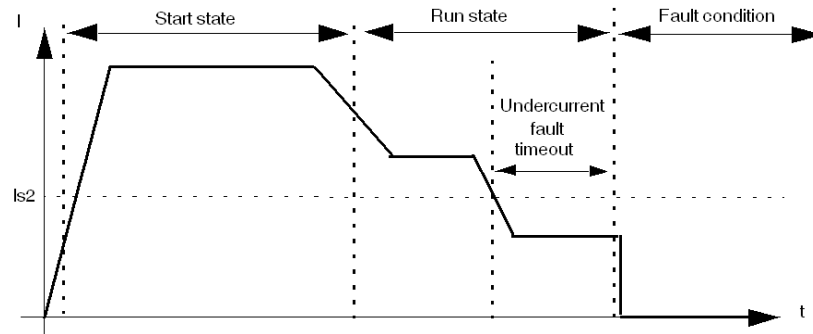

I_{s2} Undercurrent fault threshold

Chapter 4

Motor Control Functions

Overview

This chapter describes the TeSys U starter-controller's operating states, which determine the operating modes, and the fault reset mode (manual, remote, automatic).

What Is in This Chapter?

This chapter contains the following topics:

Topic	Page
Operating States	84
Start Cycle	86
Logic Output Assignment	87
Recovery Mode	89
Reflex Stop Functions	90
Warning Management	92
Detected Fault Management	93
Clear Commands	96

Operating States

Introduction

The TeSys U starter-controller responds to the state of the motor and provides control, monitoring, and protection functions appropriate to each of the motor's operating states. A motor can have many operating states. Some operating states are persistent while others are transitional.

A motor's primary operating states are:

Operating State	Status Parameter	Description
Ready	System Ready = 1 Motor starting = 0 Motor running = 0	<ul style="list-style-type: none"> ● The motor is stopped. ● The TeSys U starter-controller <ul style="list-style-type: none"> ○ detects no fault, and ○ is ready to start.
Not Ready	System Ready = 0 Motor starting = 0 Motor running = 0	<ul style="list-style-type: none"> ● The motor is stopped. ● The TeSys U starter-controller detects a fault.
Start	System Ready = 1 Motor starting = 1 Motor running = 1	<ul style="list-style-type: none"> ● The motor starts. ● The TeSys U starter-controller <ul style="list-style-type: none"> ○ detects that current has reached 10 % FLA, ○ detects that current has not both crossed and re-crossed the long start fault threshold, and ○ continues to count down the long start fault timer.
Run	System Ready = 1 Motor starting = 0 Motor running = 1	<ul style="list-style-type: none"> ● The motor is running. ● The TeSys U starter-controller detects that current has both crossed and re-crossed the long start fault threshold before the TeSys U starter-controller fully counted down the long start fault timer.

Operating State Chart

The operating states of the TeSys U starter-controller firmware, as the motor progresses from Off to Run state, are described below. The TeSys U starter-controller verifies current in each operating state. The TeSys U starter-controller can transition to an internal fault condition from any operating state.

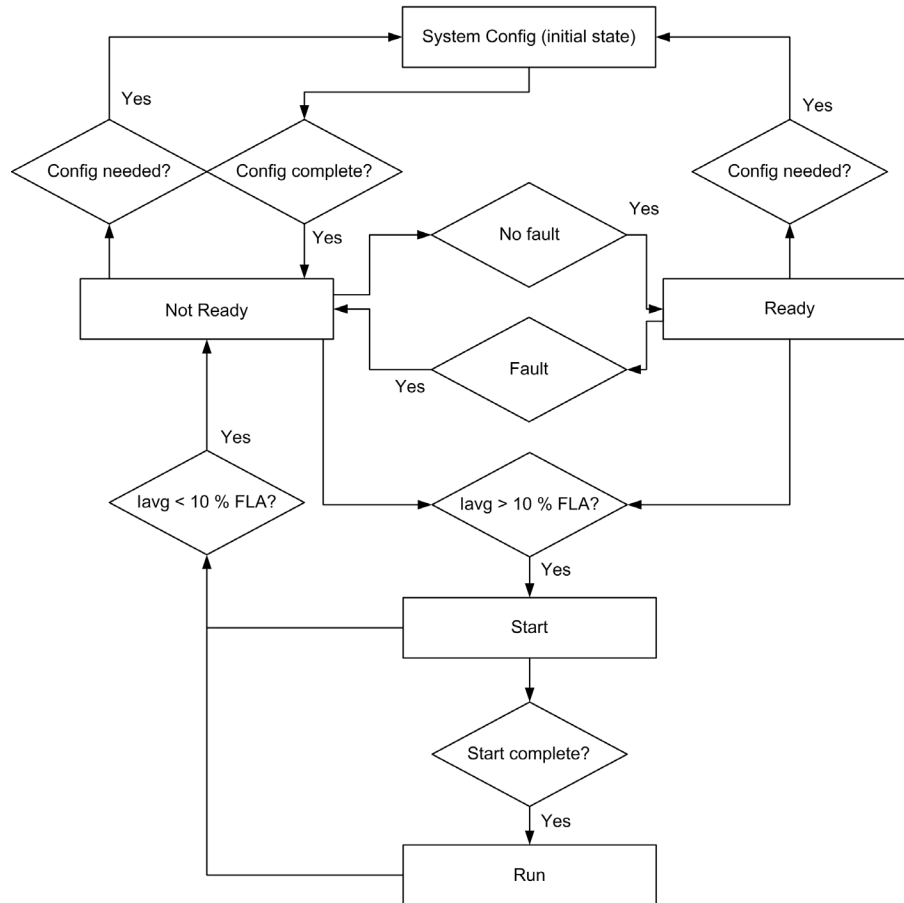

Protection Monitoring by Operating States

The motor operating states, and the fault and warning protections provided by the TeSys U starter-controller while the motor is in each operating state (denoted with an X), are described below. The TeSys U starter-controller can transition to an internal fault condition from any operating state.

Monitored Fault/Warning	Operating States				
	Sys Config	Ready	Not Ready	Start	Run
Minor internal faults	√	√	√	√	√
Major internal faults	√	√	√	√	√
Thermal overload	–	√	√	√	√
Short-circuit	–	√	√	√	√
Magnetic	–	–	–	√	√
Ground Fault	–	–	–	√	√
Current Phase Imbalance	–	–	–	√	√
Long Start	–	–	–	√	–
Jam	–	–	–	–	√
Undercurrent	–	–	–	–	√
√ Monitored					
– Not monitored					

Start Cycle

Description

The start cycle is the time period allowed for the motor to reach its normal FLA level. The TeSys U starter-controller measures the start cycle in seconds, beginning when it detects an average phase current equal to 10 % of FLA.

During the start cycle, the TeSys U starter-controller compares:

- detected current against the configurable Long Start Fault Threshold parameter, and
- elapsed start cycle time against the configurable Long Start Fault Timeout parameter.

For information about the long start protection function, see *Long Start*, page 76.

2 Typical Start Cycles

The 2 typical start cycles are defined as follows:

- The start cycle ends when the current falls below the Long start fault threshold (start cycle 1).
- The start cycle ends when the long start timeout has elapsed (start cycle 2).

Start cycle 1:

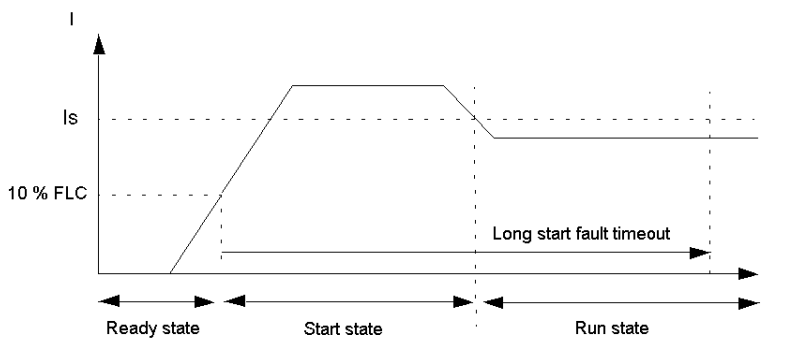

I_s Long start fault threshold

Start cycle 2:

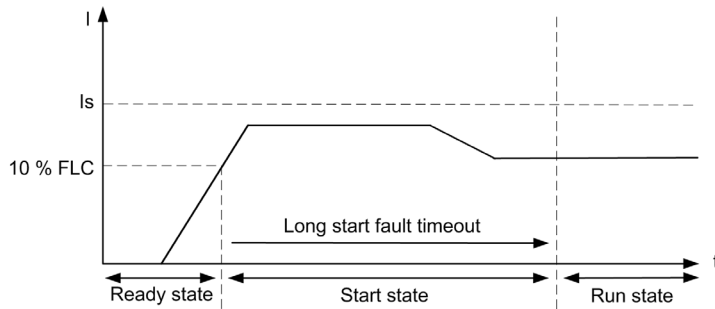

I_s Long start fault threshold

Start Cycle Interrupted by Long Start Fault

The start cycle is interrupted by a Long start fault when the current remains above the Long start fault threshold at the end of the long start timeout.

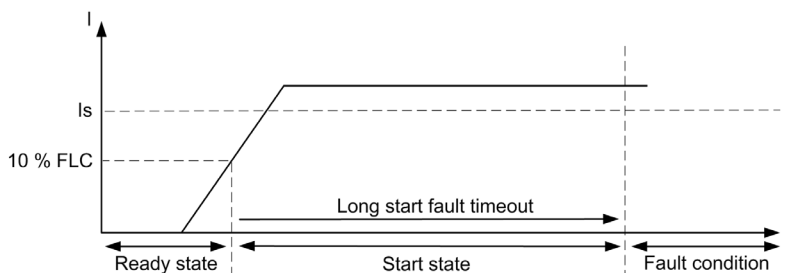

I_s Long start fault threshold

Logic Output Assignment

Logic Outputs

3 logic outputs are available on each LULC** communication module: OA1, OA3, and LO1.

Depending on application requirements (signaling, run, stop, and so on), it is possible to assign NO or NC behavior to each logic output OA1, OA3, and LO1.

Assignment of Outputs OA1, OA3, LO1

Each logic output OA1, OA3, and LO1 can be assigned to one of the functions listed in the table below.

⚠ WARNING	
UNINTENDED EQUIPMENT OPERATION	
The application of this product requires expertise in the design and programming of control systems. Only persons with such expertise should be allowed to program and apply this product.	
Follow all local and national safety codes and standards.	
Failure to follow these instructions can result in death, serious injury, or equipment damage.	

Value	Description of Assigned Value	LUCA/ LUCL	LUCB/ LUCC/ LUCD	LUCM
0	The corresponding output is forced to 0	√	√	√
1	The corresponding output is forced to 1	√	√	√
2	Output controlled by the associated logic output command	√	√	√
3	Thermal overload fault	–	√	√
4	Thermal overload warning	–	√	√
5	Copy of the ON button position	√	√	√
6	Copy of the Trip button position	√	√	√
7	Copy of the contactor position	√	√	√
8	Reflex stop 1: forward	√	√	√
9	Reflex stop 1: reverse	√	√	√
10	Reflex stop 2: forward	√	√	√
11	Reflex stop 2: reverse	√	√	√
12	Motor run forward command (default OA1 value)	√	√	√
13	Motor run reverse command (default OA3 value)	√	√	√
14	Short-circuit fault	–	√	√
15	Magnetic fault	–	√	√
16	Ground fault	–	–	√
17	Thermal overload fault	–	√	√
18	Long start fault	–	–	√
19	Jam fault	–	–	√
20	Phase imbalance fault	–	–	√
21	Undercurrent fault	–	–	√
22	Shunt fault	–	–	√
23	Test fault	–	–	√
24	HMI port fault	–	–	√
25	Control unit internal fault	–	√	√
26	Module identification or internal communication fault	–	–	√
27	Communication module internal fault	√	√	√
28–31	<i>(Reserved)</i>	–	–	–
32	Ground fault warning	–	–	√
33	Thermal overload warning	–	√	√

Value	Description of Assigned Value	LUCA/ LUCL	LUCB/ LUCC/ LUCD	LUCM
34	Long start warning	–	–	√
35	Jam warning	–	–	√
36	Phase imbalance warning	–	–	√
37	Undercurrent warning	–	–	√
38–39	<i>(Reserved)</i>	–	–	–
40	HMI port warning	–	–	√
41	Control unit internal temperature warning	–	–	√
42	Module identification or internal communication warning	–	–	√
43–44	<i>(Reserved)</i>	–	–	–
45	Communication module warning	√	√	√

Recovery Mode

Definition

If you use the Run forward and Run reverse command bits to control outputs OA1–OA3, enabling the recovery mode allows you to lock the motor and prevent it restarting following the occurrence of certain events:

- Loss followed by restoration of 24 Vdc (outputs OA1–OA3).
- Change in position of rotary knob on power base followed by return to ON position.

When one of these events occurs, command bits Run forward and Run reverse (and outputs OA1–OA3) are forced to 0 automatically. After these events have disappeared, control of the motor can be restored by resetting the Run command before sending a new Run command.

WARNING

AUTOMATIC RESTART OF THE MOTOR

Cyclic writing to command bits (for example, an LUFPP gateway in its predefined configuration) must be used with caution.

If the recovery mode is disabled, the application program must request that the command bits Run forward and Run reverse are written to 0.

Otherwise, the motor will restart automatically when the 24 Vdc is restored or when the rotary knob is turned to ON position.

Failure to follow these instructions can result in death, serious injury, or equipment damage.

Reflex Stop Functions

Introduction

The reflex stop functions provide accurate repeated position control, unhindered by the bus and PLC scan times.

There are 2 types of reflex stop function:

- Reflex1: Reflex stop 1 function, with 1 sensor connected to LI1, logic input of the LULC** communication module
- Reflex2: Reflex stop 2 function, with 2 sensors connected to LI1 and LI2, logic inputs of the LULC** communication module

Logic Output Assignment

To use the reflex stop functions, the logic outputs OA1 or OA1 and OA3, which control the motor, must first be assigned.

The assignment values for the reflex stop 1 function are:

- Reflex stop 1: forward
- Reflex stop 1: reverse

The assignment values for the reflex stop 2 function are:

- Reflex stop 2: forward
- Reflex stop 2: reverse

Description of Reflex Stop 1

The sensor no. 1, connected to the logic input LI1, directly controls motor stopping.

The detection of a rising edge on LI1 opens the outputs assigned to the Reflex stop 1, and thus stops the motor.

After a new run command (stop command then run command), the motor restarts in the chosen direction (run forward or run reverse) even if something is still detected (LI1 = 1).

NOTE: In the case of a reversing starter, the reflex stop 1 function works in both directions.

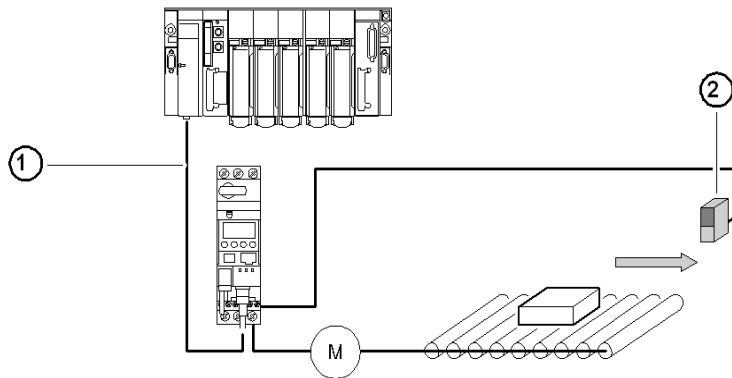

- 1 Bus
- 2 Sensor no. 1 (LI1)

Timing Sequence of Reflex Stop 1

The following diagram provides an example of the Reflex stop 1 timing sequence, with:

- OA1 assigned to Reflex stop 1 forward, and
- OA3 assigned to Reflex stop 1 reverse.

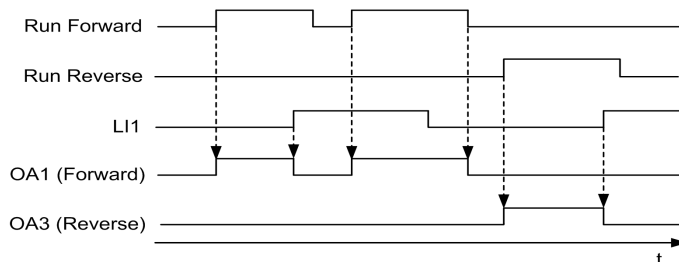

Description of Reflex Stop 2

The sensor no. 1 is connected to the logic input LI1. The detection of a rising edge on LI1 opens the output assigned to Reflex stop 2: forward.

The sensor no. 2 is connected to the logic input LI2. The detection of a rising edge on LI2 opens the output assigned to Reflex stop 2: reverse.

After a new run command (stop command then run command), the motor restarts in the chosen direction (run forward or run reverse) even if something is still detected (LI1 or LI2 = 1).

NOTE: Sensor no. 2 (LI2) does not affect forward mode and sensor no. 1 (LI1) does not affect reverse mode.

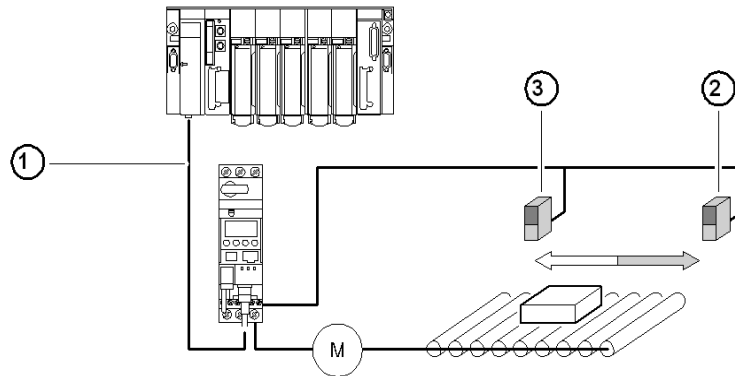

- 1 Bus
- 2 Sensor no. 1 (LI1)
- 3 Sensor no. 2 (LI2)

Timing Sequence of Reflex Stop 2

The following diagram provides an example of the Reflex stop 2 timing sequence, with:

- OA1 assigned to Reflex stop 2 forward, and
- OA3 assigned to Reflex stop 2 reverse.

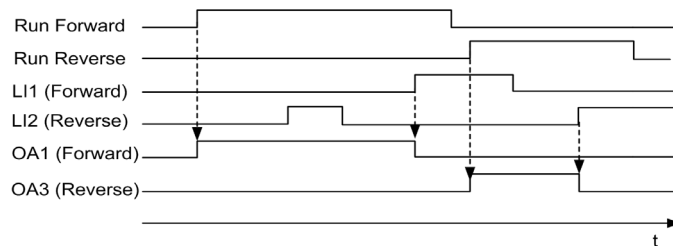

Warning Management

Overview

A warning condition detected by the TeSys U starter-controller indicates corrective action that may be required to prevent a problem condition from occurring. If left unresolved, a warning may lead to a fault condition.

A warning is not latched and does not need to be acknowledged by a reset command, except the Network port communication loss warning.

TeSys U Response to a Warning

The response of the TeSys U starter-controller to a warning include the following:

- A warning status bit is set in a warning parameter.
- A text message is displayed on the LUCM HMI.
- A warning status indicator is displayed in the configuration software.

Network Port Communication Loss Warning

After detection of the Network port communication loss, the TeSys U starter-controller switches to Fallback mode.

According to the fallback mode selected (see *Network Port Communication Loss Fallback Strategy*, [page 55](#)):

- The Network port communication loss warning must be acknowledged by dedicated reset command.
- The motor stops.
- The fault LED flashes red 2 times per second on the LULC** communication module.

Warning List

The following table lists all warnings detected by the TeSys U starter-controllers, with:

- the code, an identifier used in the communication registers, and
- the warning name.

Code	Warning
3	Ground fault warning
4	Thermal overload warning
5	Long start warning
6	Jam warning
7	Phase imbalance warning
8	Undercurrent warning
10	HMI port communication loss warning
11	LUCM internal temperature warning
12	LUCM warning (communication module not recognized or unsuccessful communications with the module)
109	Network port communication loss warning

Detected Fault Management

Overview

When the TeSys U starter-controller detects a fault condition and activates the appropriate response, the fault becomes latched. It remains latched, even if the underlying fault condition is eliminated, until acknowledged by a reset command.

TeSys U Response to a Detected Fault

Responses of the TeSys U starter-controller after detection of a fault include the following:

- The motor stops by either Trip or Drop-out:
 - Trip: the breaker trips
 - Drop-out: the contactor opens
- The fault LED is On on the LULC** communication module.
- A fault status bit is set in a fault parameter.
- A text message is displayed on LUCM HMI.
- A fault status indicator is displayed in the configuration software, if connected.

Reset Modes

The user can select the fault reset mode from 3 modes:

- manual (by default)
- remote
- automatic

NOTE:

The Automatic and Remote fault reset modes are available only on a TeSys U starter-controller:

- with an LUCB, LUCC, or LUCD control unit in association with an LUFDA** module, or
- with an LUCB, LUCC, LUCD or LUCM control unit in association with an LULC** communication module.

Reset Actions

According to the fault reset mode selected and the type of detected fault, the reset action to acknowledge a detected fault can be one of the following:

- A manual action: reset by manual action on the power base handle
- A remote action: reset by
 - Reset command through the communication network
 - Action on the **ENT** key on the LUCM control unit
 - Power cycle of the TeSys U starter-controller
- An automatic action: automatic reset after a timeout set by the Thermal Overload Fault Reset Timeout parameter

Detected Fault List

The following tables list all faults detected by the TeSys U starter-controllers, with

- the fault code, an identifier used in
 - the communication registers
 - the history registers (except for internal faults or Shunt Trip fault)
- the fault name

And, according to the Fault reset mode selected (M=Manual, R=Remote, or A=Automatic):

- the TeSys U response after detection of the fault, and
- the reset action to be performed by the user to acknowledge the fault.

Faults Detected by Protection Functions

Code	Detected Fault	Reset Mode			TeSys U Response	Reset Action
		M	R	A		
1	Short circuit	√	√	√	Trip	Manual action
2	Magnetic	√	√	√	Trip	Manual action
3	Ground fault	√	√	√	Trip	Manual action
4	Thermal overload	√	–	–	Trip	Manual action
		–	√	–	Drop-out	Remote action
		–	–	√	Drop-out	Automatic action
5	Long start	√	–	–	Trip	Manual action
		–	√	–	Drop-out	Remote action
		–	–	√	Drop-out	Automatic action
6	Jam	√	–	–	Trip	Manual action
		–	√	–	Drop-out	Remote action
		–	–	√	Drop-out	Automatic action
7	Phase imbalance	√	–	–	Trip	Manual action
		–	√	–	Drop-out	Remote action
		–	–	√	Drop-out	Automatic action
8	Undercurrent	√	–	–	Trip	Manual action
		–	√	–	Drop-out	Remote action
		–	–	√	Drop-out	Automatic action

Faults Triggered by the User

To test and check its installation, the user can trigger fault commands

- through the communication network, or
- via the HMI of the LUCM control unit.

Code	Detected Fault	Reset Mode			TeSys U Response	Reset Action
		M	R	A		
9	Shunt fault	√	√	√	Trip	Manual action
10	Test fault	√	–	–	Trip	Manual action
		–	√	–	Drop-out	Remote action
		–	–	√	Drop-out	Automatic action

HMI Port Faults Detected by LUCM Control Unit

Code	Detected Fault	Reset Mode			TeSys U Response	Reset Action
		M	R	A		
11	HMI Port Communication Loss with HMI port watchdog action setting = Drop-out	√	√	√	Drop-out	Remote action
12	HMI Port Communication Loss with HMI port watchdog action setting = Trip	√	√	√	Trip	Manual action

LUCM Internal Temperature Detected Fault

Code	Detected Fault	Reset Mode			TeSys U Response	Reset Action
		M	R	A		
51	LUCM internal temperature (<i>see page 53</i>)	√	√	√	Trip	Manual action

Internal Faults Detected by LUCM Control Unit

For more information about internal faults, refer to TeSys U internal faults (*see page 52*).

Code	Detected Fault	Reset Mode			TeSys U Response	Reset Action
		M	R	A		
52	ASIC1 read-after-write fault	√	√	√	Trip	Manual action
53	ASIC1 initialize check fault	√	√	√	Trip	Manual action
54	ASIC2 watchdog or ASIC2 DTH over temperature	√	√	√	Trip	Manual action
55	Stack overflow fault	√	√	√	Trip	Manual action
56	RAM fault	√	√	√	Trip	Manual action
57	ROM (flash) fault	√	√	√	Trip	Manual action
58	Hardware watchdog	√	√	√	Trip	Manual action
59	Current detected while OFF	√	√	√	Trip	Manual action
64	FRAM strings checksum fault	√	√	√	Trip	Manual action
–	EEPROM checksum fault	√	√	√	Trip	Manual action
–	Current sensor loss fault	√	√	√	Trip	Manual action

Wiring Faults Detected by LUCM Control Unit

Code	Detected Fault	Reset Mode			TeSys U Response	Reset Action
		M	R	A		
60	Phase configuration error	√	√	√	Trip	Manual action
61	Undetected base change	√	√	√	Trip	Manual action
62	A2 missing	√	√	√	Trip	Manual action
63	A1 overvoltage	√	√	√	Trip	Manual action

Communication Module Faults

Code	Detected Fault	Reset Mode			TeSys U Response	Reset Action
		M	R	A		
100	Write-to-EEPROM fault	√	√	√	Drop-out	Power cycle
101	Communication fault with LUCM control unit	√	√	√	Drop-out	Power cycle
102	Checksum-on-EEPROM fault	√	√	√	Drop-out	Remote action
104	EEPROM configuration fault	√	√	√	Drop-out	Remote action

Clear Commands

Overview

Clear commands allow the user to clear specific categories of TeSys U parameters:

- Clear all parameters
- Clear the statistics

The Clear commands can be delivered from:

- a PC running SoMove with the TeSys U DTM
- the LUCM control unit
- a PLC via the network port

Clear All Command

If you want to change the configuration of the TeSys U starter-controller, you may want to clear all existing parameters in order to return to factory settings before setting new parameters for TeSys U.

The Clear All Command forces TeSys U to enter configuration mode. A power cycle is performed to restart correctly in this mode. This enables TeSys U to pick up the new values for the cleared parameters.

NOTE: When you clear all parameters, static characteristics are also lost. Only the LUCM internal temperature max parameter is not cleared after a clear all command.

Clear Statistics Command

Statistics parameters are cleared without the TeSys U starter-controller being forced into configuration mode. Static characteristics and settings are preserved.

The LUCM internal temperature max parameter is the only statistics parameter that is not cleared after a clear statistics command.

Chapter 5

Communication Functions

Overview

This chapter presents the general settings available in the TeSys U DTM for each communication protocol, and the configuration of the HMI port on the LUCM control unit.

What Is in This Chapter?

This chapter contains the following topics:

Topic	Page
Configuration of the LULC•• Network Port	98
Configuration of the Tesys U LUCM HMI Port	100

Configuration of the LULC•• Network Port

Introduction

The LULC•• network port configuration depends on the communication module and protocol.

Depending on the communication module, the configuration parameters can be set using:

- hardware switches on the communication module, and/or
- the TeSys U DTM or communication or the LUCM HMI.

LULC031 and LULC033 Configuration

Configuration of the LULC031 and LULC033 Modbus communication module:

- 1 hardware setting (Address)
- 1 software setting (Timeout duration)

Parameter	Setting Range	Default Value
Address	1...31	1
Timeout duration	<ul style="list-style-type: none"> • 0 to disable the timeout, or • 0.01...655.35 s in 0.01 s increments 	60 s

LULC07 Configuration

Configuration of the LULC07 Profibus DP communication module:

- 1 hardware setting (Address)

Parameter	Setting Range	Default Value
Address	1...125	1

LULC08 Configuration

Configuration of the LULC08 CANopen communication module:

- 2 hardware settings (Address + Transmission speed)

Parameter	Setting Range	Default Value
Address	1...127	1
Transmission speed	<ul style="list-style-type: none"> • 10 kBaud • 20 kBaud • 50 kBaud • 125 kBaud • 250 kBaud • 500 kBaud • 800 kBaud • 1000 kBaud 	250 kBaud

LULC09 Configuration

Configuration of the LULC09 DeviceNet communication module:

- 2 hardware settings (Address + Transmission speed)

Parameter	Setting Range	Default Value
Address	1...63	63
Transmission speed	<ul style="list-style-type: none"> • 125 kBaud • 250 kBaud • 500 kBaud • Autobaud 	125 kBaud

LULC15 Configuration

Configuration of the LULC15 Advantys STB communication module:

- no parameters required thanks to auto-addressing and autobaud functions.

Network Port Fallback Setting

Network port fallback setting is used to adjust the fallback mode in case of a loss of communication with the PLC. This setting must be configured whatever the protocol. Refer to Network Port Communication Loss Fallback Strategy (*see page 55*).

Configuration of the Tesys U LUCM HMI Port

HMI Port

The HMI port on the LUCM control unit is a Modbus slave RS 485 communication port.

 **WARNING**

MISUSE OF COMMUNICATION PORT

Communication ports should only be used for non-critical data transfer.

Contactors and current level monitoring data can be delayed by transmission timelag and must not be used for critical command decisions.

The Off or Pause functions must not be used for emergency stops or for critical command applications.

Failure to follow these instructions can result in death, serious injury, or equipment damage.

Communication Parameters

Use the TeSys U DTM or the LUCM HMI to modify the following HMI port communication parameters:

- HMI port address setting
- HMI port baud rate setting
- HMI port parity setting
- HMI port write permission setting
- HMI port watchdog action setting

HMI Port Address Setting

The HMI port address can be set between 1 (default) and 247.

NOTE: Address 127 is reserved for a point-to-point connection. It must not be used for a network with more than one multifunction control unit. Address 127 is reserved for a point-to-point connection with configuration software such as SoMove with the TeSys U DTM. Communication is possible in this way without knowing the address of the multifunction control unit. All multifunction control units respond to address 127.

HMI Port Baud Rate Setting

Possible transmission rates are:

- 1200 Baud
- 4800 Baud
- 9600 Baud
- 19,200 Baud (default)

HMI Port Parity Setting

The parity can be selected from:

- Even (default)
- None

Parity and bit behavior are linked:

If the parity is...	Then the total number of bits is...
Even	11 bits (1 start bit, 8 data bits, 1 parity bit, and 1 stop bit)
None	10 bits (1 start bit, 8 data bits, and 1 stop bit)

HMI Port Write Permission Setting

The write permission parameter is used to enable the write command of internal configuration registers.

The function is disabled by default. If the function is disabled, read commands remain valid for all the registers.

HMI Port Watchdog Action Setting

When the communication through the HMI port on the LUCM control unit is lost, the behavior of the TeSys U starter-controller is defined by the value set for the HMI port watchdog action setting.

For more information, refer to HMI port communication loss (*see page 56*).



A

average current, *47*

C

clear commands, *96*

command

clear all, *96*

clear statistics, *96*

communication loss, *55*

control unit

internal temperature, *53*

current

average, *47*

current phase imbalance

metering and monitoring function, *48*

motor protection function, *73*

current ratio

L1, *45*

L2, *45*

L3, *45*

D

detected fault management, *93*

F

fault

device monitoring, *51*

management, *93*

wiring, *54*

fault and warning counters, *59*

fault history, *60*

FLA (full load amps), *65*

G

ground current

metering and monitoring function, *46*

motor protection function, *71*

H

HMI port

LUCM, *100*

I

internal fault, *52*

internal temperature

control unit, *53*

J

jam, *78*

L

L1 current ratio, *45*

L2 current ratio, *45*

L3 current ratio, *45*

line currents, *45*

logic output assignment, *87*

long start, *76*

M

magnetic, *70*

minimum wait time, *50*

motor protection functions, *64*

motor statistics, *61*

O

operating state, *84*

R

recovery mode, *89*

reflex stop, *90*

S

short-circuit, *69*

shunt fault command, *57*

start cycle, *86*

starter-controller

internal fault, *52*

T

thermal capacity level, *49*

thermal overload, *66*

thermal overload fault, *94*

U

undercurrent, *80*

W

warning management, *92*

wiring fault, *54*



1672613EN-02

Schneider Electric Industries SAS

35, rue Joseph Monier
CS30323
F - 92506 Rueil Malmaison Cedex

www.se.com

As standards, specifications and designs change from time to time, please ask for confirmation of the information given in this publication.

01/2020