

IP65 Moisture-proof diffuser luminaire

IP65 LED Moisture proof luminaire with opal diffuser for indoor and covered outdoor installation. Innovative design with extra long bracket sliders (400 mm) for ease of installation making it an ideal refurbishment luminaire. Made of high quality polycarbonate (UV stabilised), the design is streamlined and clip free, whilst still providing easy but secure access to the driver. Integrated microwave sensor with corridor function for optional sender - sender wiring. Total luminous flux: 6300 lm, Luminaire input power: 51 W, Luminaire efficacy: 124 lm/W, CCT: 4000K, Lifetime: 50.000hrs @L80, Colour Rendering: CRI > 80. Chromaticity tolerance (initial MacAdam): 4, Impact strength: IK08. Tool-free installation, BESA compatible. Available accessories: Plug&Play Emergency kit for 3 hour emergency conversion (self- and manual test) and suspension kit. Lumen package adjustable on site by 3 steps (FLEX1: 6300 lm (51W), FLEX2: 5200 lm (41W), FLEX3: 4200 lm (33W). Detailed power setting information available on [www.THORNeco.com](http://www.THORNeco.com). Dimensions: 1535 x 94 x 76 mm, weight: 1.9 kg.

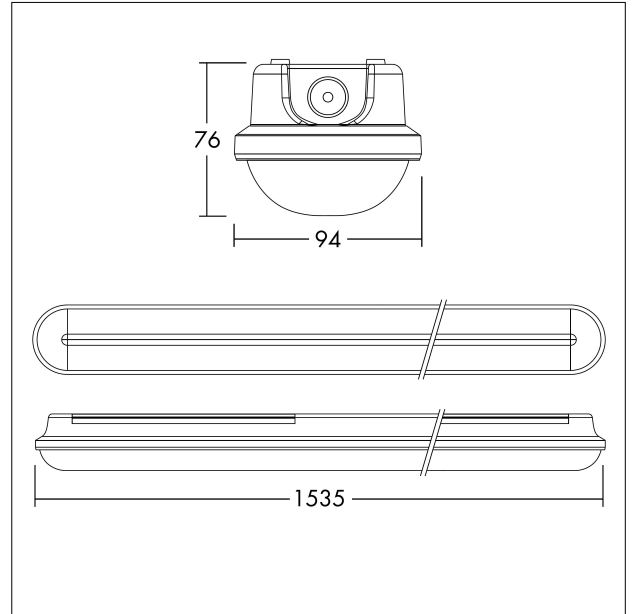

TE\_JULIEF\_F\_PERSP\_ON.jpg



TE\_JULIEF\_M\_1500.wmf

Light Distribution

STD - standard

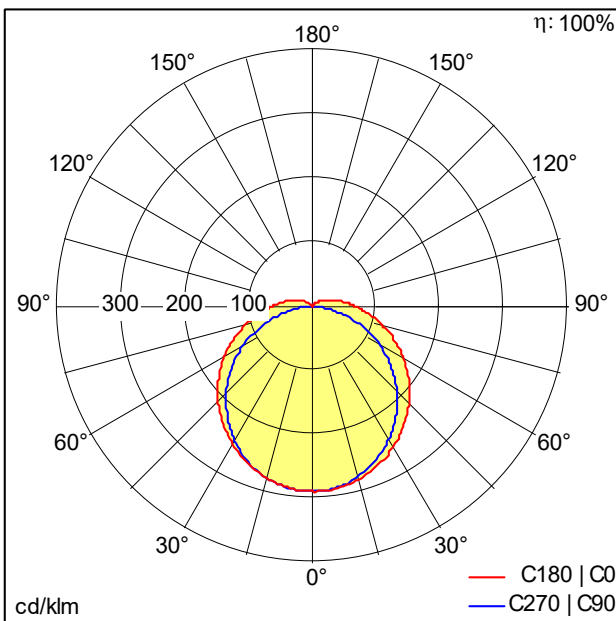

TE\_JULIE\_FLEX\_1500\_6300\_840\_FLEX1.ltd

- Light Source: LED
- Luminaire luminous flux\*: 6300 lm
- Total emergency luminous flux: 504 lm
- Luminaire efficacy\*: 124 lm/W
- Colour Rendering Index min.: 80
- Correlated colour temperature\*: 4000 Kelvin
- Chromaticity tolerance (initial MacAdam): 4
- Rated median useful life\*: L80 50000 h at 25 °C
- Ballast: 1x LED\_Con
- Luminaire input power\*: 51 W Power factor = 0.9
- Dimming: Fixed output
- Maintenance category CIE 97: E - Dust-proof IP5X
- Total harmonic distortion (THD): 20.00 %

This product contains a light source of energy efficiency class D.

All values marked with an \* are rated values. Connected electrical load and luminous flux are subject to an initial tolerance of +/- 10%, the most similar colour temperature is subject to an initial tolerance of +/- 150K. Unless stated otherwise, the values apply to an ambient temperature of 25°C.