

# Product Data Sheet

## GW46233

46 Range

Range of Watertight surface-mounting boards made metallic material. In compliance with IEC 61439-1 (CEI 17/113), IEC 61439-2 (CEI 17/114), IEC 60670-1 (CEI 23/48), IEC 60670-24 (CEI 23/49) e IEC 62208 (CEI 17-87). Available in 7 sizes, transparent and black door versions with IP55 protection degree. Fast&Easy accessories, made in metal, allow the installation of modular devices and moulded-case circuit breakers up to 250A into the boards, reducing assembly times by up to 40%. Indicated for automation and distribution for indoor applications.

Insulation class	Pre-arranged with earth terminal	Colour	Grey RAL 7035
Nominal dim. LxHxD (mm)	405x500x200	IP degree	IP55
Material	Sheet metal from 10/10 to 15/10, painted with epoxy-polyester powders	Mechanical resistance	IK08
No. locks	2	No. of modules EN 50022	54 (18x3)
Application	For indoor use	Dispersible power A (W)	106
Dispersible power B (W)	80	Functional dim. LxHxD (mm)	405x500x200
Operating temperature	-25 +60 °C	Type of material	Metal
Electrocod	0320	Standard	EN 61439-1, EN 61439-2, EN62208, EN 60670-1, IEC 60670-24
Family	46 QM	Maximum rated insulation voltage (Ui)	690 V
Type of door	Door with tempered glass window		

### BEHAVIOUR WITH CHEMICAL AND ATMOSPHERIC AGENTS

Saline solution	Acids		Bases		Solvents				Mineral oil	UV rays
	Concentrated	Diluted	Concentrated	Diluted	Hexane	Benzol	Acetone	Ethyl alcohol		
Limited resistance	Limited resistance	Limited resistance	Not resistant	Not resistant	Resistant	Limited resistance	Not resistant	Resistant	Resistant	Resistant

### DIMENSIONAL

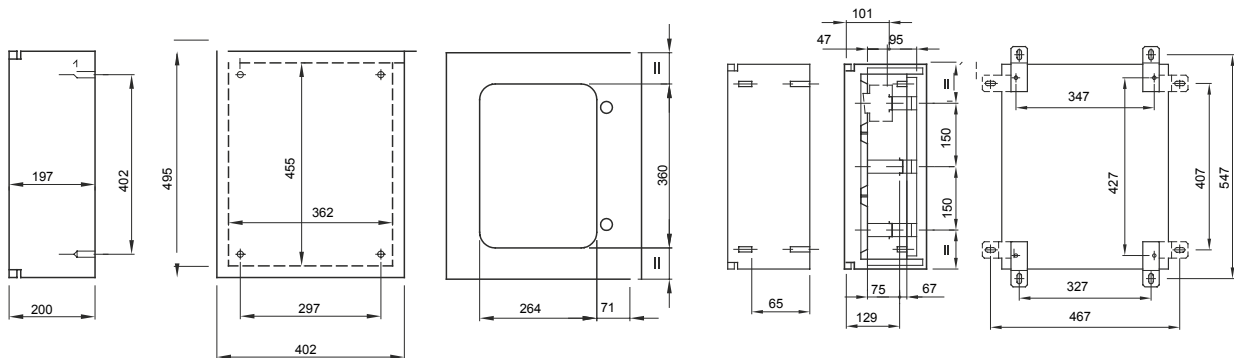

### TECHNICAL SYMBOLOGY

IP

IP55

IK

IK08



### STANDARDS/APPROVALS



GEWISS S.p.A. Via A. Volta, 1  
24069 Cenate Sotto - Bergamo - Italy  
tel. +39 035 94 61 11 fax +39 035 94 69 09

www.gewiss.com  
sat@gewiss.com  
Last update 20/04/2023

Data, measures, designs and pictures are shown only as informative purposes, and could be changed without previous notice