

# CHORUS

# GEWISS

## KNX 2-channel universal dimmer 400W - DIN rail mounting



**GWA9303**

## **Technical Manual**

# Contents

<b>1</b>	<b>Introduction.....</b>	<b>5</b>
<b>2</b>	<b>Application .....</b>	<b>5</b>
2.1	Association limits.....	5
<b>3</b>	<b>“General” menu .....</b>	<b>6</b>
3.1	Parameters .....	6
3.1.1	Function of manual push button .....	6
3.1.2	Manual operation of channels.....	7
<b>4</b>	<b>“Channel CH1: Function selection” menu.....</b>	<b>8</b>
4.1	Parameters .....	8
4.1.1	Adjust dimming value limits .....	8
4.1.2	Adjust soft switching .....	8
4.1.3	Adjust lock function.....	9
4.1.4	Activate forced mode.....	9
4.1.5	Activate scenes .....	9
4.1.6	Participation in central objects.....	9
4.1.7	Adjust feedback.....	11
4.1.8	Activate hour meter.....	11
4.1.9	Activate diagnostic messages .....	11
4.2	“Dimming response” parameters menu.....	12
4.2.1	Load selection .....	12
4.2.2	Start-up time .....	13
4.2.3	Minimum dimming value.....	13
4.2.4	Dimming time 1, from 0% to 100% .....	13
4.2.5	Dimming time 2, from 0% to 100% .....	13
4.2.6	Dimming time 3, from 0% to 100% .....	13
4.2.7	When receiving a switch order (1 bit) .....	14
4.2.8	When receiving a dimming order (4 bit).....	14
4.2.9	When receiving an absolute value (8 bit).....	15
4.2.10	Switch-on value .....	15
4.2.11	Switching ON/OFF with a 4-bit dim telegram.....	15
4.3	“Loss and restoration of power parameters menu .....	17
4.3.1	Status at download and bus failure.....	17
4.3.2	Status at restoration of mains or bus power .....	17
4.4	Objects available with parameters default value .....	18
4.4.1	Objects for channels 1/2.....	18
4.4.2	Common objects.....	19
4.5	“Dimming value limits” menu parameters.....	21
4.5.1	Perform limitation when writing object .....	21
4.5.2	Limit applies to switching command (1 bit) .....	22
4.5.3	Limit applies to relative dimming (4 bit).....	22
4.5.4	Limit applies to absolute dimming (8 bit).....	22
4.5.5	Limit applies to soft switching .....	22
4.6	“Soft switching parameters menu.....	23
4.6.1	Time for Soft ON.....	23
4.6.2	Dimming value after Soft ON.....	23
4.6.3	Time between Soft ON and Soft OFF.....	23
4.6.4	Time for Soft OFF.....	24
4.7	“Lock function parameters menu.....	25
4.7.1	Lock telegram.....	25
4.7.2	Reaction when setting the lock.....	25
4.7.3	Reaction when unlocking.....	25
4.8	“Forced mode parameters menu.....	27
4.8.1	Format of forced object.....	27
4.8.2	Parameters with “Format of forced object” = 1 Bit.....	27
4.8.3	Parameters with “Format of forced object” = 2 Bit .....	28
4.8.4	Parameters with “Format of forced object” = 1 Byte (%) .....	30
4.9	“Scenes parameters menu .....	31

4.9.1	Lock telegram for scenes.....	31
4.9.2	All scene statuses of channel.....	32
4.9.3	Participation in object Central scene.....	32
4.9.4	Channel reacts to.....	32
4.9.5	Allocated dimming value.....	32
4.9.6	Response when receiving scene numbers.....	33
4.9.7	Permit teach-in.....	33
4.10	“Feedback parameters menu.....	34
4.10.1	Format of 1-bit feedback.....	34
4.10.2	Send 1-bit feedback cyclically.....	34
4.10.3	Send 8-bit feedback.....	35
4.10.4	Send 8-bit feedback cyclically.....	35
4.10.5	Time for cyclical transmission of feedback (if available).....	35
4.11	“Hour meter and service” menu parameters.....	36
4.11.1	Type of hour meter.....	36
4.11.2	Report operating hours at change (0..100h, 0 = no report).....	36
4.11.3	Transmit operating hours cyclically.....	37
4.11.4	Service interval (0..2000, x 10h).....	37
4.11.5	Report time to service when changed (0..100h, 0 = no report).....	37
4.11.6	Transmit time to service cyclically.....	37
4.11.7	Report service cyclically.....	38
4.11.8	Time for cyclical transmission (time to service).....	38
4.12	“Diagnostic messages parameters menu.....	39
4.12.1	Send general error cyclically.....	39
4.12.2	Send short circuit cyclically.....	39
4.12.3	Send excess temperature cyclically.....	40
4.12.4	Send mains failure cyclically.....	40
4.12.5	Send load type cyclically.....	40
4.12.6	Cycle time for all diagnostic messages (if used).....	40
<b>5</b>	<b>“Channel CH2: Function selection menu.....</b>	<b>41</b>
5.1	Parameters.....	41
5.1.1	Copy main parameters from channel CH1.....	41
<b>6</b>	<b>Annex 1.....</b>	<b>42</b>
6.1	Use of the Soft switching function.....	42
6.1.1	General.....	42
6.1.2	ON soft for stair lighting.....	42
6.1.3	Entrance lighting.....	43
6.1.4	Daytime process simulation.....	44
6.1.5	Post trigger and early switch off.....	45
6.1.6	OFF soft telegram during a ON soft process.....	46
6.1.7	ON soft telegram during a OFF soft process.....	47
6.2	Use of the forced function.....	48
6.3	Brightness control of the energy-savings lamps (LRE).....	48
6.3.1	General.....	48
6.3.2	Behaviour selection RC or L:.....	49
6.3.3	Adjustable RC energy saving lamps (Trailing edge phase control).....	50
6.3.4	Adjustable L energy saving lamps (leading edge phase control).....	51
6.4	Brightness control of energy saving LED lamps.....	52
6.4.1	General.....	52
6.4.2	Behaviour selection RC or L:.....	52
6.5	4-bit telegram (Brighter/darker).....	53
6.5.1	Relative adjustment 4 bit telegram format DPT 3.007 (dimming control).....	53
6.5.2	Parameter “Switching ON/OFF with a 4-bit dim telegram”.....	53
6.6	Scenes.....	54
6.6.1	Principle.....	54
6.6.2	Recall and/or save scenes:.....	54
6.6.3	Enter scene without telegrams.....	56
6.7	Saving light scenes via a push-button.....	57
6.7.1	Assignment of the group addresses and setting of the object flags.....	57
6.7.2	Description of the operation.....	57
6.8	Conversion of the percentages into hexadecimal and decimal values.....	58

6.9	Flow chart .....	58
<b>7</b>	<b>Annex 3: Technical data and manual command .....</b>	<b>59</b>
7.1	Technical data .....	59
7.2	Manual command and LED on the device .....	60
<b>8</b>	<b>Annex 4: Communication objects .....</b>	<b>61</b>

# 1 Introduction

This manual explains the functions of the “**KNX 2 channel 400W universal dimmer – DIN rail mounting**” GWA9303 device and how they are set and configured with the aid of the ETS configuration software.

## 2 Application

The GWA9303 universal dimmer actuator with 2 electronic outputs switches and adjusts the light intensity of incandescent lamps, halogen lamps (high and low voltage), compact adjustable fluorescent lamps (energy saving lamps) or 230V adjustable LED lamps. Actuator for use in large-scale building projects (buildings with offices, public buildings, hotels, etc.) - to be used in closed, dry places only.

### Characteristics and operation

- Brightness control range 0 - 100%
- For adjusting the brightness of incandescent lamps, halogen lamps (high and low voltage), 230V adjustable LED lamps
- Also suitable for controlling the brightness of adjustable energy saving lamps, thanks to the various adjustment curves
- Indication of the switching status with a LED for each channel
- Manual command on the device (even without BUS voltage)
- Brightness control power: 400W per channel, or 1 x 800W in parallel operation
- Automatic recognition of the load (deactivatable) for RC, L loads.

### The main functions are:

- Brightness control
- Control value limitations
- Soft switchover
- Lock function
- Forced operation
- Reception and memorisation of scenes
- Channel status return (ON/OFF or as a percentage)
- Operating hour counter and service message
- Management during mains or BUS failure, and reset
- Diagnostic messages

## 2.1 Association limits

Maximum number of group addresses:	254
Maximum number of associations:	255

This means that up to 254 group addresses can be defined, and up to 255 associations can be made between communication objects and group addresses.

### 3 “General” menu

The **General** menu contains the parameters that permit enabling the device's manual command using the push-buttons on the device. The following menu appears:

-.-. KNX UNIVERSAL DIMMER 2-CH X 400W - DIN RAIL > General

General

Function of manual push button valid until reset via object

Channel CH1: Function selection Manual operation of channels  locked  enabled

Dimming response

Loss and restoration of power

Channel CH2: Function selection

Dimming response

Loss and restoration of power

Fig. 3.1 – Menu “General”

## 3.1 Parameters

### 3.1.1 Function of manual push button

This defines how long the device must operate in manual mode and how this mode is ended. In manual mode, the channels can only be activated and deactivated using the button keys on the device. The values that can be set are:

- locked
- **valid until reset via object** (default value)
- valid 30 min or to reset via object
- valid 1 hour or to reset via object
- valid 2 hours or to reset via object
- valid 4 hours or to reset via object
- valid 8 hours or to reset via object
- valid 12 hours or to reset via object
- valid 24 hours or to reset via object

With **locked**, the manual function is locked.

With **valid until reset via object**, the manual function is active until bus communication is restored via the object **CH1 + CH2 – Manual** (DPT 1.001) received with value = 0 (Auto).

With **valid X min/hours or to reset via object**, the manual function is active for X time or until bus communication is restored via the object **CH1 + CH2 – Manual** (DPT 1.001) received with value = 0 (Auto).

ATTENTION: During manual operation, the telegrams received via bus are ineffective and the output channels can only be controlled using the push-buttons on the device.

After manual operation has ended (the set time has elapsed or the object **CH1 + Ch2 – Manual** = 0) is received, the bus events already received will not be recovered.

The "manual" status is reset in case of a power failure.

The object **CH1 + CH2 – Manual** (DPT 1.001) switches the device to manual mode and/or sends the status of the manual mode. The coding and the resulting action are provided in the following table:

**Table 3.1**

Telegram	Meaning	Explanation
0	Cars	All channels can be commanded via bus or with button keys.
1	Manually	The channels can only be controlled using the button keys on the device. The bus telegrams are ineffective. Any timing functions in progress (e.g. soft switching) are ended.

### 3.1.2 Manual operation of channels

This makes it possible to enable the manual operation of the output channels using the button keys on the device. The values that can be set are:

- **enabled**            **(default value)**
- locked

**Enabled** indicates that the channels can be switches using the button keys on the device.

With **locked**, the button keys on the device are locked.

## 4 “Channel CH1: Function selection” menu

The **Channel CH1: Function selection** menu contains the parameters that permit enabling the active functions on channel 1. The configuration parameters contained in the **Channel CH1: Function selection** menu are the same as those in the **Channel CH2: Function selection** menu for channel 2, therefore they will be described only once.

The following menu appears:

-.- KNX UNIVERSAL DIMMER 2-CH X 400W - DIN RAIL > Channel CH1: Function selection		
General	Adjust dimming value limits	<input checked="" type="radio"/> no <input type="radio"/> yes..
Channel CH1: Function select...	Adjust soft switching	<input checked="" type="radio"/> no <input type="radio"/> yes..
Dimming response	Adjust lock function	<input checked="" type="radio"/> no <input type="radio"/> yes..
Loss and restoration of power	Activate forced mode	<input checked="" type="radio"/> no <input type="radio"/> yes..
Channel CH2: Function selection	Activate scenes	<input checked="" type="radio"/> no <input type="radio"/> yes..
Dimming response	Participation in central objects	no ▼
Loss and restoration of power	Adjust feedback	<input checked="" type="radio"/> no <input type="radio"/> yes..
	Activate hour meter	<input checked="" type="radio"/> no <input type="radio"/> yes..
	Activate diagnostic messages	<input checked="" type="radio"/> no <input type="radio"/> yes..

Fig. 4.1 – Menu “Channel CH1: Function selection”

### 4.1 Parameters

#### 4.1.1 Adjust dimming value limits

This parameter is used to enable the **Dimming value limits** menu by means of which the maximum adjustment value can be set (see Chap. 4.5). The values that can be set are:

- **no** (default value)
- **yes**

By selecting **No**, the standard values are used, i.e. “**Perform limitation when writing object**” = no, “**limit applies to..**”: switching command, relative dimming, absolute dimming, soft switching = no

By selecting **Yes**, the **Dimming value limits** menu is displayed, with which all parameters for this function can be adjusted individually (see Chap. 4.5).

#### 4.1.2 Adjust soft switching

This parameter is used to enable the **Soft switching** menu by means of which the soft adjustment of the brightness is set for when switching occurs (see Chap. 4.6). The values that can be set are:

- **No** (default value)
- **Yes**



By selecting **No**, the standard values are used, i.e. **Time for soft ON** = 1 min, **Dimming value after soft ON** = 100%, **Time between soft ON and soft OFF** = 5 min, **Time for soft OFF** = 1 min.

By selecting **Yes**, the **Soft switching** menu is displayed, with which all parameters for this function can be configured individually (see Chap. 4.6).

### 4.1.3 Adjust lock function

This parameter is used to enable the **Lock function** menu by means of which the operation of the actuator can be set when receiving a lock command (see Chap. 4.7). The values that can be set are:

- **No** (default value)
- Yes

By selecting **No**, the standard values are used, i.e. **Lock telegram** = lock with ON telegram, **Reaction when setting the lock** = 10 %, **Reaction when unlocking** = update.

By selecting **Yes**, the **Lock function** menu is displayed, with which all parameters for this function can be configured individually (see Chap. 4.7).

### 4.1.4 Activate forced mode

This parameter is used to enable the **Forced mode** menu by means of which the operation of the actuator can be set when receiving a forcing command (see Chap. 4.8). The values that can be set are:

- **No** (default value)
- yes

By selecting **No**, no forcing function is activated.

By selecting **Yes**, the **Forced mode** menu is displayed, with which all parameters for this function can be configured individually (see Chap. 4.8).

### 4.1.5 Activate scenes

This parameter is used to enable the **Scenes** menu by means of which the operation of the actuator can be set when receiving a scene (see Chap. 4.9). The values that can be set are:

- **No** (default value)
- Yes

By selecting **No**, the scene management function is not activated.

By selecting **Yes**, the **Scenes** menu is displayed, with which all parameters for this function can be configured individually (see Chap. 4.9).

### 4.1.6 Participation in central objects

With this parameter, it is possible to enable the action of the centralised objects to simultaneously activate or deactivate the switching functions ON, OFF or ON/OFF on both channels. The values that can be set are:

- **No** (default value)
- yes, in all central objects
- only in central permanent ON
- only in central permanent OFF
- only in central switching
- only in central switching and permanent ON
- only in central switching and permanent OFF
- only in central permanent ON and permanent OFF

By selecting **No**, the centralised objects are not considered.

Selecting **yes, in all central objects** enables the action simultaneously on all channels CH1 and CH2 of the centralised objects **Central permanent ON** (DPT 1.001 Switch), **Central permanent OFF** (DPT 1.001 Switch), **Central switching** (DPT 1.001 Switch).

Selecting **only in central permanent ON** enables the action simultaneously on all channels CH1 and CH2 of only the centralised object **Central permanent ON** (DPT 1.001 Switch).

Selecting **only in central permanent OFF**, enables the action simultaneously on all channels CH1 and CH2 of only the centralised object **Central permanent OFF** (DPT 1.001 Switch).

Selecting **only in central switching**, enables the action simultaneously on all channels CH1 and CH2 of only the centralised object **Central switching** (DPT 1.001 Switch).

Selecting **only in central switching and permanent ON** enables the action simultaneously on all channels CH1 and CH2 of the centralised objects **Central permanent ON** (DPT 1.001 Switch) and **Central switching** (DPT 1.001 Switch).

Selecting **only in central switching and permanent OFF** enables the action simultaneously on all channels CH1 and CH2 of the centralised objects **Central permanent OFF** (DPT 1.001 Switch) and **Central switching** (DPT 1.001 Switch).

Selecting **only in central permanent ON and permanent OFF** enables the action simultaneously on all channels CH1 and CH2 of the centralised objects **Central permanent ON** (DPT 1.001 Switch) and **Central permanent OFF** (DPT 1.001 Switch).

The centralised objects permit the device to actuate ON, OFF or ON/OFF switching based on the settings of this parameter, on both channels at the same time. The coding is as follows:

- **Central permanent ON - Receive** (DPT 1.001 Switch), centralised switching object to ON for all channels at the same time. The possible values are:

- 0 = no operation
- 1 = permanently ON

IMPORTANT: the maximum priority can be assigned to this object. As long as it is set, other switching commands to participating channels are inactive.

- **Central permanent OFF - Receive** (DPT 1.001 Switch), centralised switching object to OFF for all channels at the same time. The possible values are:

- 0 = no operation
- 1 = permanently OFF

IMPORTANT: the second level of priority after **Central permanent ON** is assigned to this object. As long as it is set, other switching commands to participating channels are inactive.

- **Central switching** (DPT 1.001 Switch), centralised ON/OFF switching object for all channels at the same time. The possible values are:
  - 0 = OFF
  - 1 = ON

With this object, each participating channel behaves exactly as if the object **Channel CH1 – Switching ON/OFF** (DPT 1.001 Switch) and **Channel CH2 – Switching ON/OFF** (DPT 1.001 Switch) had received a switching command.

#### 4.1.7 Adjust feedback

This parameter is used to enable the **Feedback** menu by means of which the operation of the actuator can be set in relation to sending status feedback (see Chap. 4.10). The values that can be set are:

- **No** (default value)
- yes

By selecting **No**, the default values are used, i.e. **Format of 1-bit feedback** = not inverted, **Send 1-bit feedback cyclically** = no, **Send 8-bit feedback** = only after ending dimming process, **Send 8-bit feedback cyclically** = no, Time for cyclical transmission of feedback (if available) = 60 min.

By selecting **yes**, the **Feedback** menu is displayed, with which all parameters for this function can be configured individually (see Chap. 4.10).

#### 4.1.8 Activate hour meter

This parameter is used to enable the **Hour meter and service** menu by means of which the methods for signalling the device operating hours can be set (see Chap. 4.11). The values that can be set are:

- **No** (default value)
- Yes

By selecting **No**, no contactor is managed.

By selecting **yes**, the **Hour meter and service** menu is displayed, with which all parameters for this function can be configured individually (see Chap. 4.11).

#### 4.1.9 Activate diagnostic messages

This parameter is used to enable the **Diagnostic messages** menu by means of which the methods for signalling the device operating hours can be set (see Chap. 4.12). The values that can be set are:

- **No** (default value)
- Yes

By selecting **No**, no diagnostic message is sent.

By selecting **Yes**, the **Diagnostic messages** menu is displayed, with which all parameters for this function can be configured individually in relation to sending the dedicated objects to the diagnostic messages (see Chap. 4.12).

## 4.2 “Dimming response” parameters menu

The following menu appears:

--- KNX UNIVERSAL DIMMER 2-CH X 400W - DIN RAIL > Dimming response		
General	Load selection	automatic ▼
Channel CH1: Function selection	Minimum dimming value	10 % ▼
<b>Dimming response</b>	Dimming time 1 from 0% to 100%	4 s ▼
	Dimming time 2 from 0% to 100%	8 s ▼
Loss and restoration of power	Dimming time 3 from 0% to 100%	12 s ▼
Channel CH2: Function selection	When receiving a switching order (1 bit)	soft on with dimming time 1 ▼
Dimming response	When receiving a dimming order (4 bit)	soft on with dimming time 1 ▼
Loss and restoration of power	When receiving an absolute value (8 bit)	soft on with dimming time 1 ▼
	Switch-on value	brightness value before previous switch-OFF ▼
	Switching ON/OFF with a 4-bit dim telegram	<input type="radio"/> no <input checked="" type="radio"/> yes

Fig. 4.2 – Menu “Dimming response”

### 4.2.1 Load selection

This parameter sets the type of connected load and as a result the dimmer actuator sets the suitable adjustment. The values that can be set are:

- **automatic** (default value)
- RC load (LED/incand. lamps/electron. transformers)
- L load (wound transformers)
- dimmable energy-savings lamp with RC response
- dimmable energy-savings lamp with L response
- fan (soft switching deactivated)
- LEDs (RC, 0-90 %)
- reserve 2 (don't use !)
- ...
- reserve 32 (don't use !)

With the type of load **automatic**, the dimmer recognises the type of connected load and automatically selects the suitable adjustment strategy (phase control and inversion phase control).

With the type of **RC load (LED/incand.lamps/electron. transformers)**, the actuator controls the adjustment of the phase advance for resistive and capacitive loads (LED lamps, incandescent lamps, high voltage halogen lamps, etc.) and for transformers/electronic power supplies marked for operation on the RC dimmer (trailing edge phase control).

**Note:** When selecting the **RC load** mode, load recognition is carried out as a guarantee. This should prevent the dimmer from being damaged when a load L is connected (e.g. wound transformer). The RC mode is used effectively only if no load L is recognised.

With the type of **L load (wound transformers)**, a leading edge phase control is performed for inductive loads, e.g. wound transformers. It is not suitable for electronic transformers, it can cause a dimmer overload.

With the type of load **dimnable energy-savings lamp with RC response**, the actuator manages a general recommended adjustment for LRE (Energy Savings Lamps) and in particular for high loads (advantage: little heat is developed in the dimmer).

The type of load **dimnable energy-savings lamp with L response**, is used for Energy-Savings Lamps only if the intermittence disturbance occurs brightness increasing or decreasing phase.  
See the appendix: [Brightness control of the energy-savings lamps \(LRE\)](#).

The type of load **fan (soft switching deactivated)**, indicates a special fan mode, with the start time settable via the parameter that is displayed "**Start-up time**".

The type of load **LEDs (RC, 0-90 %)**, is adapted only for LED lights whose brightness does not decrease to 100%.

With the type of load **reserve 2..reserve 32** not used at the moment.

## 4.2.2 Start-up time

If the type of load **fan (soft switching deactivated)**, is selected, this parameter appears that is used to set the time (in seconds) in which the fan must be controlled with complete voltage, until it reaches a certain number of revs.

The values that can be set are:

- 2s, 5s, **10s**, 15s, 20s, 30s, 40s, 50s, 60s (default value)

## 4.2.3 Minimum dimming value

Minimum adjustment value for all the adjustment processes (exception 0%).

Values (switch on adjustment value, behaviour in case of a bus fault etc.) below this threshold is increased to the minimum adjustment value.

The values that can be set are:

- 1 %, 2 %, ..., 9 %, **10 %**, 15 %, 20 %, 25 %, 30 %, 35 %, 40 %, 45 %, 50 % (default value)

## 4.2.4 Dimming time 1, from 0% to 100%

This parameter determines the maximum adjustment speed between 0 to 100%

For more greater flexibility, it is possible to determine 3 different values, adjustment interval 1, 2, 3. The settable values for the adjustment interval 1 are:

- 1 s, 2 s, **4 s**, 6 s, 8 s, 12 s, 15 s, 24 s, 30 s, 60 s (default value)

## 4.2.5 Dimming time 2, from 0% to 100%

This parameter determines the maximum adjustment speed between 0 to 100%

For more greater flexibility, it is possible to determine 3 different values, adjustment interval 1, 2, 3. The settable values for the adjustment interval 2 are:

- 1 s, 2 s, 4 s, 6 s, **8 s**, 12 s, 15 s, 24 s, 30 s, 60 s (default value)

## 4.2.6 Dimming time 3, from 0% to 100%

This parameter determines the maximum adjustment speed between 0 to 100%

For more greater flexibility, it is possible to determine 3 different values, adjustment interval 1, 2, 3. The settable values for the adjustment interval 3 are:

- 1 s, 2 s, 4 s, 6 s, 8 s, **12 s**, 15 s, 24 s, 30 s, 60 s **(default value)**

#### 4.2.7 When receiving a switch order (1 bit)

This parameter determines the adjustment speed from 0% to 100% or from 100% to 0% (if the dimmer receives ON or OFF switch for the lamp all on or all off).

The values that can be set are:

- Immediate on
- **soft on with dimming time 1** **(default value)**
- soft on with dimming time 2
- soft on with dimming time 3

With **immediate on**, the variation from 0% to 100% or from 100% to 0% takes place in max. 1 second.

With **soft on with dimming time 1**, the variation from 0% to 100% or from 100% to 0% takes place within the preset adjustment time via the parameter **Dimming time 1**.

With **soft on with dimming time 2**, the variation from 0% to 100% or from 100% to 0% takes place within the preset adjustment time via the parameter **Dimming time 2**.

With **soft on with dimming time 3**, the variation from 0% to 100% or from 100% to 0% takes place within the preset adjustment time via the parameter **Dimming time 3**.

#### 4.2.8 When receiving a dimming order (4 bit)

This parameter determines the adjustment speed from 0% to 100% or from 100% to 0% (if the dimmer receives ON or OFF switch for the lamp all on or all off).

The values that can be set are:

- Immediate on
- **soft on with dimming time 1** **(default value)**
- soft on with dimming time 2
- soft on with dimming time 3

With **immediate on**, the variation from 0% to 100% or from 100% to 0% takes place within max. 1 second (very fast within intermediate stages), but it can be interrupted by a lock command (release the button key).

With **soft on with dimming time 1**, the variation from 0% to 100% or from 100% to 0% takes place within the preset adjustment time via the parameter **Dimming time 1** in corresponding slower intermediate stages.

With **soft on with dimming time 2**, the variation from 0% to 100% or from 100% to 0% takes place within the preset adjustment time via the parameter **Dimming time 2** in corresponding slower intermediate stages.

With **soft on with dimming time 3**, the variation from 0% to 100% or from 100% to 0% takes place within the preset adjustment time via the parameter **Dimming time 3** in corresponding slower intermediate stages.

## 4.2.9 When receiving an absolute value (8 bit)

This parameter determines the adjustment speed from 0% to 100% or from 100% to 0% (if the dimmer receives ON or OFF switch for the lamp all on or all off).

The values that can be set are:

- Immediate on
- **soft on with dimming time 1** (default value)
- soft on with dimming time 2
- soft on with dimming time 3

With **immediate on**, the adjustment value received is acquired immediately (max. 1 sec. delay).

With **soft on with dimming time 1**, the switch to the new adjustment value takes place within the adjustment time preset via the **Dimming time 1** parameter proportionally to the value change.

With **soft on with dimming time 2**, the switch to the new adjustment value takes place within the adjustment time preset via the **Dimming time 2** parameter proportionally to the value change.

With **soft on with dimming time 3**, the switch to the new adjustment value takes place within the adjustment time preset via the **Dimming time 3** parameter proportionally to the value change.

Example: with **soft on with dimming time 1**, with adjustment value 1 = 12 sec.

The switch from:

- 0 to 100 % or from 100 to 0 % takes place in 12 sec. (= 100 % of 12 sec.)
- 25 to 50 % or 50 to 25 % takes place in 3 sec. (= 25 % of 12 sec.)
- etc.

## 4.2.10 Switch-on value

This is used to set the brightness value that the dimmer must actuate on the switch-on load.

The values that can be set are:

- **Brightness value before previous switch-OFF** (default value)
- Minimum value
- 100 %, 10 %, 20 %, 30 %, 40 %, 50 %, 60%, 70%, 80%, 90%

By selecting **Brightness value before previous switch-OFF**, the device stores the last value that the load had before switch off and resets it at switch on.

By selecting **minimum value**, the minimum configured value is acquired.

Selecting a value between **100%, 10%, ..., 90%**, at switch on the dimmer switches to the selected value. Also here, the minimum configured adjustment value must be considered.

## 4.2.11 Switching ON/OFF with a 4-bit dim telegram

It defines the reaction with the channel off when a 4 bit telegram is received (brighter/darker).

See the appendix: [4 bit telegrams \(darker/brighter\)](#).

The values that can be set are:

- **yes** (default value)
- no

By selecting **yes**, the channel is switched on, adjusted or switched off by the 4 bit object **Channel CH1 – Brighter/darker** (DPT 3.007 dimming control).

By selecting **no**, the channel status is not switched when receiving the 4 bit object **Channel CH1 – Brighter/darker** (DPT 3.007 dimming control).



### 4.3 “Loss and restoration of power parameters menu

The following menu appears:

-.- KNX UNIVERSAL DIMMER 2-CH X 400W - DIN RAIL > Loss and restoration of power		
General	Status at download and bus failure	same as before failure ▼
Channel CH1: Function selection	Status at restoration of mains or bus power	same as before failure ▼
Dimming response		
<a href="#">Loss and restoration of power</a>		

Fig. 4.3 – Menu “Loss and restoration of power”

#### 4.3.1 Status at download and bus failure

With this parameter, it is possible to set a brightness value that the dimmer must actuate after the ETS download or in the case of a bus fault. The values that can be set are:

- **Same as before failure** (default value)
- 100%, 0%, 10%, ....., 90%

If **same as before failure**, is selected, the actuator restores the status prior to the download or maintains the status prior to a bus fault.

If a value between **100%, 0%, 10%..90%** is selected, the set value is implemented. Also in this case, the minimum configured adjustment value is considered.

#### 4.3.2 Status at restoration of mains or bus power

With this parameter, it is possible to set a brightness value that the dimmer must actuate when the power supply returns or after recovering from a bus fault. The values that can be set are:

- **same as before failure** (default value)
- 100%, 0%, 10%, ....., 90%

If **same as before failure** is selected, upon recovery the actuator restores the status prior to the network failure or the bus fault.

If a value between **100%, 0%, 10%..90%** is selected, the set value is implemented when the network returns or the bus failure is restored. Also in this case, the minimum configured adjustment value is considered.

## 4.4 Objects available with parameters default value

When the parameters are set with the default values the following communication objects are already displayed. Other objects remain available in case of a functional enabling respectively on the Channel 1 and Channel 2 via the parameters specified below.

### 4.4.1 Objects for channels 1/2

These objects are dedicated to the operation of each of the two channels CH1 and CH2. **The same objects listed for CH1 are present also for CH2.**

- **Channel CH1 – Switching ON/OFF** (DPT 1.001 Switch), with a 1 on this object, the brightness adjustment is set to 100%, with a 0 it is set to 0%.
- **Channel CH1 – Brighter/darker** (DPT 3.007 dimming control), this object is commanded via the 4 bit telegram (DPT 3.007 control\_dimming). This function makes it possible to gradually adjust the light so it is brighter or darker. As the standard application, telegrams with 64 levels are sent.  
IMPORTANT: the reaction to the 4 bit telegrams depends on the "**Switching ON/OFF with a 4-bit telegram**" parameter. See the appendix: [4 bit telegrams \(brighter/darker\)](#)
- **Channel CH1 – Dimming value** (DPT 5.001 percentage 0..100%), this objects makes it possible to directly select the desired dimmer setting (0 = 0%, 255 = 100%).
- **Channel CH1 – Soft switching** (DPT 1.001 Switch), setting this object to 1 starts the soft switching cycle, meaning that from a minimum brightness level, brightness increases gradually. The adjustment value remains constant during the configured interval and decreases gradually at the end of this interval. When the minimum configured brightness is reached, the adjustment value is reset to 0%. The telegrams can extend the cycle or end it early. This process can be controlled with a timer by setting the "**Time between Soft ON and Soft OFF**" paragraph to "Soft OFF at end of telegram" (see Chap.4.6 **Soft switching**) menu. The adjustment cycle is started with a 1 and ended with a 0. For more information, see the Annex: "[Use of the soft switching function](#)".
- **Channel CH1 – Lock** (DPT 1.001 Switch). The behaviours during setting and cancelling the lock can be configured if the lock function was activated ("**Adjust lock function**" = **yes** parameter in the **Channel CH1: Function selection** menu). The lock occurs only when the object is received, i.e. with lock with telegram OFF, the channel is not locked after the bus returns. If the parameter "**Reaction when setting the lock**" = **no change**, the soft switching process is not interrupted.
- **Channel CH1 – Dimming value limit** (DPT 5.001 percentage 0..100%), the received value is detected as a maximum settable adjustment value. Its validity range is determined on the parameter page **Dimming value limits**.
- **Channel CH1 – Feedback On/Off** (DPT 1.001 Switch), sends the current adjustment status:
  - 1 = the current adjustment value is between 1% and 100%
  - 0 = the current adjustment value is = 0%
- **Channel CH1 – Feedback in %** (DPT 5.001 percentage 0..100%), sends a new adjustment value after a modification, immediately after the end of an adjustment process, or as soon as the new nominal value is reached. Format: 1 byte, 0 ... 255 or 0 ... 100%.

## 4.4.2 Common objects

These objects act on both channels or on the device in general.

- **CH1 + CH2 – Manual** (DPT 1.001 Switch), switches the respective module in manual operation and/or sends the status of the manual operation (see Table 1 below).

**Table 1**

Telegram	Meaning	Explanation
0	Cars	All channels can be commanded via bus or with button keys.
1	Manually	The channels can only be controlled using the button keys on the device. The bus telegrams are ineffective. Any timing functions in progress (e.g. soft switching) are ended.

The duration of manual operation, that is the “**Function of manual push button**”, can be configured in the **General**. menu

After cancelling manual operation, the bus events that were already received are not recovered.

The "manual" status is reset in case of a power failure.

- **Central permanent ON** (DPT 1.001 Switch), centralised switching object to ON of all channels at the same time. The possible values are:

- 0 = no operation
- 1 = permanently ON

IMPORTANT: the maximum priority can be assigned to this object. As long as it is set, other switching commands to participating channels are inactive.

- **Central permanent OFF** (DPT 1.001 Switch), centralised OFF switching object for all channels at the same time. The possible values are:

- 0 = no operation
- 1 = permanently OFF

IMPORTANT: the second level of priority after **Central permanent ON** is assigned to this object. As long as it is set, other switching commands to participating channels are inactive.

- **Central switching** (DPT 1.001 Switch), centralised ON/OFF switching object for all channels at the same time. The possible values are:

- 0 = OFF
- 1 = ON

With this object, each participating channel behaves exactly as if the l'oggetto **Channel CH1 – Switching ON/OFF** (DPT 1.001 Switch) and **Channel CH2 – Switching ON/OFF** (DPT 1.001 Switch) had received a switching command.

- **Central recall/save scenes** (DPT 18.001 Scene). This object is used to save the "scenes" and recall them later.

During the procedure, the current status of the adjustment channel is saved (with other switching status actuators); it does not matter how this status was produced (via the adjustment values, switching commands, centralised objects or manual interruptions).

When this status is recalled, the previously saved status is restored.

Each channel can participate in max. 8 scenes. For scene configuration, see Chap.4.9 **Scene**.

- **BCU version** (DPT 16.001 Character string – ISO 8859-1). Object sent for diagnostic purposes. Sends the software version of the bus coupler after the reset and/or download. It can also be read directly with ETS or by a supervisor.

Format: Axx Hyy Vzzz

Code Meaning

xx 00 .. FF = application version without diaeresis (14 = V1.4, 16 = V1.6 etc.).

yy Hardware version 00..99

zzz Firmware version 000..999

EXAMPLE: A15 H03 V014

- ETS application version 1.5

- Hardware version \$03

- Firmware version \$14

- **Version CH1 + CH2** (DPT 16.001 Character string – ISO 8859-1). Only for diagnostic purposes. Sends the software (firmware) version of the device after the reset and/or download. It can also be read directly with ETS or by a supervisor.

The version is indicated as a sequence of ASCII characters.

**Format: Mxx Hyy Vzzz**

Code	Meaning
xx	01 .. FF = module marking (hexadecimal).
yy	Hardware version 00..99
zzz	Firmware version 000..999

EXAMPLE: **M13 H25 V027**

- Module \$13 = GWA9303

- Hardware version V25

- Firmware version V27

## 4.5 “Dimming value limits” menu parameters

If in the **Channel CH1: Function selection** menu the “**Adjust dimming value limits**” parameter is set to **yes**, the **Dimming value limits** menu appears.

The adjustment value can be temporarily limited with the object **Channel CH1 – Dimming value limit** (DPT 5.001 percentage 0..100%),. The application is used, for example, to ensure that a base lighting level is not exceeded during the night, whereas during the evening, that use is made of the entire lighting range. The function is implemented as follows:

- If the value of the object = 0, then the adjustment value is not limited.
- If the value of the object is greater than 0, then this value indicates the limit of the adjustment value.
- If the value of the object is less than the minimum parametrised adjustment value, the brightness is limited to this minimum adjustment value.
- If the limitation is cancelled, the adjustment value remains limited until a new adjustment command is received.
- The soft ON and soft OFF times are adapted during the limitation so that the speed of the brightness variation remains the same as without limitation.

The parameter menu that appears is as follows:

-.- KNX UNIVERSAL DIMMER 2-CH X 400W - DIN RAIL > Dimming value limits		
General	Perform limitation when writing object	<input checked="" type="radio"/> no <input type="radio"/> yes
Channel CH1: Function selection	Limit applies to switching command (1-bit)	<input checked="" type="radio"/> no <input type="radio"/> yes
Dimming response	Limit applies to relative dimming (4-bit)	<input checked="" type="radio"/> no <input type="radio"/> yes
<b>Dimming value limits</b>	Limit applies to absolute dimming (8-bit)	<input checked="" type="radio"/> no <input type="radio"/> yes
Loss and restoration of power	Limit applies to soft switching	<input checked="" type="radio"/> no <input type="radio"/> yes
Channel CH2: Function selection		

Fig. 4.5 – Menu “Dimming value limits”

### 4.5.1 Perform limitation when writing object

With this parameter, it is possible to limit the adjustment value as soon as a value is received on the object **Channel CH1 – Dimming value limit** (DPT 5.001 percentage 0..100%). The values that can be set are:

- **no** (default value)
- **yes**

By selecting **no**, the limitation effects only the subsequent adjustment process.

By selecting **yes**, the adjustment value is limited as soon as a value is received on the object **Channel CH1 – Dimming value limit** (DPT 5.001 percentage 0..100%).

### 4.5.2 Limit applies to switching command (1 bit)

With this parameter, it is possible to limit the adjustment value or not as soon as a value is received on the 1 bit object **Channel CH1 – Switching ON/OFF** (DPT 1.001 Switch). The values that can be set are:

- **no** (default value)
- yes

By selecting **no**, limitation has no effect in the case of switching commands.

By selecting **yes**, the limitation is enabled if receiving switching commands.

### 4.5.3 Limit applies to relative dimming (4 bit)

With this parameter, it is possible to limit the adjustment value or not as soon as a value is received on the 4 bit object **Channel CH1 – Brighter/darker** (DPT 3.007 dimming control). The values that can be set are:

- **no** (default value)
- yes

By selecting **no**, limitation has no effect in the case of adjustment commands with the 4 bit object.

By selecting **yes**, the limitation is enabled when receiving the adjustment commands with the 4 bit object.

### 4.5.4 Limit applies to absolute dimming (8 bit)

With this parameter, it is possible to limit the adjustment value or not as soon as a value is received on the 8 bit object **Channel CH1 – Dimming value** (DPT 5.001 percentage 0..100%). The values that can be set are:

- **no** (default value)
- yes

By selecting **no**, limitation has no effect in the case of absolute adjustment commands (% value).

By selecting **yes**, the limitation is enabled if receiving the absolute adjustment commands (% value).

### 4.5.5 Limit applies to soft switching

With this parameter, it is possible to limit the adjustment value or not as soon as a value is received on the 1 bit object **Channel CH1 – Soft switching** (DPT 1.001 Switch). The values that can be set are:

- **no** (default value)
- yes

By selecting **no**, limitation has no effect in the case of soft switching commands.

By selecting **yes** the limitation is enabled if receiving soft switching commands.

## 4.6 “Soft switching parameters menu”

If in the **Channel CH1: Function selection** menu the “**Adjust soft switching**” parameter is set to **yes**, the **Soft switching**. menu appears. For more information about soft switching, refer to the Annex “[Use of the soft switching function](#)”.

The parameter menu that appears is as follows:

--.- KNX UNIVERSAL DIMMER 2-CH X 400W - DIN RAIL > Soft switching		
General	Time for Soft ON	1 min
Channel CH1: Function selection	Dimming value after Soft ON	100 %
Dimming response	Time between Soft ON and Soft OFF	5 min
<b>Soft switching</b>	Time for Soft OFF	1 min

Fig. 4.6 – Menu “Soft switching”

### 4.6.1 Time for Soft ON

With this parameter, it is possible to set the duration of the brightness increasing phase (t1) with **Soft switching** (refer to the Annex “[Use of the soft switching function](#)”). 0 sec. = immediate switch on.

IMPORTANT: For additional information, refer to the Annex: [Post trigger and early switch off](#).

The values that can be set are:

- 0 s, 1 s, 2 s, 4 s, 6 s, 8 s, 12 s, 15 s, 24 s, 30 s, 45 s, **1 min**, 2 min, 3 min, 4 min, 5 min, 6 min, 7 min, 8 min, 9 min, 10 min, 12 min, 15 min, 20 min, 30 min, 40 min, 50 min, 60 min **(default value)**

### 4.6.2 Dimming value after Soft ON

This parameter makes it possible to set the final value at the end of the soft ON phase (val).

NB: Also here, the minimum configured adjustment value must be considered.

The values that can be set are:

- 10 %, 20 %, 30 %, 40 %, 50 %, 60 %, 70 %, 80 %, 90 %, **100 %** **(default value)**

### 4.6.3 Time between Soft ON and Soft OFF

This parameter makes it possible to set the time that must elapse between a soft ON and a soft OFF.

The values that can be set are:

- until soft OFF telegram
- 1 s, 2 s, 3 s, 4 s, 5 s, 6 s, 7 s, 8 s, 9 s, 10 s, 15 s, 20 s, 30 s, 40 s, 50 s, 1 min, 2 min, 3 min, 4 min, **5 min**, 6 min, 7 min, 8 min, 9 min, 10 min, 12 min, 15 min, 20 min, 30 min, 40 min, 50 min, 60 min **(default value)**

With **until soft OFF telegram**, there is no time limit, the soft OFF phase is started by means of a telegram.

With a value between **1s, ...60 min**, a delay (t2) is set at the start of the soft OFF phase.

#### 4.6.4 Time for Soft OFF

With this parameter, it is possible to set the duration of the soft OFF phase (t3). 0 sec. = immediate off.

IMPORTANT: For additional information, refer to the Annex: [Post trigger and early switch off](#).

The values that can be set are:

- 0 s, 1 s, 2 s, 4 s, 6 s, 8 s, 12 s, 15 s, 24 s, 30 s, 45 s, **1 min**, 2 min, 3 min, 4 min, 5 min, 6 min, 7 min, 8 min, 9 min, 10 min, 12 min, 15 min, 20 min, 30 min, 40 min, 50 min, 60 min **(default value)**



## 4.7 “Lock function parameters menu”

If in the **Channel CH1: Function selection** menu the “Adjust lock function” parameter is set to **yes**, the **Lock function** menu appears.

The parameter menu that appears is as follows:

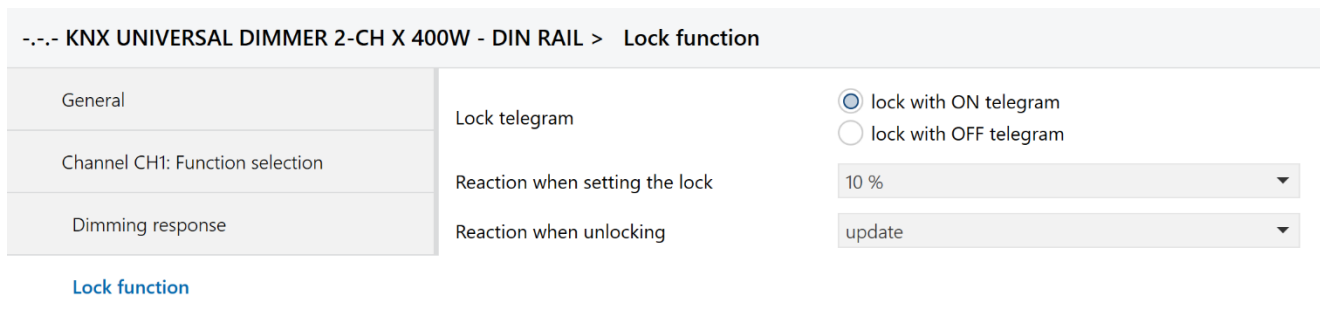

Fig. 4.7 – Menu “Lock function”

### 4.7.1 Lock telegram

With this parameter, it is possible to set the activation of deactivation of the lock when receiving the object **Channel CH1 – Lock** (DPT 1.001 Switch). The possible values are:

- **Lock with ON telegram** **(default value)**
- Lock with OFF telegram

If **Lock with ON telegram**, is selected, the value 1 received with this object activates the lock, value 0 cancels the lock.

If **Lock with OFF telegram**, is selected, the value 0 received with this object activates the lock, value 1 cancels the lock.

Attention: after the reset, the lock is always deactivated.

### 4.7.2 Reaction when setting the lock

With this parameter, it is possible to set the behaviour of the dimmer when activating the lock. The possible values are:

- no change
- 100 %, 0 %, **10 %**, 20 %, 30 %, 40 %, 50 %, 60 %, 70 %, 80 %, 90 % **(default value)**

### 4.7.3 Reaction when unlocking

With this parameter, it is possible to set the behaviour of the dimmer when cancelling the lock. The possible values are:

- no change
- **update** **(default value)**
- 100 %, 0 %, 10 %, 20 %, 30 %, 40 %, 50 %, 60 %, 70 %, 80 %, 90 %

By selecting **no change** there is no reaction.

By selecting **update**, if a telegram is received during the lock, it acquires the status, otherwise it resets the status prior to the lock.

By selecting **100%,..., 90%**, the dimmer adjusts to the set value.

## 4.8 ““Forced mode parameters menu

If in the **Channel CH1: Function selection** menu the “**Activate forced mode**” parameter is set to **yes**, the **Forced mode.** menu appears. The menu that appears changes dynamically based on the “**Format of forced object**” parameter.

### 4.8.1 Format of forced object

With this parameter, it is possible to set the format of the forcing object **Channel CH1 – Force**. Depending on the selection of the type of object **Channel CH1 – Force** parameters appear that make it possible to configure dimmer operation in the forcing status and when it is removed.

The possible values are:

- 1 Bit
- 2 Bit
- 1 Byte (%)

By selecting **1 Bit**, the object **Channel CH1 – Force = 1** is a 1 Bit type (DPT 1.001 Switch) and forcing is activated by switching it to 1=ON (or based on the selection of the “**Activate forced mode with**” parameter).

By selecting **2 Bit**, the object **Channel CH1 – Forced mode** is a 2 Bit type (DPT 2.001 Switch control) and forcing is activated according to the coding of this “priority” or “forcing” object.

By selecting **1 Byte**, the object **Channel CH1 – Dimming value with forced op** is a 1 Byte type (DPT 5.001 valore percentage %) and the dimmer forces the channel CH1 to the % value received with this object.

### 4.8.2 Parameters with Format of forced object” = 1 Bit

The following menu appears:

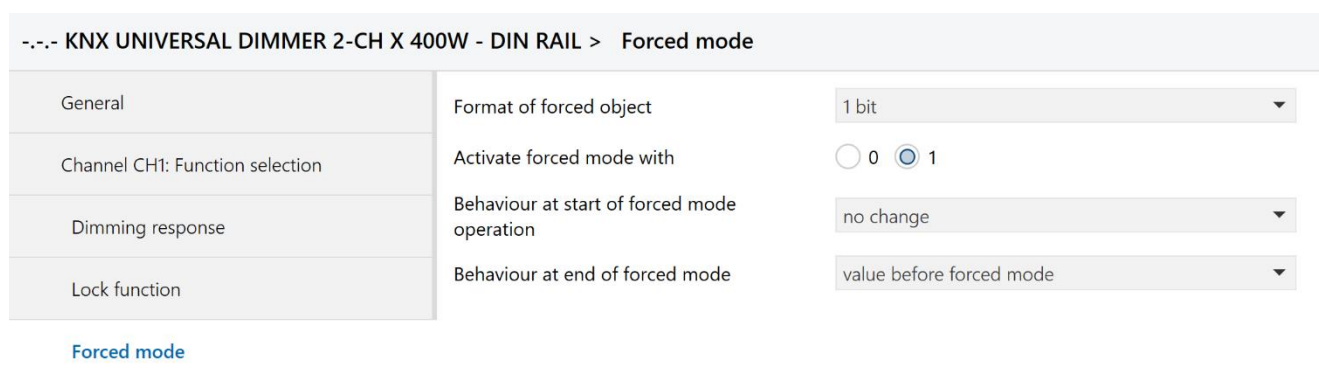

-.- KNX UNIVERSAL DIMMER 2-CH X 400W - DIN RAIL > Forced mode		
General	Format of forced object	1 bit
Channel CH1: Function selection	Activate forced mode with	<input type="radio"/> 0 <input checked="" type="radio"/> 1
Dimming response	Behaviour at start of forced mode operation	no change
Lock function	Behaviour at end of forced mode	value before forced mode

Forced mode

Fig. 4.8.1 – Menu “Forced mode” with “Format of forced object” = 1 Bit”

The following parameters appear.

#### 4.8.2.1 Activate forced mode with

With this parameter it is possible to decide if forcing must be activated when receiving value 1 or 0. If **1** is selected (recommended, **default value**), forcing is activated when receiving the value 1 (ON) on the object **Channel CH1 – Force** is the 1 Bit type (DPT 1.001 Switch).

If **0** is selected, after the reset/download, the forcing status is already activated and must be deactivated if necessary.

#### 4.8.2.2 Behaviour at start of forced mode operation

This parameter is used to decide how the dimmer reacts when receiving a forced start. The possible values are:

- **No change** (default value)
- Minimum value
- 100 %, OFF, 10 %, 20 %, 30 %, 40 %, 50 %, 60 %, 70 %, 80 %, 90 %

By selecting **no change** there is no reaction.

By selecting **minimum value**, forcing leads to the minimum configured adjustment value.

By selecting **100%, OFF, ..., 90%**, the dimmer adjusts to the set value.

#### 4.8.2.3 Behaviour at end of forced mode

This parameter is used to decide how the dimmer reacts when receiving a forced end. The possible values are:

- update
- **value before forced mode** (default value)
- minimum value
- 100 %, OFF, 10 %, 20 %, 30 %, 40 %, 50 %, 60 %, 70 %, 80 %, 90 %

By selecting **update**, if the dimmer receives an ON/OFF command or a % value during forcing, at the end the command or the value is actuated on the output (with the exception of a 4 bit adjustment command that is not saved).

By selecting **value before forced mode**, at the end of forcing, the dimmer actuates the brightness value prior to the forcing on its outputs (in that case, the current commands or the values received during forcing are not saved).

By selecting **minimum value**, the minimum configured adjustment value is considered.

By selecting **100%, OFF, ..., 90%**, the dimmer adjusts to the set value at the end of forcing.

### 4.8.3 Parameters with “Format of forced object” = 2 Bit

The following menu appears:

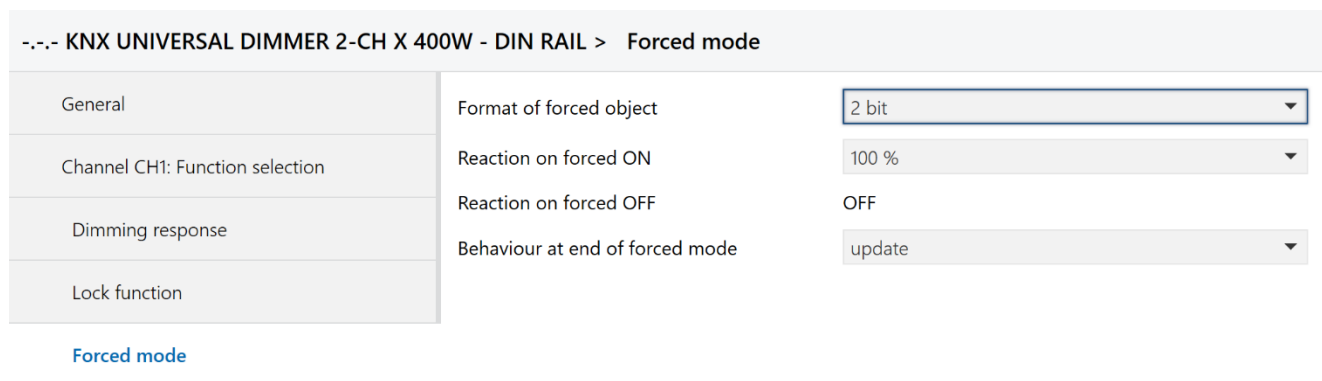

--- KNX UNIVERSAL DIMMER 2-CH X 400W - DIN RAIL > Forced mode		
General	Format of forced object	2 bit
Channel CH1: Function selection	Reaction on forced ON	100 %
Dimming response	Reaction on forced OFF	OFF
Lock function	Behaviour at end of forced mode	update

[Forced mode](#)

Fig. 4.8.2 – Menu “Forced mode” with “Format of forced object” = 2 Bit”

The following parameters appear.

#### 4.8.3.1 Reaction on forced ON

This parameter is used to decide how the dimmer reacts when receiving forcing to ON.

The possible values are:

- **No change** (default value)
- Minimum value
- 100 %, OFF, 10 %, 20 %, 30 %, 40 %, 50 %, 60 %, 70 %, 80 %, 90 %

By selecting **no change** there is no reaction.

By selecting **minimum value**, when receiving a forcing to ON, the dimmer switches to the minimum configured adjustment value.

By selecting **100%, OFF, ..., 90%**, the dimmer adjusts to the set value.

#### 4.8.3.2 Reaction on forced OFF

This parameter determines that if receiving a forcing to OFF, the dimmer is forced **OFF**.

#### 4.8.3.3 Behaviour at end of forced mode

This parameter is used to decide how the dimmer reacts at the end of forcing.

The possible values are:

- **update** (default value)
- value before forced mode
- minimum value
- 100 %, OFF, 10 %, 20 %, 30 %, 40 %, 50 %, 60 %, 70 %, 80 %, 90 %

By selecting **update**, if the dimmer receives an ON/OFF command or a % value during forcing, at the end the command or the value is actuated on the output (with the exception of a 4 bit adjustment command that is not saved).

By selecting **value before forced mode**, at the end of forcing, the dimmer actuates the brightness value prior to the forcing on its outputs (in that case, the current commands or the values received during forcing are not saved).

By selecting **minimum value**, the minimum configured adjustment value is considered.

By selecting **100%, OFF, ..., 90%**, the dimmer adjusts to the set value at the end of forcing.

## 4.8.4 Parameters with Format of forced object” = 1 Byte (%)

The following menu appears:

-.-.- KNX UNIVERSAL DIMMER 2-CH X 400W - DIN RAIL > Forced mode	
General	Format of forced object: 1 byte (%)
Channel CH1: Function selection	Behaviour at end of forced mode: value before forced mode
Dimming response	
Lock function	
<b>Forced mode</b>	

Fig. 4.8.3 – Menu “Forced mode” with “Format of forced object” = 1 byte (%)”

If “**Format of forced object**” has 1 **Byte**, forcing is activated when receiving the object **Channel CH1 – Dimming value with forced op** (DPT 5.001 percentage %) and the value is forced on the channel is the % value coded in the same object (Example, brightness at 80%).

The end of forcing takes place when receiving the same object with a value = 0% (0).

The following parameters appear in the menu.

### 4.8.4.1 Behaviour at end of forced mode

This parameter is used to decide how the dimmer reacts when receiving a forced end, corresponding to receiving the object **Channel CH1 - Dimming value with forced op** (DPT 5.001 percentage %) with value = 0%.

The possible values are:

- **update** (default value)
- value before forced mode
- minimum value
- 100 %, OFF, 10 %, 20 %, 30 %, 40 %, 50 %, 60 %, 70 %, 80 %, 90 %

By selecting **update**, if the dimmer receives an ON/OFF command or a % value during forcing, at the end the command or the value is actuated on the output (with the exception of a 4 bit adjustment command that is not saved).

By selecting **value before forced mode**, at the end of forcing, the dimmer actuates the brightness value prior to the forcing on its outputs (in that case, the current commands or the values received during forcing are not saved).

By selecting **minimum, value**, the minimum configured adjustment value is considered.

By selecting **100%, OFF, ..., 90%**, the dimmer adjusts to the set value at the end of forcing.

## 4.9 “Scenes parameters menu

If in the **Channel CH1: Function selection** menu the “**Activate scenes**” parameter is set to **yes**, the **Scenes** menu appears. Each channel can manage a maximum of 8 scenes.

The following menu appears:

--- KNX UNIVERSAL DIMMER 2-CH X 400W - DIN RAIL > Scenes

General	Lock telegram for scenes	<input checked="" type="radio"/> lock with ON telegram <input type="radio"/> lock with OFF telegram
Channel CH1: Function selection	All scene statuses of channel	<input checked="" type="radio"/> overwrite when downloading <input type="radio"/> unchanged after download
Dimming response	Participation in object Central scene	<input checked="" type="radio"/> no <input type="radio"/> yes
<b>Scenes</b>		
Loss and restoration of power	Channel reacts to	scene number 1 ▼
Channel CH2: Function selection	Allocated dimming value	10 % ▼
Dimming response	Response when receiving scene numbers	soft on with dimming time 1 ▼
Loss and restoration of power	Permit teach-in	<input type="radio"/> no <input checked="" type="radio"/> yes
	Channel reacts to	scene number 2 ▼
	Allocated dimming value	20 % ▼
	Response when receiving scene numbers	soft on with dimming time 1 ▼
	Permit teach-in	<input type="radio"/> no <input checked="" type="radio"/> yes

Fig. 4.9 – Menu “Scenes”

### 4.9.1 Lock telegram for scenes

With this parameter, it is possible to set the value to be adopted by the object **Channel CH1 – Lock scenes** (DPT 1.001 Switch) assigned to lock the scenes function. It is not possible to recall or save scenes as long as the scenes function remains locked. The values that can be set are:

- **Lock with ON telegram** (default value)
- Lock with OFF telegram

If **lock with ON telegram** is selected, the scenes are locked when receiving the object **Channel CH1 – Lock scenes** (DPT 1.001 Switch) = 1 (ON), and the lock is cancelled when a 0 (OFF) is received.

If selecting **lock with OFF telegram**, the scenes are locked when receiving the object **Channel CH1 – Lock scenes** (DPT 1.001 Switch) = 0 (OFF), and enabled when receiving the object **Channel CH1 – Lock scenes** (DPT 1.001 Switch) = 1 (ON),

## 4.9.2 All scene statuses of channel

This parameter is used to decide if, when the application is downloaded from ETS, the saved scenes should be deleted or remain unchanged. The values that can be set are:

- **overwrite when downloading** (default value)
- unchanged after download

If **overwrite when downloading** is selected, the device deletes all the memories for the channel scenes, meaning all the scenes taught up to that moment. When a scene number is recalled, the channel acquires the value configured with the parameter “**Allocated dimming value**” (see below).

See the appendix: [Enter scene without telegrams](#).

If **unchanged after download**, is selected, all the scenes remain unchanged. The number of scenes to which the channel must react can be changed however (see the following parameter “**Channel reacts to**”).

## 4.9.3 Participation in object Central scene

This parameter is used to if the device must react or not to the object **Central recall/save scenes** (DPT 18.001 Scene).

- **no** (default value)
- yes

## 4.9.4 Channel reacts to

This parameter is used to specify the number of the scene, from 1 to 63, to which the device must react. A scene is activated on the relative channel when receiving the object **Channel CH1 – Call up/save scenes** (DPT 18.001 Scene). This object is used to save the scenes and recall them later. The adjustment value of the channel brightness is saved. It does not matter how this brightness adjustment value was produced (via switching commands, centralised objects or button keys on the equipment).

When recalled, the stored brightness adjustment value is restored. For more information about the management of the scenes, refer to the following chapter in the Annex: [The scenes](#).

The possible values are:

- No scene number
- **Scene number 1** (default value)
- ..
- Scene number 63

With **scene number X** the scene number **X** attributed to the first scene possible to which the channel must react is entered.

## 4.9.5 Allocated dimming value

This parameter adjust the adjustment value associated with the scene number selected with the previous parameter. The possible values are:

- Off, **10 %**, 20 %, 30 %, 40 %, 50 %, 60 %, 70 %, 80 %, 90 %, 100 % (default value)

Using this parameter to set the percentage brightness value to be recalled on the dimmer output channel when receiving a scene, this value is written to the memory only if the “**All scene statuses of channel**” parameter is set to “**overwrite when downloading**”.



## 4.9.6 Response when receiving scene numbers

This parameter determines the adjustment speed with which the dimmer reaches the value assigned to scene X in the previous “**Allocated dimming value**” parameter.

The values that can be set are:

- Immediate on
- **soft on with dimming time 1** (default value)
- soft on with dimming time 2
- soft on with dimming time 3

With **immediate on**, the dimmer reaches the assigned value immediately.

With **soft on with dimming time 1**, the variation to reach the assigned value takes place within the adjustment time preset via the **Dimming time 1** parameter.

With **soft on with dimming time 2**, the variation to reach the assigned value takes place within the adjustment time preset via the **Dimming time 2** parameter.

With **soft on with dimming time 3**, the variation to reach the assigned value takes place within the adjustment time preset via the **Dimming time 3** parameter.

## 4.9.7 Permit teach-in

This parameter enables the teaching of a new scene. The possible values are:

- **yes** (default value)
- no

By selecting **yes**, the user can recall, teach/modify the preset scenes.

By selecting **no**, the scenes can only be recalled based on the parametric settings and cannot be changed by the user.

## THE PARAMETERS ARE THE SAME FOR ALL THE OTHER SCENES

The three parameters indicated above are replicated for all 8 possible scenes that can be associated with channel 1 (also for the analogous parameters for channel 2).

The only thing that changes is the default value associated with the “**Allocated dimming value**” parameter for each scene, respectively 10%, 20%, ..., 80%.

## 4.10 “Feedback parameters menu

If in the **Channel CH1: Function selection** menu the “**Adjust feedback**” parameter is set to **yes**, the **Feedback** menu appears.

Each channel has two status objects, an on/off feedback via the object **Channel CH1 – Feedback ON/OFF** (DPT 1.001 Switch) and a feedback with the brightness value percentage, current on the output channel, sent via the object **Channel CH1 – Feedback in %** (DPT 5.001 percentage).

The following parameters are used to set the transmission conditions for the two status objects.

The following menu appears:

Fig. 4.10 – Menu “Feedback”

### 4.10.1 Format of 1-bit feedback

This parameter makes it possible to set the value to be adopted by the 1 bit status object **Channel CH1 – Feedback ON/OFF** (DPT 1.001 Switch) for the ON and OFF feedback. The values that can be set are:

- **Not inverted (default value)**
- inverted

If **not inverted** is selected, the object has the standard coding: **1-100% = 1, 0% = 0**

If **inverted** is selected, the object inverts the standard coding: **1-100% = 0, 0% = 1**

### 4.10.2 Send 1-bit feedback cyclically

This parameter makes it possible to activate the cyclical transmission of the 1 bit status object **Channel CH1 – Feedback ON/OFF** (DPT 1.001 Switch). The cyclical transmission times are specified in the parameter “**Time for cyclical transmission of feedback (if available)**”.

The values that can be set are:

- **No (default value)**
- yes

### 4.10.3 Send 8-bit feedback

This parameter is used to decide when and under what conditions the device transmits the 8 bit status object **Channel CH1 – Feedback in %** (DPT 5.001 percentage).

The values that can be set are:

- **only after ending dimming process** (default value)
- every 10%
- every 20%
- every 30%

If **only after ending dimming process** is selected, the device transmits the current adjustment value only if a new adjustment value was received.

If **every 10%**, **every 20%** or **every 30%**, is selected, the device sends the status as a percentage also during the adjustment process at each brightness variation of 10, 20 or 30%.

### 4.10.4 Send 8-bit feedback cyclically

This parameter makes it possible to activate the cyclical transmission of the 8 bit status object **Channel CH1 – Feedback in %** (DPT 5.001 percentage). The cyclical transmission times are specified in the parameter “**Time for cyclical transmission of feedback (if available)**”.

The values that can be set are:

- **no** (default value)
- yes

### 4.10.5 Time for cyclical transmission of feedback (if available)

This parameter sets the interval for the cyclical transmission of the 8 bit status object **Channel CH1 – Feedback On/Off** (DPT 1.001 Switch) and/or the object **Channel CH1 – Feedback in %** (DPT 5.001 Percentage %) if enabled with the previous parameters.

The values that can be set are:

- 2 min, 3 min , 5 min, 10 min, 15 min, 20 min, 30 min, 45 min, **60 min** (default value)

## 4.11 “Hour meter and service” menu parameters

If in the **Channel CH1: Function selection** menu the “**Activate hour meter**” parameter is set to **yes**, the **Hour meter and service** menu appears.

The following menu appears:

-.- KNX UNIVERSAL DIMMER 2-CH X 400W - DIN RAIL > Hour meter and service	
General	Type of hour meter <input checked="" type="radio"/> operating hours counter <input type="radio"/> counter for time to next service
Channel CH1: Function selection	Report operating hours at change (0..100 h, 0 = no report) <input type="text" value="10"/>
Dimming response	Transmit operating hours cyclically <input type="radio"/> no <input checked="" type="radio"/> yes
Dimming value limits	Time for cyclical transmission <input type="text" value="60 min"/>
<a href="#">Hour meter and service</a>	

Fig. 4.11 – Menu “Hour meter and service”

### 4.11.1 Type of hour meter

This parameter can be used to set feedback with the number of the operating hours of channel (and therefore the connected load) or the time remaining the set service interval elapses, which can be useful for preventive maintenance purposes (changing the lamp when reaching the maximum number of operating hours). The values that can be set are:

- **Operating hours counter (default value)**
- Counter for time to next service

If **operating hours counter** is selected, the object **Channel CH1 – Operating hours feedback** (DPT 7.001 pulses) that signals the operating hours is transmitted under the conditions specified in the following parameters. The operating hour counter is reset with the object **Channel CH1 – Reset operating hours** (DPT 1.001 Switch).

If **counter for time to next service** is selected, the object **Channel CH1 – Time to next service** (DPT 7.001 pulses) signals the time in minutes after which the next service is necessary. The service required message is transmitted via the object **Channel CH1 – Service required** (DPT 1.001 Switch). This object indicates if the set maintenance interval has elapsed (0 = not elapsed; 1 = maintenance interval elapsed).

Via the object **Channel CH1 – Reset service** (DPT 1.001 Switch), the regressive hour counter is reset for the next service.

The following parameters are displayed based on the value selected for this parameter.

### 4.11.2 Report operating hours at change (0..100h, 0 = no report)

If the “**Type of hour meter**” is set to **operating hours counter**, this parameter appears, which is used to specify how often to send the current count level of the hour counter. The values that can be set are:

- **0..100 (default value = 10)**

Example: with **value = 10**, the operating hour counter transmits each time the count is increased 10 hours. By setting a **value = 0**, no report is sent.

### 4.11.3 Transmit operating hours cyclically

If the “**Type of hour meter**” is set to **operating hours counter**, this parameter appears, which is used to specify whether to send the operating hours cyclically.

The values that can be set are:

- **No**
- **yes**

With **yes**, the “**Time for cyclical transmission**” parameter appears, which is used to set the cyclical transmission time of the operating hours via the object **Channel CH1 – Operating hours feedback** (DPT 7.001 pulses). The possible values are:

- 2 minutes, 3 minutes, 5 minutes, 10 minutes, 15 minutes, 20 minutes, 30 minutes, 45 minutes, **60 minutes (default value)**

### 4.11.4 Service interval (0..2000, x 10h)

If the “**Type of hour meter**” is set to **counter for time to next service** this parameter appears, which is used to specify the desired interval that must pass between two service messages. The values that can be set (x 10 hours) are:

- **0..2000 (default value = 100)**

Example: with value 10= 10x10 h = 100 hours

### 4.11.5 Report time to service when changed (0..100h, 0 = no report)

If the “**Type of hour meter**” is set to **counter for time to next service** this parameter appears, which is used to specify in which interval the current count level must be sent. The values that can be set (x 10 hours) are:

- **0..100 (default value = 10)**

Example: with value 10 = transmit each time the count level has decreased another 10 hours.

### 4.11.6 Transmit time to service cyclically

If the “**Type of hour meter**” is set to **counter for time to next service**, this parameter appears, which is used to specify the whether to cyclically transmit the interval of time that remains until the next service, via the object **Channel CH1 – Time to next service** (DPT 7.001 pulses).

The values that can be set are:

- **No**
- **yes**

If **yes** is selected, the “**Time for cyclical transmission**” parameter appears, which can be used to set a cyclical transmission time of the interval that remains until the next service via the object **Channel CH1 – Time to next service** (DPT 7.001 pulses).

#### 4.11.7 Report service cyclically

If “**Type of hour meter**” is set to **counter for time to next service**, this parameter appears, which is used to specify whether to cyclically send the message that the maintenance interval has elapsed via the object **Channel CH1 – Service required** (0 = not elapsed; 1 = maintenance interval elapsed).

The values that can be set are:

- **No**
- **yes**

If **yes** is selected, the “**Time for cyclical transmission**” parameter appears, which is used to set a cyclical transmission time of the end of the maintenance interval.

#### 4.11.8 Time for cyclical transmission (time to service)

If enabled with the previous parameters, the cyclical transmission of the time until the next service or the service required request, this parameter appears that makes it possible to set the cyclical transmission time of the objects **Channel CH1 – Time to next service** (DPT 7.001 pulses) or **Channel CH1 – Service required** (DPT 1.001 Switch).

If both the parameters “**Transmit time to service cyclically**” and “**Report service cyclically**” are both set to **yes**, this parameter adopt the name “**Time for cyclical transmission (time to service)**” and the value entered applies for both cyclical transmissions of the two objects.

The values that can be set are:

- 2 min, 3 min , 5 min, 10 min, 15 min, 20 min, 30 min, 45 min, **60 min (default value)**

## 4.12 “Diagnostic messages parameters menu

If in the **Channel CH1: Function selection** menu the “**Activate diagnostic messages**” parameter is set to **yes**, the **Diagnostic messages.** menu appears. These parameters can be used to transmit the dedicated objects to the diagnostics as specified below.

The following menu appears:

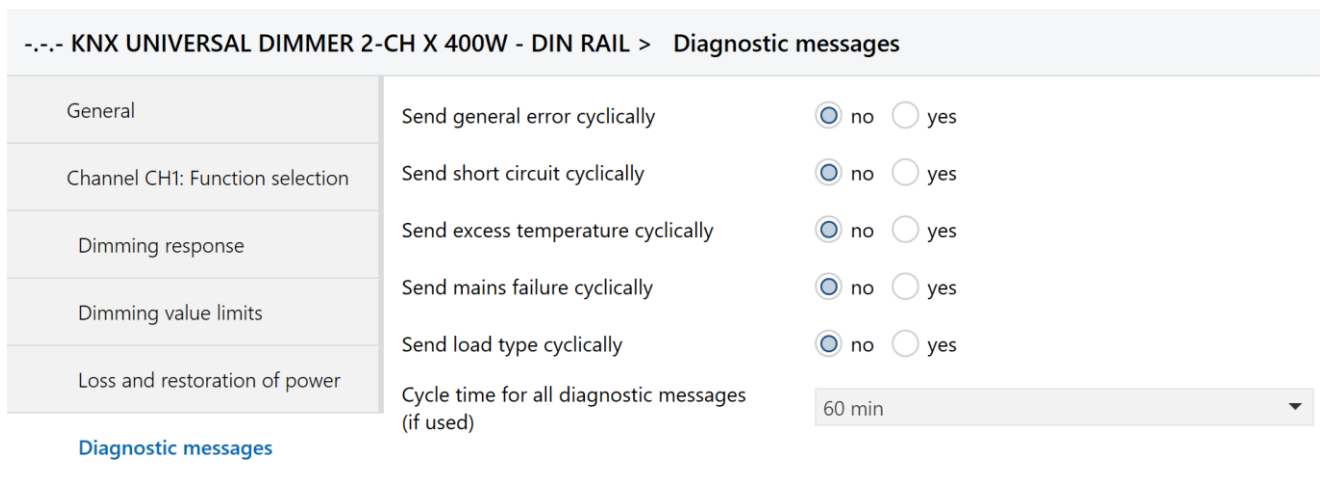

-.- KNX UNIVERSAL DIMMER 2-CH X 400W - DIN RAIL > Diagnostic messages		
General	Send general error cyclically	<input checked="" type="radio"/> no <input type="radio"/> yes
Channel CH1: Function selection	Send short circuit cyclically	<input checked="" type="radio"/> no <input type="radio"/> yes
Dimming response	Send excess temperature cyclically	<input checked="" type="radio"/> no <input type="radio"/> yes
Dimming value limits	Send mains failure cyclically	<input checked="" type="radio"/> no <input type="radio"/> yes
Loss and restoration of power	Send load type cyclically	<input checked="" type="radio"/> no <input type="radio"/> yes
	Cycle time for all diagnostic messages (if used)	60 min ▼

Fig. 4.12 – Menu “Diagnostic messages”

### 4.12.1 Send general error cyclically

With this parameter it is possible to decide whether to cyclically transmit the general error message **Channel CH1 – General error message** (DPT 1.001 Switch) that is used to report a device malfunction (0 = no error; 1 = an error was detected). This message can be sent to a display.

The values that can be set are:

- **no (default value)**
- yes

The cyclical transmission time can be set with the parameter “**Cycle time for all diagnostic messages (if used)**”.

### 4.12.2 Send short circuit cyclically

With this parameter, it is possible to decide whether to cyclically transmit the short circuit message object to the dimmer output **Channel CH1 – Short circuit message** (DPT 1.001 Switch). The 1 bit object can have the values 0 = all OK; 1 = short circuit at the dimmer output (therefore check the lines and the load connected to the outputs). The values that can be set are:

- **no (default value)**
- yes

The cyclical transmission time can be set with the parameter “**Cycle time for all diagnostic messages (if used)**”.

### 4.12.3 Send excess temperature cyclically

With this parameter, it is possible to decide whether to cyclically transmit the excess temperature in the dimmer message object **Channel CH1 – Excess temperature message** (DPT 1.001 Switch). The 1 bit object can have the values 0 = all OK; 1 = the dimmer is overloaded.

The reasons for the dimmer overload that can cause excess temperature can be:

- connected power too high.
- room temperature too high.
- incorrect assembly position, the device cannot discharge the heat.

In case of an overtemperature, status LEDs 2, 3, and 4 flash.

The values that can be set are:

- **no (default value)**
- yes

The cyclical transmission time can be set with the parameter “**Cycle time for all diagnostic messages (if used)**”.

### 4.12.4 Send mains failure cyclically

With this parameter, it is possible to decide whether to cyclically transmit the mains error message, i.e. a mains power failure or hardware error, **Channel CH1 – Mains power failure** (DPT 1.001 Switch). The 1 bit object can have the values 0 = all OK; 1 = mains power failure (no power supply or hardware error).

The values that can be set are:

- **no (default value)**
- yes

The cyclical transmission time can be set with the parameter “**Cycle time for all diagnostic messages (if used)**”.

### 4.12.5 Send load type cyclically

With this parameter, it is possible to decide whether to cyclically transmit the report object with the type of load connected **Channel CH1 – Load type message (RC, L)** (DPT 1.001 Switch). The 1 bit object can have the values 0 = phase check (Load L connected), conventional transformers; 1 = inversion phase control (connected RC load), electronic transformers or incandescent lamps.

The values that can be set are:

- **no (default value)**
- yes

The cyclical transmission time can be set with the parameter “**Cycle time for all diagnostic messages (if used)**”.

### 4.12.6 Cycle time for all diagnostic messages (if used)

This parameter permits setting a cyclical transmission time for all diagnostic messages if enabled. The values that can be set are:

- 2 min, 3 min , 5 min, 10 min, 15 min, 20 min, 30 min, 45 min, **60 min (default value)**



## 5 “Channel CH2: Function selection menu

The **Channel CH2: Function selection** menu contains the parameters that permit enabling the active functions on channel 2. The following menu appears:

-.- KNX UNIVERSAL DIMMER 2-CH X 400W - DIN RAIL > Channel CH2: Function selection		
General	Copy main parameters from channel CH1	no
Channel CH1: Function selection	Adjust dimming value limits	<input checked="" type="radio"/> no <input type="radio"/> yes..
Dimming response	Adjust soft switching	<input checked="" type="radio"/> no <input type="radio"/> yes..
Dimming value limits	Adjust lock function	<input checked="" type="radio"/> no <input type="radio"/> yes..
Loss and restoration of power	Activate forced mode	<input checked="" type="radio"/> no <input type="radio"/> yes..
Diagnostic messages	Activate scenes	<input checked="" type="radio"/> no <input type="radio"/> yes..
	Participation in central objects	no
<b>Channel CH2: Function select...</b>	Adjust feedback	<input checked="" type="radio"/> no <input type="radio"/> yes..
Dimming response	Activate hour meter	<input checked="" type="radio"/> no <input type="radio"/> yes..
Loss and restoration of power	Activate diagnostic messages	<input checked="" type="radio"/> no <input type="radio"/> yes..

Fig. 5.1 – Menu “Channel CH2: Function selection”

### 5.1 Parameters

The configuration parameters in the **Channel CH2: Function selection** menu are the same as those in the **Channel CH1: Function selection**, menu, with the exception of the parameter indicated below, which is present only in the CH2 menu.

- For all the other parameters, refer above to Chap. 4.

#### 5.1.1 Copy main parameters from channel CH1

This parameter facilitates the configuration of the device in order to copy the settings for channel 1 to the parameters of channel 2. The values that can be set are:

- **No** (default value)
- yes
- yes, channel CH2 boosts channel CH1

By selecting **No**, CH1 and CH2 can be configured fully independently of each other.

By selecting **yes**, CH2 is automatically configured with the same settings as CH1.

Only the parameter in the **Forced mode**, **Scenes**, **Hour meter** and **service** and **Diagnostic messages** menus can be configured individually for CH2

By selecting **yes, channel CH2 boosts channel CH1**, channel CH2 is wired in parallel with CH1 and serves only as a power amplifier. In this case, it is possible therefore to connect the two channels in parallel and reach an adjustment power of up to 800 W.

## 6 Annex 1

### 6.1 Use of the *Soft switching* function

#### 6.1.1 General

The soft switching function is a cycle comprised of switch on, increase of brightness, maintenance of the target brightness, decrease of brightness and switch off.

#### 6.1.2 ON soft for stair lighting

The following operation is recommended for stair lighting:

- When pressing the light push-button: maximum brightness.
- After the desired time has elapsed: progressive reduction of the brightness and switch off.

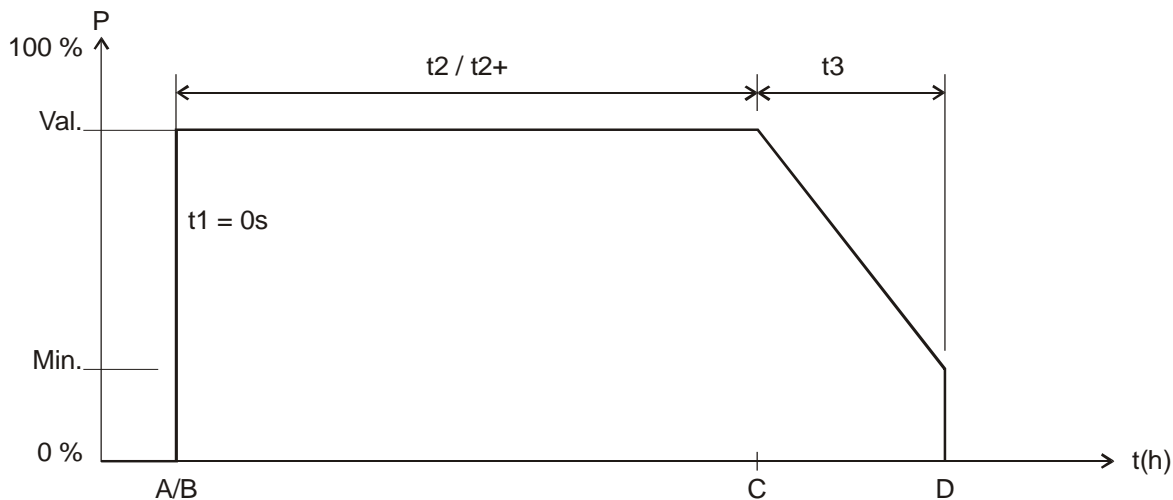

A	The push-button sends a <i>Soft ON</i> telegram.
t1	The <i>soft ON</i> time is equal to 0, that is the "gradual brightness increase" is deactivated
B	Brightness is set immediately to the configured value after <i>soft ON</i>
t2	Time configured between <i>soft ON</i> and <i>soft OFF</i> *
t2+	t2 possibly extended by a new telegram <i>soft ON</i>
C	t2 or t2+ has elapsed or a <i>soft OFF</i> telegram was received: Start of the <i>soft OFF</i> phase
t3	The brightness is reduced gradually within the time configured for <i>soft OFF</i>
I	t3 has elapsed, the <i>Minimum dimming value</i> is reached and reduced to 0%

\* *soft OFF* for the duration configured or *soft OFF* telegram.

The light can be turned off with a *soft OFF* telegram or be activated again with a *soft ON* telegram.

### 6.1.3 Entrance lighting

Application example: a movement detector activates the dimmer via the object **Channel CHx – Soft switching** (DPT 1.001 Switch). If movement is detected, brightness is increased within 5 sec. This delay allows the eyes to adjust to the light without being dazzled. After the configured time or after sending a soft OFF telegram by means of the push-button or the movement detector (cyclic), the light intensity is progressively reduced and turned off within 1 minute.

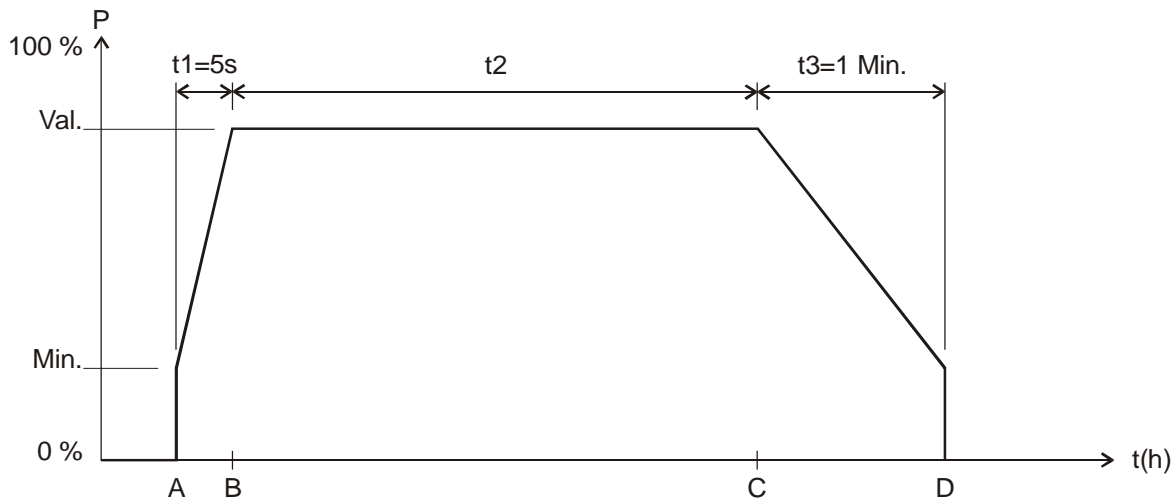

Process:

A	The movement detector sends <i>soft ON</i> : The brightness is set to the configured <i>minimum adjustment value</i>
t1	The brightness is gradually increased within the time configured for <i>soft ON</i> (5 sec.)
B	The configured value is reached after <i>soft ON</i>
t2	Time between <i>soft ON (1)</i> and <i>soft OFF</i>
C	The <i>soft OFF</i> telegram was received or the configured time has elapsed: Start of the <i>soft OFF</i> phase
t3	The brightness is reduced gradually within the time configured for <i>soft OFF</i>
I	t3 has elapsed, the <i>Minimum dimming value</i> is reached and reduced to 0%

## 6.1.4 Daytime process simulation

It is possible to simulate the complete daytime process, with sunlight and sunset, in association with a timer or supervisor. For this purpose, the "Time between Soft ON and Soft OFF" parameter must be set to "until soft OFF telegram".

In the morning, for example, a timer (or a supervisor) sends a soft ON telegram (=1) and, in the evening, a soft OFF telegram (=0) to the object **Channel CHx – Soft switching** (DPT 1.001 Switch).

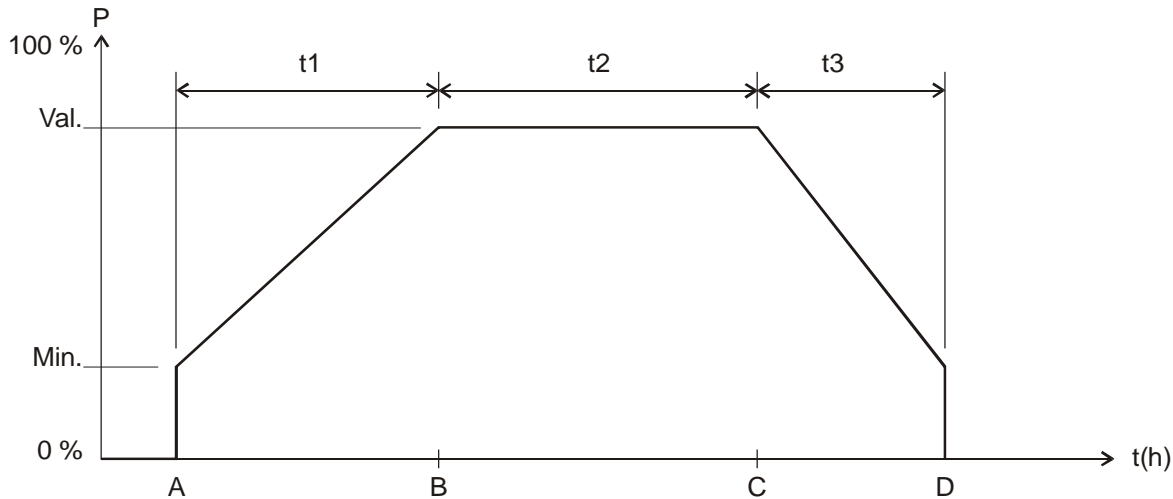

Key:

Minimum	Minimum dimming value configured
Val.	Nominal adjustment value, i.e the configured <i>Dimming value after Soft ON</i>
t(h)	Time

Process:

A	The timer or supervisor sends <i>soft ON</i> : The brightness is set to the configured <i>Minimum dimming value</i>
t1	The brightness is increased gradually within the time configured for <i>soft ON</i>
B	The configured value is reached after <i>soft ON</i>
t2	The time programmed in the timer between the <i>soft ON</i> (1) and <i>soft OFF</i> (0) telegram
C	The <i>soft OFF</i> telegram was received: start of the <i>soft OFF</i> phase
t3	The brightness is reduced gradually within the time configured for <i>soft OFF</i>
I	t3 has elapsed, the <i>Minimum dimming value</i> is reached and reduced to 0%

## 6.1.5 Post trigger and early switch off

It is also possible to influence the soft switching process while it is in progress. By sending the soft ON and soft OFF telegrams, it is possible, according to the current phase in progress, to obtain the following reactions:

**Table 6.1.5**

Telegram	Reaction
Soft ON during t1	none
Soft ON during t2	t2 starts from the beginning
Soft ON during t3	a new soft ON process is started. See below.
Soft OFF during t1	The soft ON process is interrupted and the soft OFF phase starts immediately. See below.
Soft OFF during t2	the soft OFF phase starts immediately
Soft OFF during t3	none

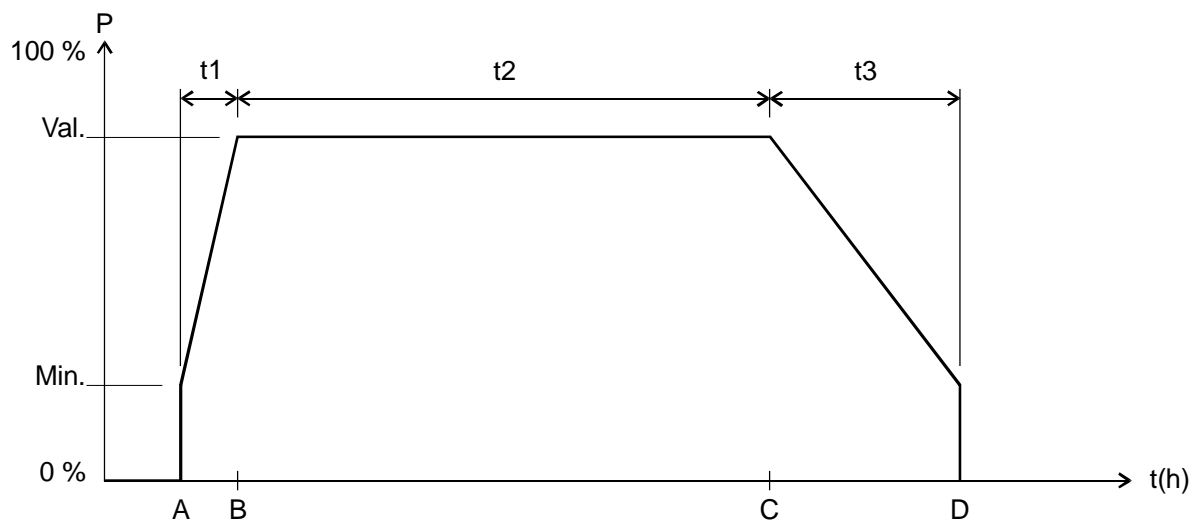

## 6.1.6 OFF soft telegram during a ON soft process

The duration of the soft OFF phase ( $t3'$ ) always corresponds to the configured time, independently of the adjustment value of the moment.

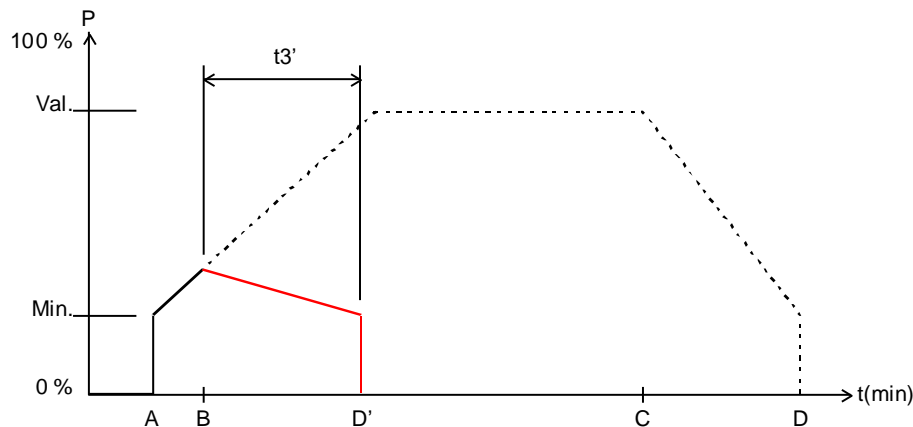

Example 1: soft OFF at the start of the soft ON phase.

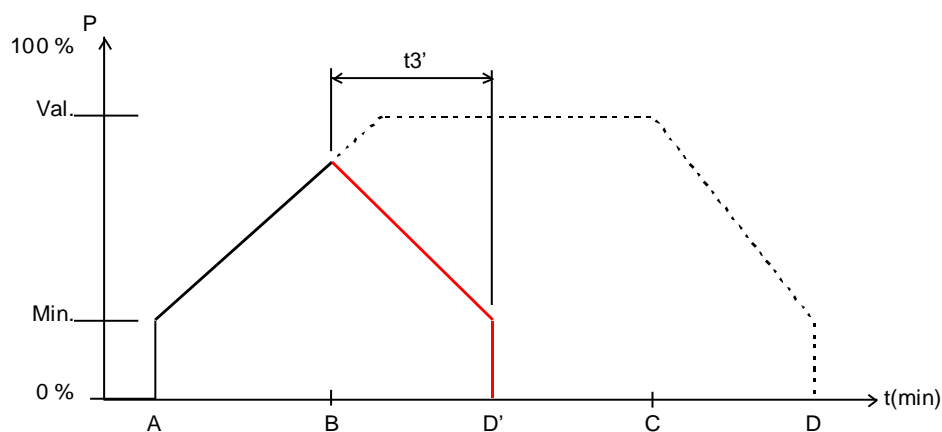

Example 2: soft OFF towards the end of the soft ON phase.

Process:

A	A soft ON process is started
B	A soft OFF telegram is received: the soft ON phase is interrupted and a soft OFF phase starts.
$t3'$	Duration of the soft OFF phase = configured soft OFF time
D'	End of the soft OFF phase

### 6.1.7 ON soft telegram during a OFF soft process

The duration of the soft ON phase ( $t1'$ ) always corresponds to the configured time, independently of the adjustment value of the moment.

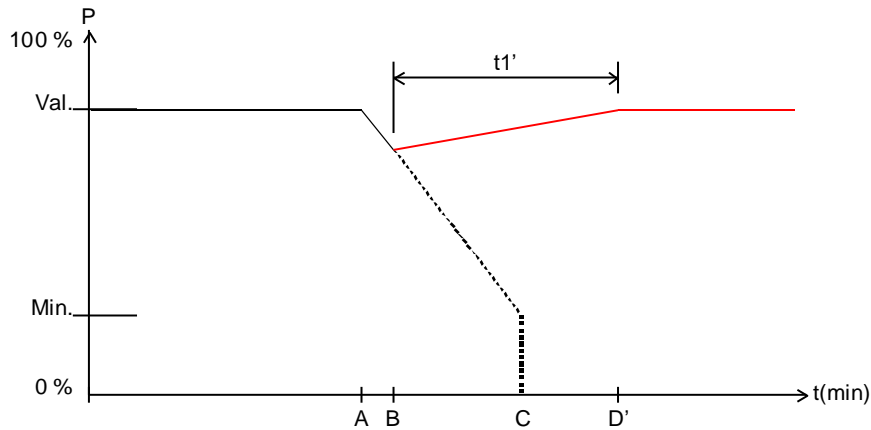

Example 3: soft ON at the start of the soft OFF phase.

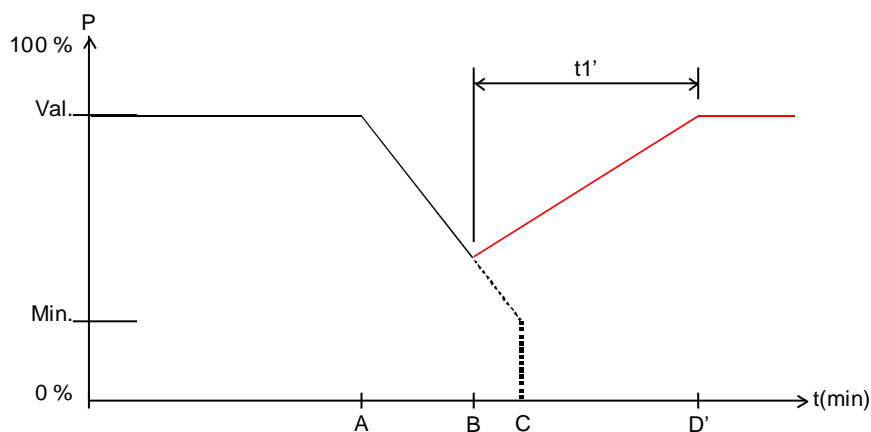

Example 4: soft ON towards the end of the soft OFF phase.

Process:

A	A soft OFF process is started
B	A soft OFF telegram is received: the soft OFF phase is interrupted and a soft ON phase starts.
$t1'$	Duration of the soft ON phase = configured soft ON time
D'	End of the soft ON phase

## 6.2 Use of the forced function

Application example: lighting during the day with brightness adjustment and minimum lighting during the night.

- A brightness regulator continuously measures the brightness of the room and commands the dimmer to maintain constant brightness.
- An adjustment value of 20% is configured for the forced operation.
- During the evening, at the end of work, a timer or supervisor activates the forced operation, which reduces brightness to 20%.
- During the night, surveillance personnel turn on the light for a certain period of time using "Permanently centralised ON".
- In the morning, at the start of work, the timer or supervisor deactivates the forced operation and the dimmer is controlled by means of the brightness adjustment.

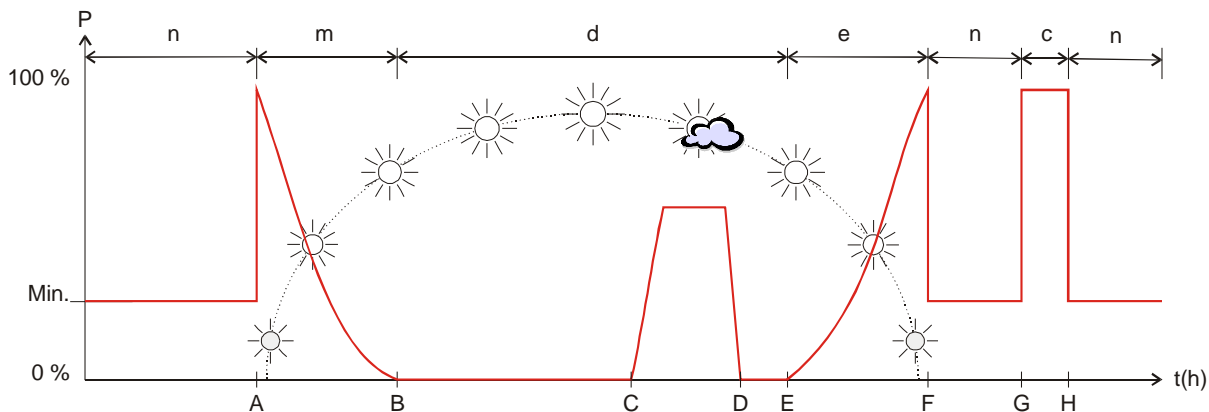

Table 6.2

A	The forced operation is deactivated by the timer/supervisor. The daytime light is still too weak, the brightness regulator powers the dimmer with voltage
B	The daytime light is now sufficient for guaranteeing room lighting and the dimmer is turned off
C	Heavy clouds, the dimmer compensates for the sunlight that is too weak
I	Full sunlight, the dimmer is deactivated
AND	Late afternoon, the dimmer progressively replaces the daytime light, which becomes increasingly weak
F	The forced operation is activated by the timer/supervisor The dimmer reduces the light to 20%
G	Centralised permanently ON = 1
H	Centralised permanently ON = 0
or	During the night, the value configured for forced operation is applied
c	Night-time patrol of surveillance personnel: the light is turned on with the centralised permanently ON function
m	Morning: the light of the day increases and the brightness regulator progressively reduces the adjustment value
and	Evening: the light of the day decreases and the brightness regulator progressively increases the adjustment value
d	During the day, the dimmer is regulated by the brightness regulator depending on the intensity of the sunlight

## 6.3 Brightness control of the energy-savings lamps (LRE)

### 6.3.1 General

The energy saving lamps normally found in stores cannot be regulated, except in cases when expressly indicated as such.



These lamps have differences related to the manufacturer and the type. In particular, in the case of cold lamps, there are differences in terms of the switch-on brightness and the switch-on capacity. Even though the LRE mode of the GWA9303 dimmer contemplates the specific characteristics of adjustable energy saving lamps, there are some points to keep in mind.

- In principle, the parallel connection of LRE lamps is possible; however, it is recommended to operate in parallel only lights of the same time on one channel.
- The maximum power of each channel is 400 W (trailing edge phase control/RC mode), 80 W (leading edge phase control/L mode). In parallel operation, the maximum power of the two channels is 800 W (trailing edge phase control/RC mode), 140 W (leading edge phase control/L mode).
- The minimum power per channel is 5 W
- A quick decrease in brightness (e.g. configured start, adjustment value from 100% to 20%) can determine intermittence also in the case of "warm" lights.
- Brightness values that are too low (below 20%, partially also below 35%) can determine intermittence. Intermittence, such as the switch on/switch off processes, negatively influences the lifespan of the lamp.
- When using automatic switches (movement/presence detectors), the minimum operating duration of an LRE in indoor environments should not be set to less than 5 minutes and, in outdoor environments, to less than 10 minutes. This prevents frequent switch on/switch off processes and increases the lifespan of the lamp.

To prevent adjustable LREs from flickering when turning on or from not turning on correctly, they are always turned on with a high brightness value, then the brightness is reduced to the value desired by the user.

This compensates for the fact that the warm LSEs have a reduced switch on brightness value:

Depending on the manufacturer, the type and the room temperature, it may take them up to 5 minutes before reaching maximum brightness.

To be able to adjust the brightness of the LSEs, the GWA9303 dimmer offers two special modes for adjustable energy saving lamps with RC or L behaviour.

These modes also consider the different characteristic curve of the LREs with respect to incandescent lamps, that is the ratio between the set percentage value and the emitted brightness, in reference to maximum brightness.

#### **IMPORTANT:**

In the case of some LED lights, it is not possible to decrease the brightness if the adjustment value is set to > 90 %. With the GWA9303 device, it is possible to adjust these lights. For this reason, the LED load control selection is used (RC, 0-90 %).

### **6.3.2 Behaviour selection RC or L:**

In addition to the LSE manufacturer's recommendations for the relative type of lamp, the following applies:

- **RC mode:** recommended in general for LRE and in particular for high loads (advantage: little heat is developed in the dimmer).
- **Mode L:** use for LRE only in case of an intermittence problem when increasing or decreasing brightness.

### 6.3.3 Adjustable RC energy saving lamps (Trailing edge phase control)

With this parameter setting, it is possible to adjust the brightness of adjustable RC energy saving lamps.

Energy saving lamps always start with 100% of the power and then decrease automatically to 95% after 3 seconds. After another 30 seconds, the LRE is hot enough and the brightness can be reduced to the minimum.

- Minimum settable brightness = 1% In energy saving lamps, depending on the type, a minimum brightness between 20% and 35% makes sense (if lower, the lamps flash or turn off).
- If the LRE is turned off when hot for more than 30 seconds, after turning it on the heating phase will be shorter. The duration of the heating phase corresponds in this case to the time it was turned off previously.
- This configuration is optimal for MEGAMAN lamps, for example.

This creates the following correlation between the time elapsed since it was turned on and the minimum adjustment value possible:

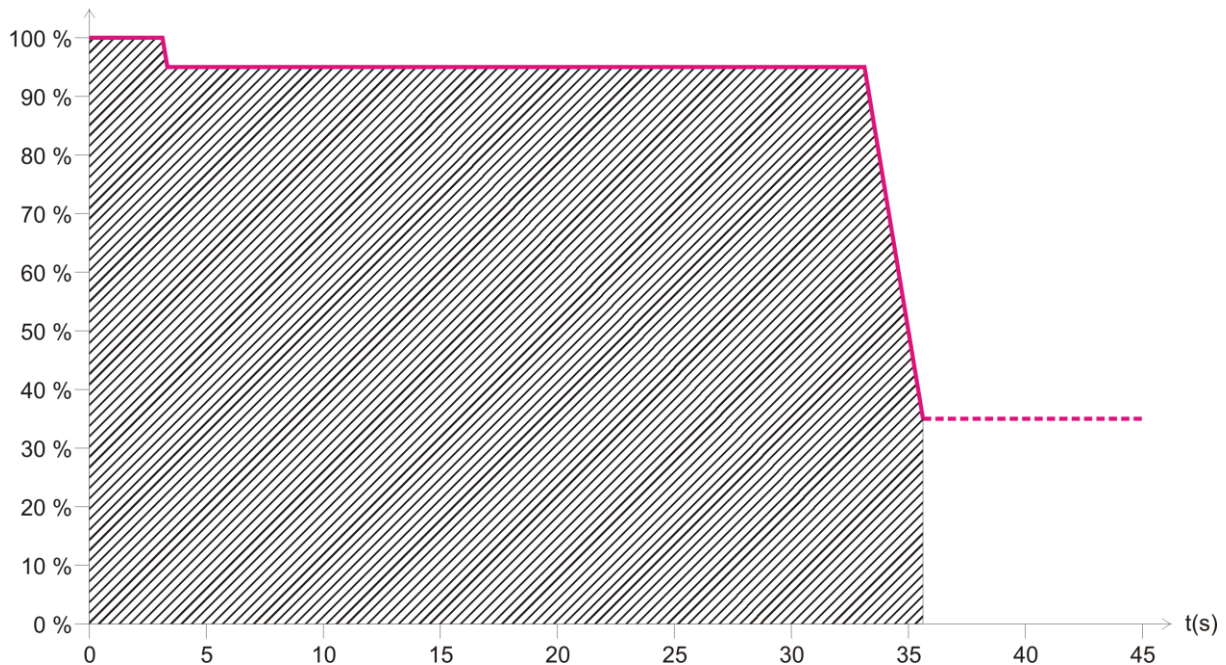

Independently of the requested adjustment value, values in the area with the dotted line are not permitted.

**NB:**

Connecting a load L in RC mode could disturb the dimmer, load recognition is always carried out as a guarantee. The RC mode is used effectively only if no load L is recognised.

### 6.3.4 Adjustable L energy saving lamps (leading edge phase control)

With this parameter setting, it is possible to adjust the brightness of adjustable L energy saving lamps. No load recognition is carried out, but adjustment always takes place with phase control.

- The energy saving lamp always starts with at least 85% of the power, then, after 1 second, decreases automatically to minimum brightness.
- Minimum settable brightness = 1% In energy saving lamps, depending on the type, a minimum brightness between 20% and 35% makes sense (if lower, the lamps flash or turn off).
- This configuration is optimal for OSRAM lamps, for example.

This creates the following correlation between the time elapsed since it was turned on and the minimum adjustment value possible:

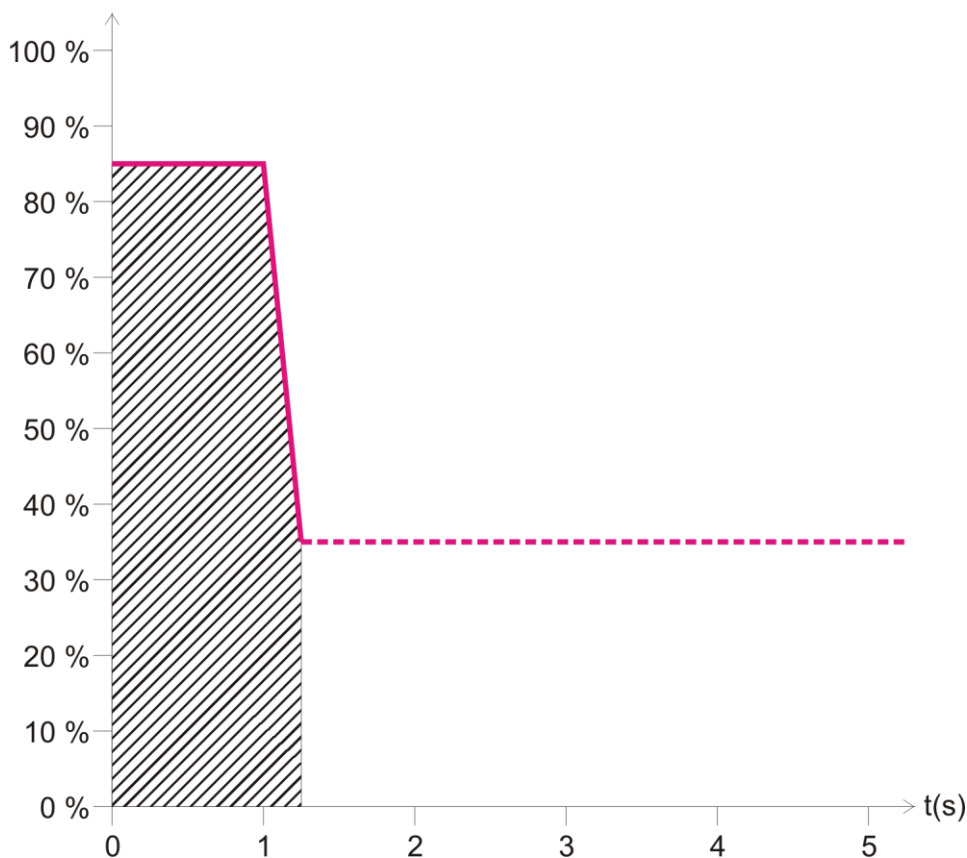

Independently of the requested adjustment value, values in the area with the dotted line are not permitted.

#### Indications:

- some types of lamps can cause an overload in L mode and cause the automatic decrease of the output brightness.
- Some LRE cannot be used in L mode due to impermissible disturbance voltages. In both cases, it is necessary to select the automatic recognition of the load (RC mode).

## 6.4 *Brightness control of energy saving LED lamps*

### 6.4.1 General

With the dimmer, only LED lamps for 230 V networks can be used (so-called retrofit lamps) that are specifically indicated as adjustable.

As regards the brightness adjustment behaviour, these lamps have differences depending on the manufacturer or the type, therefore it is recommended to only use the same type of lights in parallel in the same channel.

- The maximum power of each channel is 400 W (trailing edge phase control/RC mode), 60 W (leading edge phase control/L mode). In parallel operation, the maximum power of the two channels is 800 W (trailing edge phase control/RC mode), 120 W (trailing edge phase control/L mode).
- The minimum power per channel is 5 W.

It may be necessary to adapt the "minimum adjustment value" for each parameter.

### 6.4.2 Behaviour selection RC or L:

In addition to the LED lamp manufacturer's recommendations for the relative type of lamp, the following applies: LED lamps typically function in RC mode to reduce the connection currents that can disturb the power supply network. Therefore the RC mode is recommended especially for high power levels. Additional advantage: less heat is developed in the dimmer.

#### **Mode L:**

use for LEDs only in case of an intermittence problem when increasing or decreasing brightness.

#### **NB:**

some types of lamps can cause an overload in L mode and cause the automatic decrease of the output brightness. **In that case, it is necessary to select the automatic recognition of the load (RC mode).**

## 6.5 4-bit telegram (Brighter/darker)

### 6.5.1 Relative adjustment 4 bit telegram format DPT 3.007 (dimming control)

Table 6.5.1

Bit 3	Bit 2	Bit 1	Bit 0
Direction		Adjustment range divided in levels	
		Code	Levels
Brightness increase:	1	000	<b>Stop</b>
brightness decrease:	0	001	1
		010	2
		011	4
		100	8
		101	16
		110	32
		111	64*

\*Typical application

Examples: 1111 = increase the brightness 64 levels  
 0111 = decrease the brightness 64 levels  
 1111 = increase the brightness 16 levels

### 6.5.2 Parameter "Switching ON/OFF with a 4-bit dim telegram"

In general, this parameter must be set to "yes".  
 For special requirements, such as conference rooms, "no" can be set.  
 The situation is described below.

An entire dimmer channel group is commanded by a push-button (4 bit).  
 A certain lighting situation was set previously via a scene or in another manner, e.g. channel 1 off, channel 2 40%, channel 3 50%. At this point, the brightness of the entire scene should be increased, while keeping switched off the channels set to OFF.

The "**Switching ON/OFF with a 4-bit dim telegram**" parameter blocks the normal switching on/off function of the 4 bit telegram.

Table 6.5.2

"Switching ON/OFF with a 4-bit dim telegram" parameter	4 bit Telegram	Initial dimmer status	Reaction
yes	brighter/darker	On (1%...100%)	The channel is adjusted normally (to 0%* or to 100%).
	brighter	Off	The channel is turned on and adjusted
no	brighter/darker	Off	The dimmer remains off
	brighter/darker	on (1%...100%)	The channel is adjusted between the min. and 100%

\* With the "darker" 4-bit telegram, the channel is turned off if, when reaching minimum brightness, the push-button is hold down for more than approx. 2 seconds.

## 6.6 Scenes

### 6.6.1 Principle

With the scene function, it is possible to save the momentary status of a channel and restore it later. This concerns both the blind switching channels as well as the brightness adjustment. Each channel can participate in max. 8 scenes at the same time.

For this purpose, participation in the scenes must be allowed in the parameter for the respective channel (see the “**Activate scenes**” parameter and the **Scenes**) menu.

When saving a scene, the current status is assigned to the number of the selected scene. When the scene number is recalled, the status saved previously is restored.

The scenes are saved permanently and can be maintained permanently also after a new download of the application (see the “**All scene statuses of channel**” parameter in the **Scenes**) menu.

### 6.6.2 Recall and/or save scenes:

To recall and/or save a centralised scene, the corresponding code is sent to the scene object **Central recall/save scenes** (DPT 18.001 Scene) or the scenes can be saved and recalled with the object dedicated to each channel **Channel CHx – Call up/save scenes** (DPT 18.001 Scene). The hexadecimal/decimal coding when recalling or saving scenes via these objects is provided in the following table.

Table 6.6.2

Scene	Recall		Save	
	Hexad.	Dec.	Hexad.	Dec.
1	\$00	0	\$80	128
2	\$01	1	\$81	129
3	\$02	2	\$82	130
4	\$03	3	\$83	131
5	\$04	4	\$84	132
6	\$05	5	\$85	133
7	\$06	6	\$86	134
8	\$07	7	\$87	135
9	\$08	8	\$88	136
10	\$09	9	\$89	137
11	\$0A	10	\$8A	138
12	\$0B	11	\$8B	139
13	\$0C	12	\$8C	140
14	\$0D	13	\$8D	141
15	\$0E	14	\$8E	142
16	\$0F	15	\$8F	143
17	\$10	16	\$90	144
18	\$11	17	\$91	145
19	\$12	18	\$92	146
20	\$13	19	\$93	147
21	\$14	20	\$94	148
22	\$15	21	\$95	149
23	\$16	22	\$96	150
24	\$17	23	\$97	151

25	\$18	24	\$98	152
26	\$19	25	\$99	153
27	\$1A	26	\$9A	154
28	\$1B	27	\$9B	155
29	\$1C	28	\$9C	156
30	\$1D	29	\$9D	157
31	\$1E	30	\$9E	158
32	\$1F	31	\$9F	159
33	\$20	32	\$A0	160
34	\$21	33	\$A1	161
35	\$22	34	\$A2	162
36	\$23	35	\$A3	163
37	\$24	36	\$A4	164
38	\$25	37	\$A5	165
39	\$26	38	\$A6	166
40	\$27	39	\$A7	167
41	\$28	40	\$A8	168
42	\$29	41	\$A9	169
43	\$2A	42	\$AA	170
44	\$2B	43	\$AB	171
45	\$2C	44	\$AC	172
46	\$2D	45	\$AD	173
47	\$2E	46	\$AE	174
48	\$2F	47	\$AF	175
49	\$30	48	\$B0	176
50	\$31	49	\$B1	177
51	\$32	50	\$B2	178
52	\$33	51	\$B3	179
53	\$34	52	\$B4	180
54	\$35	53	\$B5	181
55	\$36	54	\$B6	182
56	\$37	55	\$B7	183
57	\$38	56	\$B8	184
58	\$39	57	\$B9	185
59	\$3A	58	\$BA	186
60	\$3B	59	\$BB	187
61	\$3C	60	\$BC	188
62	\$3D	61	\$BD	189
63	\$3E	62	\$BE	190
64	\$3F	63	\$BF	191

**Examples** (centr. and/or ref. to channel):

Recall the status of scene 5:

→ send \$04 to the respective scene object.

Save the current status with scene 5:

→ send \$84 to the respective scene object.

### 6.6.3 Enter scene without telegrams

Instead of defining the scenes individually by telegram, they can be programmed directly in ETS using the relative parameters.

For this purpose, only set the “**All scene statuses of channel**” parameter (parameter page *Scenes*) to *Overwrite when downloading*.

It will then be possible to select the desired status for each of the 8 possible scene numbers of a channel. After the download, the scenes are already programmed in the device.

It is possible to change them later using teaching telegrams only if necessary and may be permitted and/or locked via the “**Permit teach-in**” parameter.



## 6.7 Saving light scenes via a push-button

The scenes are saved according to the dedicated parameter settings for each GWA9303 channel. The object **Channel CH1 – Call up/save scenes** (o **CH2 – Call up/save scenes**) DPT (17.001 scene number) is used for this purpose

If, however, in order to save the lights **externally**, that is via a push-button that is able to send the scenes, proceed as follows:

- GWA9303 had an adjustment object (adjustment value) and a feedback object (feedback %) for each channel.
- In this way, 2 group addresses are used, called "Add.gr.1" and "Add.gr.2" below.

### 6.7.1 Assignment of the group addresses and setting of the object flags

	Object	Connect with	Set transmission	Flag*			
				C	R	W	N
PUSH-BUTTON	Brightness value telegram	Add.gr.1	yes				
		Add.gr.2	no	<input type="checkbox"/>	-	<input type="checkbox"/>	<input type="checkbox"/>
DIMMER	Adjustment value	Add.gr.1	x	<input type="checkbox"/>	-	<input type="checkbox"/>	x
	Feedback in %	Add.gr.1	no	<input type="checkbox"/>			
		Add.gr.2	yes	<input type="checkbox"/>	<input type="checkbox"/>	-	x

\* Obj. flag: Switching, read, write, transmission, update.

x = any

The dimmer feedback must **not** be configured to *Cyclical transmission*.

### 6.7.2 Description of the operation

#### Saving a scene:

- The push-button sends to Add.gr.1 the reading order for the responses received only from the object "**Feedback in %**" and with Add.gr.2.
- Add.gr.2 is not processed by the object "**Dimming value**".
- The push-button, however, receives the value and saves it for the relative scene.

#### Recalling a scene:

- The push-button transmits the value as a % saved for the scene to the object **Dimming value** with the transmission address Add.gr.1.
- The value of the object "**Dimming value**" is processed to set the initial brightness.
- When the dimmer has set the requested value, depending on the configuration it transmits the status indication with the object "**Feedback in %**".

## 6.8 Conversion of the percentages into hexadecimal and decimal values

Table 6.8

Percentage value	0%	10%	20%	30%	40%	50%	60%	70%	80%	90%	100%
Hexadecimal	00	1A	33	4D	66	80	99	B3	DC	E6	FF
Decimal	00	26	51	77	102	128	153	179	204	230	255

All the values from 00 to FF hexa. (from 0 to 255 dec.).

## 6.9 Flow chart

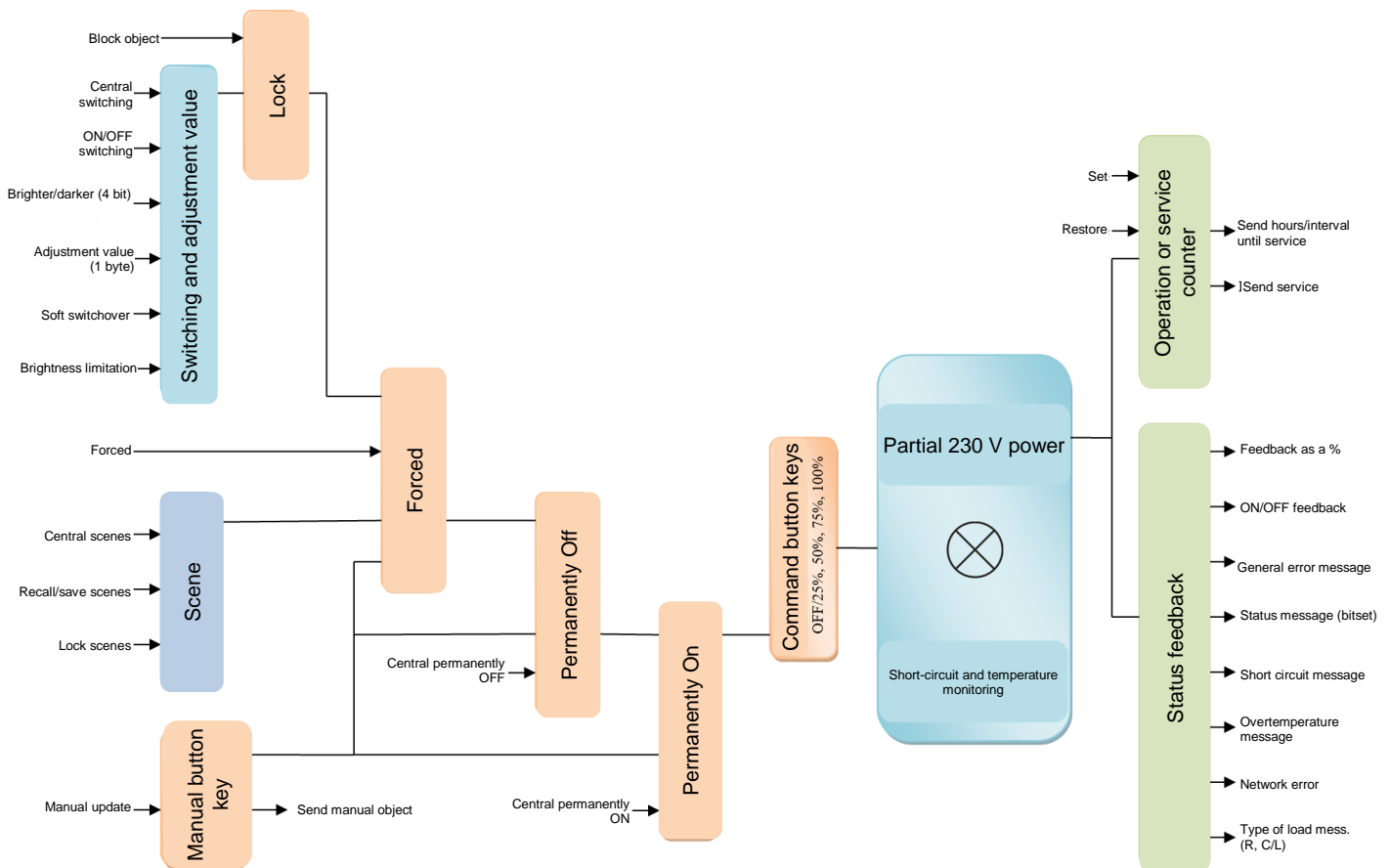

## 7 Annex 3: Technical data and manual command

### 7.1 Technical data

KNX operating voltage	BUS voltage $\leq 4$ mA
Operating voltage	230 V AC +10 % -15 %
Frequency	50 Hz
Stand-by power	0.9W
Width	4 DIN modules
Assembly type	DIN profile
Type of connection	Screw terminals
Max. cable section	Full: from 0.5 mm <sup>2</sup> ( $\varnothing$ 0.8) to 4 mm <sup>2</sup> Cable with coupling: from 0.5 mm <sup>2</sup> to 2.5 mm <sup>2</sup>
No. of channels	2
Type of lamps	Incandescent, halogen and high and low voltage lamps, adjustable energy saving lamps and LED
Switching power for each channel	400W
Switching power in parallel operation	800W
Switching power of the adjustable energy saving lamps for each channel	Trailing edge phase control (RC mode): 400 W   Leading edge phase control (L mode): 80W
Switching power of the adjustable energy saving lamps in parallel operation	Trailing edge phase control (RC mode): 800 W   Leading edge phase control (L mode): 140W
Switching power of the adjustable 230 V LEDS for each channel	Trailing edge phase control (RC mode): 400 W   Leading edge phase control (L mode): 60W
Switching power of the adjustable 230 V LEDS in parallel operation	Trailing edge phase control (RC mode): 800 W   Leading edge phase control (L mode): 120 W
Min. switching power	5W
Max. line length	100m
Ambient temperature	-5°C / +45°C
Type of protection	IP 20
Protection class	II according to EN 60 669

For more information and for the wiring, refer to the Instruction Manual of the device.

## 7.2 Manual command and LED on the device

Each dimmer actuator has a manual button key ("man").  
If manual mode is activated, the dimmer can be controlled only using the button keys.  
Bus telegrams are not executed.

4 button keys and 4 LEDs are available for each channel.

The LEDs indicate the current status as a bar diagram:

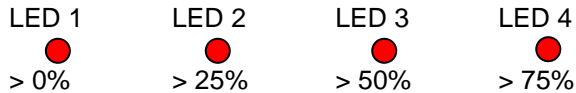

In the case of an overtemperature or a short circuit, the load is lowered to 0%.

The button keys recall the following brightness adjustment values:

**Table 7.2:**

Button key 1	Button key 2	Button key 3	Button key 4
25% or off	50%	75%	100%

### In normal operation:

Pressing a button key obtains the desired brightness adjustment value.  
Via the bus, it is possible at any moment to overwrite a status that was created via the channel button key.

### In manual operation with the manual button key or object *CH1 + CH2 - Manual*:

If the "manual" function is selected, the relative LED illuminates.  
Any timing functions in progress (e.g. soft switching) are ended.  
The brightness adjustment status is frozen and can be changed only via the channel button keys.  
Bus telegrams are no longer executed.

The "manual" status is reset in case of a power failure. After cancelling manual operation, the bus events that were already received are not recovered.

## 8 Annex 4: Communication objects

The following table summarises all the communication objects with their specific ID numbers, names and functions displayed in ETS, plus a brief description of the function and the type of Datapoint.

### Output objects

No.	Object name	Object function	Description	DPT Type
9	Channel CH1	Feedback ON/OFF	ON/OFF Feedback CH1	DPT 1.001
10	Channel CH1	Feedback in %	Feedback as a % CH1	DPT 5.001
11	Channel CH1	Time to next service	Transmits the time remaining until next service	DPT 7.001
	Channel CH1	Operating hours feedback	Transmits the operating time CH1	
12	Channel CH1	Service required	Transmits the service required message	DPT 1.001
14	Channel CH1	General error message	Transmits the general device error diagnostic message	DPT 1.001
15	Channel CH1	Short circuit message	Transmits the short circuit diagnostic message	DPT 1.001
16	Channel CH1	Excess temperature message	Transmits the excess temperature diagnostic message	DPT 1.001
17	Channel CH1	Mains power failure	Transmits the power failure or hardware error message	DPT 1.001
18	Channel CH1	Load type message (RC/L)	Transmits the connected load type (RC/L) message	DPT 1.001
39	Channel CH2	Feedback ON/OFF	Feedback ON/OFF status CH1	DPT 1.001
40	Channel CH2	Feedback in %	Status feedback in % CH1	DPT 5.001
41	Channel CH2	Time to next service	Transmits the time remaining until next service	DPT 7.001
	Channel CH2	Operating hours feedback	Transmits the operating time CH1	
42	Channel CH2	Service required	Transmits the service required message	DPT 1.001
44	Channel CH2	General error message	Transmits the general device error diagnostic message	DPT 1.001
45	Channel CH2	Short circuit message	Transmits the short circuit diagnostic message	DPT 1.001
46	Channel CH2	Excess temperature message	Transmits the excess temperature diagnostic message	DPT 1.001
47	Channel CH2	Mains power failure	Transmits the power failure or hardware error message	DPT 1.001
48	Channel CH2	Load type message (RC/L)	Transmits the connected load type (RC/L) message	DPT 1.001
78	CH1 + CH2	Manual	Switches and sends the device status in manual mode	DPT 1.001
250	BCU version	Transmit	Transmits the sw version bus coupler	DPT 16.001
251	Version CH1 + CH2	Transmit	Transmits the device fw/sw version	DPT 16.001

## Input objects

No.	Object name	Object function	Description	DPT type
0	Channel CH1	Switching ON/OFF	Reception switching ON/OFF of channel 1	DPT 1.001
1	Channel CH1	Brighter/darker	Reception brighter/darker adjustment of channel 1	DPT 3.007
2	Channel CH1	Dimming value	Reception adjustment value in % channel 1	DPT 5.001
3	Channel CH1	Soft switching	Soft switching of channel 1	DPT 1.001
4	Channel CH1	Lock	Reception of the lock command channel 1	DPT 1.001
5	Channel CH1	Call up/save scenes	Call up and save scenes channel 1	DPT 18.001
6	Channel CH1	Lock scenes = 1	Scene function lock command channel 1	DPT 1.001
		Enable scenes = 1	Scene enable (release) command channel 1	
7	Channel CH1	Force = 1	Reception of force command with object = 1 – channel 1	DPT 1.001
	Channel CH1	Force = 0	Reception of force command with object = 0 – channel 1	
	Channel CH1	Forced mode	Reception of force command with 2 bit object – channel 1	DPT 2.001
	Channel CH1	Dimming value with forced op	Reception of force command with 1 byte object with forcing value – channel 1	DPT 5.001
8	Channel CH1	Dimming value limit	Reception of maximum settable adjustment value – channel 1	DPT 5.002
13	Channel CH1	Reset service	Reset regressive counter for next service – channel 1	DPT 1.001
		Reset operating hours	Reset operating hours counter – channel 1	DPT 1.001
30	Channel CH2	Switching ON/OFF	Reception switching ON/OFF of channel 2	DPT 1.001
31	Channel CH2	Brighter/darker	Reception brighter/darker adjustment of channel 2	DPT 3.007
32	Channel CH2	Dimming value	Reception adjustment value in % channel 2	DPT 5.001
33	Channel CH2	Soft switching	Soft switching of channel 2	DPT 1.001
34	Channel CH2	Lock	Reception of the lock command channel 2	DPT 1.001
35	Channel CH2	Call up/save scenes	Call up and save scenes channel 2	DPT 18.001
36	Channel CH2	Lock scenes = 1	Scene function lock command channel 2	DPT 1.001
		Enable scenes = 1	Scene enable (release) command channel 2	
37	Channel CH2	Force = 1	Reception of force command with object = 1 – channel 2	DPT 1.001
	Channel CH2	Force = 0	Reception of force command with object = 0 – channel 2	
	Channel CH2	Forced mode	Reception of force command with 2 bit object – channel 2	DPT 2.001

	<i>Channel CH2</i>	<i>Dimming value with forced op</i>	<i>Reception of force command with 1 byte object with forcing value – channel 2</i>	<i>DPT 5.001</i>
38	<i>Channel CH2</i>	<i>Dimming value limit</i>	<i>Reception of maximum settable adjustment value – channel 2</i>	<i>DPT 5.001</i>
43	<i>Channel CH2</i>	<i>Reset service</i>	<i>Reset regressive counter for next service – channel 2</i>	<i>DPT 1.001</i>
		<i>Reset operating hours</i>	<i>Reset operating hours counter – channel 2</i>	<i>DPT 1.001</i>
78	<i>CH1 + CH2</i>	<i>Manual</i>	<i>Switches and sends the device status in manual mode</i>	<i>DPT 1.001</i>
240	<i>Central permanent ON</i>	<i>Receive</i>	<i>Centralised switching to ON of all channels</i>	<i>DPT 1.001</i>
241	<i>Central permanent OFF</i>	<i>Receive</i>	<i>Centralised switching to OFF of all channels</i>	<i>DPT 1.001</i>
242	<i>Central switching</i>	<i>Receive</i>	<i>Centralised ON/OFF switching of all channels</i>	<i>DPT 1.001</i>
243	<i>Central recall/save scenes</i>	<i>Receive</i>	<i>Recall and save of centralised scenes</i>	<i>DPT 18.001</i>

Punto di contatto indicato in adempimento ai fini delle direttive e regolamenti UE applicabili:

*Contact details according to the relevant European Directives and Regulations:*

**GEWISS S.p.A. Via A.Volta, 1 IT-24069 Cenate Sotto (BG) Italy tel: +39 035 946 111 E-mail: [qualitymarks@gewiss.com](mailto:qualitymarks@gewiss.com)**



**+39 035 946 111**

8.30 - 12.30 / 14.00 - 18.00  
lunedì ÷ venerdì - monday ÷ friday



**+39 035 946 260**



**[sat@gewiss.com](mailto:sat@gewiss.com)**  
**[www.gewiss.com](http://www.gewiss.com)**