

PRODUCT DATASHEET

PL PROT 600 P 36W 830 PS

PANEL PROTECT 600 PS | Square recessed panel luminaires with IP54 protection and power select (PS) feature, 600 x 600 mm

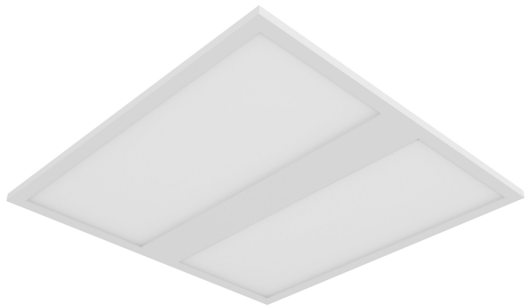

Areas of application

- Direct replacement for luminaires with fluorescent lamps
- Suitable for recessed ceiling systems with grid size of 600 x 600 mm
- Hospitals
- Laboratories
- Kitchens, canteens, workspaces

Product benefits

- Suitable for use in applications where a higher IP protection is needed
- Highly versatile due to selectable power steps (Power Select - PS) on the driver and up to 5040 lm
- Tool-free electrical connection due to push button connector
- Through-wiring possible with included connector box
- Energy savings thanks to high system efficacy: up to 140 lm/W
- High color consistency with SDCM 3
- Extended services such as energy monitoring and remote maintenance possible with DALI versions
- External driver for extended flexibility and easy installation
- Easy cleanable frontside thanks to the smooth PMMA surface of the diffuser
- Suitable for battery emergency installations acc. to EN 60598-2-22
- Decentral emergency lighting possible with separately available LEDVANCE Emergency Conversion Box
- 5 years guarantee

Product features



- Type of protection: IP54 (frontside), IP20 (backside)
- Steel housing with notch in the backside for the driver to allow maximum height of 34 mm
- PMMA diffuser
- 5-pole terminal block, cable cross section up to 5 x 2.5 mm²
- Luminaire versions with IoT-ready DALI-2 driver available
- Lifetime (L90/B10): 50,000 h (at 25° C)
- Panel can be customized with optical sensors on individual request

TECHNICAL DATA

Electrical data

| | |
|---|---|
| Nominal wattage | 36 W / 31 W / 26 W / 22 W ¹⁾ |
| Nominal voltage | 220...240 V |
| Mains frequency | 0/50/60 Hz |
| Nominal current | 165.000 mA |
| Inrush current | 0.2 A |
| Inrush current time T_{h50} | 450 μ s |
| Max. number of luminaires per miniature circuit breaker B16 | 16 |
| Max. number of luminaires per miniature circuit breaker C10 | 24 |
| Max. number of luminaires per miniature circuit breaker C16 | 38 |
| Power factor λ | > 0.90 |
| Total harmonic distortion | < 20 % |
| Protection class | II |
| Operating mode | External LED driver |

¹⁾ The Panel Protect family is fulfilling the technical minimum requirements according to the German BEG subsidy program for energy efficient luminaires

Photometrical data

| | |
|--|---|
| Luminous flux | 5040 lm / 4340 lm / 3640 lm / 3080 lm ¹⁾ |
| Luminous efficacy | 140 lm/W ¹⁾ |
| Color temperature | 3000 K |
| Light color (designation) | Warm White |
| Color rendering index Ra | > 80 |
| Standard deviation of color matching | 3 sdc _m |
| Low flicker | Yes |
| Flickering metric (Pst LM) | <1 |
| Stroboscope effect metric (SVM) | < 0.4 |
| Photobiological safety group acc. to EN62778 | RG0 |
| Photobiological safety group acc. to EN62471 | RG0 |
| Beam angle | 120 ° |

¹⁾ The Panel Protect family is fulfilling the technical minimum requirements according to the German BEG subsidy program for energy efficient luminaires

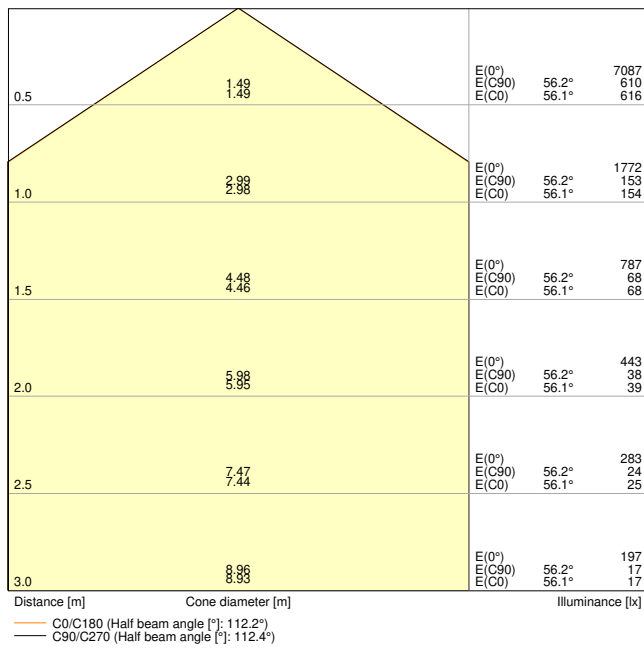

PL PROT 600 P 22W 830 PS 3080lm

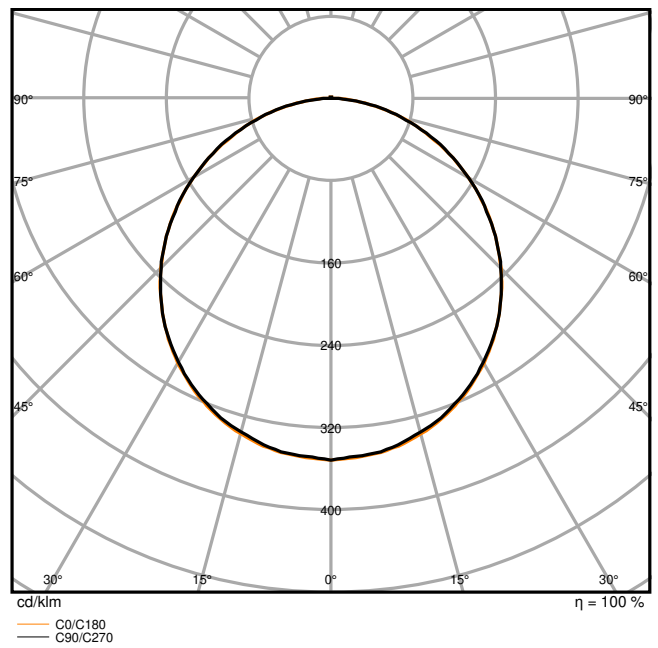

PL PROT 600 P 22W 830 PS 3080lm

Dimensions & Weight

| | |
|----------------|-----------|
| Length | 595.00 mm |
| Width | 595.00 mm |
| Height | 34.00 mm |
| Product weight | 2020.00 g |

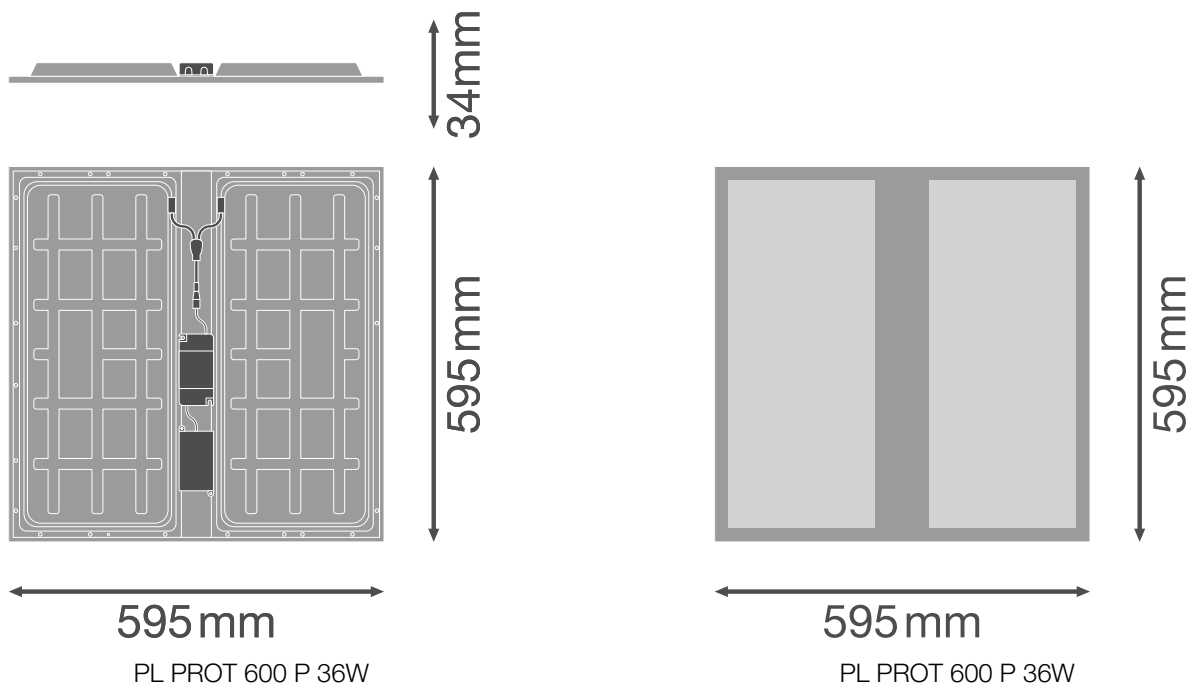

Materials & Colors

| | |
|--|-------------------------------|
| Product color | White |
| Housing color | White |
| Body material | Steel |
| Cover material | Polymethylmethacrylate (PMMA) |
| Light emitting surface material | Polymethylmethacrylate (PMMA) |
| Glow Wire Test according to IEC 60695-2-12 | 650 °C |
| Mercury content | 0.0 mg |

Application & Mounting

| | |
|--|---|
| Ambient temperature range | -10...+50 °C |
| Temperature range at storage | -20...+70 °C |
| Type of connection | Screwless terminal, 5-Pole (L, N, PE, DA+, DA-) |
| Type of protection | IP54/IP20 |
| Protection class IK (shock resistance) | IK02 |
| Dimmable | No |
| Mounting type | Recessed/Suspended/Surface |
| Mounting location | Ceiling |

| | |
|-------------------------|---------|
| Application environment | Indoor |
| Mounting length | 575 mm |
| Mounting width | 575 mm |
| Mounting depth | 50,0 mm |
| Adjustable | No |
| With light source | Yes |

Lifespan

| | |
|----------------------------|------------------------|
| Lifespan L70/B50 at 25 °C | 100000 h ¹⁾ |
| Lifespan L80/B10 at 25 °C | 70000 h ¹⁾ |
| Lifespan L80/B50 at 25 °C | 70000 h |
| Lifespan L90/B10 at 25 °C | 50000 h |
| Number of switching cycles | 100000 |

¹⁾ t[h]: L70 / B50 @ 25 °C (Ta), t[h]: L80 / B10 @ 25 °C (Ta), t[h]: L90 / B10 @ 25 °C (Ta)

Control gear

| | |
|-----------------------------|--|
| Output current | 800 mA |
| ECG - Output ripple current | < 5 % |
| ECG - Length | 125,0 mm |
| ECG - Width | 60 mm |
| ECG - Height | 26,7 mm |
| Recommended control gear | OSRAM OTi_DALI_50/220-240/1A4 NFC / TRIDONIC LCA 45W 500-1400mA one4all SC PRE |

Certificates & Standards

| | |
|--|----------------------------------|
| Standards | CE / CB / ENEC / UKCA / EAC / EL |
| Luminaire with limited surface temperature, "D sign" | No |
| Ball shot safe | No |
| Replaceable light source (EPREL) | Not replaceable |

Additional product data















| | |
|----------------|--------------|
| Added function | MULTI SELECT |
|----------------|--------------|

EQUIPMENT / ACCESSORIES

- Accessories for several mounting options available
- Connector box with 5-pole terminal pre-installed
- Security rope for luminaire included

- Security brackets preinstalled
- External control gear included
- Suitable for use with separate Emergency Conversion Box
- Special mounting frame with an overall height of only 50 mm available separately

DOWNLOAD DATA

| Documents and certificates | | Document name |
|--|--|--|
|  | User instruction / safety instructions | UI PL PROT 600 P 36W and PL PROT 625 P 36W |
|  | Legal information | LSI PL PROT P 36W |
|  | Legal information | Informationstext 18 Abs 4 ElektroG |
|  | Legal information | EM Insert PL PROTECT |
|  | Declarations of conformity | CE Declaration PL PROT |
|  | Declarations of conformity UKCA | UKCA Declaration PL PROT |
| Photometric and lighting design files | | Document name |
|  | IES file (IES) | PL PROT 600 P 22W 830 PS 3080lm |
|  | LDT file (Eulumdat) | PL PROT 600 P 22W 830 PS 3080lm |
|  | ULD file (DIALux) | PL PROT 600 P 36W 830 PS |
|  | ROLF file (RELUX) | SF CIRC 500 V DALI 42W 840 IP44 |
|  | UGR file (UGR table) | PL PROT 600 P 22W 830 PS 3080lm |
|  | Light distribution curve type cone | PL PROT 600 P 22W 830 PS 3080lm |
|  | Light distribution curve type polar | PL PROT 600 P 22W 830 PS 3080lm |
| CAD/BIM files | | Document name |
|  | BIM Revit 3D | PL PROT |
|  | CAD STEP 3D | PL PROT 600 |

| CAD/BIM files | Document name |
|---|------------------------------------|
| | |
| Tender texts | Document name |
|  Tender documents | PANEL PROTECT 600 PS 36W 830 PS-EN |

LOGISTICAL DATA

| Product code | Packaging unit (Pieces/Unit) | Dimensions (length x width x height) | Gross weight | Volume |
|---------------|------------------------------|--------------------------------------|--------------|-----------------------|
| 4099854082863 | Folding box 1 | 41 mm x 602 mm x 602 mm | 2408.00 g | 14.86 dm ³ |
| 4099854082870 | Shipping box 5 | 620 mm x 229 mm x 631 mm | 13122.00 g | 89.59 dm ³ |

The mentioned product code describes the smallest quantity unit which can be ordered. One shipping unit can contain one or more single products. When placing an order, for the quantity please enter single or multiples of a shipping unit.

ADDITIONAL CATALOG INFORMATION

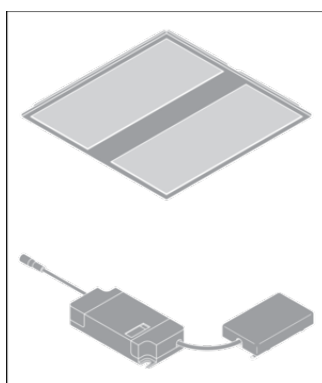
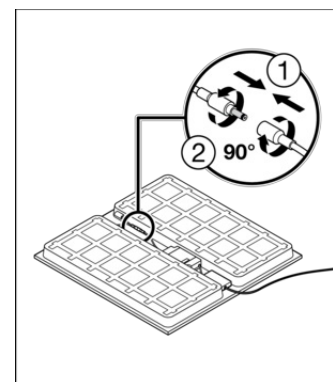
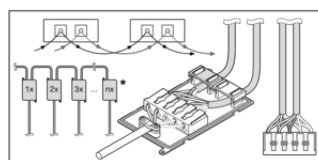
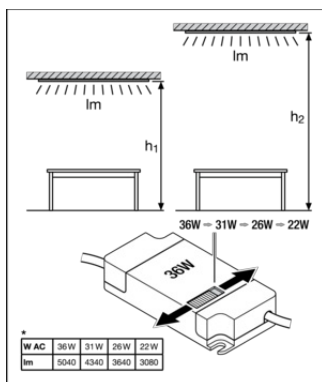

References / Links

– For Guarantee see www.ledvance.com/guarantee

DISCLAIMER

Subject to change without notice. Errors and omission excepted. Always make sure to use the most recent release.