

Product Data Sheet

GW76869

GW FIT Range



Systems of accessories for electrical installations used for residential, tertiary and industrial applications. The system consists of fasteners for pipes and cables, cable fittings, accessories for rigid pipes (RK Series) and flexible conduit (DF Series). The system include also a wide variety of cable ties (52FS Range) and terminal blocks (44 Range).

IP degree	IP65	Material	Nickel-plated brass
Description	Extension	Type of pitch	PG29-PG36
Male thread	PG29	Female thread	PG36
Operating temperature	-30 +100 °C	Electrocod	3651

DIMENSIONAL

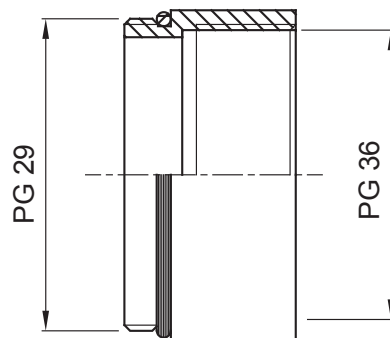

TECHNICAL SYMBOLOGY

IP

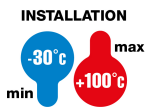

IP65

STANDARDS/APPROVALS

