

# Product Data Sheet

## GW76972

GW FIT Range



Systems of accessories for electrical installations used for residential, tertiary and industrial applications. The system consists of fasteners for pipes and cables, cable fittings, accessories for rigid pipes (RK Series) and flexible conduit (DF Series). The system include also a wide variety of cable ties (52FS Range) and terminal blocks (44 Range).

IP degree	IP65	Material	Nickel-plated brass
Type of pitch	M12	Operating temperature	-30 +100 °C
Electrocod	3651		

### DIMENSIONAL

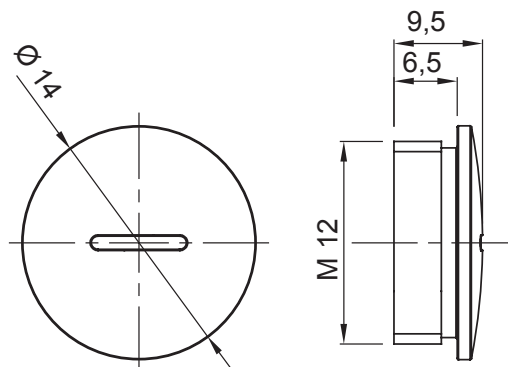

### TECHNICAL SYMBOLOGY

IP

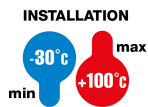

IP65