

Product Data Sheet

GWF1100RH830

ELIA FL



ELIA FL is an LED floodlight, available in medium and high-power versions for outdoor and indoor applications in industrial, tertiary and sports contexts, such as façades, warehouses, car parks and sports fields. Available in 4 different sizes and power steps (50 W, 100 W, 150 W and 200 W), the range allows for great flexibility with its multiple possible combinations: 3 colour temperature options (3,000 K warm white, 4,000 K neutral white and 5,700 K cool white) with a colour rendering index of more than 80; 2 integrated power supply options (On/Off and DALI); and 2 optics options (60° and asymmetrical). The luminaire can be ceiling, wall or floor-mounted through the integrated adjustable steel bracket with a protractor, or pole-mounted (in poles with diameter up to 61 mm) through a dedicated accessory (to be ordered separately). Thanks to its black powder-coated die-cast aluminium body and its front glass, the fixture is tough, durable (IP66 and IK08) and is able to withstand harsh environmental conditions (such as ambient temperature variations from -30°C to +50°C).

GENERAL INFORMATION		OPTIC AND ILLUMINATING FEATURES	
Context	Industry, logistics, facades, sporting facilities and outdoor area lighting	Optic	60°
Luminaire	LED luminaire with mid and high lumen power	Unified Glare Rating	ULOR = 0%
Application	Indoor / Outdoor	Lumen output (lm)	20400
Unique digital code (Datamatrix)	Currently not present	Efficacy (lm/W)	136
Colour	Black	Colour temperature	3000 K
Type of light source	LED	Colour Rendering Index	CRI 80
System power	150 W	Standard Deviation Colour Matching	SDCM = 5
LED Lifetime	L80B50 (Tq=25°C) = 80.000 h	Photobiological Risk Class	RG1
Weight (kg)	3.6	Standard	EN 60598-1; EN 60598-2-5; IEC/TR 62778; EN 62493
Warranty	5 years	ELECTRICAL AND LIGHTING FEATURES	
Stocking temperature	-40° +80°	Supply voltage	220-240 V
Operating temperature	-30°C ÷ +50 °C	Rated frequency (Hz)	50/60 Hz
MATERIALS		Driver	Built-in
Body	Die-cast aluminium	Driver failure rate	F10 (Tq=25°C) > 80.000 h
Shield type	Tempered 4mm-thick surface glass with Gewiss logo	Overvoltage protection	DM 4 kV/ CM 4 kV
Optic	High-efficiency lens and reflector unit	Control System	ON / OFF
Gasket	-	INSTALLATION AND MAINTENANCE	
Locking Hook	-	Mounting and installation	Floodlight mast - Ceiling - Wall - Ground
External screw	Stainless steel	Tilt	Rotation on bracket with integrated goniometer
Colour	Powder coating	Wiring	With power cable
STANDARDS AND APPROVALS		Fixing	Via integrated bracket
Classification	-	Light source replaceability	Non-replaceable
Device with reduced surface temperature	-	Controlgear replaceability	By professional
DIN 18032-3 certification	-	Driver Box	Built-in
IPEA	-	Maximum surface exposed to the wind	0,07 m²
Insulation class	I		Built-in
IP degree	IP66		Built-in
Mechanical resistance	IK08		Built-in
Glow Wire Test	750 °C		Built-in

DIMENSIONAL

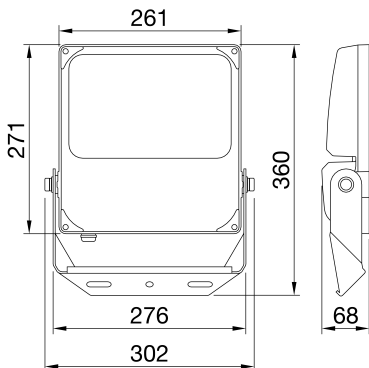

PHOTOMETRIC DISTRIBUTION

TECHNICAL SYMBOLOGY



IP
IP66

IK
IK08

GWT
750 °C

Product Data Sheet
GWF1100RH830

ELIA FL

STANDARDS/APPROVALS

