

Modicon TM3

Transmitter and Receiver Modules

Hardware Guide

12/2017



The information provided in this documentation contains general descriptions and/or technical characteristics of the performance of the products contained herein. This documentation is not intended as a substitute for and is not to be used for determining suitability or reliability of these products for specific user applications. It is the duty of any such user or integrator to perform the appropriate and complete risk analysis, evaluation and testing of the products with respect to the relevant specific application or use thereof. Neither Schneider Electric nor any of its affiliates or subsidiaries shall be responsible or liable for misuse of the information contained herein. If you have any suggestions for improvements or amendments or have found errors in this publication, please notify us.

You agree not to reproduce, other than for your own personal, noncommercial use, all or part of this document on any medium whatsoever without permission of Schneider Electric, given in writing. You also agree not to establish any hypertext links to this document or its content. Schneider Electric does not grant any right or license for the personal and noncommercial use of the document or its content, except for a non-exclusive license to consult it on an "as is" basis, at your own risk. All other rights are reserved.

All pertinent state, regional, and local safety regulations must be observed when installing and using this product. For reasons of safety and to help ensure compliance with documented system data, only the manufacturer should perform repairs to components.

When devices are used for applications with technical safety requirements, the relevant instructions must be followed.

Failure to use Schneider Electric software or approved software with our hardware products may result in injury, harm, or improper operating results.

Failure to observe this information can result in injury or equipment damage.

© 2017 Schneider Electric. All Rights Reserved.

Table of Contents



	Safety Information	5
	About the Book	7
Part I	TM3 General Overview	13
Chapter 1	TM3 Description	15
	General Description	15
Chapter 2	TM3 Installation	19
2.1	TM3 General Rules for Implementing	20
	Environmental Characteristics	21
	Certifications and Standards	24
2.2	TM3 Expansion Module Installation	25
	Installation and Maintenance Requirements	26
	Installation Guidelines	29
	Top Hat Section Rail (DIN rail)	30
	Assembling a Module to a Controller or Receiver Module	34
	Disassembling a Module from a Controller or Receiver Module	36
	Direct Mounting on a Panel Surface	37
2.3	TM3 Electrical Requirements	38
	Wiring Best Practices	39
	Grounding the TM3 System	43
Part II	TM3 Transmitter and Receiver Modules	47
Chapter 3	Compatibility	49
	Compatibility of the TM3 Transmitter and Receiver Modules	49
Chapter 4	TM3XTRA1 Transmitter Module	51
	TM3XTRA1 Presentation	52
	TM3XTRA1 Characteristics	54
	TM3XTRA1 Wiring Diagram	56
Chapter 5	TM3XREC1 Receiver Module	59
	TM3XREC1 Presentation	60
	TM3XREC1 Characteristics	62
	TM3XREC1 Wiring Diagram	64
Glossary	67
Index	71

Safety Information



Important Information

NOTICE

Read these instructions carefully, and look at the equipment to become familiar with the device before trying to install, operate, service, or maintain it. The following special messages may appear throughout this documentation or on the equipment to warn of potential hazards or to call attention to information that clarifies or simplifies a procedure.



The addition of this symbol to a “Danger” or “Warning” safety label indicates that an electrical hazard exists which will result in personal injury if the instructions are not followed.



This is the safety alert symbol. It is used to alert you to potential personal injury hazards. Obey all safety messages that follow this symbol to avoid possible injury or death.

DANGER

DANGER indicates a hazardous situation which, if not avoided, **will result in** death or serious injury.

WARNING

WARNING indicates a hazardous situation which, if not avoided, **could result in** death or serious injury.

CAUTION

CAUTION indicates a hazardous situation which, if not avoided, **could result in** minor or moderate injury.

NOTICE

NOTICE is used to address practices not related to physical injury.

PLEASE NOTE

Electrical equipment should be installed, operated, serviced, and maintained only by qualified personnel. No responsibility is assumed by Schneider Electric for any consequences arising out of the use of this material.

A qualified person is one who has skills and knowledge related to the construction and operation of electrical equipment and its installation, and has received safety training to recognize and avoid the hazards involved.

QUALIFICATION OF PERSONNEL

Only appropriately trained persons who are familiar with and understand the contents of this manual and all other pertinent product documentation are authorized to work on and with this product.

The qualified person must be able to detect possible hazards that may arise from parameterization, modifying parameter values and generally from mechanical, electrical, or electronic equipment. The qualified person must be familiar with the standards, provisions, and regulations for the prevention of industrial accidents, which they must observe when designing and implementing the system.

INTENDED USE

The products described or affected by this document, together with software, accessories, and options, are expansion modules, intended for industrial use according to the instructions, directions, examples, and safety information contained in the present document and other supporting documentation.

The product may only be used in compliance with all applicable safety regulations and directives, the specified requirements, and the technical data.

Prior to using the product, you must perform a risk assessment in view of the planned application. Based on the results, the appropriate safety-related measures must be implemented.

Since the product is used as a component in an overall machine or process, you must ensure the safety of persons by means of the design of this overall system.

Operate the product only with the specified cables and accessories. Use only genuine accessories and spare parts.

Any use other than the use explicitly permitted is prohibited and can result in unanticipated hazards.

About the Book



At a Glance

Document Scope

This guide describes the hardware implementation of TM3 Transmitter and Receiver modules. It provides the part description, characteristics, wiring diagrams, and installation details for TM3 Transmitter and Receiver modules.

Validity Note

This document has been updated for the release of TM3TI4D Add-on for SoMachine V4.3.

This document has been updated for the release of SoMachine Basic V1.6.

For product compliance and environmental information (RoHS, REACH, PEP, EOL, etc.), go to www.schneider-electric.com/green-premium.

The technical characteristics of the devices described in this document also appear online. To access this information online:

Step	Action
1	Go to the Schneider Electric home page www.schneider-electric.com .
2	In the Search box type the reference of a product or the name of a product range. <ul style="list-style-type: none">● Do not include blank spaces in the reference or product range.● To get information on grouping similar modules, use asterisks (*).
3	If you entered a reference, go to the Product Datasheets search results and click on the reference that interests you. If you entered the name of a product range, go to the Product Ranges search results and click on the product range that interests you.
4	If more than one reference appears in the Products search results, click on the reference that interests you.
5	Depending on the size of your screen, you may need to scroll down to see the data sheet.
6	To save or print a data sheet as a .pdf file, click Download XXX product datasheet .

The characteristics that are presented in this manual should be the same as those characteristics that appear online. In line with our policy of constant improvement, we may revise content over time to improve clarity and accuracy. If you see a difference between the manual and online information, use the online information as your reference.

Related Documents

Title of Documentation	Reference Number
Modicon TM3 (SoMachine Basic) Expansion Modules Configuration Programming Guide	EIO0000001396 (ENG) EIO0000001397 (FRE) EIO0000001398 (GER) EIO0000001399 (SPA) EIO0000001400 (ITA) EIO0000001401 (CHS) EIO0000001374 (POR) EIO0000001375 (TUR)
Modicon TM3 Modules Configuration Programming Guide	EIO0000001402 (ENG) EIO0000001403 (FRE) EIO0000001404 (GER) EIO0000001405 (SPA) EIO0000001406 (ITA) EIO0000001407 (CHS)
Modicon M221 Logic Controller Hardware Guide	EIO0000001384 (ENG) EIO0000001385 (FRE) EIO0000001386 (GER) EIO0000001387 (SPA) EIO0000001388 (ITA) EIO0000001389 (CHS) EIO0000001370 (POR) EIO0000001371 (TUR)
Modicon M241 Logic Controller Hardware Guide	EIO0000001456 (ENG) EIO0000001457 (FRE) EIO0000001458 (GER) EIO0000001459 (SPA) EIO0000001460 (ITA) EIO0000001461 (CHS)
Modicon M251 Logic Controller Hardware Guide	EIO0000001486 (ENG) EIO0000001487 (FRE) EIO0000001488 (GER) EIO0000001489 (SPA) EIO0000001490 (ITA) EIO0000001491 (CHS)
TM3 Transmitter and Receiver Module Instruction Sheet	HRB59607

You can download these technical publications and other technical information from our website at <http://www.schneider-electric.com/en/download>

Product Related Information

DANGER

HAZARD OF ELECTRIC SHOCK, EXPLOSION OR ARC FLASH

- Disconnect all power from all equipment including connected devices prior to removing any covers or doors, or installing or removing any accessories, hardware, cables, or wires except under the specific conditions specified in the appropriate hardware guide for this equipment.
- Always use a properly rated voltage sensing device to confirm the power is off where and when indicated.
- Replace and secure all covers, accessories, hardware, cables, and wires and confirm that a proper ground connection exists before applying power to the unit.
- Use only the specified voltage when operating this equipment and any associated products.

Failure to follow these instructions will result in death or serious injury.

DANGER

POTENTIAL FOR EXPLOSION

- Only use this equipment in non-hazardous locations, or in locations that comply with Class I, Division 2, Groups A, B, C and D.
- Do not substitute components which would impair compliance to Class I, Division 2.
- Do not connect or disconnect equipment unless power has been removed or the location is known to be non-hazardous.
- Do not use the USB port(s), if so equipped, unless the location is known to be non-hazardous.

Failure to follow these instructions will result in death or serious injury.

WARNING

LOSS OF CONTROL

- The designer of any control scheme must consider the potential failure modes of control paths and, for certain critical control functions, provide a means to achieve a safe state during and after a path failure. Examples of critical control functions are emergency stop and overtravel stop, power outage and restart.
- Separate or redundant control paths must be provided for critical control functions.
- System control paths may include communication links. Consideration must be given to the implications of unanticipated transmission delays or failures of the link.
- Observe all accident prevention regulations and local safety guidelines.¹
- Each implementation of this equipment must be individually and thoroughly tested for proper operation before being placed into service.

Failure to follow these instructions can result in death, serious injury, or equipment damage.

¹ For additional information, refer to NEMA ICS 1.1 (latest edition), "Safety Guidelines for the Application, Installation, and Maintenance of Solid State Control" and to NEMA ICS 7.1 (latest edition), "Safety Standards for Construction and Guide for Selection, Installation and Operation of Adjustable-Speed Drive Systems" or their equivalent governing your particular location.

WARNING

UNINTENDED EQUIPMENT OPERATION

- Only use software approved by Schneider Electric for use with this equipment.
- Update your application program every time you change the physical hardware configuration.

Failure to follow these instructions can result in death, serious injury, or equipment damage.

Terminology Derived from Standards

The technical terms, terminology, symbols and the corresponding descriptions in this manual, or that appear in or on the products themselves, are generally derived from the terms or definitions of international standards.

In the area of functional safety systems, drives and general automation, this may include, but is not limited to, terms such as *safety*, *safety function*, *safe state*, *fault*, *fault reset*, *malfunction*, *failure*, *error*, *error message*, *dangerous*, etc.

Among others, these standards include:

Standard	Description
EN 61131-2:2007	Programmable controllers, part 2: Equipment requirements and tests.
ISO 13849-1:2008	Safety of machinery: Safety related parts of control systems. General principles for design.

Standard	Description
EN 61496-1:2013	Safety of machinery: Electro-sensitive protective equipment. Part 1: General requirements and tests.
ISO 12100:2010	Safety of machinery - General principles for design - Risk assessment and risk reduction
EN 60204-1:2006	Safety of machinery - Electrical equipment of machines - Part 1: General requirements
EN 1088:2008 ISO 14119:2013	Safety of machinery - Interlocking devices associated with guards - Principles for design and selection
ISO 13850:2006	Safety of machinery - Emergency stop - Principles for design
EN/IEC 62061:2005	Safety of machinery - Functional safety of safety-related electrical, electronic, and electronic programmable control systems
IEC 61508-1:2010	Functional safety of electrical/electronic/programmable electronic safety-related systems: General requirements.
IEC 61508-2:2010	Functional safety of electrical/electronic/programmable electronic safety-related systems: Requirements for electrical/electronic/programmable electronic safety-related systems.
IEC 61508-3:2010	Functional safety of electrical/electronic/programmable electronic safety-related systems: Software requirements.
IEC 61784-3:2008	Digital data communication for measurement and control: Functional safety field buses.
2006/42/EC	Machinery Directive
2014/30/EU	Electromagnetic Compatibility Directive
2014/35/EU	Low Voltage Directive

In addition, terms used in the present document may tangentially be used as they are derived from other standards such as:

Standard	Description
IEC 60034 series	Rotating electrical machines
IEC 61800 series	Adjustable speed electrical power drive systems
IEC 61158 series	Digital data communications for measurement and control – Fieldbus for use in industrial control systems

Finally, the term *zone of operation* may be used in conjunction with the description of specific hazards, and is defined as it is for a *hazard zone* or *danger zone* in the *Machinery Directive (2006/42/EC)* and *ISO 12100:2010*.

NOTE: The aforementioned standards may or may not apply to the specific products cited in the present documentation. For more information concerning the individual standards applicable to the products described herein, see the characteristics tables for those product references.

Part I

TM3 General Overview

What Is in This Part?

This part contains the following chapters:

Chapter	Chapter Name	Page
1	TM3 Description	15
2	TM3 Installation	19

Chapter 1

TM3 Description

General Description

Introduction

The TM3 transmitter expansion module is equipped with:

- 1 front connector RJ45
- 1 screw for functional ground connection
- 2 status LEDs (link and power)

The TM3 receiver expansion module is equipped with:

- 1 front connector RJ45
- 1 connector for power supply
- 2 status LEDs (link and power)

The TM3 transmitter module is connected to the logic controller through the TM3 bus. It is connected using a connector at the left side of the module. The TM3 transmitter expansion module is the last physical module of the local configuration (there is no bus connector on the right-hand side of the module).

The TM3 receiver module is connected through the front connector RJ45 to the TM3 transmitter module with an appropriate cable (*see page 17*).

TM3 Transmitter and Receiver Modules

The following table shows the TM3 transmitter and receiver expansion modules:

Reference	Description	Terminal Type / Pitch
TM3XTRA1 (<i>see page 51</i>)	Data transmitter module for remote I/O	1 front connector RJ-45 1 screw for functional ground connection
TM3XREC1 (<i>see page 59</i>)	Data receiver module for remote I/O	1 front connector RJ-45 Power supply connector / 5.08 mm

Implementation of TM3 Transmitter and Receiver Modules

The following figure defines the system divided into a local configuration and remote configuration (M221 example):

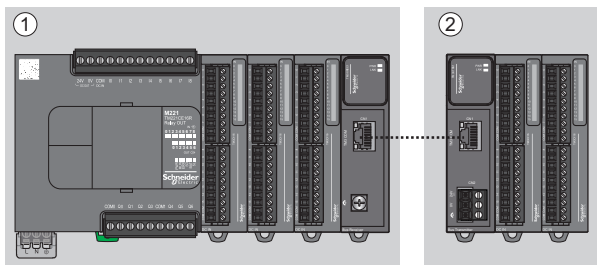

- 1 Local configuration
- 2 Remote configuration

The following figure represents the components of a remote configuration:

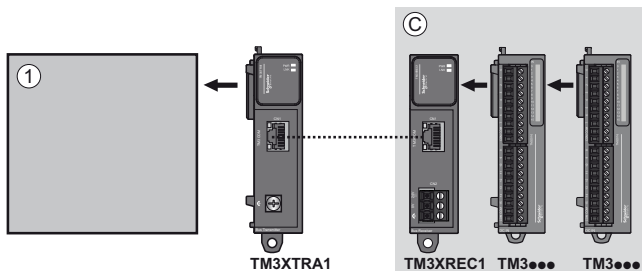

- 1 Controller and modules
- C Expansion modules (7 maximum)

NOTE: Transmitter and receiver modules does not count in the maximum number of expansion modules.

NOTE: You cannot use TM2 modules in configurations that include the TM3 transmitter and receiver modules.

Accessories

Reference	Description	Use	Quantity
TMAT2PSET	Set of 5 removable screw terminal blocks	Connects the 24 Vdc power supply.	1
AB1AB8P35	End brackets	Helps secure the logic controller or receiver module and their expansion modules on a top hat section rail (DIN rail).	1
TM2XMTGB	Grounding Bar	Connects the cable shield and the module to the functional ground.	1
TM200RSRCEMC	Shielding take-up clip	Mounts and connects the ground to the cable shielding.	25 pack
TMAM2	Mounting Kit	Mounts the controller and I/O modules directly to a flat, vertical panel.	1

Cables

Reference	Description	Use	Quantity	Length
VDIP184546005	Actassi CL-MNC5e Patchcord RJ45 cable	Connects the transmitter to the receiver.	1	0.5 m (1.64 ft)
VDIP184546010				1 m (3.28 ft)
VDIP184546020				2 m (6.56 ft)
VDIP184546030				3 m (9.84 ft)
VDIP184546050				5 m (16.40 ft)
Provided with the TM3XTRA1 module	Functional ground cable	Connect the functional ground (FE) directly to the conductive backplane.	1	0.12 m (0.39 ft)

Chapter 2

TM3 Installation

What Is in This Chapter?

This chapter contains the following sections:

Section	Topic	Page
2.1	TM3 General Rules for Implementing	20
2.2	TM3 Expansion Module Installation	25
2.3	TM3 Electrical Requirements	38

Section 2.1

TM3 General Rules for Implementing

What Is in This Section?

This section contains the following topics:

Topic	Page
Environmental Characteristics	21
Certifications and Standards	24

Environmental Characteristics

Enclosure Requirements

TM3 expansion module components are designed as Zone B, Class A industrial equipment according to IEC/CISPR Publication 11. If they are used in environments other than those described in these standards, or in environments that do not meet the specifications in this manual the ability to meet electromagnetic compatibility requirements in the presence of conducted and/or radiated interference may be reduced.

All TM3 expansion module components meet European Community (CE) requirements for open equipment as defined by IEC/EN 61131-2. You must install them in an enclosure designed for the specific environmental conditions and to minimize the possibility of unintended contact with hazardous voltages. Use metal enclosures to improve the electromagnetic immunity of your TM3 expansion module components. Use enclosures with a keyed locking mechanism to minimize unauthorized access.

Environmental Characteristics

All the TM3 expansion module components are electrically isolated between the internal electronic circuit and the input/output channels. This equipment meets CE requirements as indicated in the table below. This equipment is intended for use in a Pollution Degree 2 industrial environment.

 WARNING
UNINTENDED EQUIPMENT OPERATION
Do not exceed any of the rated values specified in the environmental and electrical characteristics tables.
Failure to follow these instructions can result in death, serious injury, or equipment damage.

The following table shows the general environmental characteristics:

Characteristic		Specification
Standard compliance	IEC/EN 61131-2 IEC/EN 61010-2-201	
Ambient operating temperature	Horizontal installation	-10...55 °C (14...131 °F)
	Vertical installation	-10...35 °C (14...95 °F)
Storage temperature	-25...70 °C (- 13...158 °F)	
Relative humidity	Transport and storage	10...95 % (non-condensing)
	Operation	10...95 % (non-condensing)
Degree of pollution	IEC/EN 60664-1	2
Degree of protection	IEC/EN 61131-2	IP20

Characteristic		Specification
Machine Safety conformance	IEC/EN 61010-2-201	Yes
Corrosion immunity		Atmosphere free from corrosive gases
Operating altitude		0...2000 m (0...6560 ft)
Storage altitude		0...3000 m (0...9843 ft)
Vibration resistance	IEC/EN 61131-2 Panel mounting or mounted on a top hat section rail (DIN rail)	3.5 mm (0.13 in) fixed amplitude from 5...8.5 Hz 29.4 m/s ² or 96.45 ft/s ² (3 g _n) fixed acceleration from 8.7...150 Hz
Mechanical shock resistance		147 m/s ² or 482.28 ft/s ² (15 g _n) for a duration of 11 ms

Electromagnetic Susceptibility

The TM3 expansion module components meets electromagnetic susceptibility specifications as indicated in the following table:

Characteristic	Designed to specification	Range		
Electrostatic discharge	IEC/EN 61000-4-2	8 kV (air discharge) 6 kV (contact discharge)		
Radiated electromagnetic field	IEC/EN 61000-4-3	10 V/m (80...1000 MHz) 3 V/m (1.4...2 GHz) 1 V/m (2...2.7 GHz)		
Magnetic field	IEC/EN 61000-4-8	30 A/m 50 Hz, 60 Hz		
Fast transients burst	IEC/EN 61000-4-4	–	CM ¹ and DM ²	
		AC/DC Power lines	1 kV	
		Communication line	1 kV	
Surge immunity	IEC/EN 61000-4-5 IEC/EN 61131-2	–	CM ¹	DM ²
		DC Power lines	1 kV	0.5 kV
		Shielded cable (between shield and ground)	1 kV	–
Induced electromagnetic field	IEC/EN 61000-4-6	10 Vrms (0.15...80 MHz)		
Conducted emission	IEC/EN 55011 (IEC/CISPR Publication 11)	AC power line:		
		<ul style="list-style-type: none"> ● 0.15...0.5 MHz: 79 dBμV/m QP / 66 dBμV/m AV ● 0.5...300 MHz: 73 dBμV/m QP / 60 dBμV/m AV 		
		AC/DC power line:		
		<ul style="list-style-type: none"> ● 10...150 kHz: 120...69 dBμV/m QP ● 150...1500 kHz: 79...63 dBμV/m QP ● 1.5...30 MHz: 63 dBμV/m QP 		

Characteristic	Designed to specification	Range
Radiated emission	IEC/EN 55011 (IEC/CISPR Publication 11)	Class A, 10 m distance: <ul style="list-style-type: none"> ● 30...230 MHz: 40 dBμV/m QP ● 230...1000 MHz: 47 dBμV/m QP
<ol style="list-style-type: none"> 1 Common Mode 2 Differential Mode 		

Certifications and Standards

Introduction

The TM3 expansion modules are designed to conform to the main national and international standards concerning electronic industrial control devices:

- IEC/EN 61131-2
- UL 508

The TM3 have obtained the following conformity marks:

- CE
- UL/CSA
- EAC
- RCM
- cCSAus Hazardous Location

For product compliance and environmental information (RoHS, REACH, PEP, EOLI, etc.), go to www.schneider-electric.com/green-premium.

Section 2.2

TM3 Expansion Module Installation

What Is in This Section?

This section contains the following topics:

Topic	Page
Installation and Maintenance Requirements	26
Installation Guidelines	29
Top Hat Section Rail (DIN rail)	30
Assembling a Module to a Controller or Receiver Module	34
Disassembling a Module from a Controller or Receiver Module	36
Direct Mounting on a Panel Surface	37

Installation and Maintenance Requirements

Before Starting

Read and understand this chapter before beginning the installation of your system.

The use and application of the information contained herein require expertise in the design and programming of automated control systems. Only you, the user, machine builder or integrator, can be aware of all the conditions and factors present during installation and setup, operation, and maintenance of the machine or process, and can therefore determine the automation and associated equipment and the related safeties and interlocks which can be effectively and properly used. When selecting automation and control equipment, and any other related equipment or software, for a particular application, you must also consider any applicable local, regional or national standards and/or regulations.

Pay particular attention in conforming to any safety information, different electrical requirements, and normative standards that would apply to your machine or process in the use of this equipment.

Disconnecting Power

All options and modules should be assembled and installed before installing the control system on a mounting rail, onto a mounting plate or in a panel. Remove the control system from its mounting rail, mounting plate or panel before disassembling the equipment.

DANGER

HAZARD OF ELECTRIC SHOCK, EXPLOSION OR ARC FLASH

- Disconnect all power from all equipment including connected devices prior to removing any covers or doors, or installing or removing any accessories, hardware, cables, or wires except under the specific conditions specified in the appropriate hardware guide for this equipment.
- Always use a properly rated voltage sensing device to confirm the power is off where and when indicated.
- Replace and secure all covers, accessories, hardware, cables, and wires and confirm that a proper ground connection exists before applying power to the unit.
- Use only the specified voltage when operating this equipment and any associated products.

Failure to follow these instructions will result in death or serious injury.

Programming Considerations

WARNING

UNINTENDED EQUIPMENT OPERATION

- Only use software approved by Schneider Electric for use with this equipment.
- Update your application program every time you change the physical hardware configuration.

Failure to follow these instructions can result in death, serious injury, or equipment damage.

Operating Environment

In addition to the **Environmental Characteristics**, refer to **Product Related Information** in the beginning of the present document for important information regarding installation in hazardous locations for this specific equipment.

WARNING

UNINTENDED EQUIPMENT OPERATION

Install and operate this equipment according to the conditions described in the Environmental Characteristics.

Failure to follow these instructions can result in death, serious injury, or equipment damage.

Installation Considerations

WARNING

UNINTENDED EQUIPMENT OPERATION

- Use appropriate safety interlocks where personnel and/or equipment hazards exist.
- Install and operate this equipment in an enclosure appropriately rated for its intended environment and secured by a keyed or tooled locking mechanism.
- Use the sensor and actuator power supplies only for supplying power to the sensors or actuators connected to the module.
- Power line and output circuits must be wired and fused in compliance with local and national regulatory requirements for the rated current and voltage of the particular equipment.
- Do not use this equipment in safety-critical machine functions unless the equipment is otherwise designated as functional safety equipment and conforming to applicable regulations and standards.
- Do not disassemble, repair, or modify this equipment.
- Do not connect any wiring to reserved, unused connections, or to connections designated as No Connection (N.C.).

Failure to follow these instructions can result in death, serious injury, or equipment damage.

NOTE: JDYX2 or JDYX8 fuse types are UL-recognized and CSA approved.

Installation Guidelines

Introduction

TM3 expansion modules are assembled by connecting them to a logic controller or receiver module.

The logic controller or receiver module and their expansion modules can be installed on a top hat section rail (DIN rail).

Mounting Position and Minimum Clearances

The mounting position and minimum clearances of the expansion modules must conform with the rules defined for the appropriate hardware system. Refer to the *Installation chapter* in the *Controller Hardware* documentation for your specific controller.

WARNING

UNINTENDED EQUIPMENT OPERATION

- Place devices dissipating the most heat at the top of the cabinet and ensure adequate ventilation.
- Avoid placing this equipment next to or above devices that might cause overheating.
- Install the equipment in a location providing the minimum clearances from all adjacent structures and equipment as directed in this document.
- Install all equipment in accordance with the specifications in the related documentation.

Failure to follow these instructions can result in death, serious injury, or equipment damage.

Top Hat Section Rail (DIN rail)

Dimensions of Top Hat Section Rail DIN Rail

You can mount the controller or receiver and its expansions on a 35 mm (1.38 in.) top hat section rail (DIN rail). It can be attached to a smooth mounting surface or suspended from a EIA rack or mounted in a NEMA cabinet.

Symmetric Top Hat Section Rails (DIN Rail)

The following illustration and table show the references of the top hat section rails (DIN rail) for the wall-mounting range:

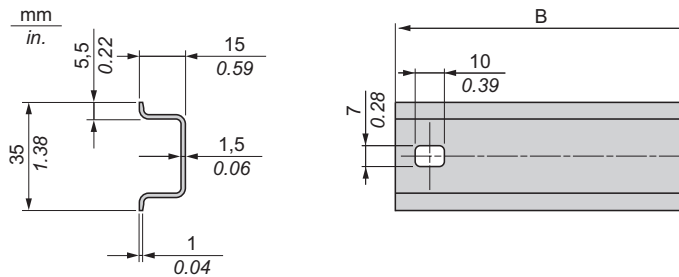

Reference	Type	Rail Length (B)
NSYSDR50A	A	450 mm (17.71 in.)
NSYSDR60A	A	550 mm (21.65 in.)
NSYSDR80A	A	750 mm (29.52 in.)
NSYSDR100A	A	950 mm (37.40 in.)

The following illustration and table show the references of the symmetric top hat section rails (DIN rail) for the metal enclosure range:

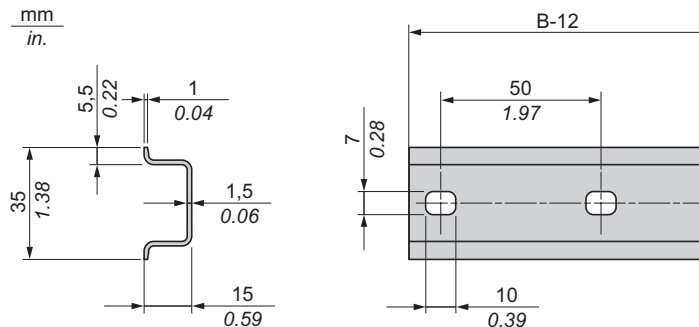

Reference	Type	Rail Length (B-12 mm)
NSYSDR60	A	588 mm (23.15 in.)
NSYSDR80	A	788 mm (31.02 in.)
NSYSDR100	A	988 mm (38.89 in.)
NSYSDR120	A	1188 mm (46.77 in.)

The following illustration and table shows the references of the symmetric top hat section rails (DIN rail) of 2000 mm (78.74 in.):

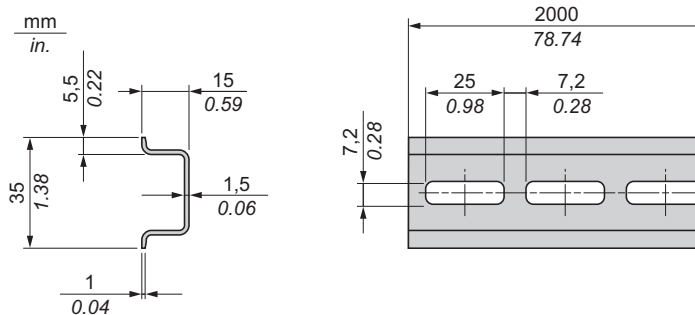

Reference	Type	Rail Length
NSYSDR200 ¹	A	2000 mm (78.74 in.)
NSYSDR200D ²	A	
1 Unperforated galvanized steel 2 Perforated galvanized steel		

Double-Profile Top Hat Section Rails (DIN rail)

The following illustration and table show the references of the double-profile top hat section rails (DIN rails) for the wall-mounting range:

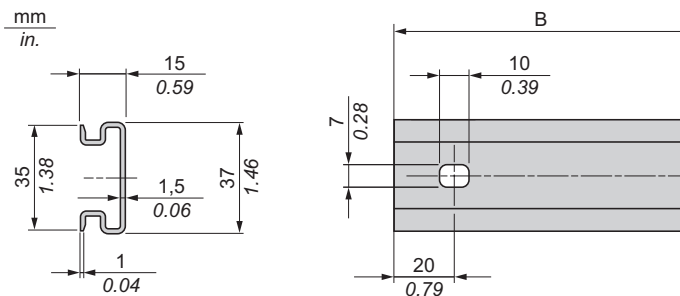

Reference	Type	Rail Length (B)
NSYDPR25	W	250 mm (9.84 in.)
NSYDPR35	W	350 mm (13.77 in.)
NSYDPR45	W	450 mm (17.71 in.)
NSYDPR55	W	550 mm (21.65 in.)
NSYDPR65	W	650 mm (25.60 in.)
NSYDPR75	W	750 mm (29.52 in.)

The following illustration and table show the references of the double-profile top hat section rails (DIN rail) for the floor-standing range:

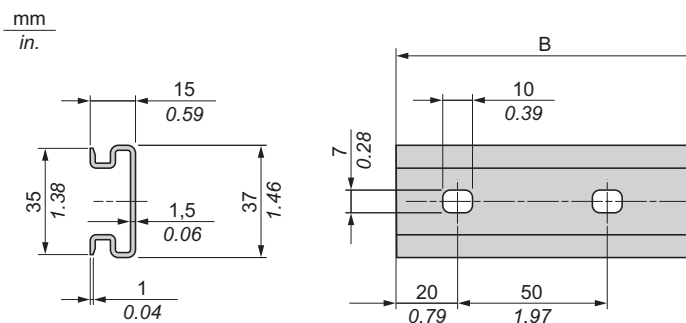

Reference	Type	Rail Length (B)
NSYDPR60	F	588 mm (23.15 in.)
NSYDPR80	F	788 mm (31.02 in.)
NSYDPR100	F	988 mm (38.89 in.)
NSYDPR120	F	1188 mm (46.77 in.)

Assembling a Module to a Controller or Receiver Module

Introduction

This section describes how to assemble an expansion module to a controller, Receiver module or other modules.

DANGER

HAZARD OF ELECTRIC SHOCK, EXPLOSION OR ARC FLASH

- Disconnect all power from all equipment including connected devices prior to removing any covers or doors, or installing or removing any accessories, hardware, cables, or wires except under the specific conditions specified in the appropriate hardware guide for this equipment.
- Always use a properly rated voltage sensing device to confirm the power is off where and when indicated.
- Replace and secure all covers, accessories, hardware, cables, and wires and confirm that a proper ground connection exists before applying power to the unit.
- Use only the specified voltage when operating this equipment and any associated products.

Failure to follow these instructions will result in death or serious injury.

After connecting new modules to the controller, either directly or through a transmitter/receiver, update and reupload your application program before placing the system back in service. If you do not revise your application program to reflect the addition of new modules, I/O located on the expansion bus may no longer operate normally.

WARNING

UNINTENDED EQUIPMENT OPERATION

- Only use software approved by Schneider Electric for use with this equipment.
- Update your application program every time you change the physical hardware configuration.

Failure to follow these instructions can result in death, serious injury, or equipment damage.

Assembling a Module to a Controller or Receiver Module

The following procedure shows how to assemble a controller or receiver module and a module together.

Step	Action
1	Remove all power and dismount any existing controller I/O assembly from its DIN mounting.
2	Remove the expansion connector sticker from the controller or the outermost installed expansion module.
3	Verify that the locking device (<i>see page 52</i>) on the new module is in the upper position.
4	Align the internal bus connector on the left side of the module with the internal bus connector on the right side of the controller, Receiver module or expansion module.
5	Press the new module towards the controller, Receiver module or expansion module until it is securely in place.
6	Push down the locking device (<i>see page 52</i>) on the top of the new module to lock it to the controller, Receiver module or previously installed expansion module.

Disassembling a Module from a Controller or Receiver Module

Introduction

This section describes how to disassemble a module from a controller or receiver module.

DANGER

HAZARD OF ELECTRIC SHOCK, EXPLOSION OR ARC FLASH

- Disconnect all power from all equipment including connected devices prior to removing any covers or doors, or installing or removing any accessories, hardware, cables, or wires except under the specific conditions specified in the appropriate hardware guide for this equipment.
- Always use a properly rated voltage sensing device to confirm the power is off where and when indicated.
- Replace and secure all covers, accessories, hardware, cables, and wires and confirm that a proper ground connection exists before applying power to the unit.
- Use only the specified voltage when operating this equipment and any associated products.

Failure to follow these instructions will result in death or serious injury.

Disassembling a Module from a Controller or Receiver Module

The following procedure describes how to disassemble a module from a controller or receiver module.

Step	Action
1	Remove all power from the control system.
2	Dismount the assembled controller and modules from the mounting rail.
3	Push up the locking device from the bottom of the module to disengage it from the controller or receiver module.
4	Pull apart module from the controller or receiver module.

Direct Mounting on a Panel Surface

Overview

This section shows how to install TM3 expansion module using the Panel Mounting Kit. This section also provides mounting hole layout for all modules.

Installing the Panel Mount Kit

The following procedure shows how to install a mounting strip:

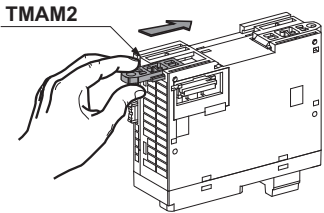
Step	Action
1	<p>Insert the mounting strip TMAM2 into the slot at the top of the module.</p> 

Mounting Hole Layout

The following diagram shows the mounting holes for TM3XTRA1 and TM3XREC1 expansion modules:

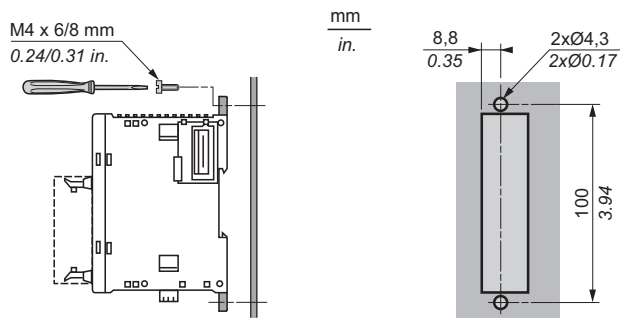

Section 2.3

TM3 Electrical Requirements

What Is in This Section?

This section contains the following topics:

Topic	Page
Wiring Best Practices	39
Grounding the TM3 System	43

Wiring Best Practices

Overview

This section describes the wiring guidelines and associated best practices to be respected when using the TM3 system.

DANGER

HAZARD OF ELECTRIC SHOCK, EXPLOSION OR ARC FLASH

- Disconnect all power from all equipment including connected devices prior to removing any covers or doors, or installing or removing any accessories, hardware, cables, or wires except under the specific conditions specified in the appropriate hardware guide for this equipment.
- Always use a properly rated voltage sensing device to confirm the power is off where and when indicated.
- Replace and secure all covers, accessories, hardware, cables, and wires and confirm that a proper ground connection exists before applying power to the unit.
- Use only the specified voltage when operating this equipment and any associated products.

Failure to follow these instructions will result in death or serious injury.

WARNING

LOSS OF CONTROL

- The designer of any control scheme must consider the potential failure modes of control paths and, for certain critical control functions, provide a means to achieve a safe state during and after a path failure. Examples of critical control functions are emergency stop and overtravel stop, power outage and restart.
- Separate or redundant control paths must be provided for critical control functions.
- System control paths may include communication links. Consideration must be given to the implications of unanticipated transmission delays or failures of the link.
- Observe all accident prevention regulations and local safety guidelines.¹
- Each implementation of this equipment must be individually and thoroughly tested for proper operation before being placed into service.

Failure to follow these instructions can result in death, serious injury, or equipment damage.

¹ For additional information, refer to NEMA ICS 1.1 (latest edition), "Safety Guidelines for the Application, Installation, and Maintenance of Solid State Control" and to NEMA ICS 7.1 (latest edition), "Safety Standards for Construction and Guide for Selection, Installation and Operation of Adjustable-Speed Drive Systems" or their equivalent governing your particular location.

Functional Ground (FE) on the DIN Rail

The DIN Rail for your TM3 system is common with the functional ground (FE) plane and must be mounted on a conductive backplane.

WARNING

UNINTENDED EQUIPMENT OPERATION

Connect the DIN rail to the functional ground (FE) of your installation.

Failure to follow these instructions can result in death, serious injury, or equipment damage.

Protective Ground (PE) on the Backplane

The protective ground (PE) is connected to the conductive backplane by a heavy-duty wire, usually a braided copper cable with the maximum allowable cable section.

Wiring Guidelines

The following rules must be applied when wiring a TM3 system:

- I/O and communication wiring must be kept separate from the power wiring. Route these 2 types of wiring in separate cable ducting.
- Verify that the operating conditions and environment are within the specification values.
- Use proper wire sizes to meet voltage and current requirements.
- Use copper conductors.
- Use twisted-pair, shielded cables for analog, and/or fast I/O.
- Use twisted-pair, shielded cables for networks, and field bus.

WARNING

UNINTENDED EQUIPMENT OPERATION

- Use shielded cables for all fast I/O, analog I/O, and communication signals.
- Ground cable shields for all fast I/O, analog I/O, and communication signals at a single point¹.
- Route communications and I/O cables separately from power cables.









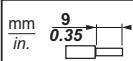

Failure to follow these instructions can result in death, serious injury, or equipment damage.

¹Multipoint grounding is permissible if connections are made to an equipotential ground plane dimensioned to help avoid cable shield damage in the event of power system short-circuit currents.









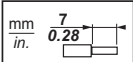

NOTE: Surface temperatures may exceed 60 °C (140 °F). To conform to IEC 61010 standards, route primary wiring (wires connected to power mains) separately and apart from secondary wiring (extra low voltage wiring coming from intervening power sources). If that is not possible, double insulation is required such as conduit or cable gains.

Rules for Removable Screw Terminal Block

The following tables show the cable types and wire sizes for a **3.81 pitch** removable screw terminal block (I/Os and power supply):

								
mm ²	0.14...1.5	0.14...1.5	0.25...1.5	0.25...0.5	2 x 0.14...0.5	2 x 0.14...0.75	2 x 0.25...0.34	2 x 0.5
AWG	26...16	26...16	22...16	22...20	2 x 26...20	2 x 26...20	2 x 24...22	2 x 20
 Ø 2,5 mm (0.1 in.)				N•m	0.28			
				lb-in	2.48			

The following tables show the cable types and wire sizes for a **5.08 pitch** removable screw terminal block (I/Os and power supply):

								
mm ²	0.2...2.5	0.2...2.5	0.25...2.5	0.25...2.5	2 x 0.2...1	2 x 0.2...1.5	2 x 0.25...1	2 x 0.5...1.5
AWG	24...14	24...14	23...14	23...14	2 x 24...17	2 x 24...16	2 x 23...17	2 x 20...16
 Ø 3,5 mm (0.14 in.)				N•m	0.49			
				lb-in	4.34			

The use of copper conductors is required.

⚠ DANGER





FIRE HAZARD

- Use only the correct wire sizes for the current capacity of the I/O channels and power supplies.
- For relay output (2 A) wiring, use conductors of at least 0.5 mm² (AWG 20) with a temperature rating of at least 80 °C (176 °F).
- For common conductors of relay output wiring (7 A), or relay output wiring greater than 2 A, use conductors of at least 1.0 mm² (AWG 16) with a temperature rating of at least 80 °C (176 °F).



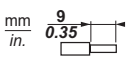



Failure to follow these instructions will result in death or serious injury.

Rules for Removable Spring Terminal Block

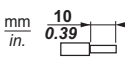
The following tables show the cable types and wire sizes for a **3.81 pitch** removable spring terminal block (I/Os and power supply):

				
mm ²	0.2...1.5	0.2...1.5	0.25...1.0	0.25...0.5
AWG	24...16	24...16	23...18	23...21

The following tables show the cable types and wire sizes for a **5.08 pitch** removable spring terminal block (I/Os and power supply):

					
mm ²	0.2...2.5	0.2...2.5	0.25...2.5	0.25...2.5	2 x 0.5...1
AWG	24...14	24...14	23...14	23...14	2 x 20...17

The use of copper conductors is required.

⚠ DANGER

FIRE HAZARD

- Use only the correct wire sizes for the current capacity of the I/O channels and power supplies.
- For relay output (2 A) wiring, use conductors of at least 0.5 mm² (AWG 20) with a temperature rating of at least 80 °C (176 °F).
- For common conductors of relay output wiring (7 A), or relay output wiring greater than 2 A, use conductors of at least 1.0 mm² (AWG 16) with a temperature rating of at least 80 °C (176 °F).

Failure to follow these instructions will result in death or serious injury.

The spring clamp connectors of the terminal block are designed for only one wire or one cable end. Two wires to the same connector must be installed with a double wire cable end to help prevent loosening.

⚡ ⚠ DANGER

LOOSE WIRING CAUSES ELECTRIC SHOCK

Do not insert more than one wire per connector of the terminal block unless using a double wire cable end (ferrule).

Failure to follow these instructions will result in death or serious injury.

Grounding the TM3 System

Overview

The effects of electromagnetic interference, cables carrying fast I/O, analog I/O, and the fieldbus communication signals must be shielded.

WARNING

UNINTENDED EQUIPMENT OPERATION

- Use shielded cables for all fast I/O, analog I/O, and communication signals.
- Ground cable shields for all fast I/O, analog I/O, and communication signals at a single point¹.
- Route communications and I/O cables separately from power cables.

Failure to follow these instructions can result in death, serious injury, or equipment damage.

¹Multipoint grounding is permissible if connections are made to an equipotential ground plane dimensioned to help avoid cable shield damage in the event of power system short-circuit currents.

The use of shielded cables requires compliance with the following wiring rules:

- For protective earth ground connections (PE), metal conduit or ducting can be used for part of the shielding length, provided there is no break in the continuity of the ground connections. For functional ground (FE), the shielding is intended to attenuate electromagnetic interference and the shielding must be continuous for the length of the cable. If the purpose is both functional and protective, as is often the case for communication cables, the cable must have continuous shielding.
- Wherever possible, keep cables carrying one type of signal separate from the cables carrying other types of signals or power.

Protective Earth Ground (PE) on the Backplane

The protective earth ground (PE) is connected to the conductive backplane by a heavy-duty wire, usually a braided copper cable with the maximum allowable cable section.

Shielded Cables Connections

Cables carrying fast I/O, analog I/O, and the fieldbus communication signals must be shielded. The shielding must be securely connected to ground. Fast I/O and analog I/O shields may be connected either to the functional ground (FE) or to the protective earth ground (PE) of your TM3 expansion module. The fieldbus communication cable shields must be connected to the protective earth ground (PE) with a connecting clamp secured to the conductive backplane of your installation.

⚠ WARNING

ACCIDENTAL DISCONNECTION FROM PROTECTIVE GROUND (PE)

- Do not use the TM2XMTGB Grounding Bar to provide a protective earth ground (PE).
- Use the TM2XMTGB Grounding Bar only to provide a functional ground (FE).

Failure to follow these instructions can result in death, serious injury, or equipment damage.

Functional Ground (FE) Connections

To connect the functional ground (FE):

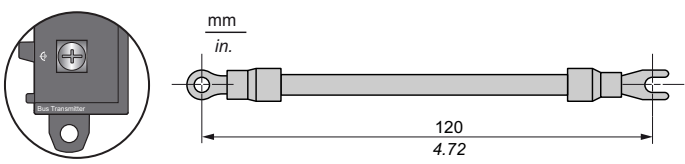
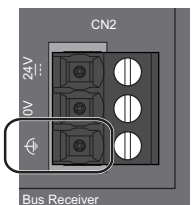
Step	Description
1	<p>Connect the functional ground cable from the TM3XTRA1 functional ground screw to the conductive backplane.</p> 
2	<p>Connect the functional ground of the TM3XREC1 power supply connector to the conductive backplane. The functional ground cable requires a cross-section of at least 1.5 mm² (AWG 16) and a maximum length of 120 mm (4.72 in.).</p> 

This figure presents grounding with a common ground plane:

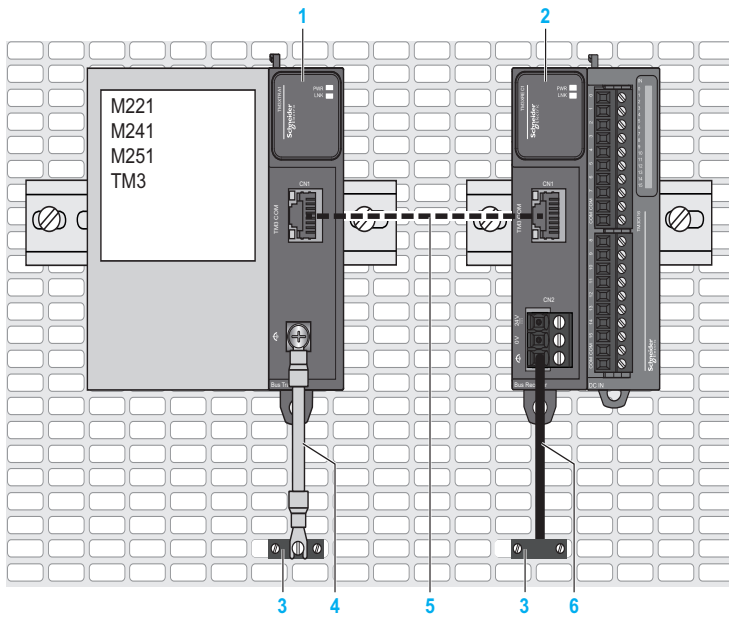

- (1) TM3XTRA1
- (2) TM3XREC1
- (3) Functional ground (FE)
- (4) Provided functional ground cable
- (5) VDIP1845460**
- (6) User-supplied grounding cable

This figure presents grounding with separated ground planes:

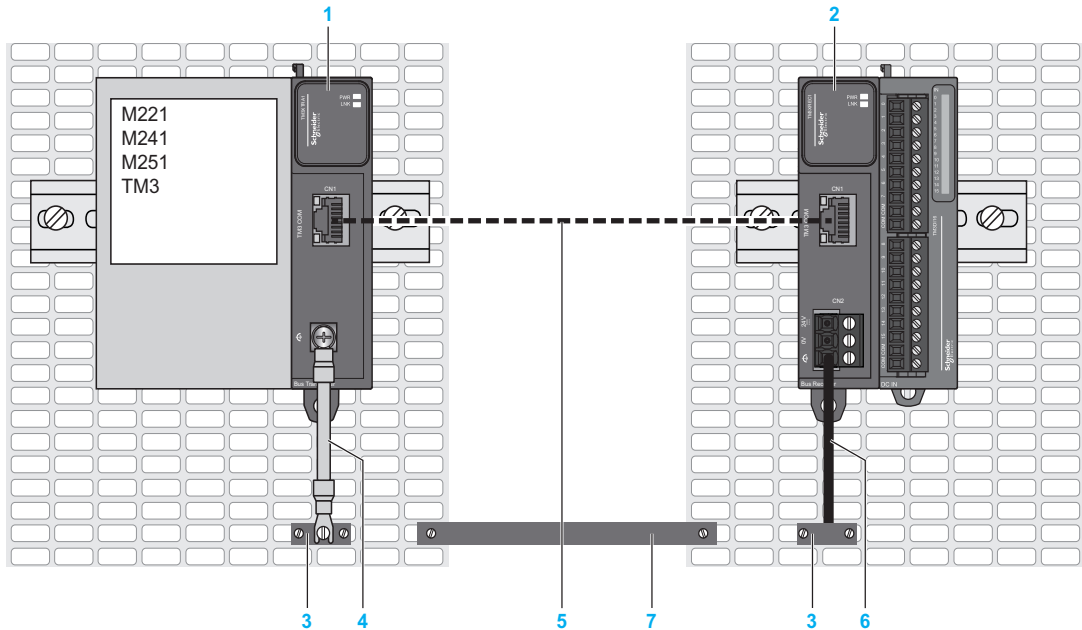

- (1) TM3XTRA1
- (2) TM3XREC1
- (3) Functional ground (FE)
- (4) Provided functional ground cable
- (5) VDIP1845460••
- (6) User-supplied grounding cable
- (7) Equipotential ground connection

Part II

TM3 Transmitter and Receiver Modules

What Is in This Part?

This part contains the following chapters:

Chapter	Chapter Name	Page
3	Compatibility	49
4	TM3XTRA1 Transmitter Module	51
5	TM3XREC1 Receiver Module	59

Chapter 3

Compatibility

Compatibility of the TM3 Transmitter and Receiver Modules

Overview

The TM3 Transmitter and Receiver modules require that the controllers contain compatible firmware in order to operate correctly.

The TM3 Transmitter and Receiver modules may initially appear to function with versions of control firmware inferior to the compatible versions. However, there is a risk that the TM3 Transmitter and Receiver modules operates incorrectly such that I/O modules cause perturbations to the proper functioning of the TM3 I/O bus, indications of spurious I/O module error states, or otherwise operate other than intended.

Compatibility with the M221 Logic Controller (SoMachine Basic)

WARNING

UNINTENDED EQUIPMENT OPERATION

- Verify that the version of firmware in your controller is version 1.1.1.2 or greater.
- Upgrade your controller to version 1.1.1.2 or greater in the event that it contains an inferior version of firmware.

Failure to follow these instructions can result in death, serious injury, or equipment damage.

You can find firmware versions compatible with the TM3 Transmitter and Receiver modules on the Schneider Electric website. Follow the instructions below to download the proper files:

Step	Action
1	Go to http://www.schneider-electric.com/
2	In the Search box, type "M221 firmware".
3	In the search results page, select Sort by: By date .
4	Click the version associated with the SoMachine Basic version you use. Result: A window appears allowing you to download the chosen file.
5	Once downloaded to your PC, open the compressed file and follow the instructions contained in the Readme document to install the firmware.

Compatibility with the M241/M251 Logic Controllers (SoMachine)

 WARNING
UNINTENDED EQUIPMENT OPERATION
<ul style="list-style-type: none"> • Verify that the version of firmware in your M241/M251 logic controller is version 4.0.2.12 or greater. • Upgrade your controller to version 4.0.2.12 or greater in the event that it contains an inferior version of firmware.
Failure to follow these instructions can result in death, serious injury, or equipment damage.

You can find firmware versions compatible with the TM3 Transmitter and Receiver modules on the Schneider Electric website. Follow the instructions below to download the proper files:

Step	Action
1	Go to http://www.schneider-electric.com/
2	In the Search box, type "M241 firmware" or "M251 firmware".
3	In the search results, click the firmware version you require. Result: A window appears allowing you to download the chosen file.
4	Once downloaded to your PC, open the compressed file and follow the instructions contained in the Readme document to install the firmware.

Chapter 4

TM3XTRA1 Transmitter Module

Overview

This chapter describes the TM3XTRA1 expansion module, its characteristics, and its connection to the different sensors.

What Is in This Chapter?

This chapter contains the following topics:

Topic	Page
TM3XTRA1 Presentation	52
TM3XTRA1 Characteristics	54
TM3XTRA1 Wiring Diagram	56

TM3XTRA1 Presentation

Overview

Transmitter module:

- One RJ45 connector for communication
- Screw for functional ground connection

Description

The following figures show the parts of the TM3 transmitter expansion module:

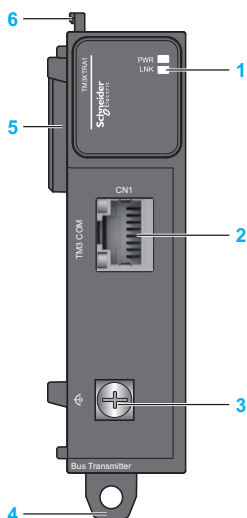

Label	Elements	Refer to
1	LEDs for displaying the link activity and power supply status.	–
2	TM3 bus port	–
3	Screw for functional ground connection	Wiring Requirement (see page 43)
4	Clip-on lock for 35 mm (1.38 in.) DIN-rail	The DIN rail (see page 30)
5	Expansion connector for I/O bus (left side only).	–
6	Locking device for attachment to the previous module	–

NOTE: The transmitter must be the last module in the local I/O expansion configuration.

Status LEDs

The following figure shows the status LEDs:



This table describes the status LEDs:

LED	Color	Status	Description
Power (PWR)	Green	On	Power supply from TM3 bus is available.
		Off	Power supply from TM3 bus is not available.
Link (LNK)	Green	On	Link/data signal is detected from the receiver.
		Off	No link/data signal is detected from the receiver.

TM3XTRA1 Characteristics

Introduction

This section provides a description of the characteristics of the TM3XTRA1 expansion module. See also Environmental Characteristics (*see page 21*).

⚠ WARNING
UNINTENDED EQUIPMENT OPERATION
Do not exceed any of the rated values specified in the environmental and electrical characteristics tables.
Failure to follow these instructions can result in death, serious injury, or equipment damage.

Dimensions

The following diagrams show the dimensions for the TM3XTRA1 expansion module:

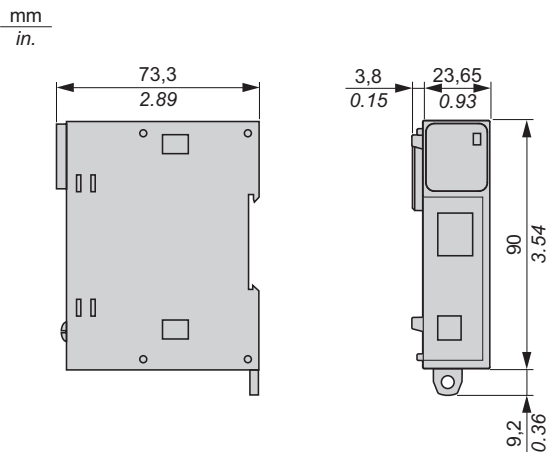

Main Characteristics

Characteristics	Value
Function	Associated with the receiver forms the remote I/O expansion.
Connector type	RJ45
Communication type	RS485
Current draw on 5 Vdc internal bus	160 mA maximum
Current draw on 24 Vdc internal bus	–
Cable type and length	For more information, refer to VDIP1845460** <i>(see page 17).</i>
Weight	65 g (2.29 oz)

TM3XTRA1 Wiring Diagram

Wiring Rules

See Wiring Best Practices (*see page 39*).

TM3 Bus Port

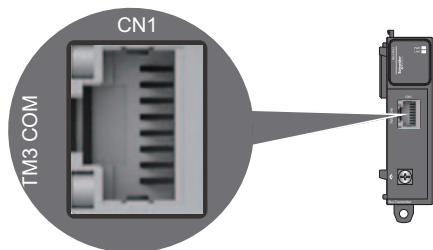

The TM3XTRA1 is equipped with an RJ45 connector.

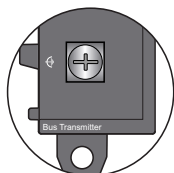

Rules for Connection to the Functional Ground

The following table shows the characteristics of the screw to be used with the provided Functional Ground (FE) Cable (*see page 44*):



 Phillips Ph2		N•m	0.5
		lb-in	4.4

Applying torque above the limit may damage the terminal screw or threads.

NOTICE

INOPERABLE EQUIPMENT

Do not tighten screw terminals beyond the specified maximum torque (Nm / lb-in.).

Failure to follow these instructions can result in equipment damage.

NOTE: You must connect the functional ground (FE) of the TM3 transmitter module to the same functional ground connected to your controller. Without the functional ground connection, the TM3 transmitter module may not establish communication with the TM3 receiver module.

NOTICE

INOPERABLE EQUIPMENT

- Ensure that the functional ground cable is securely connected between the functional ground screw of the TM3 transmitter module and the functional ground of the controller.
- Monitor the status of the TM3 bus within your application to determine the correct behavior of the TM3 bus in case of disconnection from the functional ground of the TM3 transmitter module.

Failure to follow these instructions can result in equipment damage.

Chapter 5

TM3XREC1 Receiver Module

Overview

This chapter describes the TM3XREC1 expansion module, its characteristics, and its connection to the different sensors.

What Is in This Chapter?

This chapter contains the following topics:

Topic	Page
TM3XREC1 Presentation	60
TM3XREC1 Characteristics	62
TM3XREC1 Wiring Diagram	64

TM3XREC1 Presentation

Overview

Receiver module:

- One RJ45 connector for communication
- Removable 24 Vdc power supply terminal block

Description

The following figures show the parts of the TM3 receiver expansion module:

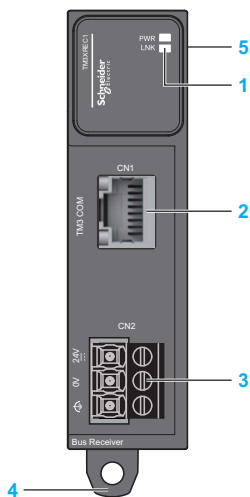

Label	Elements	Refer to
1	LEDs for displaying the link activity and power supply status.	–
2	TM3 bus port	–
3	Power supply screw terminal block.	Power Supply Wiring diagram (<i>see page 64</i>)
4	Clip-on lock for 35 mm (1.38 in.) DIN-rail.	The DIN rail (<i>see page 30</i>)
5	Expansion connector for I/O bus (right side only).	–

Status LEDs

The following figure shows the status LEDs:



This table describes the status LEDs:

LED	Color	Status	Description
Power (PWR)	Green	On	Power supply for TM3 bus is available.
		Off	Power supply for TM3 bus is not available.
Link (LNK)	Green	On	Link/data signal is detected from the transmitter.
		Off	No link/data signal is detected from the transmitter.

TM3XREC1 Characteristics

Introduction

This section provides a description of the characteristics of the TM3XREC1 module.

See also Environmental Characteristics (*see page 21*).

DANGER

FIRE HAZARD

- Use only the correct wire sizes for the current capacity of the I/O channels and power supplies.
- For relay output (2 A) wiring, use conductors of at least 0.5 mm² (AWG 20) with a temperature rating of at least 80 °C (176 °F).
- For common conductors of relay output wiring (7 A), or relay output wiring greater than 2 A, use conductors of at least 1.0 mm² (AWG 16) with a temperature rating of at least 80 °C (176 °F).

Failure to follow these instructions will result in death or serious injury.

WARNING

UNINTENDED EQUIPMENT OPERATION

Do not exceed any of the rated values specified in the environmental and electrical characteristics tables.

Failure to follow these instructions can result in death, serious injury, or equipment damage.

Dimensions

The following diagrams show the dimensions for the TM3XREC1 expansion module:

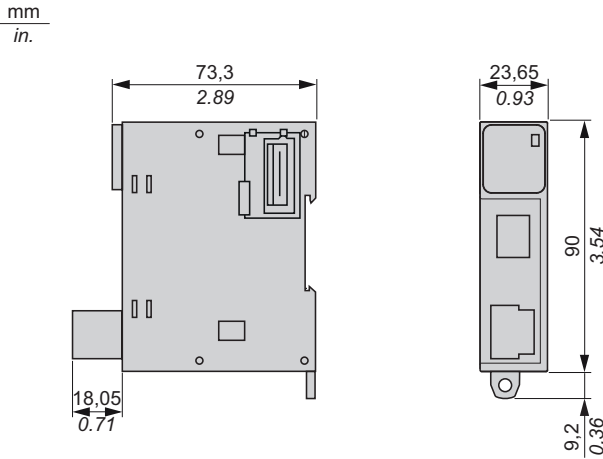

Main Characteristics

Characteristics		Value
Function		Associated with the transmitter forms the remote I/O expansion.
Connector type		RJ45
Communication type		RS485
Power dissipation		1W max.
Receiver module	Current draw on 24 Vdc power supply for the receiver module	40 mA
	The current consumption on 24 Vdc power supply for the internal bus	1A max. (with the max. number of TM3 expansion modules).
Power supplied available for connected inputs and outputs modules.	Current draw on 5 Vdc internal bus	560 mA max.
	Current draw on 24 Vdc internal bus	560 mA max.
Cable type and length		For more information, refer to Cables (see page 17).
Weight		75 g (2.64 oz)

TM3XREC1 Wiring Diagram

Wiring Rules

See Wiring Best Practices (*see page 39*).

TM3 Bus Port

The TM3XREC1 is equipped with an RJ45 connector.

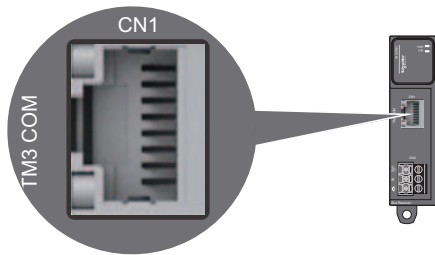

DC Power Supply Wiring Diagram

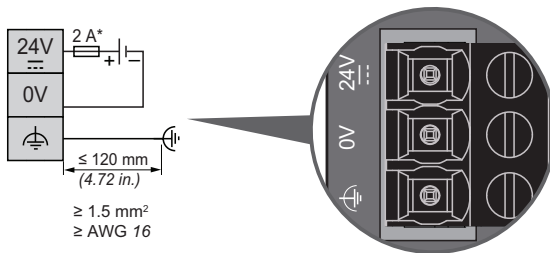

* type T fuse

The functional ground cable requires a cross-section of at least 1.5 mm^2 (AWG 16) and a maximum length of 120 mm (4.72 in.).

The controller and associated I/O (TM3 and receiver modules) require power supplies with a nominal voltage of 24 Vdc. The 24 Vdc power supplies must be rated Safety Extra Low Voltage (SELV) or Protective Extra Low Voltage (PELV) according to IEC 61140. These power supplies are isolated between the electrical input and output circuits of the power supply.

WARNING

POTENTIAL OF OVERHEATING AND FIRE

- Do not connect the equipment directly to line voltage.
- Use only isolating PELV or SELV power supplies to supply power to the equipment¹.

Failure to follow these instructions can result in death, serious injury, or equipment damage.

¹For compliance to UL (Underwriters Laboratories) requirements, the power supply must also be of a type Class 2 with a maximum power output availability of less than 100 VA (approximately 4 A at nominal voltage). A Class 2 circuit requires dry indoor use only in non-hazardous locations, and must be grounded. You must separate Class 2 circuits from other circuits. If a non-Class 2 power source is used, either power supply or transformer, you must impose a current limiting device such as a fuse or a circuit breaker with a maximum rating of 4 A, but never exceeding the limits indicated in the electric characteristics and wiring diagrams for this equipment. If the indicated rating of the electrical characteristics or wiring diagrams are greater than 4 A, multiple Class 2 power supplies may be used.

DC Power Supply Rules

If 2 separate power supplies are used for the receiver and the controller, the TM3 receiver module power supply must be switched on before the controller power supply. If not, the TM3 bus does not start, and all modules are in Reset state (all outputs are forced to 0).

When the TM3 receiver module and the controller are supplied by the same power supply, the whole configuration starts together properly.

If only the TM3 receiver module is powered (controller not supplied), the TM3 modules after the TM3 receiver module are in Reset state (all outputs are forced to 0).

NOTE: You must connect the functional ground (FE) via the power supply, and the functional or protective ground of the power supply to the same equipotential functional ground of the controller and TM3 transmitter module. Without the functional ground connection, the TM3 transmitter module may not establish communication with the TM3 receiver module, or possibly damage your equipment.

NOTICE

INOPERABLE EQUIPMENT

- Ensure that the functional ground power supply connection of the TM3 receiver module is securely connected to the functional ground of the controller system.
- Monitor the status of the TM3 bus within your application to determine the correct behavior of TM3 bus in case of disconnection from the functional ground.

Failure to follow these instructions can result in equipment damage.

Glossary



A

application

A program including configuration data, symbols, and documentation.

C

configuration

The arrangement and interconnection of hardware components within a system and the hardware and software parameters that determine the operating characteristics of the system.

controller

Automates industrial processes (also known as programmable logic controller or programmable controller).

E

EIA rack

(*electronic industries alliance rack*) A standardized (EIA 310-D, IEC 60297, and DIN 41494 SC48D) system for mounting various electronic modules in a stack or rack that is 19 inches (482.6 mm) wide.

EN

EN identifies one of many European standards maintained by CEN (*European Committee for Standardization*), CENELEC (*European Committee for Electrotechnical Standardization*), or ETSI (*European Telecommunications Standards Institute*).

expansion bus

An electronic communication bus between expansion I/O modules and a controller.

expansion connector

A connector to attach expansion I/O modules.

H

HE10

Rectangular connector for electrical signals with frequencies below 3 MHz, complying with IEC 60807-2.

I

I/O

(*input/output*)

IEC

(*international electrotechnical commission*) A non-profit and non-governmental international standards organization that prepares and publishes international standards for electrical, electronic, and related technologies.

IP 20

(*ingress protection*) The protection classification according to IEC 60529 offered by an enclosure, shown by the letter IP and 2 digits. The first digit indicates 2 factors: helping protect persons and for equipment. The second digit indicates helping protect against water. IP 20 devices help protect against electric contact of objects larger than 12.5 mm, but not against water.

N

NEMA

(*national electrical manufacturers association*) The standard for the performance of various classes of electrical enclosures. The NEMA standards cover corrosion resistance, ability to help protect from rain, submersion, and so on. For IEC member countries, the IEC 60529 standard classifies the ingress protection rating for enclosures.

P

PE

(*Protective Earth*) A common grounding connection to help avoid the hazard of electric shock by keeping any exposed conductive surface of a device at earth potential. To avoid possible voltage drop, no current is allowed to flow in this conductor (also referred to as *protective ground* in North America or as an equipment grounding conductor in the US national electrical code).

program

The component of an application that consists of compiled source code capable of being installed in the memory of a logic controller.

R

RJ45

A standard type of 8-pin connector for network cables defined for Ethernet.

T**terminal block**

(terminal block) The component that mounts in an electronic module and provides electrical connections between the controller and the field devices.



A

assembling to a controller, *34*

C

certifications and standards, *24*
controllers
 disassembling a module, *36*

D

description
 transmitter and receiver, *15*
dimensions
 TM3XTRA1, *54*

E

Electromagnetic Susceptibility, *22*
environmental characteristics, *21*

G

grounding, *43*

I

intended use, *6*

M

minimum clearances, *29*
mounting position, *29*

P

presentation
 TM3XTRA1, *52*

Q

qualification of personnel, *6*

S

specifications
 transmitter and receiver modules, *15*

T

TM3XREC1, *60*
TM3XREC1 receiver module, *59*
TM3XTRA1, *54*
 presentation, *52*
TM3XTRA1 transmitter module, *51*
transmitter and receiver modules
 description, *15*
 specifications, *15*

W

wiring rules, *39*

