

# Safety-door Switch D4GS-N

## Slim Safety-door Switches with IP67 Rating

- The slim safety-door switches with a three-terminal contact construction.
- Reversible design allowing either front or rear mounting.
- Built-in switches with two- or three-terminal contact construction are available.
- Operation Key with rubber mounting hole to absorb vibration and shock.

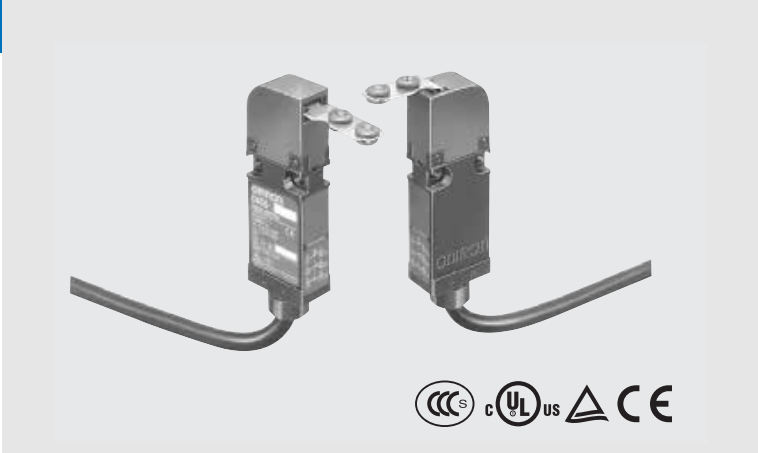

### Features

#### Slim Safety-door Switches with 3-terminal Contact Construction

Thin and 1/2 the size as OMRON's previous models.

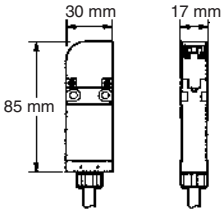

#### Reversible Design

Front and rear mounting are both possible.

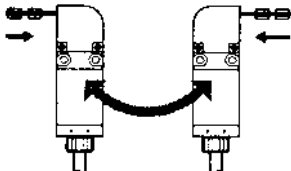

#### Built-in Switches

Two- and three-terminal contact models are available.

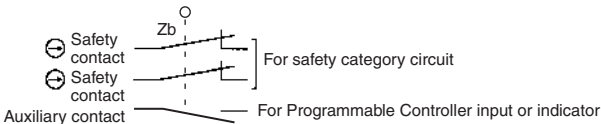

Note: The safety contacts are direct opening contacts approved by EN and each of them is indicated with the mark .

#### Key Mounting Hole

The key mounting hole is designed with rubber to absorb vibration and shock.

#### IP67 Degree of Protection

(Applicable to main body only; Operation Key insertion face meets IP00.)

The D4GS-N uses rust-resistant materials and incorporates a drain opening as effective countermeasures against problems caused by water.

Note: IP67 is based on the test method specified in EN60947-5-1. Be sure to confirm in advance the sealing performance under the actual operating environment and conditions.

#### Safety Standards

Meeting EN (TÜV) Standards and CE marking requirements along with a variety of international standard requirements, such as UL and CSA requirements. All NC contacts satisfy requirements for the direct opening mechanism.

## Model Number Structure

### Model Number Legend

#### Switch

D4GS-N□□□-□  
 1 2 3

**1. Built-in Switch**

- 1: 1NC/1NO (slow-action)
- 2: 2NC (slow-action)
- 3: 2NC/1NO (slow-action)
- 4: 3NC (slow-action)

**2. Direction of Operation**

- Key Insertion**
- R: Horizontal
  - T: Vertical

**3. Cable Length**

- Blank: 1 m
- 3: 3 m
- 5: 5 m

#### Operation Key

D4GS-NK□  
 1



**1. Operation Key Type**

- 1: Horizontal mounting
- 2: Vertical mounting
- 4: Adjustable mounting (Vertical)



## Ordering Information

### List of Models

#### Switches

Appearance	Direction of Operation Key insertion	Cable length	1NC/1NO (Slow-action)	2NC (Slow-action)	2NC/1NO (Slow-action)	3NC (Slow-action)
	Horizontal	1 m	D4GS-N1R	D4GS-N2R	D4GS-N3R	D4GS-N4R
		3 m	D4GS-N1R-3	D4GS-N2R-3	D4GS-N3R-3	D4GS-N4R-3
		5 m	D4GS-N1R-5	D4GS-N2R-5	D4GS-N3R-5	D4GS-N4R-5
	Vertical	1 m	D4GS-N1T	D4GS-N2T	D4GS-N3T	D4GS-N4T
		3 m	D4GS-N1T-3	D4GS-N2T-3	D4GS-N3T-3	D4GS-N4T-3
		5 m	D4GS-N1T-5	D4GS-N2T-5	D4GS-N3T-5	D4GS-N4T-5

### Operation Keys (Order Separately)

Type	Model
Horizontal mounting 	D4GS-NK1
Vertical mounting 	D4GS-NK2
Adjustable mounting (Vertical) 	D4GS-NK4

## Specifications

### Approved Standards

Agency	Standard	File No.
TÜV Rheinland	EN60947-5-1 GS-ET-15	J2051125  (Direct opening: approved)
UL (see note)	UL508 CSA C22.2 No. 14	E76675
CQC (CCC)	GB/T 14048.5	Contact your OMRON representative

**Note:** Approval for CSA C22.2 No. 14 is authorized by the UL mark.

### Standards and EC Directives

Conforms to the following EC Directives:

Machinery Directive  
Low Voltage Directive  
EN1088  
EN60204-1

### Approved Standard Ratings

#### TÜV (EN60947-5-1)

Item	AC-15	DC-13
Rated operating current ( $I_e$ )	0.75 A	0.27 A
Rated operating voltage ( $U_e$ )	240 V	250 V

**Note:** Use a 10-A fuse type gI or gG that conforms to IEC60269 as a short-circuit protection device.

### UL/CSA (UL508, CSA C22.2 No. 14)

#### C300

Rated voltage	Carry current	Current (A)		Voltage (VA)	
		Make	Break	Make	Break
120 VAC	2.5 A	15	1.5	1,800	180
240 VAC		7.5	0.75		

#### Q300

Rated voltage	Carry current	Current (A)		Voltage (VA)	
		Make	Break	Make	Break
125 VDC	2.5 A	0.55	0.55	69	69
250 VDC		0.27	0.27		

Characteristics

Degree of protection (see note 1)	Body: IP67 (EN60947-5-1) (Operation Key insertion face: IP00)
Durability (see note 2)	Mechanical:1,000,000 times min. Electrical:100,000 times min. (1-A resistive load at 125 VAC) (see note 3)
Operating speed	0.1 to 0.5 m/s
Contact gap	2 x 2 mm min.
Operating frequency	30 operations/minute
Direct opening force (see note 4)	60 N min.
Direct opening travel (see note 4)	10 mm min.
Insulation resistance	100 MΩ min. (at 500 VDC) between terminals of the same polarities, between terminals of different polarities, and between each terminal and non-current carrying metal parts
Minimum applicable load (see note 5)	4 mA at 24 VDC
Contact resistance	300 mΩ max. (Initial value with 1-m cable)
Dielectric strength	Between terminals of same polarities: Uimp 2.5 kV (EN60947-5-1) Between terminals of different polarities: Uimp 4 kV (EN60947-5-1) Between each terminal and non-current carrying metal parts: Uimp 6 kV (EN60947-5-1)
Conditional short-circuit current	100 A (EN60947-5-1)
Pollution degree (operating environment)	3 (EN60947-5-1)
Conventional free air thermal current (I <sub>th</sub> )	2.5 A (EN60947-5-1)
Protection against electric shock	Class II (double insulation) (IEC60536)
Vibration resistance	Malfunction:10 to 55 Hz, 0.35-mm single amplitude
Shock resistance	Malfunction:300 m/s <sup>2</sup> min.
Ambient temperature	Operating:-30°C to 70°C (with no icing)
Ambient humidity	Operating:95% max.
Cable	UL2464 No. 22 AWG, finishing O.D.: 7.2 mm
Weight	Approx. 120 g (D4GS-N1R, with 1-m cable)

- Note:**
1. The degree of protection shown above is based on the test method specified in EN60947-5-1. Be sure to confirm in advance the sealing performance under the actual operating environment and conditions.  
Although the switch box is protected from dust, oil, or water penetration, do not use the D4GS-N in places where dust, oil, water, or chemicals may penetrate through the key hole on the head, otherwise Switch damage or malfunctioning may occur.
  2. The durability is for an ambient temperature of 5°C to 35°C and an ambient humidity of 40% to 70%.
  3. When the ambient temperature is 35°C or higher, do not apply 1 A at 125 VAC to more than one circuit.
  4. These figures are minimum requirements for safe operation.
  5. The value given for minimum applicable load is a reference value for micro-loads. The value will vary depending on factors such as the switching frequency, the ambient environment, and the reliability level. Be sure to confirm correct operation with the actual load before application.

Contact Form (Diagrams Show State with Key Inserted)

Model	Contact	Diagram	Remarks
D4GS-N1□-□	1NC/1NO		<p>Only NC contact 11-12 has an approved direct opening mechanism. (→)</p> <p>The terminals 11-12 and 33-34 can be used as unlike poles.</p>
D4GS-N2□-□	2NC		<p>NC contacts 11-12 and 31-32 have an approved direct opening mechanism. (→)</p> <p>The terminals 11-12 and 31-32 can be used as unlike poles.</p>
D4GS-N3□-□	2NC/1NO		<p>Only NC contacts 11-12 and 21-22 have an approved direct opening mechanism. (→)</p> <p>The terminals 11-12, 21-22 and 33-34 can be used as unlike poles.</p>
D4GS-N4□-□	3NC		<p>NC contacts 11-12, 21-22 and 31-32 have an approved direct opening mechanism. (→)</p> <p>The terminals 11-12, 21-22 and 31-32 can be used as unlike poles.</p>

## Dimensions

- Note:** 1. All units are in millimeters unless otherwise indicated.  
 2. Unless otherwise specified, a tolerance of  $\pm 0.4$  mm applies to all dimensions.

### Switches

#### D4GS-N□R-□

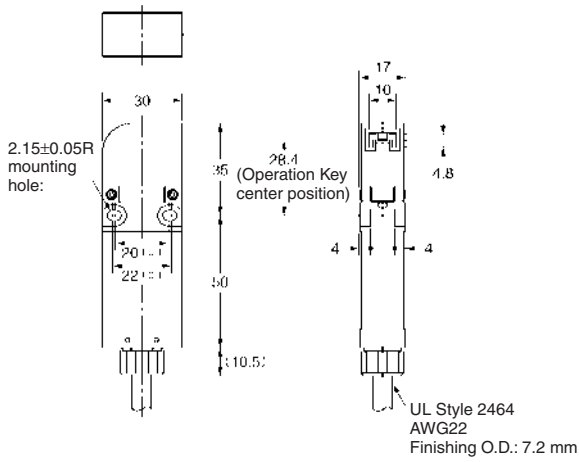
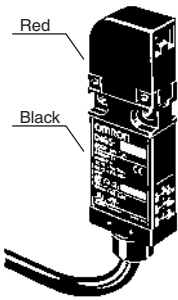

Operating characteristics	Model
Key insertion force	15 N max.
Key extraction force	30 N max.
Movement before being locked	(22 mm) min.
Direct opening force	60 N min.
Direct opening stroke	10 mm min.

#### D4GS-N□T-□

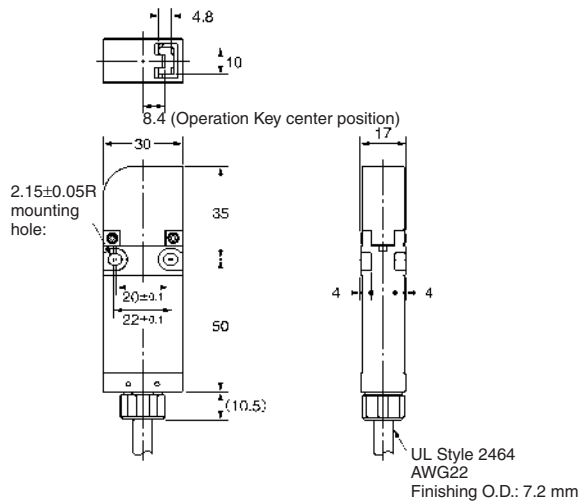
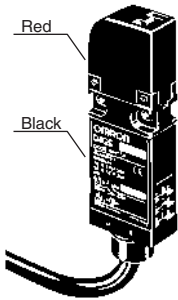

Operation Keys

D4GS-NK1

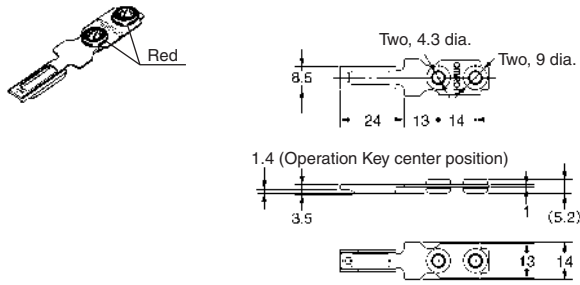

D4GS-NK2

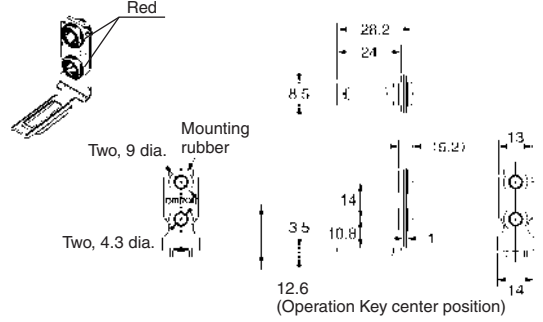

D4GS-NK4

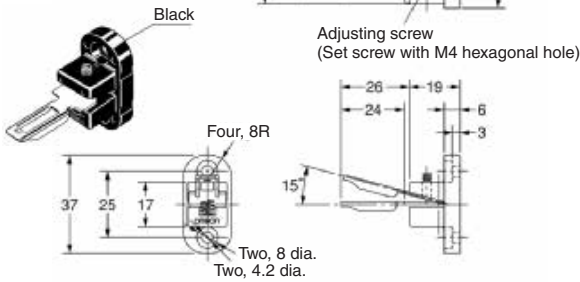

With Operation Key Inserted

D4GS-N□R-□ + D4GS-NK1

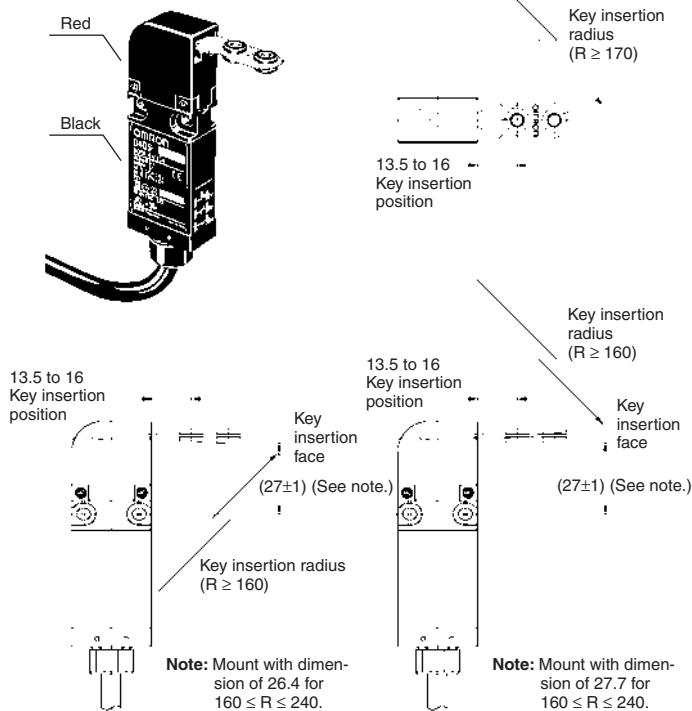

D4GS-N□R-□ + D4GS-NK2

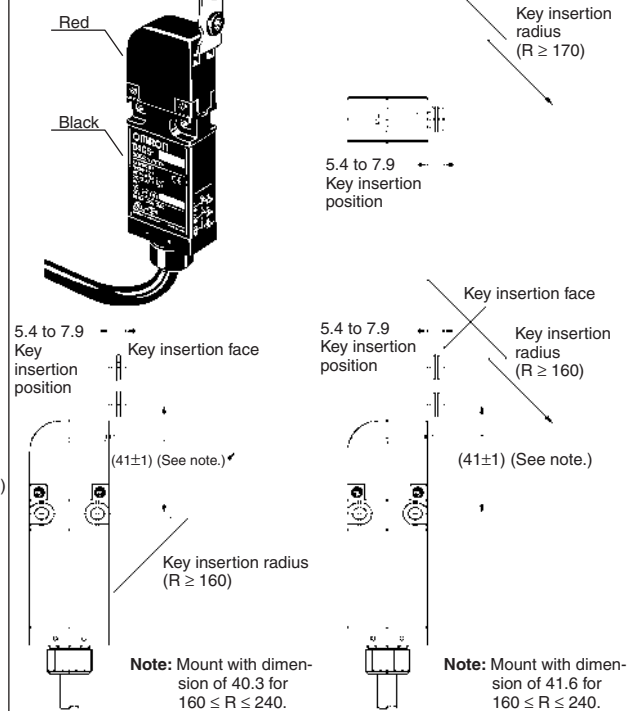

- Note:** 1. All units are in millimeters unless otherwise indicated.  
 2. Unless otherwise specified, a tolerance of  $\pm 0.4$  mm applies to all dimensions.

D4GS-N□T□ + D4GS-NK1

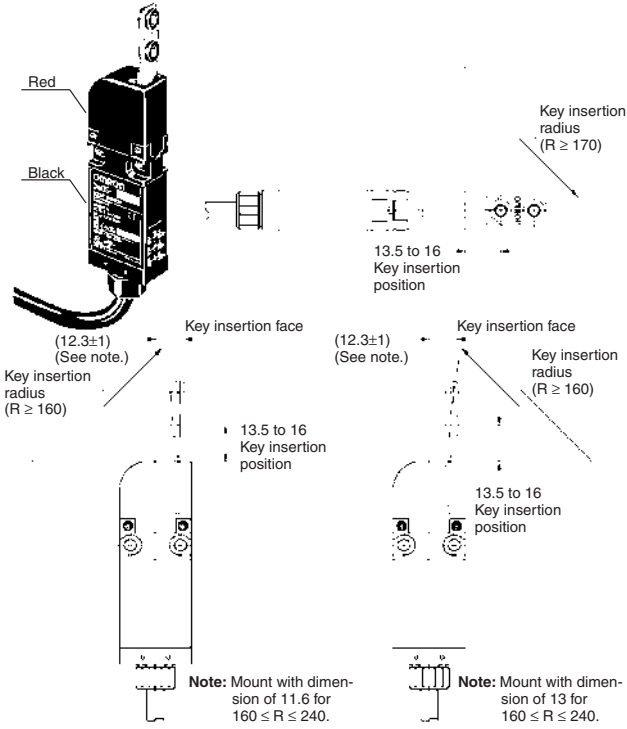

D4GS-N□T□ + D4GS-NK2

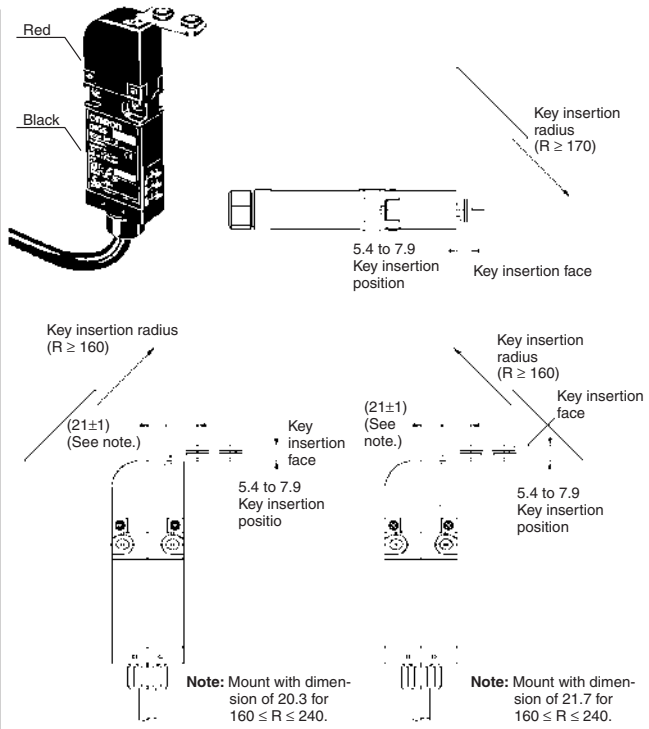

D4GS-N□R□ + D4GS-NK4

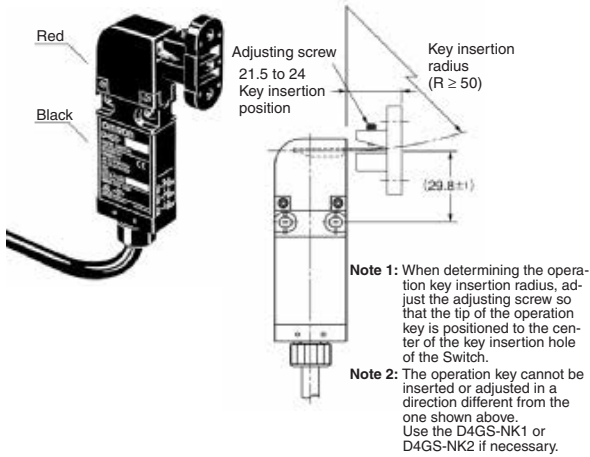

D4GS-N□T□ + D4GS-NK4

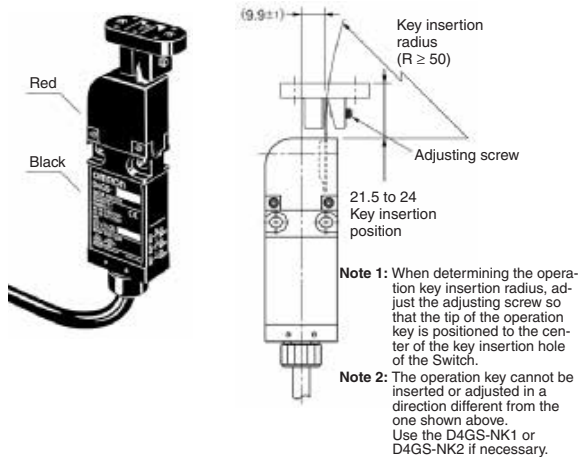

- Note: 1. All units are in millimeters unless otherwise indicated.  
2. Unless otherwise specified, a tolerance of  $\pm 0.4$  mm applies to all dimensions.



Precautions

Do not insert the Operation Key to the switch with the door open. Machine may start operating and injury may be caused.

NOTICE

Do not use the D4GS-N Switch or D4GS-NK Operation Key (rubber color: red) in combination with the D4GS Switch or D4GS-K Operation Key (rubber color: black).

Mount the Operation Key at a location where it will not come in contact with users when the door is opened or closed.

When operating the D4GS-N as a part of a safety category circuit to prevent injury, operate the NC contacts that have a direct opening mechanism in direct opening mode. For safety purposes, tighten the switch body and Operation Key with one-way screws or equivalents or install a switch protection cover and warning label for safety purposes to prevent easy removal of the D4GS-N.

Connect the fuse to the D4GS-N in series to prevent it from short-circuit damage. The value of the breaking current of the fuse must be calculated by multiplying rated current by 150% to 200%. When using the D4GS-N with EN ratings, use 10-A fuse Type gI or gG that complies with IEC60269.

Do not supply electric power when wiring.

Do not use the D4GS-N where explosive gas, flammable gas, or any other dangerous gas may be present.

Keep the electrical load below the rated value.

Never wire to a wrong terminal.

Be sure to evaluate the D4GS-N under actual working conditions after installation.

Do not drop the D4GS-N. Excessive shock or vibration can cause malfunction or damage to Switch characteristics. Do not disassemble the internal switch, there are no user-serviceable parts inside.

Do not use the D4GS-N as a stopper. When mounting the D4GS-N, be sure to locate a stopper as shown in the following illustration to prevent the top of the Operation Key from hitting the switch head.

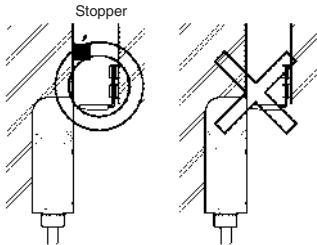

Cables should not be bent repeatedly. A cable is fixed with sealing materials on the bottom of the D4GS-N. When excessive force may be imposed on the cable, fix the cable with a fixing unit at the distance of 5 cm from the bottom of the D4GS-N as shown. When bending the cable, secure the cable with more than 45-mm bending radius so as not to cause damage to the insulator or sheath of the cable. Do not fasten or loosen the conduit at the bottom of the D4GS-N. When wiring, be sure not to allow a liquid such as water or oil into the tip of cable.

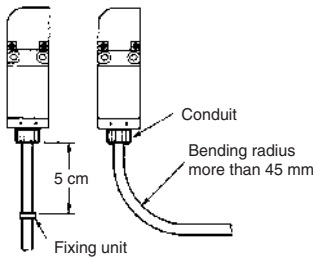

Correct Use

Operating Environment

Do not use the D4GS-N in the following locations:

- Locations subject to severe temperature changes
• Locations subject to high temperatures or condensation
• Locations subject to severe vibration
• Locations subject to metal chips, oils, and chemicals inside a protective door

Life Expectancy

The life of the D4GS-N will vary with the switching conditions. Before applying the D4GS-N, test the D4GS-N under actual operating conditions and be sure to use the D4GS-N in actual operation within switching times that will not lower the performance of the D4GS-N.

Mounting

Mounting hole dimensions for mounting the main body are as shown below.

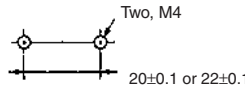

Tightening Torque

Be sure to tighten each screw of the D4GS-N properly, otherwise the D4GS-N may malfunction.

Table with 3 columns: Type, Torque, Size. Rows include Body mounting screw and Operation Key mounting screw, both with torque of 0.75 to 1.15 N·m and size of M4 screw.

Note: Mount securely, using screws of the specified size together with washers (e.g., plain or spring washers).

Operation Key Mounting Holes

D4GS-NK1/NK2

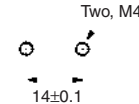

D4GS-NK4

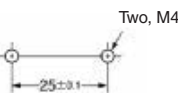

### Operation Key

Be sure to use a special Operation Key only.

Do not operate the D4GS-N with anything other than the special Operation Key. Otherwise, the Switch may be damaged.

As shown below, mount the Operation Key after matching the concave surface of the Operation Key with the convex surface of the insertion face.



Be sure to adjust the position correctly when mounting the Operation Key and the Switch to ensure that the Operation Key does not miss the insertion face and exert an excessive force on the Switch head.

Do not impose excessive force on the Operation Key inserted into the D4GS-N or drop the D4GS-N with the Operation Key inserted. Doing so may deform or damage the Operation Key.

Depending on the conditions in which the Switch is used, the rubber of the Operation Key may deteriorate. If the rubber becomes deformed or cracked, replace it as soon as possible.

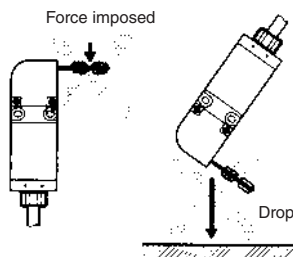

### Securing the Door

When the door is closed (with the Operation Key inserted), the door (or the Operation Key) may be pulled outside the set zone due to the door's weight or the door cushion rubber. If a load is applied to the Operation Key, the door may fail to unlock. Secure the door with hooks so that it will remain within the set zone.

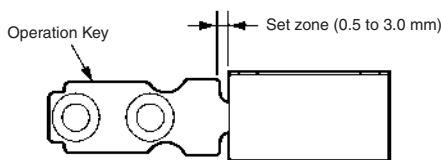

### Wiring

#### Identifying Wires

Identify wires according to the color (with or without white lines) of the insulation on the wire.

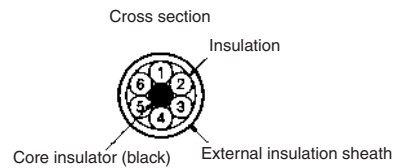

#### Wire Colors

No.	Color of insulation	No.	Color of insulation
1	Blue/white	4	Orange
2	Brown/white	5	Brown
3	Orange/white	6	Blue

Note: "Blue/white, brown/white, or orange/white" means that the cover is blue, brown, or orange with a white line.

#### Terminal Numbers

Identify terminal numbers based on the color of the insulation on the wire.

The safety and auxiliary contacts of D4GS-N models of three-terminal contact construction and those of two-terminal contact construction are described below.

The auxiliary contacts (orange) can be used as safety contacts.

The safety contacts are direct opening contacts approved by EN and each of them is indicated with the mark  $\ominus$ .

#### <3NC>

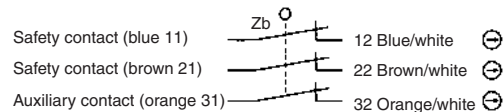

#### <2NC/1NO>

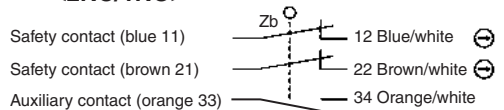

#### <2NC>

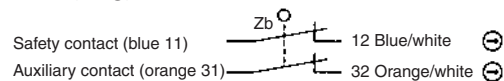

#### <1NC/1NO>

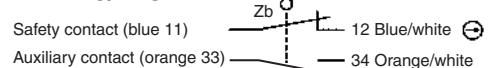

Cut the black core insulator and all unused wires at the end of the external insulation sheath when wiring the cable.

ALL DIMENSIONS SHOWN ARE IN MILLIMETERS.

To convert millimeters into inches, multiply by 0.03937. To convert grams into ounces, multiply by 0.03527.