

# Product Data Sheet

## GW44636

46 Range

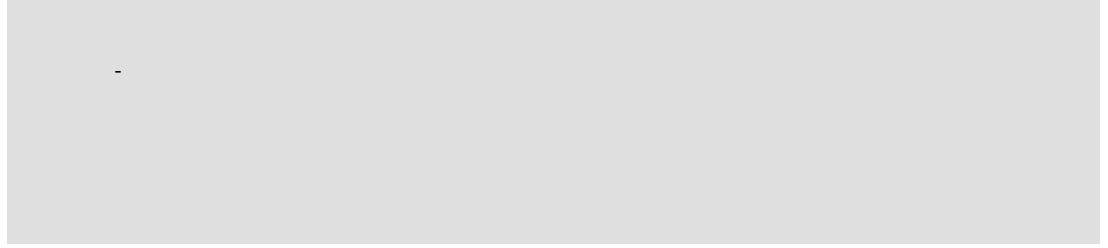

For boards LxH (mm)	200x254	For boards	44 CEP
Type of material	Galvanized metal	Electrocod	1320

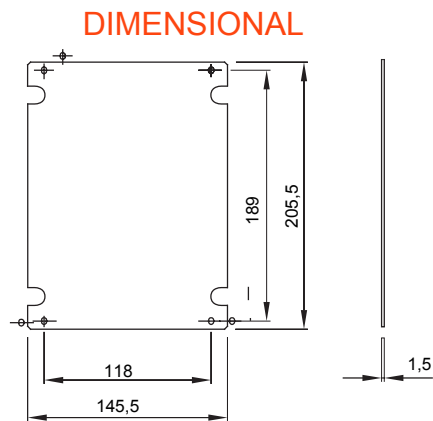

### STANDARDS/APPROVALS

