

LED Slim Panel Ecomax G4

OPPLE

Version date 21-07-2022
www.opple.com





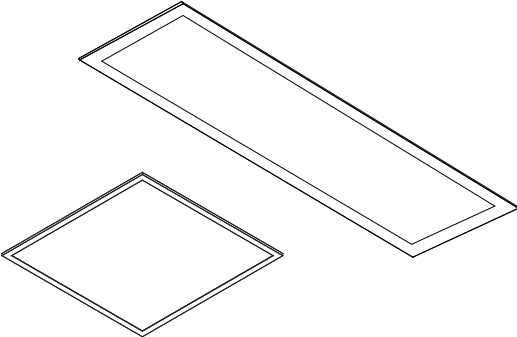
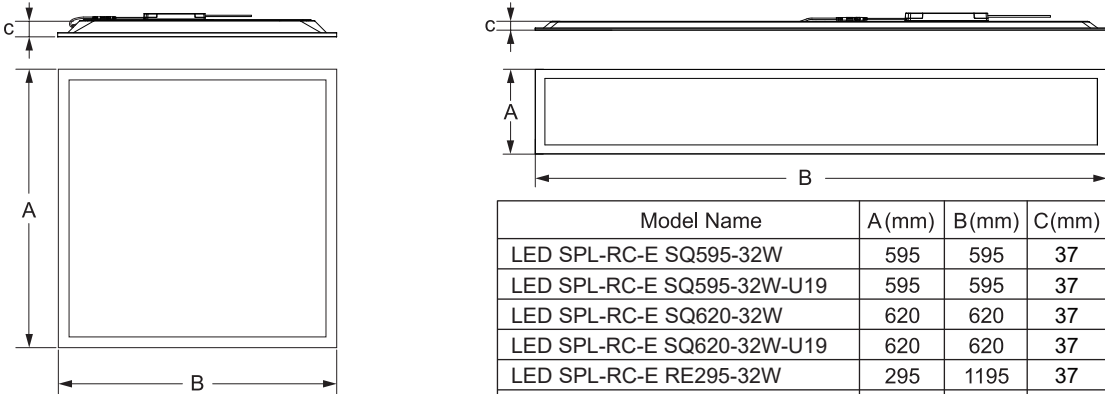



Item Code	Luminaire Description	CCT	kg
542003098500	LEDPanelS-E4 Sq595-32W-830-U19	3000K	1.85kg
542003098600	LEDPanelS-E4 Sq595-32W-840-U19	4000K	1.85kg
542003098700	LEDPanelS-E4 Sq620-32W-830-U19	3000K	2.09kg
542003098800	LEDPanelS-E4 Sq620-32W-840-U19	4000K	2.09kg
542003098900	LEDPanelS-E4 Re295-32W-830-U19	3000K	1.77kg
542003099000	LEDPanelS-E4 Re295-32W-840-U19	4000K	1.77kg
542003099700	LEDPanelS-E4 Sq595-32W-830	3000K	1.46kg
542003099800	LEDPanelS-E4 Sq595-32W-840	4000K	1.46kg
542003099900	LEDPanelS-E4 Sq620-32W-830	3000K	1.69kg
542003100000	LEDPanelS-E4 Sq620-32W-840	4000K	1.69kg
542003100100	LEDPanelS-E4 Re295-32W-830	3000K	1.39kg
542003100200	LEDPanelS-E4 Re295-32W-840	4000K	1.39kg
542003021700*	LEDPanelRc-S-B2 Suspension-Kit	/	0.25kg
542003021800*	LEDPanelRc-S-B2 Mounting-Springs	/	0.1kg
542098033000*	LEDPanelRc-S-B2 Re298 Mounting-Springs	/	0.126kg

* Accessories should be purchased separately.





Model Name	A (mm)	B (mm)	C (mm)
LED SPL-RC-E SQ595-32W	595	595	37
LED SPL-RC-E SQ595-32W-U19	595	595	37
LED SPL-RC-E SQ620-32W	620	620	37
LED SPL-RC-E SQ620-32W-U19	620	620	37
LED SPL-RC-E RE295-32W	295	1195	37
LED SPL-RC-E RE295-32W-U19	295	1195	37

Light Source

Product Code	Product Description	N	Light source code	QR Code	Energy Label
542003098500	LEDPanelS-E4 Sq595-32W-830-U19	6	LS030003212-01		
542003098700	LEDPanelS-E4 Sq620-32W-830-U19	6			
542003099700	LEDPanelS-E4 Sq595-32W-830	6			
542003099900	LEDPanelS-E4 Sq620-32W-830	6			
542003098600	LEDPanelS-E4 Sq595-32W-840-U19	6	LS030003215-01		
542003098800	LEDPanelS-E4 Sq620-32W-840-U19	6			
542003099800	LEDPanelS-E4 Sq595-32W-840	6			
542003100000	LEDPanelS-E4 Sq620-32W-840	6			
542003098900	LEDPanelS-E4 Re295-32W-830-U19	2	LS030003212-02		
542003100100	LEDPanelS-E4 Re295-32W-830	2			
542003099000	LEDPanelS-E4 Re295-32W-840-U19	2	LS030003215-02		
542003100200	LEDPanelS-E4 Re295-32W-840	2			

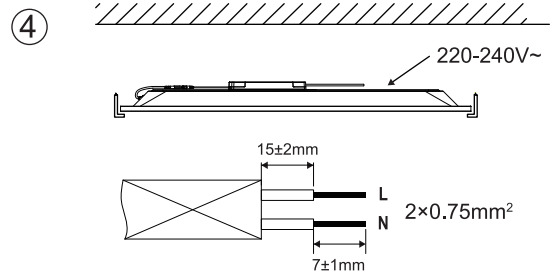
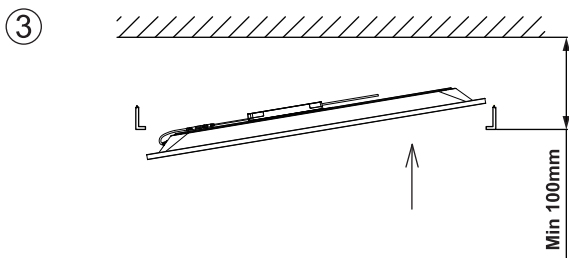
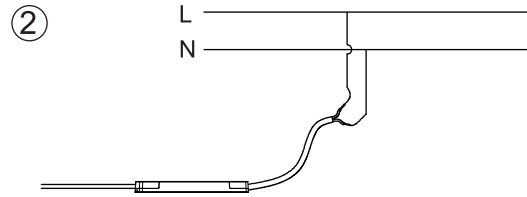
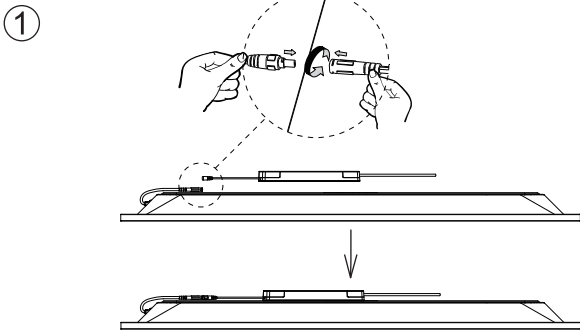
Wire Connection & Recessed Installation



Terminal block not included. Installation may require advice from a qualified person. Only use suitable connection boxes with internal terminal blocks conform to EN60998-2-1 or EN60998-2-2 Terminal should be capable for at least 450V 16A, 0.75mm² wiring.

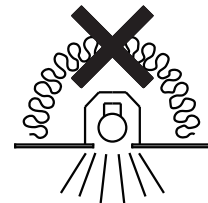
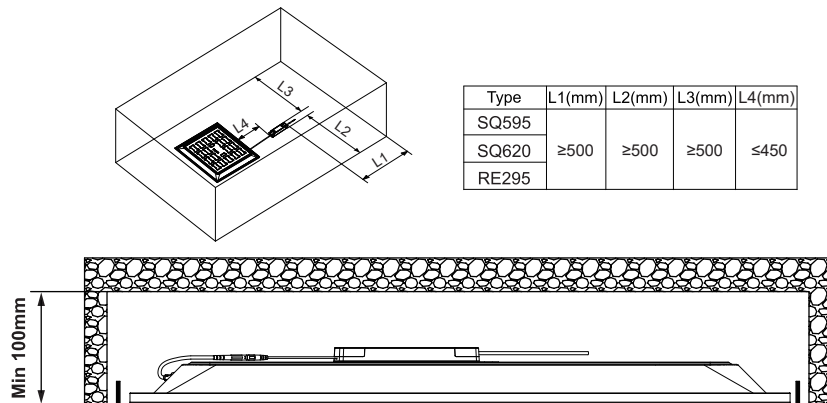

Do not cover with insulation material

Suspended Installation (Suspension kit)

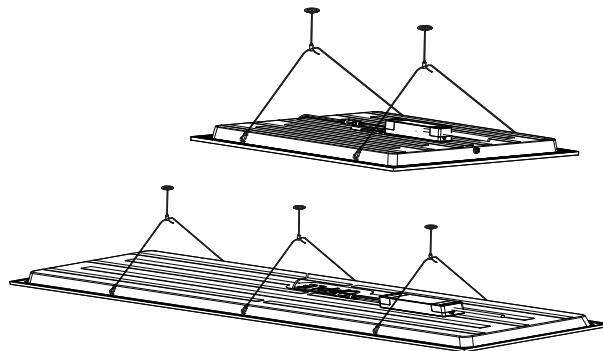
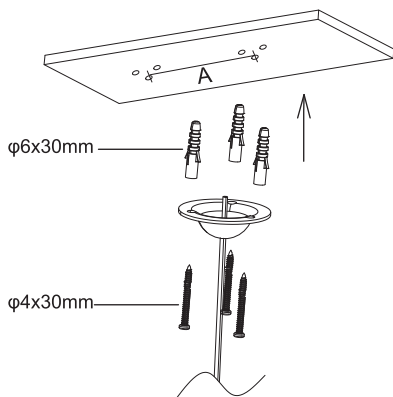

Panel LED A
595×595 331mm

Panel LED A
620×620 331mm

Panel LED A
295×1195 208mm

Recessed Mounting (Mounting Springs)

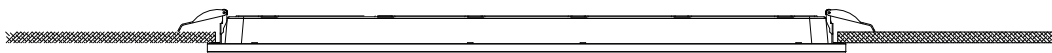

①

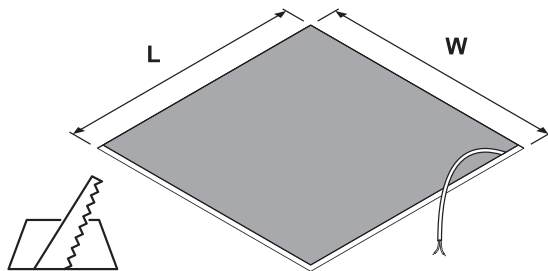

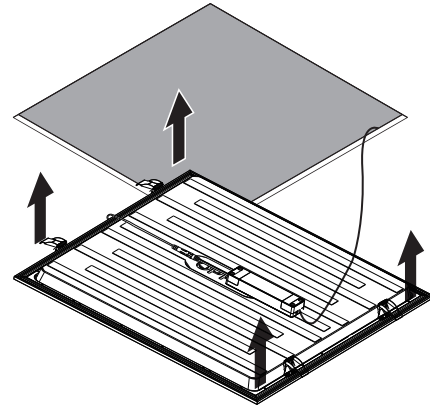

②



Panel LED	L	W		x4		x8
595×595	580mm	580mm				

Panel LED	L	W		x4		x8
620×620	597mm	597mm				

Panel LED	L	W		x6		x12
295×1195	280mm	1180mm				

Caution

The luminaire is only suitable for safety extra low voltage supply (<50Va.c.; <120Vd.c.).

The controlgear for the connection panel should be SELV.

It must be basic insulation between FELV and SELV, as is FELV and LV supply for 1-10V and DALI type.

For non-user replaceable light sources:

The light source contained in this luminaire shall only be replaced by the manufacturer or his service agent or a similar qualified person.

Terminal block not included. Installation may require advice from a qualified person.

Only use suitable connection boxes with internal terminal blocks conform to EN60998-2-1 or EN60998-2-2 Terminal should be capable for at least 450V 16A, 0.75mm² wiring.



Caution: Any operation on LED module is forbidden while power-on.

Zur Vermeidung von Risiken müssen defekte Leitungen ausschließlich vom Hersteller, Inverkehrbringer oder Fachmann ausgetauscht werden.

Achtung: In Betrieb ist keine Arbeit am LED-Modul erlaubt.

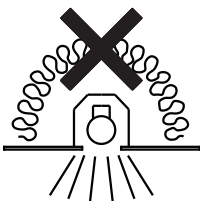

Luminaires not suitable for covering with thermally insulating material.

Leuchten sind nicht mit thermisch isolierenden Materialien abzudecken.

In case of damage to the wire, it has to be replaced only by the manufacturer, distributor or by an expert, to avoid risks.

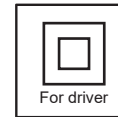
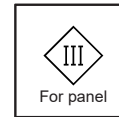
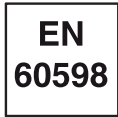

Data subject to change
Les données sont sujettes à modifications
Änderungen vorbehalten

Suzhou Oppl Lighting Co.,Ltd.
215200
East Side, Fenyang Road,
Fenhu Economic Development Zone,
Wujiang City, Jiangsu Province,
P.R.China

Oppl Lighting BV
Meerenakkerweg 1.11
5652 AR Eindhoven
The Netherlands
service@opple.com
www.opple.com