

# Unica

Catalogue 2016





P113219

Unica Class



P113192

Unica Top



P86203

Unica Plus



P84932



# Appearance counts

Unica Quadro



PR104530

Unica Allegro



PR106338

Unica Colors



PR11459

Unica Basic



PR106055



# Contents

## Presentation

|   |    |
|---|----|
| Unica ranges overview . . . . .   | 6  |
| Solutions for comfort, communication, safety<br>and energy-saving . . . . . | 8  |
| Unica for KNX system . . . . .  | 16 |
| Comprehensive functionalities . . . . .                                     | 22 |
| Two installation architectures . . . . .                                    | 24 |
| The modularity system . . . . .   | 26 |
| Technical benefits . . . . .  | 28 |

## Unica Class, Top

|   |    |
|---|----|
| Presentation . . . . .                            | 30 |
| Inserts . . . . .                                 | 32 |
| Wireless inserts . . . . .                        | 56 |
| KNX inserts. . . . .                              | 59 |
| Fixing frames and boxes. . . . .                  | 61 |
| Unica Class aesthetics and cover frames . . . . . | 62 |
| Unica Top aesthetics and cover frames . . . . .   | 72 |

## Unica Plus, Quadro, Allegro, Colors, Basic

|   |     |
|---|-----|
| Presentation . . . . .                              | 82  |
| Inserts . . . . .                                   | 86  |
| Wireless inserts . . . . .                          | 113 |
| KNX inserts. . . . .                                | 116 |
| Fixing frames and boxes. . . . .                    | 118 |
| Unica Plus aesthetics and cover frames . . . . .    | 120 |
| Unica Quadro aesthetics and cover frames . . . . .  | 132 |
| Unica Allegro aesthetics and cover frames . . . . . | 138 |
| Unica Colors aesthetics and cover frames . . . . .  | 144 |
| Unica Basic aesthetics and cover frames . . . . .   | 150 |

## Technical information

|  |     |
|--|-----|
| (excluding Unica Wireless and KNX) . . . . . | 155 |
|--|-----|

## Unica Wireless

|                                 |     |
|---------------------------------|-----|
| Presentation . . . . .          | 214 |
| Scenarios. . . . .              | 218 |
| Quick-selection guide . . . . . | 222 |
| Technical information. . . . .  | 224 |

## Unica KNX

|                                 |     |
|---------------------------------|-----|
| Presentation . . . . .          | 238 |
| Quick-selection guide . . . . . | 242 |
| Technical information. . . . .  | 243 |

|                             |     |
|-----------------------------|-----|
| Reference numbers . . . . . | 246 |
|-----------------------------|-----|

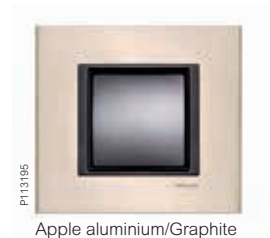
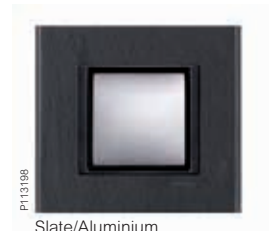

## Unica Class

Modern life makes us long for nature, with the original, true and pure building blocks of our existence. Like the comforting sight of clear ocean waves, the dust from ochre-colored soil. Or the unexpected chilly hardness from a jagged piece of rock...

Unica Class cover frames brings the roughness of minerals, the beauty of crystal transparency and many other sensations into your life. Open your door and let nature into your home!

## Unica Top



A Unica Top choice is what it sounds like. A top choice! Concern about detail is necessary to make a perfect result. Unica Top is made to last, and to make a lasting impression. Don't miss out on the distinction. Find what exclusively matches you!

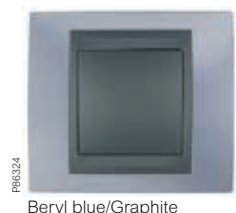



P80191

## Unica Plus

Includes that little extra that makes a difference. Satisfying high demands concerning longevity, functionality and cared design. A choice signalling exclusiveness – carrying the impression and comfort of your home to new levels.



P80229



P81412



P105782

## Unica Quadro

The trendy choice. Provides your home with a young, fresh, minimalistically modern look. In sparkling red or aesthetic silver. Make a statement: Every spot in your home is worth design attention.



P104523



P104529



P80174

## Unica Allegro

A temptingly multifunctional and prominent choice. In a range of metallised colours to mix and match. Will blend with almost any style. Has the qualities and aesthetics of a designer's best friend.



P86322



P86338



P80200

## Unica Colors

Give each room its own personality. Match your style and interior, as often as you please. A real versatile choice, with several opportunities.



P84986



P81461



P80180

## Unica Basic

A choice clearly above the design of the mainstream selection. With a sober, timeless stylish expression, pointing out that you have high standards and care about what your home looks like.



P84952



P80355

# Solutions for comfort, safety and energy-saving

Imagine exploring the resources of Unica in every detail, in order to enhance the refined and elegant atmosphere of your home. Wouldn't a decorator's bliss be to find that with the numerous shapes and colours would also be included the most imaginative functions for cerebral and sensuous comfort? And – at the tip of your finger, getting energy-saving.

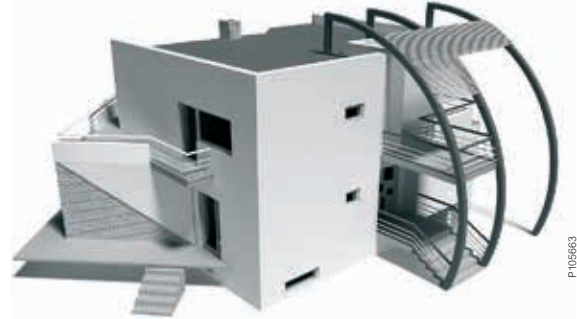

P1036683

## Living-room

**Weekly programmable thermostat**  
Have your home at the right temperature every time. Saves energy – and keeps you comfortable!

**Weekly programmable timer**  
Will save an unexpected amount of energy and prolong the lifetime of your entertainment system.

**Loudspeaker socket**  
Enjoy the access of your sound system at every point.

**Weather station**  
Making decisions easier while chasing kids into the right clothes

**Roller-blind (and/or curtain) switch**  
Lights out for movie time, or good morning sunshine?  
Done in a few seconds.

**Switch with indicator lamp**  
Signals that a light is on at the terrace.

**Wireless comfort**  
Do you want different lighting scenarios? Or a centralized roller-blind control? No problem! With Unica remote control and movable push-buttons you are in charge from your sofa.



P1036650  
Wireless push-button for scenarios



P104878  
Remote control

## Bedroom

**Save the energy – with enhanced comfort**  
Prefer a cool bedroom at night?  
The thermostat adds power only when necessary.

**Wireless comfort**  
With Unica remote control or a wireless switch beside the bed you are in charge from the pillow.

**More Unica Top in the bedroom**  
Wake-up clock. Light dimmer. Weather station. Roller-blind control.



P103651  
Wake-up clock



P104878  
Remote control

## Bathroom

**Weekly programmable thermostat**  
To have the home at the right temperature every time, optimizing the energy.

**Signal lamp**  
If this room is occupied – you will know.

**Cord push-button**  
Be smart! A panic alarm command – just in case!

**Emergency light**  
Ever been in a bathroom without windows during a power failure? Don't be!

**Flood detector**  
Protect your bathroom against flooding.



P103652  
Weekly programmable thermostat



P103346



## Staircase



Time delay switch

**Time delay switch**  
For areas where you pass through. Truly energy-saving will make sure the light is only on for a short time, no need to think about switching off. Can easily be combined with a push-button.



Switch with blue locator lamp

## Garage

**Time delay switch**  
For areas where you pass through. Will make sure the light is only on for a short time.

**Basic thermostat**  
One of the best places to save energy. A precise control of temperature, without significant drops or increases.

**IP44/IP55 covers or surface boxes**  
For extra safety and protection using electric equipment.

**Switch with blue locator lamp**  
Blue lamp. Always on.

**Flood and gas detector**  
Protect your home against flooding and gas leakage.

## Kitchen



Rotary dimmer

**Weekly programmable thermostat**  
Let the heart of your home be a warm kitchen. But not too warm!

**Weekly programmable timer.**  
Program the working time of some loads. Saves energy!

**Double-pole switch**  
Double electrical safety. Isolate your devices completely from the installation. Extra important in a kitchen.

**High rating switch**  
Need to run high amp loads at the same time? Without blowing your fuse (or the kitchen fuse).

**Alarm-clock**  
Clock- and alarm function.

**Dimmer**  
Create lighting ambiances, save energy and money.



Weekly programmable timer

## Laundry

**Weekly programmable timer.**  
Program the working time of some loads. Saves energy! And makes sure you are not leaving appliances turned on by mistake.

**Basic thermostat**  
One of the best places to save energy. A precise control of temperature, without significant drops or increases.

**IP44/IP55 covers or surface boxes**  
For extra safety and protection using electrical equipment.



Roller-blind switch

## Home office

**Weekly programmable thermostat**  
To have the home at the right temperature every time is comfortable and it also optimizes the energy.

**Wireless comfort**  
With Unica remote control or a wireless switch on your desk, you are in charge of almost any function in the room.

**Weekly programmable timer**  
Lights up or starts up (or shuts down) your preferred devices. Will save an unexpected amount of energy and prolong the lifetime of your computer system, printers etc.

**Loudspeaker socket**  
Enjoy the access of your sound system.

**Roller-blind (and/or curtain) switch**  
Lights out or not? Easy peace!



Emergency light

## Entrance

**Key card switch**  
Welcome home! Easily turns on preferred lights and devices from one single point. Activated by you, unlocking the door. Or deactivated, when you lock and leave.

**Weekly programmable thermostat**  
To have the home at the right temperature every time, optimizing the energy.

**Switch with blue locator lamp**  
Blue lamp. Always on.

**Emergency light**  
Find your way out safely in case of a power failure!

## Storage



Movement and presence detector

**Switch with blue locator lamp**  
Blue lamp. Always on.

**Signal lamps**  
So that you can tell the status of any connected device, without having to go in there and check.

**Movement and presence detector**  
Automatically activates light (or other functions) when you enter.



P113207

Comfort

# Your home is your considerate friend

Your Unica home helps you keep the right atmosphere at any moment. All day and all night. Any season of the year, your house knows what you need, what you like and how to get you in the right mood. You can direct a suiting ambience for the occasion, and recall it all, at the touch of a button. No sweat. Make the most of your energy – and do it with comfort.



P116587

**Thermostat**

To get the right temperature at home, to save energy and money. Regulation at finger tips. Clear indication.



P116582

**Roller-blind**

Roller-blind command in the same cover frame and finish as the rest of the wiring devices. With Unica wireless you can centralize the command and close all shutters at the same time.



P116583

**Movement and presence detector**

The light when you need it without looking for switches. Good comfort for children, when people wake up at night. Saves energy and money.



P116584

**Rotary dimmer**

Create light ambiances as you want them. Saves energy, and money.



P116585

**Weather station**

Weather indication in one sight. Gives humidity, temperature in the room, atmospheric pressure, clock.



P116586

**Time delay switch**

Stops automatically, you don't need to think about switching off. You can regulate the time you want the switch to be on.



P104878



P104154



## Communication

# Stay connected

Real-time communication, sharing and distributed on-demand entertainment are a natural part of your life. The demands of effective data transfers push things forward at an incredible speed as the connected community grows.

E-mail, message, on-line gaming, IP phones, music and video mix and redefine the concept of home entertainment and communication. Information is always there when you need it and your good friends are at close reach. Voice, data and living images put you on the spot where it happens, even when you are at home. Your home becomes your hub of life.



**TV-SAT socket-outlet**  
Main standards available. Different types of gain loss and installation habits.

P116589



**RJ45 data socket**  
Main standards available. Compatible with main connectors. Full range of infraplus and LexCom data sockets.

P116589



**RJ12 data socket**  
Socket for telephone service.

P116590



P104137



P113237



P104155



P104180

Centralization cover frame, 2 x 6 modules, with outlets. Glossy chrome/aluminium.



P105740

**Loudspeaker socket**  
Choose the best place for your loudspeaker sockets. Or add a few for extra comfort.



P105647

**Wake-up clock**  
A clock with many functions; time, temperature, alarm-clock with up to 9 programmable alarms. Same design as other Unica wiring devices.



P105741

**Buzzer**  
Door-bell. Same design as other Unica wiring devices.



P105742

**Electronic door-bell**  
Choose between 5 different melodies. Same design as other Unica wiring devices.



P111136

## Safety and security

# Your reliable guard

Who looks after your home when you're on holiday? Your friends and family? Well, in a former life maybe. Nowadays your home looks after itself, with the use of Unica Top weekly programmable thermostats and timers. Of course electricity in itself is a powerful source. And if it's left uncontrolled it can be dangerous and cause extensive damage. A Unica home helps avoid those problems. Your home is your reliable guard. But take a tip and invite your friends and family to stay in your house anyway. Not to look after it, but to enjoy it.

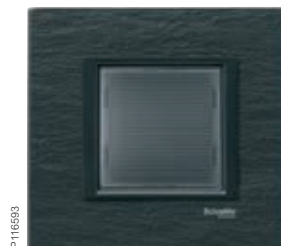

P116593

### Emergency light

To get some light in case of power failure, it has a battery inside. Suitable in stairs for instance or corridors.



P116591

### Shuttered socket-outlet

Safety for children. Also available with a hinged flap.



P116592

### Key rotary switch

The key is the command for the switch, only the key can allow one of the two positions (on/off). If you remove the key, the access is blocked. Save energy and money, keep the lead on light.



P113236



P113 394



P104153



P105746

**Key card switch**  
Can control access, lights, equipments.



P106657

**Emergency light**  
Find your way out safely in case of power failure!



P124835

**Fuse holder**  
Protects the electric system from short circuits. Can add more security in laundry, kitchen for instance.



P129480

**Technical alarms**  
Gas detectors: they are used to sound an alarm as soon as methane or LPG gas starts dissipating into the ambient air.  
Flood detector: it is designed to detect a water leakage in order to prevent water damage.

# Wireless comfort

Unica Wireless is a range of wireless products which use radio technology (RF) to exchange information. The products are highly suitable for refurbishment work in residential and small building environments without damaging the walls.

They make it considerably easier and far more pleasant to control lighting and roller blinds in the home. They are simple to install and program.

## Scenario 1: Add a switch

Add a switch beside the bed to switch the bedroom ceiling lamp on or off without getting up.

Replace the existing switch with a Unica Wireless combined module.

Stick a new battery-powered push-button onto the wall beside the bed.

Link them by simple programming.



P104989

## Scenario 2: Create a centralised roller-blind control system

Create a centralised roller-blind control system to open or close all the blinds in the house with just one button.

Replace each individual roller-blind control with a Unica Wireless roller-blind module.

Stick a Unica Wireless battery-powered push-button for the centralised control in the required position.

Link them by simple programming.



P105451

## Scenario 3: Create lighting scenarios

Create lighting scenarios to change the lighting atmosphere instantly in different rooms: for watching TV, cooking, etc.

Replace the existing switches by Unica Wireless combined modules. If necessary, add mobile socket outlets to connect standard lamps, table lamps, etc.

Add a battery-powered push-button with the symbols corresponding to the various scenarios.

Link them by simple programming.



P105420



P105421



P105346



## Scenario 4: Control the lighting and roller-blinds in each room

Control the lighting and roller blinds in each room by grouping all the controls together in one place and duplicating them on a remote control.  
 Replace the existing switches (light, blinds) by wireless combined modules.  
 Stick battery-powered push-buttons in convenient places.  
 Add a remote control containing the main functions.  
 Link them by simple programming.

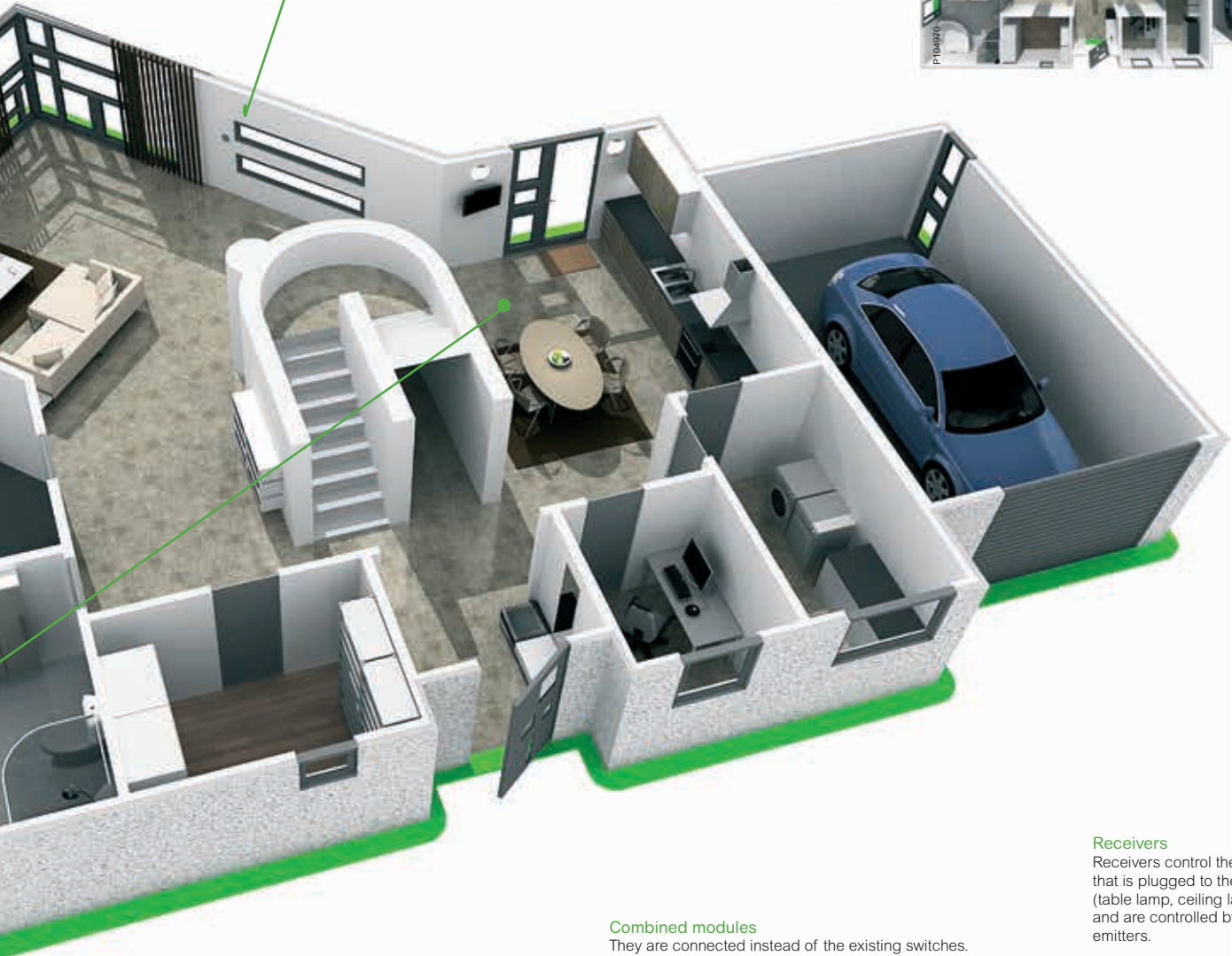

### Emitters

Emitters are battery-operated and can be screwed or stuck wherever you wish to add a control point, without connecting them to the mains supply.



Battery-powered push-button



Keyring remote control

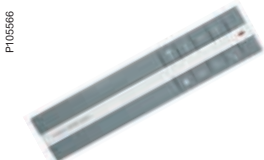

Metal remote control



Universal wireless emitter



Combined relay or dimmer



Combined module for roller-blind



Mobile socket-outlet, relay or dimmer



Universal wireless receiver (relay)

### Combined modules

They are connected instead of the existing switches. The key is used for local control; when a second key is mounted it can be used as an emitter to pilot another wireless receiver.

### Receivers

Receivers control the load that is plugged to them (table lamp, ceiling lamp, etc.) and are controlled by the emitters.

# Unica for KNX system





P117504

## Greater flexibility and comfort, better energy efficiency with KNX

More and more electronic appliances are needed for modern comfortable homes that contain everything from computers to home cinemas. Does this mean simply increase electricity consumption despite rising energy costs?

A better, faster, cheaper and cleaner solution is to use energy more efficiently. This is not only better for the environment but for your wallet too.

P109532



# Intelligent and good looking home

P117500

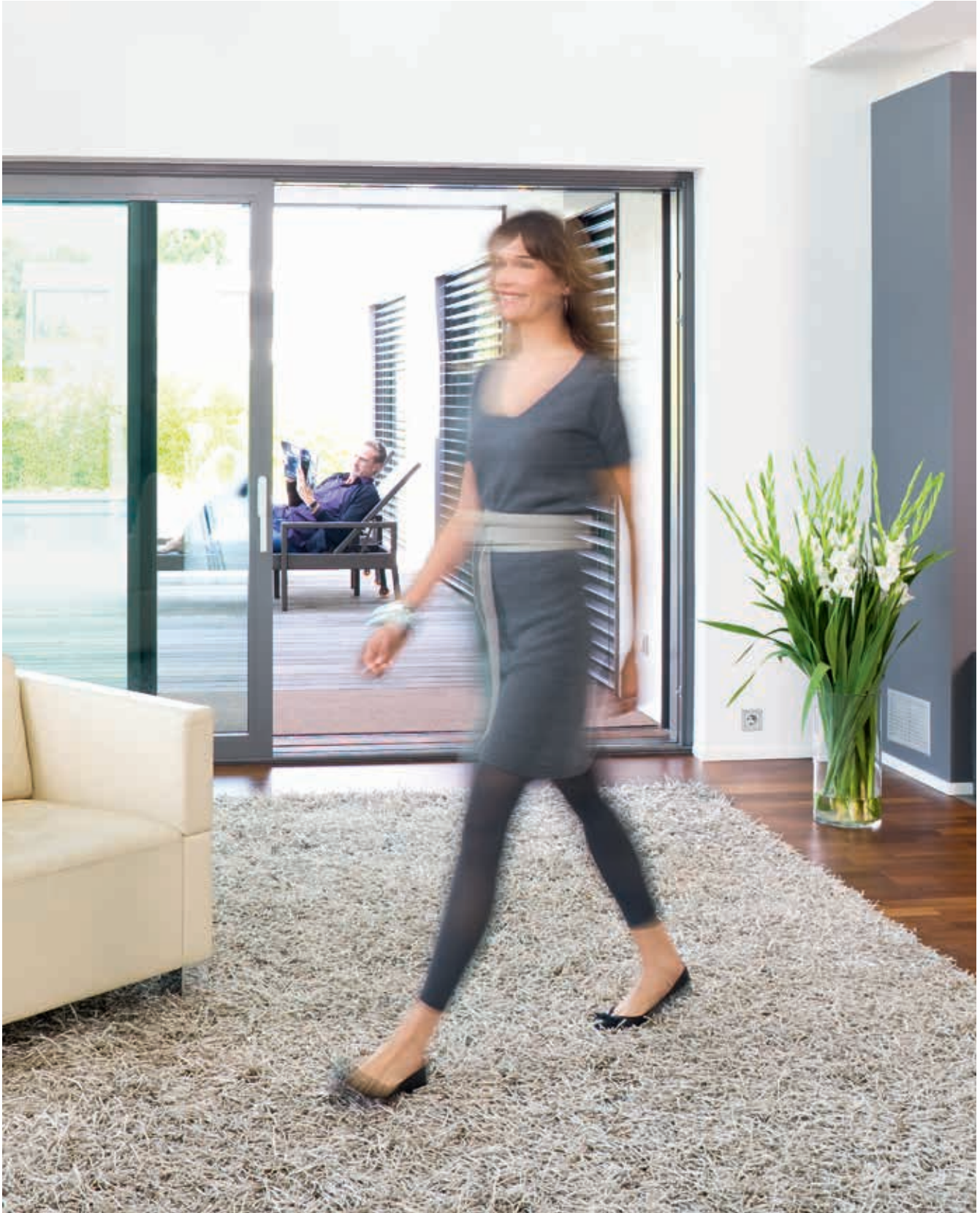

# Connect Unica to your KNX system!



P117503



Reading in your favourite armchair in the evening, watching TV on the sofa or dining with family or friends is all the more comfortable if you don't have to get up to switch each light, lamp or thermostat on or off individually.

By setting up individual scenes – for instance using a Unica multi-function push-button – you can combine a wide range of different functions. Once a scene has been created, it can be started at the push of a button – to create a suitable light mood when watching TV or reading for instance or when leaving the house in the morning. If, when doing so, you want the blinds to be raised, the lights switched off and heating turned down, you can activate the «Not at home» scene and all functions will be executed automatically.

P119163



#### Push-button

- Can be used to control lights or roller blinds.
- The system can be used to control lights and roller blinds according to the sunlight when coupled with a sensor.

P119165



#### IR push-button

- Can be used to control lights or roller blinds.
- Can be controlled by KNX IR remote control.

P119161



P119164



#### Automatic lighting control

- Can activate roller blinds or lights
- The system can be used to control lights and roller blinds according to movement detection in corridors, staircases.

P105832



Interested by the intelligent system?  
See [KNX catalog](#)

P119162



#### Individual heating control

- Presence-dependent room heating.
  - Heat is supplied automatically at the exact time required and individually via controllable room temperature control units. No need to turn the radiators up and down manually.
- Don't worry: if you forget to do it, the KNX system will remember to do it for you.

# Comprehensive functionalities

Imagine every necessary technical function and appliance that you would wish to be available in your home. The Unica range will most certainly cover every corner of those needs. And be assured, under the attractive surface, every Unica product offers a quality construction. So please, pay a moment of attention to our Unica State Of The Art "Outletology" Chart. Make your choices, and get ready to plug and play.



European socket-outlet



TV FM SAT socket



RJ12 data socket



German socket-outlet



RJ11 data socket

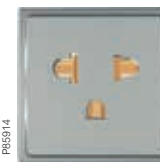

Euroamerican socket-outlet



European socket-outlet



French socket-outlet



British socket-outlet

|         |   |   |         |   |                           |         |   |                                |
|---------|---|---|---------|---|---------------------------|---------|---|--------------------------------|
| P85983  |    | Weather station                                     | P80317  |    | Basic thermostat          | P85949  |    | Indicator lamp, green          |
| P85957  |    | Switch with blue locator lamp                       | P85952  |    | Key card switch           | P85918  |    | Indicator lamp, orange         |
| P85980  |    | Push-button with bell symbol and blue locator lamp  | P85909  |    | 4-position switch         | P85920  |    | Indicator lamp, white          |
| P85946  |    | Push-button with light symbol and blue locator lamp | P85911  |    | Fuse holder               | P80319  |    | Movement and presence detector |
| P85905  |   | Roller-blind  | P85912  |   | Buzzer                    | P104689 |   | Wake-up clock                  |
| P85907  |  | Push-button with bell symbol                        | P85913  |  | Electronic doorbell       | P101843 |  | Methane and LPG gas detectors  |
| P85936  |  | Push-button I/O                                     | P85917  |  | Double switch             | P101844 |  | Flood detector                 |
| P104677 |  | Rotary dimmer                                       | P104679 |  | Time delay switch         |         |   |                                |
| P104678 |  | Key rotary switch                                   | P85958  |  | Push-button dimmer switch |         |   |                                |

# Two installation architectures

## Modular universal

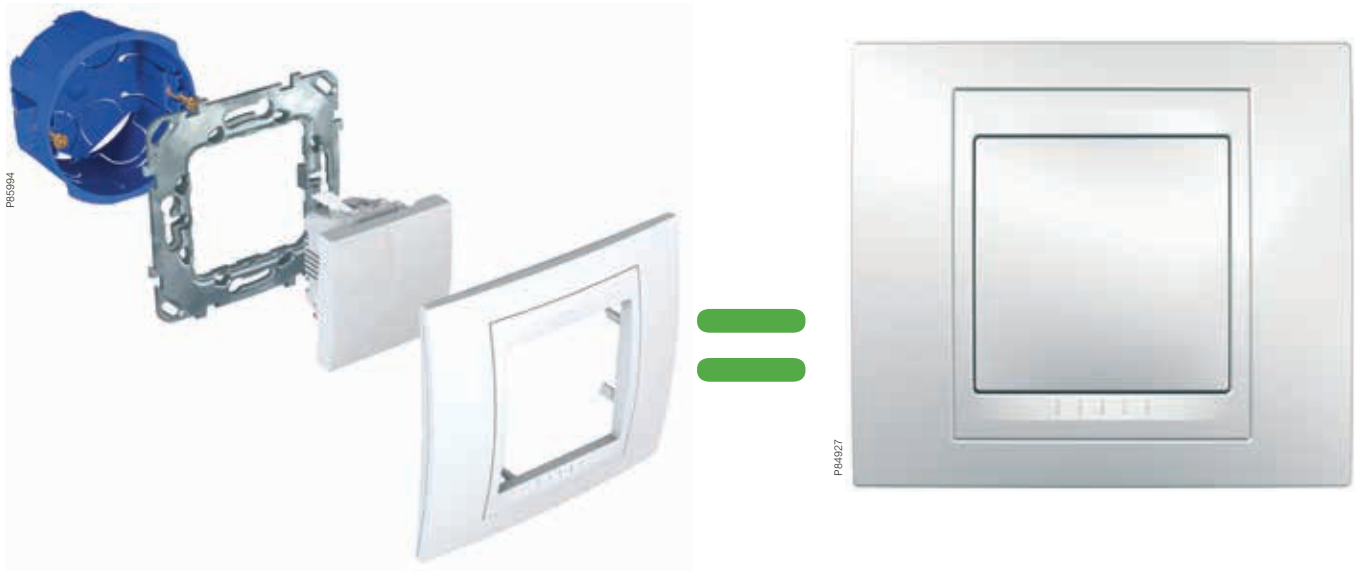

**Flush CE60 boxes**  
Flush installation using individual boxes or multiple horizontal or vertical boxes.

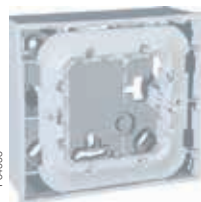

**Surface CE60 boxes**  
Surface individual or multiple boxes for vertical or horizontal installations.



**Universal installation fixing frames**  
Fixing frames in zamak or plastic for screw or claw-mounting.



Zamak without claws



Zamak with short fixed claws

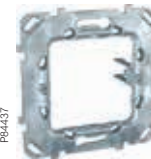

Zamak with long fixed claws

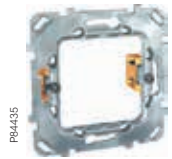

Zamak fixing frame using accessory short claws with protection



Plastic without claws



Plastic with short fixed claws



**Multigang aesthetic cover frames**  
Cover frames for flush or surface installations. Horizontal and vertical versions from 1 to 5 gang.



P87449



P87447



P87448



P104534



## Modular multifunction

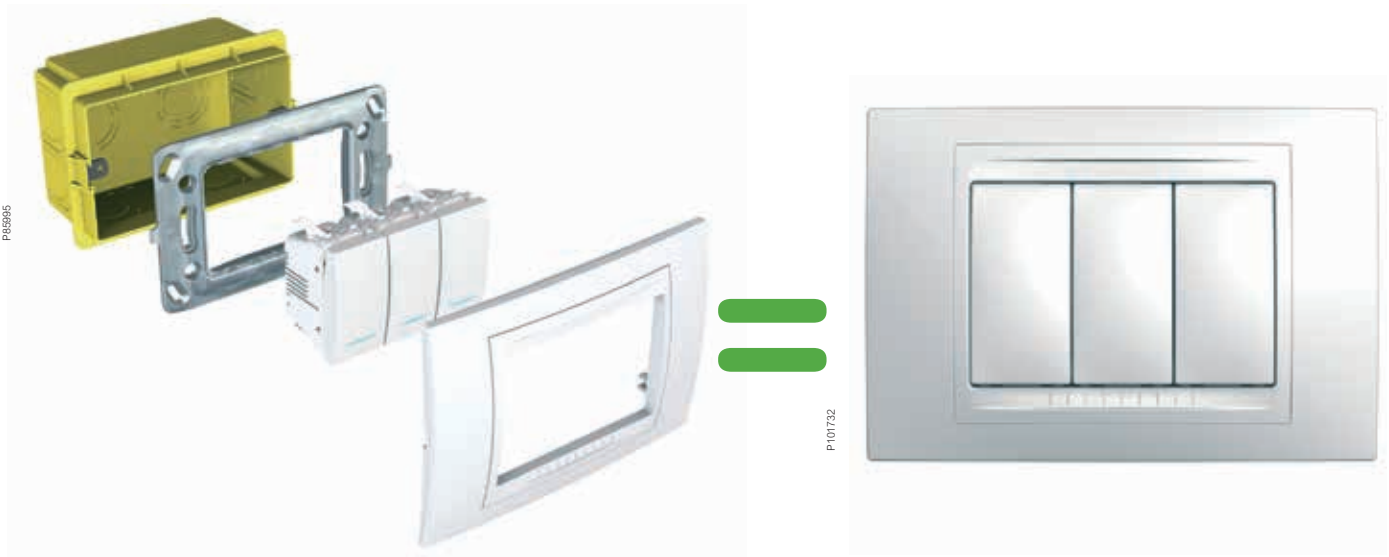

P85695

P101732

P86157



**Flush modular boxes**  
3, 4 and 6 modules.

**Flush modular boxes**  
Centralization  
2 x 4 modules,  
2 x 6 modules .

P84576



P87484

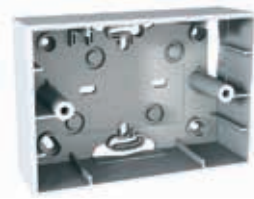

**Surface modular boxes**  
Surface box for 3 and 4  
modules.

P84442

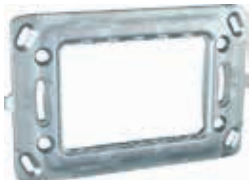

**Multifunction installation fixing frames**  
Zamak fixing frames for screw mounting from 3 to 6 modules and for centralizations from 8 to 12 modules.

P84441



**Multifunction installation fixing frames**  
Plastic fixing frames for screw mounting from 3 to 6 modules and for centralizations from 8 to 12 modules.

P87456



**Multifunction aesthetic cover frames**  
Cover frames for flush or surface installations.

P87455



P87456



P87457



P87458



P83147



P87471



P87472



# The modularity system

## 1-2-3-4-5 gang, 1-12 modules

The Unica range has a large number of interfaces to comfortably use the high functionality of the range.

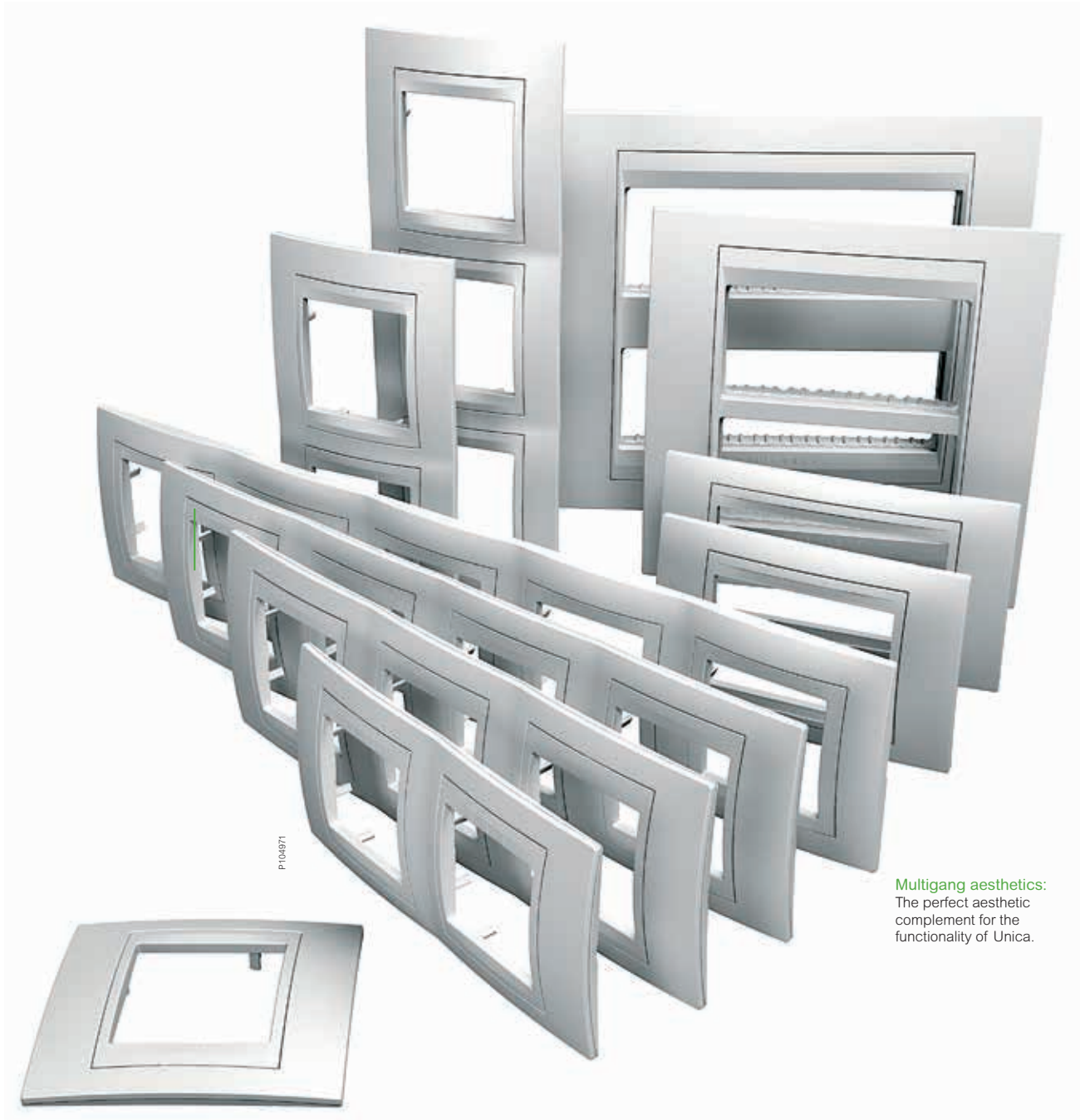

P104971

**Multigang aesthetics:**  
The perfect aesthetic complement for the functionality of Unica.

**Limit your stock:**  
In the Unica Quadro, Unica Colors and Unica Basic ranges, the same cover frames can be fitted either vertically or horizontally.



P105803

**Adaptation to the surrounding space:**  
The cover frames of Unica Quadro, Unica Colors and Unica Basic can be fitted in whatever way suits the available space best.

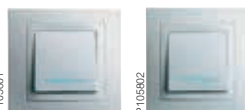

P105801

P105802



P105805

**Centralization:**  
Centralization cover frame, 2 x 4 or 2 x 6 modules, with outlets.



P104160

**Broadest range, more options:**  
The Unica range allows you to combine narrow modules and wide modules in each rectangular box.



P105804

90°

## Installations in detail

Many years of research and experience have enabled us to produce one of the best fixing frames on the market, combining ruggedness and corrosion resistance with ease of use and fitting. Manufactured in zamak or plastic.



Short fixed claws.

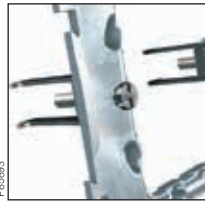

Long fixed claws



Accessory short claws with plastic protection.

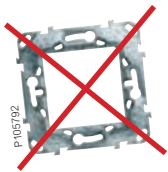

**Always straight:** Easier to align, with a straight supporting surface that makes it easy to use a level.

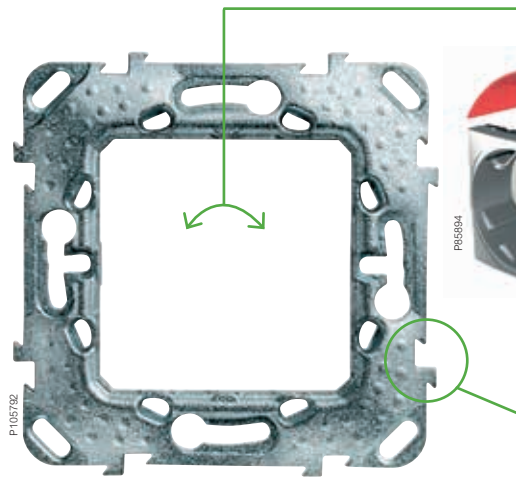

**No sharp edges:** Manufactured in zamak, the fixing frame is rugged and corrosion resistant. As it is not die-cut, there are no sharp edges.



**Simplification:** A single support-frame can be used for 1, 2, 3, 4 or 6 modules as the design allows the mechanism to be fitted in any position.



**No need to think:** Mechanism fixing system with borders on all four sides to ensure maximum flexibility of installation.

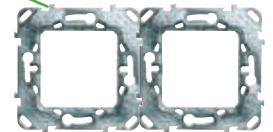

**Easy to fit:** The mounting points and symmetric geometry of the frame assure the possibility to fix horizontally or vertically.

## Aesthetics in detail

The final look of an installation does not depend just on the colour and design of the visible parts. It is also essential that all the parts of a light point go together, that they suit the space in which they are fitted and that they are durable. With Unica all this, and more, is possible.



**Perfectly fitted cover frames**  
The cover frames snap onto the box at four points by means of ratchet-type anchor-pins permitting:

- Precise fixing against irregular walls.
- No hold-ups even though the box stands 0.75 mm out of the wall or is recessed 2.25 mm.

**Always as good as new:** The gloss finish of the insert and cover frames makes them easy to clean. Just wipe with a cloth and they look as good as new. A cloth is also perfect for cleaning the Unica Top wood and metal frames.

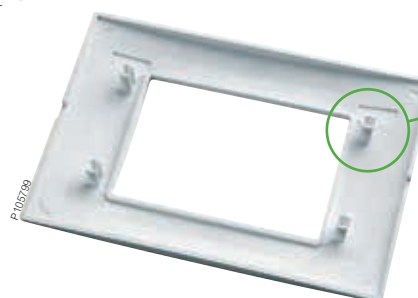
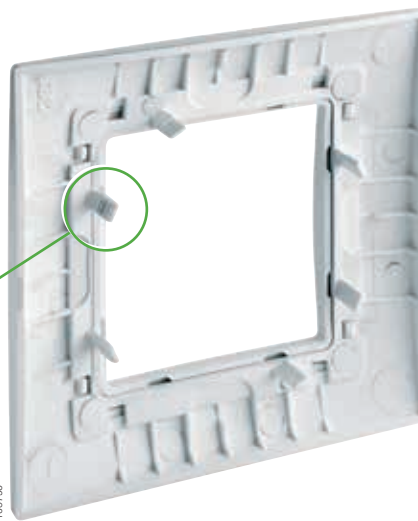

**Designed down to the last detail:** To achieve an aesthetically pleasing design, the curvature of the insert cover frame means that the relief markings on the decorative frame should be parallel to the axis on which the insert pivots.



**Fixing systems suited to all types of cover frames:** In the case of rectangular cover frames, the fixing system used to fit the frame onto the fixing frame is different. The greater fixing strength needed is achieved by using cylindrical ratchet-type anchor-pins rather than flat ones.

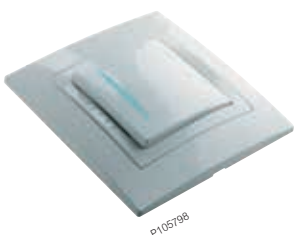

# Technical benefits

## Switches in detail

Reduce installation time by up to 20%

The overall aim of the new Unica wiring devices is to simplify the installer's job. To achieve this we have worked particularly on all the tiny details of installing our control devices.



Screwless terminals with ergonomics release buttons for 1.5 to 2.5 mm<sup>2</sup> for rigid and flexible wire.

Safer wiring thanks to the electrical wiring diagram on back engraved by laser (lower risk of incorrect wiring, better visibility at twilight).



Only terminals needed are open.



In both 10 A (grey) and 16 A (black) switches the terminal connection system is by screws.



Installation details, optimal wire stripping lengths and quality marks are clearly marked on the sides of the devices.



No more wiring up indicator lamps: devices with locator/indicator LED lamps do not need an external indicator as it is already built-in.

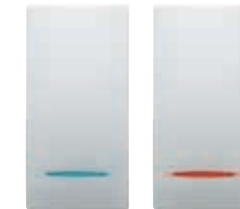

Low consumption LED lamps: no flickering, longer lifetime, brighter light.

## Socket-outlets in detail

Based on our customers' experience as installers, gathered through exhaustive market research, we have developed the fitting and safety features of our socket-outlets to match them to ever stricter productivity and safety requirements.



**At the speed of light:** Two basic features in the design of the socket make it possible to reduce wiring times substantially. Firstly, the alignment of the terminals makes it possible to cut the wires simultaneously, and secondly sockets are supplied with the terminal screws pre-loosened, eliminating a step in installation.

**Childproof:** Sockets are fitted with shutters to prevent children inserting foreign bodies in them. These shuttering units are covered with plastic to avoid any damages.

**Greater safety:** Well dimensioned terminals separated by high walls to avoid short-circuit risk when flexible wires are used.

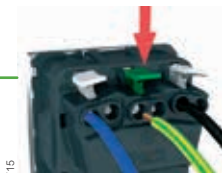
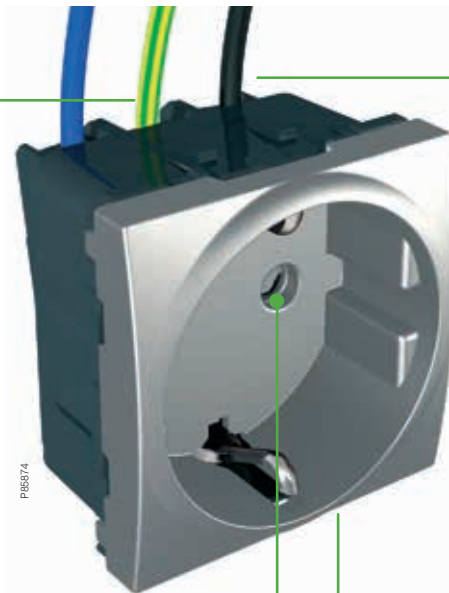

Available in screwless version with easy color code for cabling.

**Centerplate clip in system (no screw):** Pre-clipped delivery form for screw version, already clipped for screwless version.



**Pilot lamp version:** LED is connected as soon as the centerplate is clipped. Possibility to upgrade a simple version to a lamp version with one accessory.

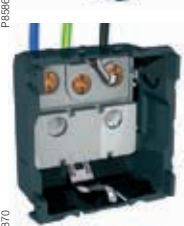

## Data sockets in detail

The new Infraplus and LexCom ranges of RJ45 data sockets guarantee optimal connections and high reliability for voice and data transmission, more than meeting the requirements of cat 5e and cat 6.

**Ease of connection:**  
Cables can be connected without tools to the RJ45 socket by hand. Faster cable termination by clipping.

**Universal connection:**  
Complies with all connection conventions: EIA/TIA 568A, 568B.

**A wide range:**  
RJ45 sockets are available for unshielded, foiled and shielded cables meeting the range requirements necessary for cat 5e and cat 6.

**Precision technology:**  
Connectors designed with dual layer compensation to reduce cross talk between wires and improve attenuation characteristics.

**U-shaped cable entry with a smart bridle:**  
Despite being compact in size, the connector has enough room inside for your work. Both space and functions are designed to ease your installation.

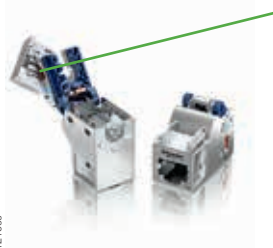

P121600

Innovative U-shaped cable entry and spring-loaded earthing bridle.



P121608

**Automatic 360° earthing**



P121609

**Integrated earth-drain contact to provide double earthing**

**Reliable connections:**  
Internal contacts: IDC technology to make the connection with the copper wire easier.

**Cable organizer:**  
Easy organization of cables and simultaneous connection of the 4 pairs of cables. Cat 5e: green, cat 6: blue shutter cap colour. Using the organizer ensures the untwisted length is less than the minimum set by the standards (<13 mm.) The organizer is colour-coded for error-free connection.



P121603

**Reinforced 360° hood:**  
CFF – Compact Form Factor improves performance and higher flexibility of connector orientation during installation, and ensures the grounding continuity of the installation.

**Protection of the IDC:**  
The IDC are inserted in a plastic cavity, that's why it's impossible put his fingers on the IDC.

**The range is colour-coded:**  
Both shielded and unshielded connectors are coded according to the same system. Dark blue for Cat6A, Light blue for Cat6 and green for Cat5e.

Label holder to identify port number and services.

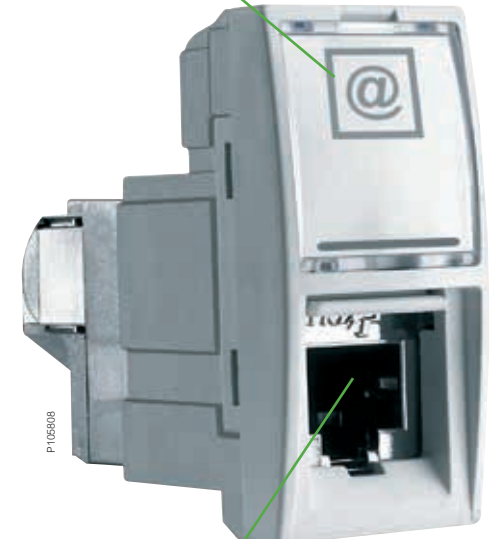

P105909



P105910



P105911

**Dust-protection shutter**

## Electronic inserts in detail

New microelectronics-based technological solutions that allow you to install latest-generation electronic functions with the same ease and simplicity as with an electro-mechanical mechanism.

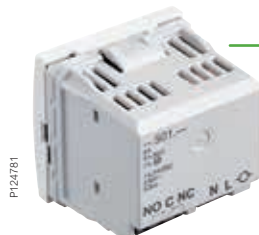

P123781

**Error-free connections**  
All the terminals are clearly marked with symbols to enable error-free wiring. Power terminals and auxiliary terminals are located separately for clarity.



P105769

**Design and ergonomics**  
Maximum attention has been paid to design and ergonomics to ensure they look right in any setting.



P103850

**Vanguard technology**  
Gradual function and totally silent operation thanks to the use of transistor technology.

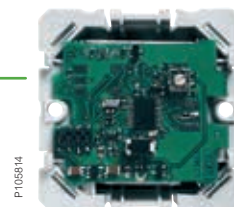

P105914



P105913

P85861

**More features, same depth**  
Electronic inserts have a larger number of terminals than traditional inserts, so there fore they need more cables. This makes the depth of the device a decisive factor in the ease of installation.

**Do less to achieve more**  
Without adding a single cable, a lighting controller can replace a conventional switch, making them quick and easy to retrofit.

# Unica Class Unica Top



## Controls

### 10 AX – 250 V AC switches



|             |  | 10 AX one-way screwless terminals        |             | 10 AX one-way screw terminals            |              |
|-------------|--|--|-------------|--|--------------|
|             |  |  |             |  |              |
| Colour      |  | 2 modules                                | 1 module    | 1 module                                 |              |
| ■ aluminium |  | MGU3.201.30                              | MGU3.101.30 | MGU3.101T.30                             |              |
| ■ graphite  |  | MGU3.201.12                              | MGU3.101.12 |  |              |
|             |  | 10 AX two-way screwless terminals        |             | 10 AX two-way screw terminals            |              |
|             |  |  |             |  |              |
| Colour      |  | 2 modules                                | 1 module    | 2 modules                                | 1 module     |
| ■ aluminium |  | MGU3.203.30                              | MGU3.103.30 | MGU3.203T.30                             | MGU3.103T.30 |
| ■ graphite  |  | MGU3.203.12                              | MGU3.103.12 |  |              |
|             |  | 10 AX intermediate screwless terminals   |             | 10 AX intermediate screw terminals       |              |
|             |  |  |             |  |              |
| Colour      |  | 2 modules                                | 1 module    | 2 modules                                |              |
| ■ aluminium |  | MGU3.205.30                              | MGU3.105.30 | MGU3.205T.30                             |              |
| ■ graphite  |  | MGU3.205.12                              | MGU3.105.12 |  |              |
|             |  | 10 AX double one-way screwless terminals |             | 10 AX double two-way screwless terminals |              |
|             |  |  |             |  |              |
| Colour      |  | 2 modules                                |             | 2 modules                                |              |
| ■ aluminium |  | MGU3.211.30                              |             | MGU3.213.30                              |              |
| ■ graphite  |  | MGU3.211.12                              |             | MGU3.213.12                              |              |
|             |  | With internal power connection           |             | With external power connection           |              |

### 16 AX – 250 V AC switches

|             |  | 16 AX one-way screw terminals |             | 16 AX double pole one-way screw terminals |             |
|-------------|--|-------------------------------|-------------|---|-------------|
|             |  |                               |             |   |             |
| Colour      |  | 2 modules                     | 1 module    | 2 modules                                 | 1 module    |
| ■ aluminium |  | MGU3.261.30                   | MGU3.161.30 | MGU3.262.30                               |             |
| ■ graphite  |  | MGU3.261.12                   | MGU3.161.12 | MGU3.262.12                               | MGU3.162.12 |
|             |  | 16 AX two-way screw terminals |             |   |             |
|             |  |                               |             |   |             |
| Colour      |  | 2 modules                     |             | 1 module                                  |             |
| ■ aluminium |  | MGU3.263.30                   |             | MGU3.163.30                               |             |
| ■ graphite  |  | MGU3.263.12                   |             | MGU3.163.12                               |             |



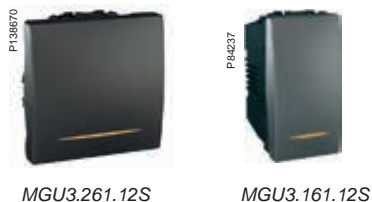
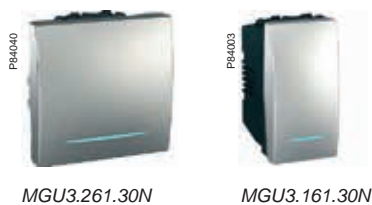
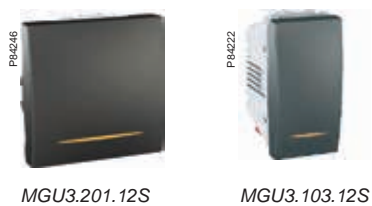
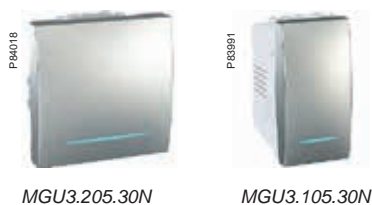
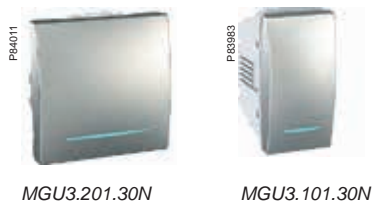

## 10 AX – 250 V AC switches with blue locator lamp

| 10 AX one-way screwless terminals |   | 10 AX one-way screw terminals             |  |
|-----------------------------------|---|---|--|
|                                   |   |   |  |
| Colour                            | ■ 2 modules    ■ 1 module               | ■ 2 modules    ■ 1 module                 |  |
| ■ aluminium                       | <b>MGU3.201.30N</b> <b>MGU3.101.30N</b> | <b>MGU3.201T.30N</b> <b>MGU3.101T.30N</b> |  |
| ■ graphite                        | <b>MGU3.201.12N</b> <b>MGU3.101.12N</b> | <b>MGU3.201T.12N</b>                      |  |

Blue LED lamp, connected internally

| 10 AX two-way screwless terminals |   | 10 AX two-way screw terminals |  |
|-----------------------------------|---|-------------------------------|--|
|                                   |   |                               |  |
| Colour                            | ■ 2 modules    ■ 1 module               | ■ 1 module                    |  |
| ■ aluminium                       | <b>MGU3.203.30N</b> <b>MGU3.103.30N</b> |                               |  |
| ■ graphite                        | <b>MGU3.203.12N</b> <b>MGU3.103.12N</b> | <b>MGU3.103T.12N</b>          |  |

Blue LED lamp, connected internally

| 10 AX intermediate screwless terminals |   | 10 AX intermediate screw terminals |  |
|--|---|------------------------------------|--|
|  |   |                                    |  |
| Colour                                 | ■ 2 modules    ■ 1 module               | ■ 1 module                         |  |
| ■ aluminium                            | <b>MGU3.205.30N</b> <b>MGU3.105.30N</b> | <b>MGU3.105T.30N</b>               |  |
| ■ graphite                             | <b>MGU3.205.12N</b> <b>MGU3.105.12N</b> |                                    |  |

Blue LED lamp, connected internally

## 10 AX – 250 V AC switches with amber indicator lamp

| 10 AX one-way screwless terminals |                     | 10 AX two-way screwless terminals       |  |
|-----------------------------------|---------------------|---|--|
|                                   |                     |   |  |
| Colour                            | ■ 2 modules         | ■ 2 modules    ■ 1 module               |  |
| ■ aluminium                       | <b>MGU3.201.30S</b> | <b>MGU3.203.30S</b> <b>MGU3.103.30S</b> |  |
| ■ graphite                        | <b>MGU3.201.12S</b> | <b>MGU3.203.12S</b> <b>MGU3.103.12S</b> |  |

Amber LED lamp, connected internally

## 16 AX – 250 V AC switches with blue locator lamp

| 16 AX one-way screw terminals |   | 16 AX two-way screw terminals           |  |
|-------------------------------|---|---|--|
|                               |   |   |  |
| Colour                        | ■ 2 modules    ■ 1 module               | ■ 2 modules    ■ 1 module               |  |
| ■ aluminium                   | <b>MGU3.261.30N</b> <b>MGU3.161.30N</b> | <b>MGU3.263.30N</b> <b>MGU3.163.30N</b> |  |
| ■ graphite                    | <b>MGU3.261.12N</b> <b>MGU3.161.12N</b> | <b>MGU3.263.12N</b> <b>MGU3.163.12N</b> |  |

Blue LED lamp, connected internally

## 16 AX – 250 V AC switches with amber indicator lamp

| 16 AX one-way screw terminals |   | 16 AX double pole one-way screw terminals |  |
|-------------------------------|---|---|--|
|                               |   |   |  |
| Colour                        | ■ 2 modules    ■ 1 module               | ■ 2 modules    ■ 1 module                 |  |
| ■ aluminium                   | <b>MGU3.261.30S</b> <b>MGU3.161.30S</b> | <b>MGU3.262.30S</b> <b>MGU3.162.30S</b>   |  |
| ■ graphite                    | <b>MGU3.261.12S</b> <b>MGU3.161.12S</b> | <b>MGU3.262.12S</b> <b>MGU3.162.12S</b>   |  |

Amber LED lamp, connected internally

| 16 AX two-way screw terminals |   |
|-------------------------------|---|
|                               |   |
| Colour                        | ■ 2 modules    ■ 1 module               |
| ■ aluminium                   | <b>MGU3.263.30S</b> <b>MGU3.163.30S</b> |
| ■ graphite                    | <b>MGU3.263.12S</b> <b>MGU3.163.12S</b> |

Amber LED lamp, connected internally



MGU3.206.30



MGU3.106.30



MGU3.206.12C



MGU3.106.12C



MGU3.206.30N



MGU3.106.30N



MGU3.206.12CN



MGU3.106.12CN



MGU3.206.30LN



MGU3.106.30LN

## 10 A – 250 V AC push-buttons

### 10 A screwless terminals

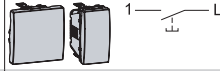

Colour  2 modules  1 module

aluminium MGU3.206.30 MGU3.106.30

graphite MGU3.206.12 MGU3.106.12

### 10 A screw terminals

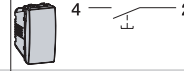

1 module

aluminium MGU3.106T.30

graphite MGU3.106T.12

### 10 A screwless terminals with bell symbol

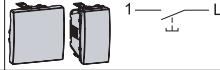

Colour  2 modules  1 module

aluminium MGU3.206.30C MGU3.106.30C

graphite MGU3.206.12C MGU3.106.12C

### 10 A screwless terminals

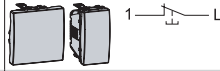

Colour  2 modules  1 module

aluminium MGU3.236.30 MGU3.136.30

graphite MGU3.236.12 MGU3.136.12

### 10 A screwless terminals with light symbol



2 modules  1 module

aluminium MGU3.206.30L MGU3.106.30L

graphite MGU3.206.12L MGU3.106.12L

Normally closed position

## 10 A – 250 V AC push-buttons with blue locator lamp

### 10 A screwless terminals



Colour  2 modules  1 module

aluminium MGU3.206.30N MGU3.106.30N

graphite MGU3.206.12N MGU3.106.12N

### 10 A screw terminals



2 modules  1 module

aluminium MGU3.206T.30N MGU3.106T.30N

graphite MGU3.106T.12N

Blue LED lamp, connected internally

### 10 A screwless terminals with bell symbol

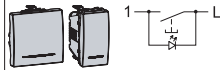

Colour  2 modules  1 module

aluminium MGU3.206.30CN MGU3.106.30CN

graphite MGU3.206.12CN MGU3.106.12CN

Blue LED lamp, connected internally

### 10 A screwless terminals with light symbol



Colour  2 modules  1 module

aluminium MGU3.206.30LN MGU3.106.30LN

graphite MGU3.206.12LN MGU3.106.12LN

Blue LED lamp, connected internally

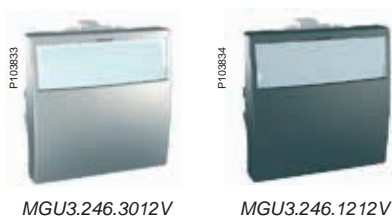

## 10 A – 12 V AC push-buttons

### 10 A screwless terminals with bell symbol

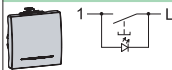

Colour 2 modules

aluminium **MGU3.216.30CN**

graphite

Blue LED lamp, connected internally

### 10 A screwless terminals with illuminated label holder

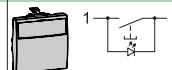

Colour 2 modules

aluminium **MGU3.246.3012V**

graphite **MGU3.246.1212V**

Amber LED lamp, connected internally

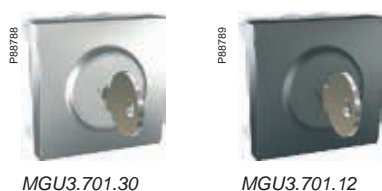

## Key and rotary switches

### Key switch - 2 positions



Colour 2 modules

aluminium **MGU3.701.30**

graphite **MGU3.701.12**

### 40- 3000 W/VA rotary switch - 4 positions

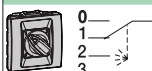

Colour 2 modules

aluminium **MGU3.579.30**

graphite **MGU3.579.12**



## Replacement lamps

### LED for 250 V AC switches and push-buttons with locator/indicator lamp

Colour

amber **MGU0.825.AL**

blue **MGU0.825.AZL**

For switches and push-buttons with screwless terminals from November 2011 (except intermediate switches).

**MGU0.822.AL**

**MGU0.822.AZL**

- Before November 2011, for all switches and push-buttons,
- From November 2011, for switches and push-buttons with screw terminals and intermediate switches.



### LED for 12 V AC push-buttons

Colour

yellow **MGU0.823.AM**



## Specialized controls

### Mechanisms for roller blinds



MGU3.208.30      MGU3.207.12

| 10 A switch screwless  |                    | 10 A push-button screwless |                    |
|--|--------------------|----------------------------|--------------------|
|  |                    |                            |                    |
| Colour   | 2 modules          | Colour                     | 2 modules          |
| ■ aluminium  | <b>MGU3.208.30</b> | ■ aluminium                | <b>MGU3.207.30</b> |
| ■ graphite   | <b>MGU3.208.12</b> | ■ graphite                 | <b>MGU3.207.12</b> |
| With mechanical and electrical safety latching to prevent simultaneous activation in both directions |                    |                            |                    |

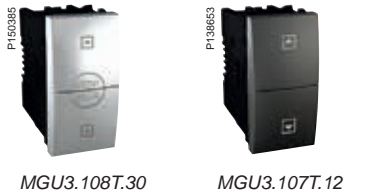

MGU3.108T.30      MGU3.107T.12

| 10 A switch with screw terminals   |                     | 10 A push-button with screw terminals |                     |
|--|---------------------|---------------------------------------|---------------------|
|  |                     |                                       |                     |
| Colour   | 1 module            | Colour                                | 1 module            |
| ■ aluminium  | <b>MGU3.108T.30</b> | ■ aluminium                           | <b>MGU3.107T.30</b> |
| ■ graphite   | <b>MGU3.108T.12</b> | ■ graphite                            | <b>MGU3.107T.12</b> |
| With mechanical and electrical safety latching to prevent simultaneous activation in both directions |                     |                                       |                     |

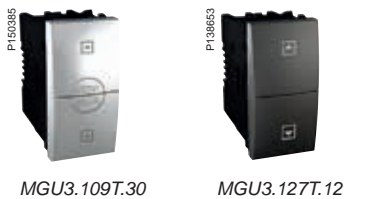

MGU3.109T.30      MGU3.127T.12

| 10 AX double pole switch with screw terminals  |                     | 10 AX double pole push-button with screw terminals |                     |
|--|---------------------|--|---------------------|
|  |                     |  |                     |
| Colour   | 1 module            | Colour   | 1 module            |
| ■ aluminium  | <b>MGU3.109T.30</b> | ■ aluminium  | <b>MGU3.127T.30</b> |
| ■ graphite   | <b>MGU3.109T.12</b> | ■ graphite   | <b>MGU3.127T.12</b> |
| With mechanical and electrical safety latching to prevent simultaneous activation in both directions |                     |  |                     |

### Mechanisms for VMC

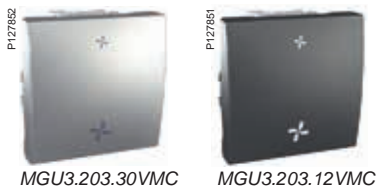

MGU3.203.30VMC      MGU3.203.12VMC

| VMC speed switch |                       |
|------------------|-----------------------|
|                  |                       |
| Colour           | 2 modules             |
| ■ aluminium      | <b>MGU3.203.30VMC</b> |
| ■ graphite       | <b>MGU3.203.12VMC</b> |



MGU3.214.30      MGU3.214.12

| VMC two speed and ON/OFF switch |                    |
|---------------------------------|--------------------|
|                                 |                    |
| Colour                          | 2 modules          |
| ■ aluminium                     | <b>MGU3.214.30</b> |
| ■ graphite                      | <b>MGU3.214.12</b> |

### Cord push-button



MGU3.226.30      MGU3.226.12

| 250 V with pull   |                    |
|-------------------|--------------------|
|                   |                    |
| Colour            | 2 modules          |
| ■ aluminium       | <b>MGU3.226.30</b> |
| ■ graphite        | <b>MGU3.226.12</b> |
| Cable length: 1 m |                    |



MGU3.224.30



MGU3.231.30



MGU3.224.30S



MGU3.232.30S



MGU3.232.12S

## 20 A – 250 V high rating switches

### 20 AX double pole one-way

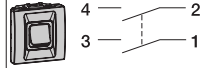

|             |                    |
|-------------|--------------------|
| Colour      | 2 modules          |
| ■ aluminium | <b>MGU3.224.30</b> |

## 32 A – 250 V high rating switches

### 32 A (25 AX) one-way

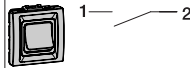

|             |                    |
|-------------|--------------------|
| Colour      | 2 modules          |
| ■ aluminium | <b>MGU3.231.30</b> |
| ■ graphite  | <b>MGU3.231.12</b> |

## 20 AX – 250 V high rating switch with amber indicator lamp

### 20 AX double pole one-way

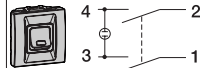

|             |                     |
|-------------|---------------------|
| Colour      | 2 modules           |
| ■ aluminium | <b>MGU3.224.30S</b> |

Amber neon lamp, connected internally

## 32 AX – 250 V high rating switch with amber indicator lamp

### 32 AX double pole one-way

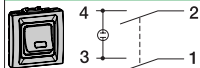

|             |                     |
|-------------|---------------------|
| Colour      | 2 modules           |
| ■ aluminium | <b>MGU3.232.30S</b> |
| ■ graphite  | <b>MGU3.232.12S</b> |

Amber neon lamp, connected internally



MGU3.630.30



MGU3.631.30

## Protection

### Fuse holders

#### 10 A



Colour 1 module

■ aluminium **MGU3.630.30**

For cylindrical fuses up to 10 A with dimensions 6x32 mm

#### 16 A



Colour 2 modules

■ aluminium **MGU3.631.30**

■ graphite **MGU 3.631.12**

For 00 type fuses

## Comfort controls

### Rotary electronic dimmers switches

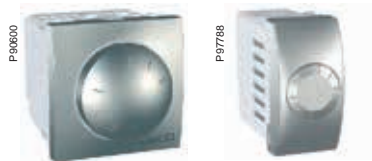

MGU3.511.30

MGU3.559.30



MGU3.510.12

MGU5.512.30ZD



MGU3.515.30

#### 40-400 W/VA one/two way switch



|             |                    |                    |
|-------------|--------------------|--------------------|
| Colour      | 2 modules          | 1 module           |
| ■ aluminium | <b>MGU3.511.30</b> | <b>MGU3.559.30</b> |
| ■ graphite  | <b>MGU3.511.12</b> | <b>MGU3.559.12</b> |

- One pulse to switch on (or off) and rotation to regulate load

#### 400 VA, 1-10 V for fluorescent tubes



|             |                    |                      |
|-------------|--------------------|----------------------|
| Colour      | 2 modules          | 2 modules            |
| ■ aluminium | <b>MGU3.510.30</b> | <b>MGU5.512.30ZD</b> |
| ■ graphite  | <b>MGU3.510.12</b> | <b>MGU5.512.12ZD</b> |

- Max. control current: 200 mA
- Compliant with the interference suppression (EMC) standard EN 60669-2-1
- 4-wire connection
- Compliant with the interference suppression (EMC) standard EN 60669-2-1
- 3-wire connection

### Push-button dimmer switch

#### Multi-load Variapush (pulse control) 20-350 W/VA



|             |                    |
|-------------|--------------------|
| Colour      | 2 modules          |
| ■ aluminium | <b>MGU3.515.30</b> |
| ■ graphite  | <b>MGU3.515.12</b> |

Compliant with the interference suppression (EMC) standard EN 60669-2-1

| MGU3.511.XX | MGU3.559.XX | MGU3.510.XX      | MGU5.512.XX | MGU3.515.XX | Load table   |
|-------------|-------------|------------------|-------------|-------------|--|
| 400 W       | 400 W       |                  | 1000 W      | 250 W       | <b>Maximum loads</b>   |
| 400 W       | 400 W       |                  | 1000 W      | 350 W       | 230 V AC incandescent lamps  |
| 400 VA      |             |                  | 1000 VA     | 350 VA      | 230 V AC halogen lamps   |
|             |             |                  |             | 300 VA      | ELV halogen lamps with ferromagnetic transformer (non toroidal)  |
|             |             |                  |             | 350 VA      | ELV lamps with toroidal transformer  |
|             |             | 400 VA<br>1-10 V |             |             | <ul style="list-style-type: none"> <li>• 230 V AC fluorescent tube, <math>\Phi</math> 26 or <math>\Phi</math> 38 mm with 1-10 V electronic ballast</li> <li>• 230 V AC fluorescent tube, 36 W with 10 electronic ballasts (1-10 V)</li> <li>• 230 V AC fluorescent tube, 2 x 16 W, <math>\Phi</math> 26 or <math>\Phi</math> 30 mm with 5 electronic ballasts (1-10 V)</li> <li>• Maximum control of 50 electronic ballasts (1-10 V) with an external relay</li> </ul> |
|             |             |                  |             | 200 W       | 230 V AC fans  |
|             |             |                  |             | 350 W       | 230 V AC convectors  |
|             |             |                  | 600 W       |             | 230 V AC motors  |
|             |             |                  |             |             | <b>Installation</b>  |
|             |             |                  |             |             | Installed in place of a switch   |
|             |             |                  |             |             | May be controlled by push-buttons: up to 25 push-buttons in the surrounding area   |

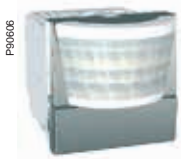

MGU3.524.30

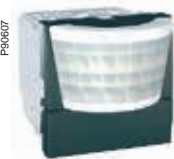

MGU3.525.12

## Movement and presence detectors

|             | 300 W detector     | 2300 W detector    |
|-------------|--------------------|--------------------|
|             |                    |                    |
| Colour      | ■ 2 modules        | ■ 2 modules        |
| ■ aluminium | <b>MGU3.524.30</b> | <b>MGU3.525.30</b> |
| ■ graphite  | <b>MGU3.524.12</b> | <b>MGU3.525.12</b> |

- Adjustable disconnection time and brightness
- Optional switching of the load connected to the control switch using conventional auxiliary push-buttons

|                                  |                                   | Load table  |  |
|----------------------------------|-----------------------------------|---|--|
| MGU3.524.XX                      | MGU3.525.XX                       |   |  |
|                                  |                                   | <b>Maximum loads</b>  |  |
| 300 W                            | 2300 W                            |   | 230 V AC incandescent lamps                                  |
| 300 W                            | 2000 W                            |   | 230 V AC halogen lamps                                       |
|                                  | 1050 VA                           |   | ELV halogen lamps with wire-wound transformer (non toroidal) |
|                                  | 1150 VA                           |   | ELV halogen lamps with electronic transformer                |
|                                  | 2000 VA<br>cos $\varphi \geq 0,9$ |   | 230 V AC fluorescent tubes $\Phi$ 26 or $\Phi$ 38 mm         |
|                                  | 500 VA                            |   | 230 V AC compact fluorescent lamps                           |
|                                  | 200 VA                            |   | 230 V AC fans  |
| 300 W<br>cos $\varphi \geq 0.95$ | 2300 W                            |   | 230 V AC convectors  |
|                                  | 200 VA                            |   | 230 V AC contactors  |
|                                  |                                   | <b>Installation</b>   |  |
|                                  |                                   | Parallel connection: max. 2 detectors for a load                  |  |
|                                  |                                   | Possibility of using up to 5 push-buttons in the surrounding area |  |





MGU3.501.30



MGU3.505.12



MGU3.503.30



MGU3.535.30



MGU3.541.30

## Thermostats

### 8 A basic thermostat



|             |                    |                    |
|-------------|--------------------|--------------------|
| Colour      | 2 modules          | 2 modules          |
| ■ aluminium | <b>MGU3.501.30</b> | <b>MGU3.505.30</b> |
| ■ graphite  | <b>MGU3.501.12</b> | <b>MGU3.505.12</b> |

Used to control heating and air conditioning according to pre-programmed times and temperatures

### 10 A floor thermostat



|             |                    |
|-------------|--------------------|
| Colour      |                    |
| ■ aluminium | <b>MGU3.503.30</b> |
| ■ graphite  | <b>MGU3.503.12</b> |

Delivered with 4 m temperature sensor

## Time delay switch

### 8 A press activated time delay switch



|             |                    |
|-------------|--------------------|
| Colour      | 2 modules          |
| ■ aluminium | <b>MGU3.535.30</b> |
| ■ graphite  | <b>MGU3.535.12</b> |

- For all load types
- Adjustable disconnection time (2 s - 12 min.)
- Optional switching on using conventional push-button
- Included night blue locator lamp

## Weekly programmable timer

### Weekly programmable



|             |                    |
|-------------|--------------------|
| Colour      | 2 modules          |
| ■ aluminium | <b>MGU3.541.30</b> |
| ■ graphite  | <b>MGU3.541.12</b> |

- 230 V 1200 W (incandescent and halogen)
- 1000 VA (halogen 12 V with electromagnetic transformer)
- 28 intervals



MGU3.546.30



MGU3.545.30



MGU3.540.30



MGU3.283.12



MGU0.824



MGU3.710.30



MGU3.711.12



MGU3.713.30



MGU3.712



MGU3.716.12

## Weatherstation

### Weatherstation



|             |                    |
|-------------|--------------------|
| Colour      | 2 modules          |
| ■ aluminium | <b>MGU3.546.30</b> |
| ■ graphite  | <b>MGU3.546.12</b> |

- Ambient temperature
- Atmospheric pressure
- Relative humidity

## Wake up clock

### Wake up clock



|             |                    |
|-------------|--------------------|
| Colour      | 2 modules          |
| ■ aluminium | <b>MGU3.545.30</b> |
| ■ graphite  | <b>MGU3.545.12</b> |

- Double alarm
- "SNOOZE" function
- Indication of ambient temperature

## Key card switches

### 8 A timed

for Unica Top

for Unica Class

### 10 A

for Unica Top

for Unica Class



|             |                    |                      |                    |                      |
|-------------|--------------------|----------------------|--------------------|----------------------|
| Colour      | 2 modules          | 2 modules            | 2 modules          | 2 modules            |
| ■ aluminium | <b>MGU3.540.30</b> | <b>MGU3.540.30CS</b> | <b>MGU3.283.30</b> | <b>MGU3.283.30CS</b> |
| ■ graphite  | <b>MGU3.540.12</b> | <b>MGU3.540.12CS</b> | <b>MGU3.283.12</b> | <b>MGU3.283.12CS</b> |

With locator lamp

### Supplementary lamp for key card switch



**MGU0.824**

## Technical alarms

### Detectors

#### Methane gas detectors - 12 V AC/DC



|             |                    |
|-------------|--------------------|
| Colour      | 2 modules          |
| ■ aluminium | <b>MGU3.710.30</b> |
| ■ graphite  | <b>MGU3.710.12</b> |

#### LPG gas detectors - 12 V AC/DC



|             |                    |
|-------------|--------------------|
| Colour      | 2 modules          |
| ■ aluminium | <b>MGU3.711.30</b> |
| ■ graphite  | <b>MGU3.711.12</b> |

#### Flood detectors - 12 V AC/DC



|             |                    |
|-------------|--------------------|
| Colour      | 2 modules          |
| ■ aluminium | <b>MGU3.713.30</b> |
| ■ graphite  | <b>MGU3.713.12</b> |

#### Sensor for flood detectors



|             |                         |
|-------------|-------------------------|
| Colour      | 2 modules               |
| ■ aluminium | <b>MGU3.712 (white)</b> |
| ■ graphite  |                         |

## Power supplies

### 230 V AC/ 12 V AC - 50/60 Hz



|             |                    |
|-------------|--------------------|
| Colour      | 2 modules          |
| ■ aluminium | <b>MGU3.716.30</b> |
| ■ graphite  | <b>MGU3.716.12</b> |



MGU3.057.30

MGU3.057.12TA



MGU3.057.30SL



MGU3.036.30



MGU3.036.12



MGU3.037.30

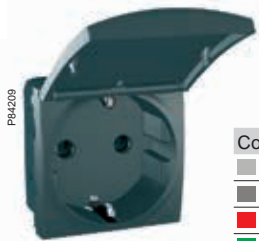

MGU3.037.12TA



MGU3.040.30



MGU3.040.12

## Socket-outlets

### German socket-outlets

#### 16 A 2P + E, shuttered, screwless



#### 16 A 2P + E, shuttered, screwless, hinged flap



|           |             |               |
|-----------|-------------|---------------|
| Colour    | 2 modules   | 2 modules     |
| aluminium | MGU3.057.30 | MGU3.057.30TA |
| graphite  | MGU3.057.12 | MGU3.057.12TA |
| red       | MGU3.057.03 |               |
| green     | MGU3.057.06 |               |

Side earth

#### 16 A 2P + E, shuttered, screwless with lamp



|           |               |
|-----------|---------------|
| Colour    | 2 modules     |
| aluminium | MGU3.057.30SL |
| graphite  |               |
| red       | MGU3.057.03SL |

Side earth

#### 16 A 2P + E, screw terminals



|           |             |
|-----------|-------------|
| Colour    | 2 modules   |
| aluminium | MGU3.036.30 |
| graphite  | MGU3.036.12 |

Side earth

#### 16 A 2P + E, shuttered, screw terminals



#### 16 A 2P + E, shuttered, screw terminals, hinged flap



|           |             |               |
|-----------|-------------|---------------|
| Colour    | 2 modules   | 2 modules     |
| aluminium | MGU3.037.30 | MGU3.037.30TA |
| graphite  | MGU3.037.12 | MGU3.037.12TA |
| red       | MGU3.037.03 |               |
| green     | MGU3.037.06 |               |
| orange    | MGU3.037.61 |               |

Side earth

#### 16 A 2P + E, shuttered, screw terminals with lamp



|           |               |
|-----------|---------------|
| Colour    | 2 modules     |
| aluminium | MGU3.037.30SL |
| graphite  | MGU3.037.12SL |
| red       | MGU3.037.03SL |

Side earth

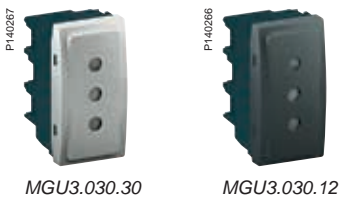
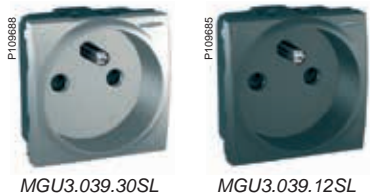

## French socket-outlets

### 16 A 2P + E, shuttered, screwless



Colour 2 modules

aluminium **MGU3.059.30**

graphite **MGU3.059.12**

Pin earth

### 16 A 2P + E, shuttered, screwless with lamp



Colour 2 modules

red **MGU3.059.03SL**

Pin earth

### 16 A 2P + E, shuttered, screw terminals



Colour 2 modules

aluminium **MGU3.039.30**

graphite **MGU3.039.12**

red **MGU3.039.03**

Pin earth

### 16 A 2P + E, shuttered, screw terminals with lamp



Colour 2 modules

aluminium **MGU3.039.30SL**

graphite **MGU3.039.12SL**

red **MGU3.039.03SL**

Pin earth

## Italian socket-outlets

### 10 A 2P, Italian earth, shuttered, screw terminals



Colour 1 module

aluminium **MGU3.030.30**

graphite **MGU3.030.12**

### 16 A 2P, Italian earth, shuttered, screw terminals



Colour 1 module

aluminium **MGU3.023.30**

graphite **MGU3.023.12**

## British socket-outlets

### 13 A 2P + E, shuttered, screw terminals



Colour 2 modules

aluminium **MGU3.045.30**

graphite **MGU3.045.12**

### 15 A 2P + E, shuttered, screw terminals



Colour 2 modules

**MGU3.046.30**

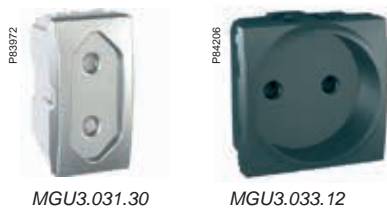
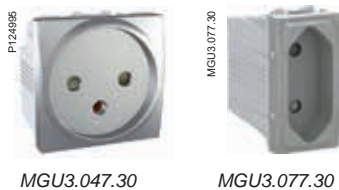

## Special socket-outlet

| 16 A 2P + E, shuttered, screw terminals |                    | 10 A 2P, shuttered, screw terminals |  |
|---|--------------------|-------------------------------------|--|
|   |                    |                                     |  |
| Colour                                  | 2 modules          | 1 module                            |  |
| ■ aluminium                             | <b>MGU3.047.30</b> | <b>MGU3.077.30</b>                  |  |
| ■ graphite                              | <b>MGU3.047.12</b> | <b>MGU3.077.12</b>                  |  |
| ■ red                                   | <b>MGU3.047.03</b> |                                     |  |

## European socket-outlets

| 10 A 2P, shuttered, screw terminals                                   |                    | 16 A 2P, shuttered, screw terminals |  |
|---|--------------------|-------------------------------------|--|
|   |                    |                                     |  |
| Colour  | 1 module           | 2 modules                           |  |
| ■ aluminium   | <b>MGU3.031.30</b> | <b>MGU3.033.30</b>                  |  |
| ■ graphite  | <b>MGU3.031.12</b> | <b>MGU3.033.12</b>                  |  |
| Only for replacements in installations without an earthing connection |                    | Only for replacements               |  |

## Euroamerican socket-outlets

| 2P, shuttered, screw terminals  |                    |                                    |  |
|---|--------------------|------------------------------------|--|
|   |                    |                                    |  |
| Colour  | 1 module           |                                    |  |
| ■ aluminium   | <b>MGU3.021.30</b> |                                    |  |
| ■ graphite  | <b>MGU3.021.12</b> |                                    |  |
| <ul style="list-style-type: none"> <li>• 10 A - 250V AC for cylindrical pins</li> <li>• 15 A - 125V AC for flat pins</li> </ul> |                    |                                    |  |
| 2P + E, screw terminals   |                    | 2P + E, shuttered, screw terminals |  |
|   |                    |                                    |  |
| Colour  | 2 modules          | 2 modules                          |  |
| ■ aluminium   | <b>MGU3.041.30</b> | <b>MGU3.048.30</b>                 |  |
| ■ graphite  | <b>MGU3.041.12</b> |                                    |  |
| <ul style="list-style-type: none"> <li>• 10 A - 250V AC for cylindrical pins</li> <li>• 15 A - 125V AC for flat pins</li> </ul> |                    |                                    |  |
| 2P + E, shuttered, screw terminals  |                    |                                    |  |
|   |                    |                                    |  |
| Colour  | 3 modules          |                                    |  |
| ■ aluminium   | <b>MGU3.068.30</b> |                                    |  |
| <ul style="list-style-type: none"> <li>• 10 A - 250V AC for cylindrical pins</li> <li>• 15 A - 125V AC for flat pins</li> </ul> |                    |                                    |  |
| 20 VA shaver socket, screw terminals  |                    |                                    |  |
|   |                    |                                    |  |
| Colour  | 3 modules          |                                    |  |
| ■ aluminium   | <b>MGU5.064.30</b> |                                    |  |
| Input: 240 V, output: 115/240 V, 50 or 60 Hz, for shaver only   |                    |                                    |  |



## American socket-outlets

15 A 2P + E, screw terminals



15 A 2P + E, shuttered, screw terminals

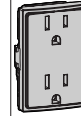

Colour  
 ■ aluminium  
 ■ graphite

1 module  
 ■ MGU3.028.30  
 ■ MGU3.028.12

3 modules  
 ■ MGU3.061.30  
 ■ MGU3.061.12



## Socket-outlet centerplate with lamp

For french socket-outlet



Colour  
 ■ aluminium  
 ■ graphite

2 modules  
 ■ MGU0.839.30  
 ■ MGU0.839.12

## Data sockets

### RJ45 data sockets



MGU3.411.30

MGU3.410.12

|             |  | Category 5e, unshielded              |                                   | Category 5e, shielded              |                                   |
|-------------|--|--------------------------------------|-----------------------------------|------------------------------------|-----------------------------------|
|             |  |                                      |                                   |                                    |                                   |
| Colour      |  | 2 modules                            | 1 module                          | 2 modules                          | 1 module                          |
| ■ aluminium |  | <b>MGU3.411.30</b> <sup>(1)</sup>    | <b>MGU3.410.30</b> <sup>(1)</sup> | <b>MGU3.413.30</b> <sup>(2)</sup>  | <b>MGU3.412.30</b> <sup>(2)</sup> |
| ■ graphite  |  | <b>MGU3.411.12</b> <sup>(1)</sup>    | <b>MGU3.410.12</b> <sup>(1)</sup> | <b>MGU3.413.12</b> <sup>(2)</sup>  | <b>MGU3.412.12</b> <sup>(2)</sup> |
| Colour      |  |                                      | 1 module                          | 2 modules                          | 1 module                          |
| ■ aluminium |  |                                      | <b>MGU3.420.30</b> <sup>(1)</sup> | <b>MGU3.423.30</b> <sup>(2)</sup>  | <b>MGU3.422.30</b> <sup>(2)</sup> |
| ■ graphite  |  |                                      | <b>MGU3.420.12</b> <sup>(1)</sup> | <b>MGU3.423.12</b> <sup>(2)</sup>  | <b>MGU3.422.12</b> <sup>(2)</sup> |
|             |  | Category 6, unshielded               |                                   | Category 6, shielded               |                                   |
|             |  |                                      |                                   |                                    |                                   |
| Colour      |  | 2 modules                            | 1 module                          | 2 modules                          | 1 module                          |
| ■ aluminium |  | <b>MGU3.415.30</b> <sup>(3)</sup>    | <b>MGU3.414.30</b> <sup>(3)</sup> | <b>MGU3.417.30</b> <sup>(4)</sup>  | <b>MGU3.416.30</b> <sup>(4)</sup> |
| ■ graphite  |  | <b>MGU3.415.12</b> <sup>(3)</sup>    | <b>MGU3.414.12</b> <sup>(3)</sup> | <b>MGU3.417.12</b> <sup>(4)</sup>  | <b>MGU3.416.12</b> <sup>(4)</sup> |
| Colour      |  | 2 modules                            | 1 module                          | 2 modules                          | 1 module                          |
| ■ aluminium |  | <b>MGU3.425.30</b> <sup>(3)</sup>    | <b>MGU3.424.30</b> <sup>(3)</sup> | <b>MGU3.427.30</b> <sup>(4)</sup>  | <b>MGU3.426.30</b> <sup>(4)</sup> |
| ■ graphite  |  | <b>MGU3.425.12</b> <sup>(3)</sup>    | <b>MGU3.424.12</b> <sup>(3)</sup> | <b>MGU3.427.12</b> <sup>(4)</sup>  | <b>MGU3.426.12</b> <sup>(4)</sup> |
|             |  | Category 6 <sub>A</sub> , unshielded |                                   | Category 6 <sub>A</sub> , shielded |                                   |
|             |  |                                      |                                   |                                    |                                   |
| Colour      |  | 2 modules                            | 1 module                          | 2 modules                          | 1 module                          |
| ■ aluminium |  | <b>MGU3.445.30</b> <sup>(5)</sup>    | <b>MGU3.444.30</b> <sup>(5)</sup> | <b>MGU3.447.30</b> <sup>(6)</sup>  | <b>MGU3.446.30</b> <sup>(6)</sup> |
| ■ graphite  |  | <b>MGU3.445.12</b> <sup>(5)</sup>    | <b>MGU3.444.12</b> <sup>(5)</sup> | <b>MGU3.447.12</b> <sup>(6)</sup>  | <b>MGU3.446.12</b> <sup>(6)</sup> |

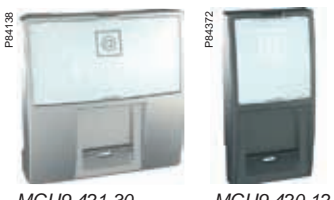

MGU9.421.30

MGU9.420.12

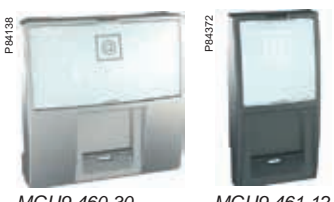

MGU9.460.30

MGU9.461.12

### RJ45 data connector covers

|             |  | LexCom             |                    | Infraplus          |                    |
|-------------|--|--------------------|--------------------|--------------------|--------------------|
|             |  |                    |                    |                    |                    |
| Colour      |  | 2 modules          | 1 module           | 2 modules          | 1 module           |
| ■ aluminium |  | <b>MGU9.421.30</b> | <b>MGU9.420.30</b> | <b>MGU9.411.30</b> | <b>MGU9.410.30</b> |
| ■ graphite  |  | <b>MGU9.421.12</b> | <b>MGU9.420.12</b> | <b>MGU9.411.12</b> | <b>MGU9.410.12</b> |
|             |  | Universal          |                    |                    |                    |
|             |  |                    |                    |                    |                    |
| Colour      |  | 2 modules          | 1 module           |                    |                    |
| ■ aluminium |  | <b>MGU9.460.30</b> | <b>MGU9.461.30</b> |                    |                    |
| ■ graphite  |  | <b>MGU9.460.12</b> | <b>MGU9.461.12</b> |                    |                    |

See technical information pages for compatibility table

Actassi S-one RJ45 connectors reference numbers included into Unica data sockets:

<sup>(1)</sup> VDIB17725U, <sup>(2)</sup> VDIB17725B, <sup>(3)</sup> VDIB17726U, <sup>(4)</sup> VDIB17726B, <sup>(5)</sup> VDIB1772XU, <sup>(6)</sup> VDIB1772XB.



VDIB17725U

VDIB17725B

VDIB17726U

VDIB17726B

VDIB1772XU

VDIB1772XB

## Optical fibre center plates

### Common characteristics

- Ambient air temperature for operation: 5 to 35 °C
- Standard: IEC 60874
- Degree of protection: IP20/ IK04.

### SC/SC APC duplex type



Colour

■ aluminium

**MGU9.438.30**

- Support to receive any SC simplex and duplex adapters
- Support to receive **Actassy** optical fibre adapters:
  - SC Duplex multi mode adapters: ref. n° VDIB6031001 and VDIB6031002
  - SC Duplex single mode adapters: ref. n° VDIB6032001 and VDIB6032002
  - SC APC Duplex single mode adapter: ref. n° VDIB6082001
  - SC APC Simplex single mode adapter: ref. n° VDIB6072001.



MGU9.438.30



VDIB6031001  
VDIB6031002



VDIB6032001  
VDIB6032002



VDIB6082001



VDIB6072001





MGU3.451.30

MGU3.451.12

## TV/FM/SAT sockets

### TV/FM sockets

#### TV/FM socket for parallel distribution systems



|             |   |  |
|-------------|---|--|
| Colour      | 2 modules   | 2 modules  |
| ■ aluminium | <b>MGU3.451.30</b>  | <b>MGU3.469.30</b>   |
| ■ graphite  | <b>MGU3.451.12</b>  | <b>MGU3.469.12</b>   |
|             | <ul style="list-style-type: none"> <li>• 47-860 MHz</li> <li>• Individual socket</li> </ul> | <ul style="list-style-type: none"> <li>• 47-860 MHz</li> <li>• Individual socket with galvanic insulation</li> </ul> |

#### TV/FM sockets for series distribution systems



|             |   |  |
|-------------|---|--|
| Colour      | 2 modules   | 2 modules  |
| ■ aluminium | <b>MGU3.452.30</b>  | <b>MGU3.453.30</b>   |
| ■ graphite  | <b>MGU3.452.12</b>  | <b>MGU3.453.12</b>   |
|             | <ul style="list-style-type: none"> <li>• 47-860 MHz</li> <li>• End-of-line (terminal socket)</li> </ul> | <ul style="list-style-type: none"> <li>• 47-860 MHz</li> <li>• Intermediate socket (passage socket)</li> </ul> |



MGU3.454.30

MGU3.454.12

### R-TV/SAT sockets

#### R-TV/SAT socket for parallel distribution systems



|             |  |   |
|-------------|--|---|
| Colour      | 2 modules  | 2 modules   |
| ■ aluminium | <b>MGU3.454.30</b>   | <b>MGU3.455.30</b>  |
| ■ graphite  | <b>MGU3.454.12</b>   | <b>MGU3.455.12</b>  |
|             | <ul style="list-style-type: none"> <li>• 10-2400 MHz</li> <li>• Individual socket</li> </ul> | <ul style="list-style-type: none"> <li>• 10-2400 MHz</li> <li>• End-of-line (terminal)</li> </ul> |

#### R-TV/SAT socket for series distribution systems



|             |  |
|-------------|--|
| Colour      | 2 modules  |
| ■ aluminium | <b>MGU3.456.30</b>   |
| ■ graphite  | <b>MGU3.456.12</b>   |
|             | <ul style="list-style-type: none"> <li>• 10-2400 MHz</li> <li>• Intermediate socket (passage)</li> </ul> |



MGU3.450.30

MGU3.450.12

### R/TV/SAT sockets

#### R/TV/SAT socket for parallel distribution systems



|             |   |
|-------------|---|
| Colour      | 2 modules   |
| ■ aluminium | <b>MGU3.450.30</b>  |
| ■ graphite  | <b>MGU3.450.12</b>  |
|             | <ul style="list-style-type: none"> <li>• R: 5-108 MHz / TV: 125-862 MHz / SAT: 950-2400 MHz</li> <li>• Individual socket</li> </ul> |

### TV/SAT sockets

#### TV/SAT Female socket-F type



|             |                    |
|-------------|--------------------|
| Colour      | 1 module           |
| ■ aluminium | <b>MGU3.468.30</b> |
| ■ graphite  | <b>MGU3.468.12</b> |





MGU3.468.30

MGU3.468.12



## SAT single shielded sockets



|             | Male individual   | Male terminal   |
|-------------|---|---|
|             |  |  |
| Colour      | ■ 2 modules   | ■ 2 modules   |
| ■ aluminium | <b>MGU3.462.30</b>  | <b>MGU3.464.30</b>  |
| ■ graphite  | <b>MGU3.462.12</b>  | <b>MGU3.464.12</b>  |
|             | 5-2150 MHz  |   |

### Male passage

|             |   |
|-------------|---|
|             |  |
| Colour      | ■ 2 modules   |
| ■ aluminium | <b>MGU3.463.30</b>  |
| ■ graphite  | <b>MGU3.463.12</b>  |
|             | 5-2150 MHz  |



## TV single shielded sockets



|             | Female individual   | Female terminal   |
|-------------|---|---|
|             |  |  |
| Colour      | ■ 2 modules   | ■ 2 modules   |
| ■ aluminium | <b>MGU3.465.30</b>  | <b>MGU3.467.30</b>  |
| ■ graphite  | <b>MGU3.465.12</b>  | <b>MGU3.467.12</b>  |
|             | 5-862 MHz   |   |

### Female passage

|             |   |
|-------------|---|
|             |  |
| Colour      | ■ 2 modules   |
| ■ aluminium | <b>MGU3.466.30</b>  |
| ■ graphite  | <b>MGU3.466.12</b>  |
|             | 5-862 MHz   |



## TV/FM/SAT cover plates

|             | TV/FM   | R-TV/SAT  |
|-------------|---|---|
|             |  |  |
| Colour      | ■ 2 modules   | ■ 2 modules   |
| ■ aluminium | <b>MGU9.440.30</b>  | <b>MGU9.441.30</b>  |
| ■ graphite  | <b>MGU9.440.12</b>  | <b>MGU9.441.12</b>  |



MGU3.492.30



MGU3.490.12



MGU3.497.30



MGU3.491.12



MGU3.499.30



MGU3.499.12



MGU3.498.30



MGU3.498.12



MGU3.775.30A



MGU3.775.30R



MGU3.775.12V



MGU3.775.12T



MGU0.821

## Telephone sockets

### RJ11 and RJ12

Screw connection. As per RD 1/1998 and RD 279/1999 (ICT): socket for the Terminal Access Database (TAD) for the telephony service.

#### RJ11- 4 contacts screw



|           |             |             |
|-----------|-------------|-------------|
| Colour    | 2 modules   | 1 module    |
| aluminium | MGU3.492.30 | MGU3.490.30 |
| graphite  | MGU3.492.12 | MGU3.490.12 |

#### RJ12- 6 contacts screwless

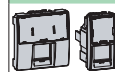

|           |             |             |
|-----------|-------------|-------------|
| Colour    | 2 modules   | 1 module    |
| aluminium | MGU3.493.30 | MGU3.495.30 |
| graphite  | MGU3.493.12 | MGU3.495.12 |

#### RJ12- 6 contacts screw



|           |             |             |
|-----------|-------------|-------------|
| Colour    | 2 modules   | 1 module    |
| aluminium | MGU3.497.30 | MGU3.491.30 |
| graphite  | MGU3.497.12 | MGU3.491.12 |

## British telephone sockets

### 6 contacts screwless



|           |             |
|-----------|-------------|
| Colour    | 1 module    |
| aluminium | MGU3.499.30 |
| graphite  | MGU3.499.12 |

## Belgian telephone sockets

### Belgacom type



|           |             |
|-----------|-------------|
| Colour    | 2 modules   |
| aluminium | MGU3.498.30 |
| graphite  | MGU3.498.12 |

## Indication

### Indicator lamps

#### Orange



|           |              |
|-----------|--------------|
| Colour    | 1 module     |
| aluminium | MGU3.775.30A |
| graphite  | MGU3.775.12A |

#### Red



|           |              |
|-----------|--------------|
| Colour    | 1 module     |
| aluminium | MGU3.775.30R |
| graphite  | MGU3.775.12R |

#### Green



|           |              |
|-----------|--------------|
| Colour    | 1 module     |
| aluminium | MGU3.775.30V |
| graphite  | MGU3.775.12V |

#### Colourless



|           |              |
|-----------|--------------|
| Colour    | 1 module     |
| aluminium | MGU3.775.30T |
| graphite  | MGU3.775.12T |

### Neon lamp for indicator lamp



MGU0.821

## Multimedia sockets

### USB data connectors



MGU3.429.30

| USB data connector  |                    |
|---|--------------------|
| Colour  | 1 module           |
| ■ aluminium   | <b>MGU3.429.30</b> |
| ■ graphite  | <b>MGU3.429.12</b> |
| <ul style="list-style-type: none"> <li>• Output connectors: USB 2.0</li> <li>• Connection: screw terminals</li> <li>• Clamping connection capacity: up to 1.5 mm<sup>2</sup> rigid/stranded/flexible</li> <li>• Ambient air temperature for operation: - 5°C to + 40°C</li> <li>• Standards: IEC 998-1, IEC 998-2-1</li> <li>• Protection degrees: IP21/IK04</li> </ul> |                    |

### HDMI sockets



MGU3.430.30

| HDMI prewired socket   |                    |
|--|--------------------|
| Colour   | 1 module           |
| ■ aluminium  | <b>MGU3.430.30</b> |
| ■ graphite   | <b>MGU3.430.12</b> |
| <ul style="list-style-type: none"> <li>• Ambient air temperature for operation: - 5°C to + 40°C</li> <li>• Standards: EN 50157, EN 50049</li> <li>• Protection degrees: IP21/IK04</li> </ul> |                    |

### RCA sockets



MGU3.431.30

| 3 RCA female socket  |                    |
|--|--------------------|
| Colour   | 1 module           |
| ■ aluminium  | <b>MGU3.431.30</b> |
| ■ graphite   | <b>MGU3.431.12</b> |
| <ul style="list-style-type: none"> <li>• Connection: screw terminals</li> <li>• Clamping connection capacity: up to 1.5 mm<sup>2</sup> rigid/stranded/flexible</li> <li>• Ambient air temperature for operation: - 5°C to + 40°C</li> <li>• Protection degrees: IP21/IK04</li> </ul> |                    |

### HD15 sockets



MGU3.432.30

| HD15 female socket  |                    |
|---|--------------------|
| Colour  | 1 module           |
| ■ aluminium   | <b>MGU3.432.30</b> |
| ■ graphite  | <b>MGU3.432.12</b> |
| <ul style="list-style-type: none"> <li>• Ambient air temperature for operation: - 5°C to + 40°C</li> <li>• Protection degrees: IP21/IK04</li> </ul> |                    |

### Mini jack sockets



MGU3.433.30

| Mini jack 3.5 mm socket   |                    |
|---|--------------------|
| Colour  | 1 module           |
| ■ aluminium   | <b>MGU3.433.30</b> |
| ■ graphite  | <b>MGU3.433.12</b> |
| <ul style="list-style-type: none"> <li>• Ambient air temperature for operation: - 5°C to + 40°C</li> <li>• Protection degrees: IP21/IK04</li> </ul> |                    |



MGU70.567.30



MGU70.566.30



MGU70.598



MGU3.486.30



MGU3.487.12



MGU3.428.30



MGU3.418.30



MGU3.418.12

## Bluetooth audio receivers

|             | In-wall bluetooth audio receiver   | In-wall bluetooth audio receiver kit   |
|-------------|--|--|
| Colour      |  |  |
| ■ aluminium | <b>MGU70.567.30</b>  | <b>MGU70.566.30</b>  |
| ■ graphite  | <b>MGU70.567.12</b>  | <b>MGU70.566.12</b>  |
|             | Delivered with: <ul style="list-style-type: none"> <li>• audio receiver device</li> <li>• power supply</li> </ul>                              | Delivered with: <ul style="list-style-type: none"> <li>• audio receiver device</li> <li>• power supply</li> <li>• 2 loudspeakers</li> <li>• fixing frame with adaptor</li> </ul> |
|             | <b>Characteristics:</b> <ul style="list-style-type: none"> <li>• Audio receiver</li> <li>○ 2 modules</li> <li>○ voltage: 15-16 V DC</li> </ul> | <ul style="list-style-type: none"> <li>• Power supply</li> <li>○ voltage: 93-265 V AC</li> <li>○ frequency: 47-63 Hz</li> </ul>  |

## Loudspeakers and accessories

### Loudspeakers 2.5"

#### MGU70.598

- 2 loudspeakers delivered with 2 cables (5 m,  $\Phi$  0.5 mm<sup>2</sup>, red and white)
- Dimensions (diameter x depth): 95 mm x 36 mm
- Impedance: 8  $\Omega$

### Loudspeaker socket

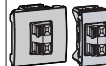

| Colour      | 2 modules          | 1 module           |
|-------------|--------------------|--------------------|
| ■ aluminium | <b>MGU3.486.30</b> | <b>MGU3.487.30</b> |
| ■ graphite  | <b>MGU3.486.12</b> | <b>MGU3.487.12</b> |

Pressure-fixing of terminals

## USB chargers

### Single USB

| Colour      | 1 module           |
|-------------|--------------------|
| ■ aluminium | <b>MGU3.428.30</b> |
| ■ graphite  | <b>MGU3.428.12</b> |

- Nominal input voltage: 100-240 V AC  $\pm$ 10 %
- USB output voltage: 5 V DC  $\pm$  5 %
- Nominal output current: 1 A
- Power consumption: < 0.1 W (in stand-by)
- Maximum output power: 7.5 W
- Overvoltage category: OVC III
- Isolation class: class II



### Double USB charger 2.1 A

| Colour      | 2 modules          |
|-------------|--------------------|
| ■ aluminium | <b>MGU3.418.30</b> |
| ■ graphite  | <b>MGU3.418.12</b> |

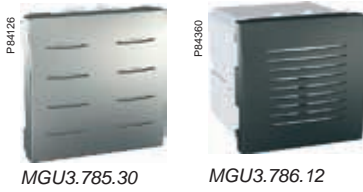
- Nominal input voltage: 100-240 V AC  $\pm$ 10 %
- USB output voltage: 5 V DC  $\pm$  5 %
- Nominal output current: 1 x 2.1 A (only left output) or 2 x 1.05 A (for 2 outputs)
- Power consumption: < 0.1 W (in stand-by)
- Maximum output power: 10.5 W
- Expected lifetime: 30 000 h for output power 10.5 W
- Overvoltage category: OVC III
- Isolation class: class II



## Buzzer and electronic doorbell

|                                    | 230 V, 50-60Hz buzzer   | 230 V electronic doorbell   |
|------------------------------------|---|---|
|                                    |  |  |
| Colour                             | <input type="checkbox"/> 2 modules  | <input type="checkbox"/> 2 modules  |
| <input type="checkbox"/> aluminium | <b>MGU3.785.30</b>  | <b>MGU3.786.30</b>  |
| <input type="checkbox"/> graphite  | <b>MGU3.785.12</b>  | <b>MGU3.786.12</b>  |
|                                    | With adjustable tone  | 5 tunes   |



## Emergency light

| Emergency light |   |
|-----------------|---|
|                 |  |
|                 | <input type="checkbox"/> 2 modules  |
|                 | <b>MGU3.776.T</b>   |



## Pilotlamp

| Autonomous pilotlamp |   |
|----------------------|---|
|                      |  |
|                      | <input type="checkbox"/> 2 modules  |
|                      | <b>MGU3.780.T</b>   |

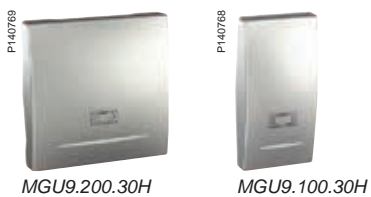
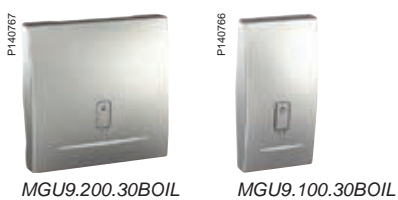
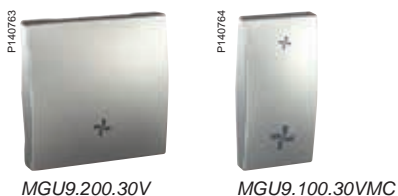
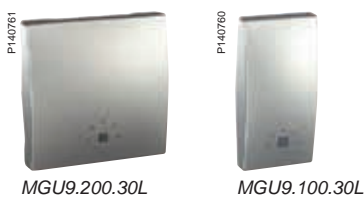
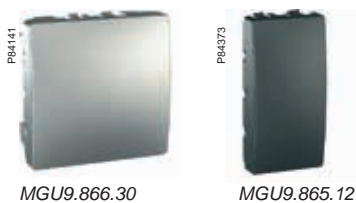
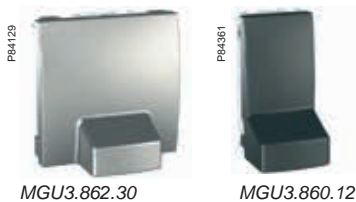

## Complementary offers

### Cable outlet

#### 16 A

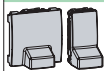

| Colour    | 2 modules          | 1 module           |
|-----------|--------------------|--------------------|
| aluminium | <b>MGU3.862.30</b> | <b>MGU3.860.30</b> |
| graphite  | <b>MGU3.862.12</b> | <b>MGU3.860.12</b> |

- 3 x 2.5mm<sup>2</sup> connection terminals
- Anti-tug clamps

### Blind cover plates

#### Blind cover plate



| Colour    | 2 modules          | 1 module           | 1/2 module         |
|-----------|--------------------|--------------------|--------------------|
| aluminium | <b>MGU9.866.30</b> | <b>MGU9.865.30</b> | <b>MGU9.864.30</b> |
| graphite  | <b>MGU9.866.12</b> | <b>MGU9.865.12</b> | <b>MGU9.864.12</b> |

#### Blind cover plate with groove



| Colour    | 1 module           |
|-----------|--------------------|
| aluminium | <b>MGU9.868.30</b> |

### Rockers

#### Rocker with light symbol



| Colour    | 2 modules           | 1 module            |
|-----------|---------------------|---------------------|
| aluminium | <b>MGU9.200.30L</b> | <b>MGU9.100.30L</b> |
| graphite  | <b>MGU9.200.12L</b> | <b>MGU9.100.12L</b> |

#### Rocker with fan symbol



| Colour    | 1 module            | 2 modules           | 1 module              |
|-----------|---------------------|---------------------|-----------------------|
| aluminium | <b>MGU9.200.30V</b> | <b>MGU9.100.30V</b> | <b>MGU9.100.30VMC</b> |
| graphite  | <b>MGU9.200.12V</b> | <b>MGU9.100.12V</b> | <b>MGU9.100.12VMC</b> |

#### Rocker with 2 speeds fan symbol



| Colour    | 2 modules             | 1 module              |
|-----------|-----------------------|-----------------------|
| aluminium | <b>MGU9.200.30VMC</b> | <b>MGU9.100.30VMC</b> |
| graphite  | <b>MGU9.200.12VMC</b> | <b>MGU9.100.12VMC</b> |

#### Rocker with boiler symbol



| Colour    | 2 modules              | 1 module               |
|-----------|------------------------|------------------------|
| aluminium | <b>MGU9.200.30BOIL</b> | <b>MGU9.100.30BOIL</b> |
| graphite  | <b>MGU9.200.12BOIL</b> | <b>MGU9.100.12BOIL</b> |

#### Rocker with heater symbol



| Colour    | 2 modules           | 1 module            |
|-----------|---------------------|---------------------|
| aluminium | <b>MGU9.200.30H</b> | <b>MGU9.100.30H</b> |
| graphite  | <b>MGU9.200.12H</b> | <b>MGU9.100.12H</b> |



MGU86.071.30



P104955

## Emitters

### Battery powered push-button

For Unica Top cover frames

For Unica Class cover frames

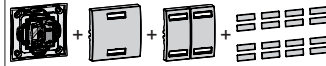

| Colour     | For Unica Top cover frames | For Unica Class cover frames |
|------------|----------------------------|------------------------------|
| ■ alu      | <b>MGU86.071.30</b>        | <b>MGU88.071.30</b>          |
| ■ graphite | <b>MGU86.071.12</b>        | <b>MGU88.071.12</b>          |

- Can control wireless receivers for light and/or roller blinds
- Supplied with a lithium battery, 1 large rocker, 2 narrow rockers and a set of symbols
- Flat fixing frame integrated to the product

## Combined modules

### Combined relay (on/off)

With neutral



| Colour     | For Unica Top cover frames | For Unica Class cover frames |
|------------|----------------------------|------------------------------|
| ■ alu      | <b>MGU3.572.30</b>         |                              |
| ■ graphite | <b>MGU3.572.12</b>         |                              |

- Supplied with 1 large rocker and 2 narrow rockers
- Wireless receiver and emitter in one single product

### Combined dimmer

Without neutral



| Colour     | For Unica Top cover frames | For Unica Class cover frames |
|------------|----------------------------|------------------------------|
| ■ alu      | <b>MGU3.573.30</b>         |                              |
| ■ graphite | <b>MGU3.573.12</b>         |                              |

- Supplied with 1 large rocker and 2 narrow rockers
- Wireless receiver and emitter in one single product

### Combined roller blind

With neutral

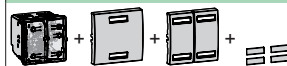

| Colour     | For Unica Top cover frames | For Unica Class cover frames |
|------------|----------------------------|------------------------------|
| ■ alu      | <b>MGU3.574.30</b>         |                              |
| ■ graphite | <b>MGU3.574.12</b>         |                              |

- Supplied with 1 large rocker and 2 narrow rockers
- Wireless receiver and emitter in one single product



MGU3.572.30



P104955



MGU3.573.30

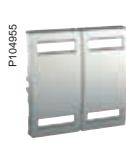

P104955



MGU3.574.30



P104955

## Combined modules load table

| MGU3.572.XX | MGU3.573.XX | MGU3.574.XX | Loads  |
|-------------|-------------|-------------|--|
| 2300 W      | 20 - 315 W  |             | 230 V AC incandescent lamps  |
| 2000 W      | 20 - 315 W  |             | 230 V AC halogen lamps   |
| 500 VA      | 20 - 315 VA |             | 230 V/12 V AC halogen lamps with ferromagnetic transformer (non toroidal)<br>230 V/12 V AC halogen lamps with electronic transformer |
| 500 VA      | 20 - 270 VA |             | 230 V/12 V AC halogen lamps with toroidal transformer  |
| 920 VA      |             |             | 230 V AC fluorescent tubes $\Phi$ 28 or $\Phi$ 38 mm (48 $\mu$ F)  |
| 880 VA      |             |             | 230 V AC compact fluorescent lamps   |
| 880 W       |             |             | 230 V AC LED lamps   |
| 690 VA      |             |             | 230 V AC single phase motors and ventilators   |
|             |             | 690 W       | 230 V AC single phase tubular motors for roller blind (with or without limit switches)   |



## Receivers

### Mobile socket-outlets relay (on/off)

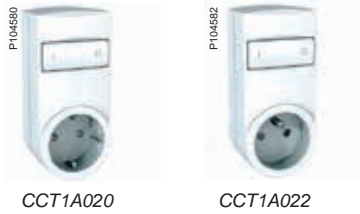



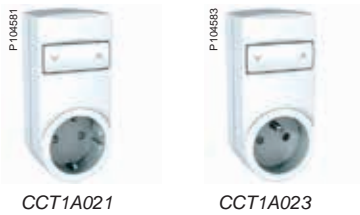





|        | German type mobile socket-outlet        | French type mobile socket-outlet |
|--------|---|----------------------------------|
| Colour | <input type="checkbox"/> white          | <input type="checkbox"/> white   |
|        | <b>CCT1A020</b>                         | <b>CCT1A022</b>                  |
|        | With one key for local control (switch) |                                  |

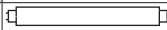

### Mobile socket-outlets dimmer

|        | German type mobile socket-outlet        | French type mobile socket-outlet |
|--------|---|----------------------------------|
| Colour | <input type="checkbox"/> white          | <input type="checkbox"/> white   |
|        | <b>CCT1A021</b>                         | <b>CCT1A023</b>                  |
|        | With one key for local control (dimmer) |                                  |

### Mobile socket-outlets load table

|                        | <br><b>CCT1A020</b><br><b>CCT1A022</b> | <br><b>CCT1A021</b><br><b>CCT1A023</b> | Loads  |
|------------------------|---|---|--|
| 2300 W                 | 250 W   |   |  230 V AC incandescent lamps and halogen lamps  |
| 1840 VA                | 250 VA  |   |  230/12 V AC halogen lamps with ferromagnetic transformer (non toroidal) or with electronic transformer |
| 1840 VA<br>cos φ ≥ 0,9 |   |   |  230 V AC fluorescent tubes Φ 28 or Φ 38 mm (100 μF)  |
| 1840 VA                |   |   |  230 V AC compact fluorescent lamps   |
| 1840 W                 |   |   |  230 V AC LED lamps   |
| 1380 W                 |   |   |  230 V AC motors, ventilators   |



CCT1A000



CCT1A010



CCT1A030



CCT1A031

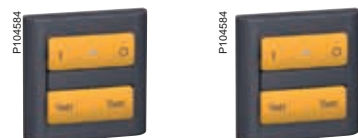

CCT1A090



MGU0.570.30

## Remote controls

### Metal remote control

#### 8 keys to be customized



|        |   |
|--------|---|
| Colour | <input checked="" type="checkbox"/> dark grey   |
|        | <b>CCT1A000</b>   |
|        | <ul style="list-style-type: none"> <li>• Can control lights or/and roller blinds</li> <li>• 8 keys to program in simple mode and scenario mode</li> <li>• Supplied with 2 AAA batteries and 32 symbols</li> </ul> |

### Keyring remote control

#### 4 keys



|        |  |
|--------|--|
| Colour | <input checked="" type="checkbox"/> dark grey  |
|        | <b>CCT1A010</b>  |
|        | <ul style="list-style-type: none"> <li>• 4 keys to control lights and/or roller blinds</li> <li>• Convenient design to be used as a keyring or to be placed in a pocket</li> <li>• Supplied with Lithium CR2032 batteries</li> </ul> |

## Complementary offer

### Universal modules

#### Universal emitter



|                                |  |
|--------------------------------|--|
| <input type="checkbox"/> white | <b>CCT1A030</b>  |
|                                | <ul style="list-style-type: none"> <li>• Converts mechanical push-button into a wireless emitter</li> <li>• 4 RF channels</li> <li>• Supplied with a lithium battery</li> <li>• Never use switches, only push-buttons</li> </ul> |

#### Universal receiver relay



|  |  |
|--|--|
| <input checked="" type="checkbox"/> grey | <b>CCT1A031</b>  |
|  | <ul style="list-style-type: none"> <li>• Flush mounted or hidden in the ceiling</li> <li>• Light: 10 A max.</li> <li>• Engine: 3 A max.</li> </ul> |

### Test kit

#### RF signal tester

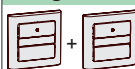

|   |  |
|---|--|
| <input checked="" type="checkbox"/> dark grey | <b>CCT1A090</b>  |
|   | Kit content : 2 testers to check the quality of the RF signal transmission between two product locations |

### Accessories

#### Set of scenario symbols

|        |  |
|--------|--|
| Colour | <input checked="" type="checkbox"/> alu  |
|        | <b>MGU0.570.30</b>   |
|        | <input checked="" type="checkbox"/> graphite   |
|        | <b>MGU0.570.12</b>   |
|        | Set content: 2x cooking, 2x diner, 2x little light, 2x much light, 2x at home, 2x leaving home, 2x TV, 2x empty. |

The following Unica control devices have to be connected to KNX bus line.

The KNX bus line is laid in parallel to the 230 V power supply.

When Unica sensor is activated (for example, a push-button), an actuator (e.g. the roller shutter control) will carry out all the switching commands required.

## Introduction

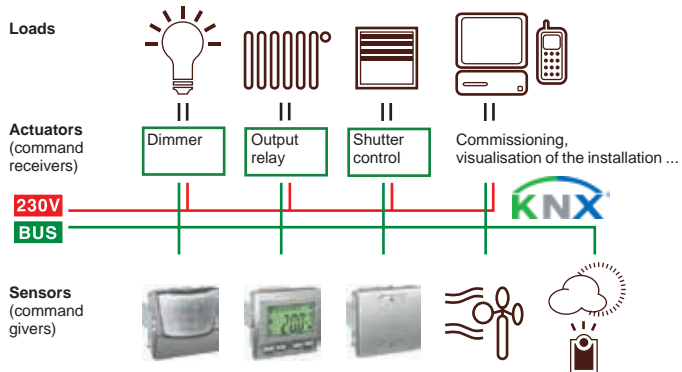

## Controls

### Push-buttons

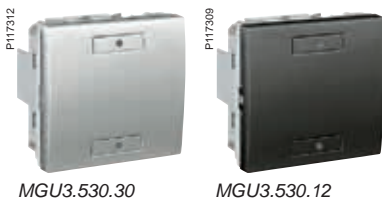

MGU3.530.30

MGU3.530.12



MGU3.531.30

MGU3.531.12

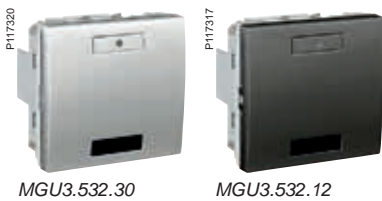

MGU3.532.30

MGU3.532.12



MTN570222

### 2 buttons and 2 blue status LEDs, with screwless bus connecting terminals



Colour  2 modules

aluminium

graphite

**MGU3.530.30**

**MGU3.530.12**

- The status LED is located under the symbol window which can be taken off.
- With integrated bus coupler. The bus is connected using a bus connecting terminal.

#### Contents:

- With set of 10 symbols:
  - 2x symbol with light opening,
  - 1x symbol "1",
  - 1x symbol "0",
  - 2x symbol for dimming,
  - 2x symbol for shutter,
  - 2x symbol (neutral).
- With bus connecting terminal.

### 4 buttons and 4 blue status LEDs, with screwless bus connecting terminals



Colour  2 modules

aluminium

graphite

**MGU3.531.30**

**MGU3.531.12**

- The status LED is located under the symbol window which can be taken off.
- With integrated bus coupler. The bus is connected using a bus connecting terminal.

#### Contents:

- With set of 20 symbols:
  - 4x symbol with light opening,
  - 2x symbol "1",
  - 2x symbol "0",
  - 4x symbol for dimming,
  - 4x symbol for shutter,
  - 4x symbol (neutral).
- With bus connecting terminal.

**KNX software functions:** Switching, toggling, dimming (single/dual-surface), blind (single/dual-surface), pulse edges trigger 1-, 2-, 4- or 8-bit telegrams (distinction between short and long operation), pulse edges with 2-byte telegrams (distinction between short and long operation), 8-bit linear regulator, scene retrieval, scene saving, disable functions.

### 2 buttons, blue status LED and Infra Red (IR) receiver, with screwless bus connecting terminals



Colour  2 modules

aluminium

graphite

**MGU3.532.30**

**MGU3.532.12**

- The status LED is located under the symbol window which can be taken off. The functions of each of the button can be triggered using an IR remote control. The push-button is pre-programmed for operation with a Schneider-Electric IR remote control Distance. Many other IR remote controls (e.g. existing TV or CD player remote controls) can be taught into the push-buttons.

- With integrated bus coupler. The bus is connected using a bus connecting terminal.
- Transmitter: IR remote control Distance, ref. MTN570222.
- Contents: With bus connecting terminal.

**KNX software functions:** Switching, toggling, dimming (single/dual-surface), blind (single/dual-surface), pulse edges trigger 1-, 2-, 4- or 8-bit telegrams (distinction between short and long operation), pulse edges with 2-byte telegrams (distinction between short and long operation), 8-bit linear regulator, scene retrieval, scene saving, disable functions.

### Infra Red (IR) remote control for IR push-button receiver



Colour

black

**MTN570222**

- 10-channel IR remote control
- Battery: 2 microcells (IEC LR 03, AAA)
- Range: up to 20 m
- Contents: without battery.

## Comfort controls



### Movement detector, with screwless bus connecting terminals



|             |                    |
|-------------|--------------------|
| Colour      | 2 modules          |
| ■ aluminium | <b>MGU3.533.30</b> |
| ■ graphite  | <b>MGU3.533.12</b> |

When a movement is detected, a data telegram defined by the programming is transmitted.

- Two movement sensors: the sensitivity and range can be set separately for each sensor
- Detection angle: 180°
- Installation height : 1 m to 2.5 m
- Detection area at 2.15 m mounting height : Approx. 9 m on all sides, adjustable in 10 steps (rotary switch or ETS)
- Detection brightness: Infinite setting from approx. 10 lux to approx. 1000 lux (rotary switch) or from 10 lux to 2000 lux (ETS)
- Overshoot time: Adjustable in 6 steps from approx. 1 s to approx. 8 min (rotary switch) or adjustable from 1 s to 255 hours (ETS)
- EC guidelines: Low-voltage guideline 2006/95/EEC and EMC guideline 2004/108/EC
- With bus connecting terminal. The bus is connected using a bus connecting terminal.

**KNX software functions:** 5 movement blocks: up to 4 functions can be triggered per block.  
Telegrams: 1 bit, 1 byte, 2 bytes.

### Room temperature control unit, with screwless bus connecting terminals



|             |                    |
|-------------|--------------------|
| Colour      | 2 modules          |
| ■ aluminium | <b>MGU3.534.30</b> |
| ■ graphite  | <b>MGU3.534.12</b> |

- With display and 4 buttons
  - 2-step control, continuous PI controller, switching PI controller (PWM)
  - Output: continuous in the range 0 to 100% or switching On/Off
  - Controller mode:
    - Heating with one controller output
    - Cooling with one controller output
    - Heating and cooling with separate controller outputs
    - Heating and cooling with one controller output
    - 2-step heating with 2 control outputs
    - 2-step cooling with 2 control outputs
    - 2-step heating and cooling with 4 control outputs
  - Operating modes: Comfort, comfort extension, standby, night reduction, frost/heat protection
- Move all setpoints, save all setpoint temperatures and operating modes when reset, external temperature monitoring, additional output of the control value as 1 byte value on the PWM.  
With bus connecting terminal. The bus is connected using a bus connecting terminal.

For more information on functions and products in association with KNX, go to Schneider Electric KNX catalogue.



MGU7.002



MGU7.004.P

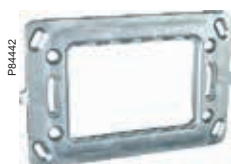

MGU7.103

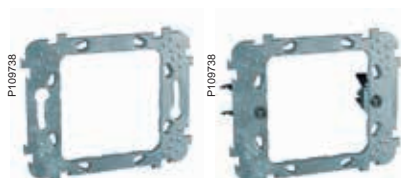

MGU7.012

MGU7.012.GL

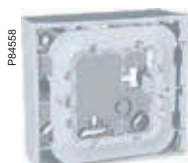

MGU8.022.58



MGU8.624



MGU8.603



MGU8.601

### Universal fixing frames

#### Fixing frame without claws



|         |                   |
|---------|-------------------|
| Type    | 1 gang            |
| zamak   | <b>MGU7.002</b>   |
| plastic | <b>MGU7.002.P</b> |

For attachable universal box

#### Fixing frame with short fixed claws



|         |                     |
|---------|---------------------|
| Type    | 1 gang              |
| zamak   | <b>MGU7.002.GG</b>  |
| plastic | <b>MGU7.002.PGL</b> |

For attachable universal box

#### Fixing frame with long fixed claws



|         |                         |
|---------|-------------------------|
| Type    | 1 gang                  |
| zamak   | <b>MGU7.002.GLS</b> (1) |
| plastic | <b>MGU7.002.PGL</b>     |

(1) Mounted with stainless claws

#### Fixing frame without claws



|         |                   |
|---------|-------------------|
| Type    | 2 gang            |
| plastic | <b>MGU7.004.P</b> |

For attachable universal box

#### Short claws with plastic protection



|         |                 |
|---------|-----------------|
| plastic | <b>MGU7.892</b> |
|---------|-----------------|

Set of 20 units

### Italian fixing frames

#### Italian fixing frames



|         |                   |                   |
|---------|-------------------|-------------------|
| Type    | 3 modules         | 4 modules         |
| zamak   | <b>MGU7.103</b>   | <b>MGU7.104</b>   |
| plastic | <b>MGU7.103.P</b> | <b>MGU7.104.P</b> |

### 57 mm interaxis fixing frames

#### Fixing frames without claws



|       |                 |
|-------|-----------------|
| Type  | 1 gang          |
| zamak | <b>MGU7.012</b> |

#### Fixing frames with long stainless claws



|       |                     |
|-------|---------------------|
| Type  | 1 gang              |
| zamak | <b>MGU7.012.GLS</b> |

#### Extension for long claws



|         |                   |
|---------|-------------------|
| plastic | <b>MGU7.892.A</b> |
|---------|-------------------|

Set of 20 units, to be assembled with long claws

### Boxes

#### Surface mounting with clip-on fixing frame



|                |                    |                    |                    |
|----------------|--------------------|--------------------|--------------------|
| Colour         | 1 gang             | 2 gang             | 3 gang             |
| technical grey | <b>MGU8.022.58</b> | <b>MGU8.024.58</b> | <b>MGU8.026.58</b> |
| graphite grey  | <b>MGU8.022.62</b> | <b>MGU8.024.62</b> | <b>MGU8.026.62</b> |

#### Flush mounting

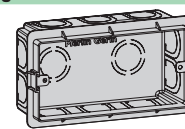
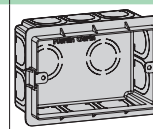
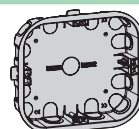
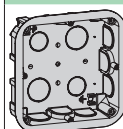

|                 |                 |                 |                 |
|-----------------|-----------------|-----------------|-----------------|
| 2 x 4 modules   | 2 x 6 modules   | 3 modules       | 4 modules       |
| <b>MGU8.624</b> | <b>MGU8.626</b> | <b>MGU8.603</b> | <b>MGU8.604</b> |

#### Insulated box for thin panels



MGU8.601

# Unica Class



# Unica Class aesthetics

## Unica Class Slate



P113198

Natural Slate\*  
MGU68.002.7Z1

## Unica Class Metal



P113192

Ice Aluminium  
MGU68.002.7A1



P113194

Apple Aluminium  
MGU68.002.7A2



P113196

Corten Steel Oxide\*  
MGU68.002.7A3

## Unica Class Glass



P113188

White Glass  
MGU68.002.7C2



P113190

Grey Glass  
MGU68.002.7C3



P113186

Black Mirror  
MGU68.002.7C1

## Unica Class Leather



P113200

Sahara Leather\*  
MGU68.002.7P1



P113202

Truffle Leather\*  
MGU68.002.7P2

*\* Unica Class cover frames are made of true natural materials. For Slate, Oxide, and Leather finishes, the typical natural aesthetic variations of each material have been respected. They are present, making each cover frame unique and different from any other.*





# Slate

Minerals are timeless and eternal. Those qualities bring a very special ambience into a room. Stone enhances the simplicity in all strict and neat surroundings. The individual patterns and shapes of minerals also increase a room's personally flavored distinction.

P116402



P116738

Now you can let this fine-grained and metamorphic rock adorn your home with its natural rough elegance and ancient beauty. The slate version of Unica Class deserves to be admired, but it handles actual touching as well, since it has been anti-fingerprint-treated.

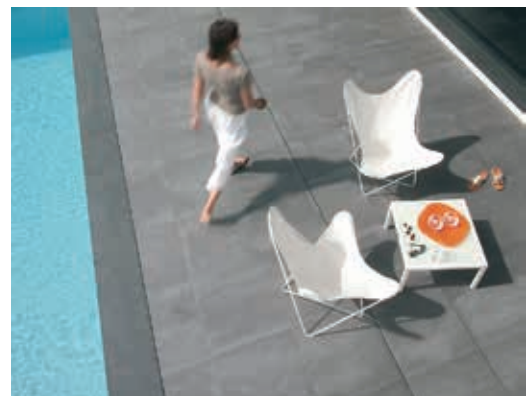

P116737



# Metal

It's shining, it's clean. The Unica Class steel and aluminium covers have a solid elegance which enhances spartan interior ideas.



It's as proper in a working environment, as in the architect's own home. Choose between the brushed Ice or Apple Aluminium, and the Corten Steel with oxidized finishing to get that rusty look.



# Glass

Glass has been used in electric devices from electricity's earliest years. It was also the first modernist architects' preferred material. And now the Unica Class cover frames take the utilization and design of glass one step further.



P116397



P113239

Highlight the crispy ambience in a bright room with Unica Class in radiant white glass, make it exuberant and exciting with black mirror glass, or choose the grey version for a neutral look. All are made of tempered glass for maximum mechanical resistance.



P116391

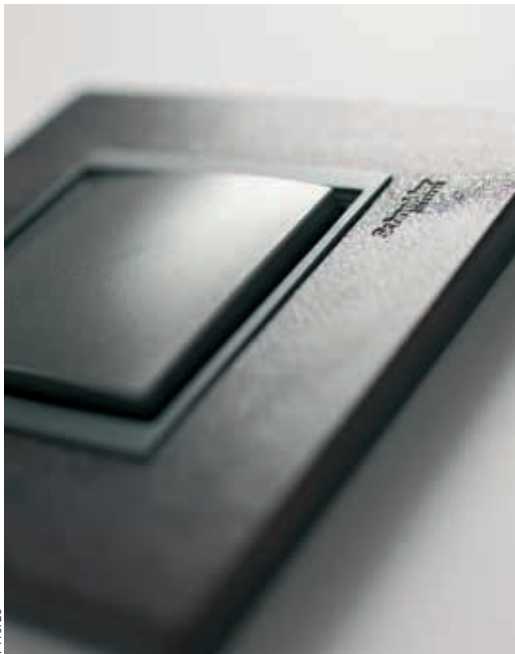

P116723

# Leather

No other material wears the years as well as leather. It's organic, which gives it a completely unique feeling and fragrance. It also has an intriguing shine, which time will increase. And the use of leather in cover frames is as unusual as thrilling!



P116734

The Unica Class frame covers are made of the best quality leather which heightens the level of sophistication in any distinguished setting. Choose between the vibrant chocolate colored Truffle and the creamy beige Sahara.



P116732

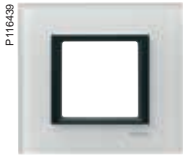

P116439  
MGU68.002.7C2



P116440  
MGU68.004.7C2

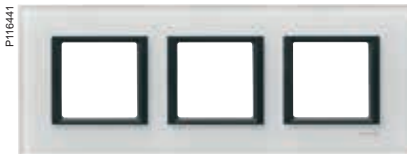

P116441  
MGU68.006.7C2



P116442  
MGU68.008.7C2

## 1 gang



| Colour              |               |
|---------------------|---------------|
| black mirror        | MGU68.002.7C1 |
| white glass         | MGU68.002.7C2 |
| grey glass          | MGU68.002.7C3 |
| ice aluminium       | MGU68.002.7A1 |
| apple aluminium     | MGU68.002.7A2 |
| corten steel oxyde* | MGU68.002.7A3 |
| slate*              | MGU68.002.7Z1 |
| sahara leather*     | MGU68.002.7P1 |
| truffle leather*    | MGU68.002.7P2 |

## 2 gang horizontal and vertical installation

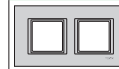

| Colour              |               |
|---------------------|---------------|
| black mirror        | MGU68.004.7C1 |
| white glass         | MGU68.004.7C2 |
| grey glass          | MGU68.004.7C3 |
| ice aluminium       | MGU68.004.7A1 |
| apple aluminium     | MGU68.004.7A2 |
| corten steel oxyde* | MGU68.004.7A3 |
| slate*              | MGU68.004.7Z1 |
| sahara leather*     | MGU68.004.7P1 |
| truffle leather*    | MGU68.004.7P2 |

## 3 gang horizontal and vertical installation



| Colour              |               |
|---------------------|---------------|
| black mirror        | MGU68.006.7C1 |
| white glass         | MGU68.006.7C2 |
| grey glass          | MGU68.006.7C3 |
| ice aluminium       | MGU68.006.7A1 |
| apple aluminium     | MGU68.006.7A2 |
| corten steel oxyde* | MGU68.006.7A3 |
| slate*              | MGU68.006.7Z1 |
| sahara leather*     | MGU68.006.7P1 |
| truffle leather*    | MGU68.006.7P2 |

## 4 gang horizontal and vertical installation



| Colour              |               |
|---------------------|---------------|
| black mirror        | MGU68.008.7C1 |
| white glass         | MGU68.008.7C2 |
| grey glass          | MGU68.008.7C3 |
| ice aluminium       | MGU68.008.7A1 |
| apple aluminium     | MGU68.008.7A2 |
| corten steel oxyde* | MGU68.008.7A3 |
| slate*              | MGU68.008.7Z1 |
| sahara leather*     | MGU68.008.7P1 |
| truffle leather*    | MGU68.008.7P2 |

\* Unica Class cover frames are made of true natural materials. For Slate, Oxide, and Leather finishings, the typical natural aesthetic variations of each material have been respected. They are present, making each cover frame unique and different from any other.



# Unica Top





# Unica Top aesthetics

## With aluminium insert

### Wood

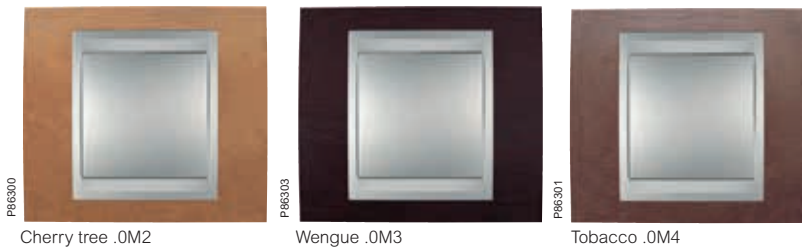

P86300

Cherry tree .0M2

P86303

Wengue .0M3

P86301

Tobacco .0M4

### Metal



P86307

Bright chrome .010

P86304

Glossy chrome .038

P86306

Matt nickel .039

P86305

Metal grey .097

### Colour

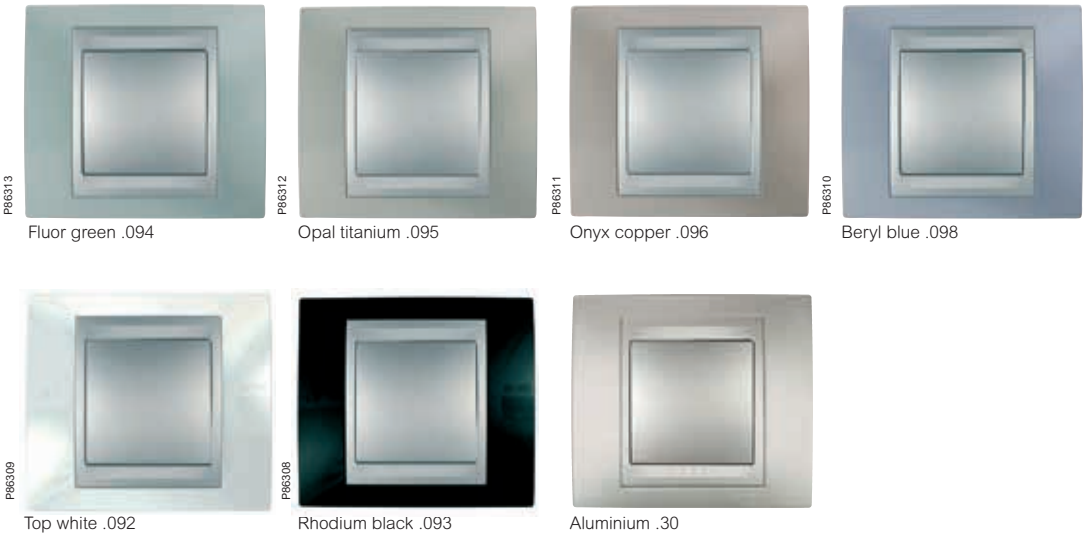

P86313

Fluor green .094

P86312

Opal titanium .095

P86311

Onyx copper .096

P86310

Beryl blue .098

P86309

Top white .092

P86308

Rhodium black .093

Aluminium .30



**With graphite insert**

**Wood**

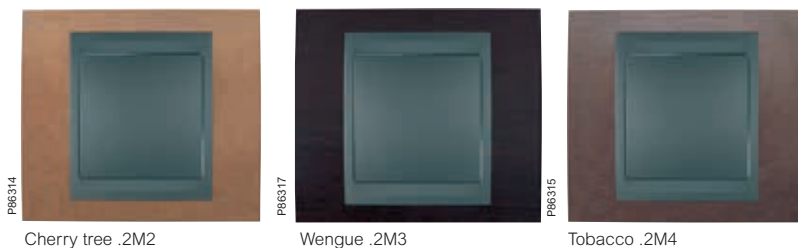

**Metal**

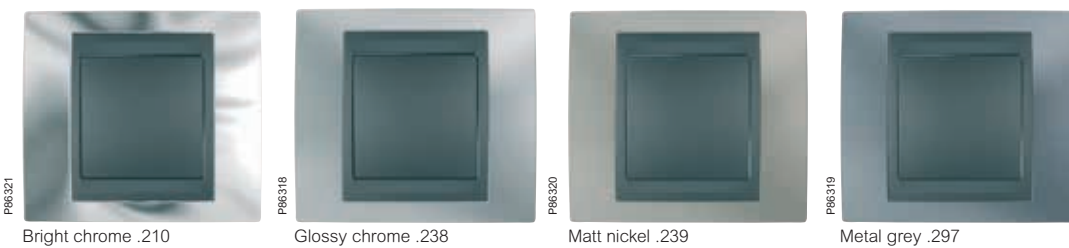

**Colour**

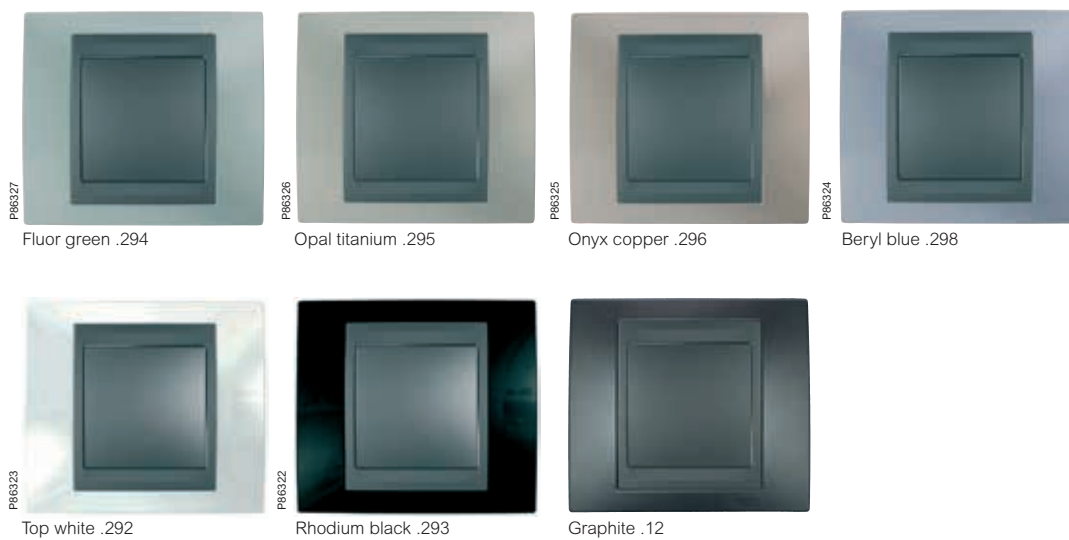

# Unica Top Cover frames



MGU66.002.0M2



MGU66.002.038



MGU66.004.0M2



MGU66.004.038



MGU66.004V.0M2



MGU66.004V.038

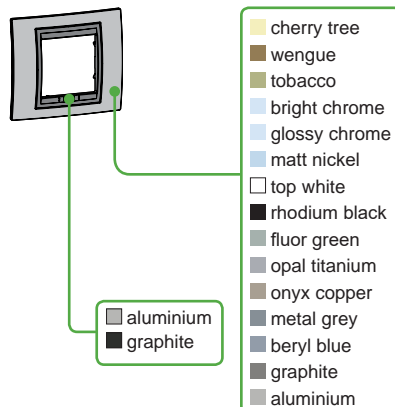

## 1 gang



| Colour        | Aluminium     | Graphite      |
|---------------|---------------|---------------|
| cherry tree   | MGU66.002.0M2 | MGU66.002.2M2 |
| wengue        | MGU66.002.0M3 | MGU66.002.2M3 |
| tobacco       | MGU66.002.0M4 | MGU66.002.2M4 |
| bright chrome | MGU66.002.010 | MGU66.002.210 |
| glossy chrome | MGU66.002.038 | MGU66.002.238 |
| matt nickel   | MGU66.002.039 | MGU66.002.239 |
| top white     | MGU66.002.092 | MGU66.002.292 |
| rhodium black | MGU66.002.093 | MGU66.002.293 |
| fluor green   | MGU66.002.094 | MGU66.002.294 |
| opal titanium | MGU66.002.095 | MGU66.002.295 |
| onyx copper   | MGU66.002.096 | MGU66.002.296 |
| metal grey    | MGU66.002.097 | MGU66.002.297 |
| beryl blue    | MGU66.002.098 | MGU66.002.298 |
| graphite      |               | MGU6.002.12   |
| aluminium     | MGU6.002.30   |               |

## 2 gang horizontal installation

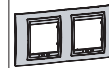

| Colour        | Aluminium     | Graphite      |
|---------------|---------------|---------------|
| cherry tree   | MGU66.004.0M2 | MGU66.004.2M2 |
| wengue        | MGU66.004.0M3 | MGU66.004.2M3 |
| tobacco       | MGU66.004.0M4 | MGU66.004.2M4 |
| bright chrome | MGU66.004.010 | MGU66.004.210 |
| glossy chrome | MGU66.004.038 | MGU66.004.238 |
| matt nickel   | MGU66.004.039 | MGU66.004.239 |
| top white     | MGU66.004.092 | MGU66.004.292 |
| rhodium black | MGU66.004.093 | MGU66.004.293 |
| fluor green   | MGU66.004.094 | MGU66.004.294 |
| opal titanium | MGU66.004.095 | MGU66.004.295 |
| onyx copper   | MGU66.004.096 | MGU66.004.296 |
| metal grey    | MGU66.004.097 | MGU66.004.297 |
| beryl blue    | MGU66.004.098 | MGU66.004.298 |
| graphite      |               | MGU6.004.12   |
| aluminium     | MGU6.004.30   |               |

## 2 gang vertical installation



| Colour        | Aluminium      | Graphite       |
|---------------|----------------|----------------|
| cherry tree   | MGU66.004V.0M2 | MGU66.004V.2M2 |
| wengue        | MGU66.004V.0M3 | MGU66.004V.2M3 |
| tobacco       | MGU66.004V.0M4 | MGU66.004V.2M4 |
| bright chrome | MGU66.004V.010 | MGU66.004V.210 |
| glossy chrome | MGU66.004V.038 | MGU66.004V.238 |
| matt nickel   | MGU66.004V.039 | MGU66.004V.239 |
| top white     | MGU66.004V.092 | MGU66.004V.292 |
| rhodium black | MGU66.004V.093 | MGU66.004V.293 |
| fluor green   | MGU66.004V.094 | MGU66.004V.294 |
| opal titanium | MGU66.004V.095 | MGU66.004V.295 |
| onyx copper   | MGU66.004V.096 | MGU66.004V.296 |
| metal grey    | MGU66.004V.097 | MGU66.004V.297 |
| beryl blue    | MGU66.004V.098 | MGU66.004V.298 |
| graphite      |                | MGU6.004V.12   |
| aluminium     | MGU6.004V.30   |                |

# Unica Top Cover frames



P108421  
MGU66.006.0M2



P108443  
MGU66.006.038



P108453  
MGU66.006V.0M2



P108411  
MGU66.006V.038



P108455  
MGU66.008.0M2



P108475  
MGU66.008.038

## 3 gang horizontal installation

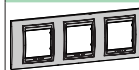

| Colour        | Aluminium     | Graphite      |
|---------------|---------------|---------------|
| cherry tree   | MGU66.006.0M2 | MGU66.006.2M2 |
| wengue        | MGU66.006.0M3 | MGU66.006.2M3 |
| tobacco       | MGU66.006.0M4 | MGU66.006.2M4 |
| bright chrome | MGU66.006.010 | MGU66.006.210 |
| glossy chrome | MGU66.006.038 | MGU66.006.238 |
| matt nickel   | MGU66.006.039 | MGU66.006.239 |
| top white     | MGU66.006.092 | MGU66.006.292 |
| rhodium black | MGU66.006.093 | MGU66.006.293 |
| fluor green   | MGU66.006.094 | MGU66.006.294 |
| opal titanium | MGU66.006.095 | MGU66.006.295 |
| onyx copper   | MGU66.006.096 | MGU66.006.296 |
| metal grey    | MGU66.006.097 | MGU66.006.297 |
| beryl blue    | MGU66.006.098 | MGU66.006.298 |
| graphite      |               | MGU6.006.12   |
| aluminium     | MGU6.006.30   |               |

## 3 gang vertical installation



| Colour        | Aluminium      | Graphite       |
|---------------|----------------|----------------|
| cherry tree   | MGU66.006V.0M2 | MGU66.006V.2M2 |
| wengue        | MGU66.006V.0M3 | MGU66.006V.2M3 |
| tobacco       | MGU66.006V.0M4 | MGU66.006V.2M4 |
| bright chrome | MGU66.006V.010 | MGU66.006V.210 |
| glossy chrome | MGU66.006V.038 | MGU66.006V.238 |
| matt nickel   | MGU66.006V.039 | MGU66.006V.239 |
| top white     | MGU66.006V.092 | MGU66.006V.292 |
| rhodium black | MGU66.006V.093 | MGU66.006V.293 |
| fluor green   | MGU66.006V.094 | MGU66.006V.294 |
| opal titanium | MGU66.006V.095 | MGU66.006V.295 |
| onyx copper   | MGU66.006V.096 | MGU66.006V.296 |
| metal grey    | MGU66.006V.097 | MGU66.006V.297 |
| beryl blue    | MGU66.006V.098 | MGU66.006V.298 |
| graphite      |                | MGU6.006V.12   |
| aluminium     | MGU6.006V.30   |                |

## 4 gang horizontal installation



| Colour        | Aluminium     | Graphite      |
|---------------|---------------|---------------|
| cherry tree   | MGU66.008.0M2 | MGU66.008.2M2 |
| wengue        | MGU66.008.0M3 | MGU66.008.2M3 |
| tobacco       | MGU66.008.0M4 | MGU66.008.2M4 |
| bright chrome | MGU66.008.010 | MGU66.008.210 |
| glossy chrome | MGU66.008.038 | MGU66.008.238 |
| matt nickel   | MGU66.008.039 | MGU66.008.239 |
| top white     | MGU66.008.092 | MGU66.008.292 |
| rhodium black | MGU66.008.093 | MGU66.008.293 |
| fluor green   | MGU66.008.094 | MGU66.008.294 |
| opal titanium | MGU66.008.095 | MGU66.008.295 |
| onyx copper   | MGU66.008.096 | MGU66.008.296 |
| metal grey    | MGU66.008.097 | MGU66.008.297 |
| beryl blue    | MGU66.008.098 | MGU66.008.298 |
| graphite      |               | MGU6.008.12   |
| aluminium     | MGU6.008.30   |               |



P109748

MGU66.014V.0M2



P109742

MGU66.014V.038



P109768

MGU66.016V.0M2



P109762

MGU66.016V.038

## 2 gang 57 mm interaxis vertical installation



| Colour        | Aluminium      | Graphite       |
|---------------|----------------|----------------|
| cherry tree   | MGU66.014V.0M2 | MGU66.014V.2M2 |
| wengue        | MGU66.014V.0M3 | MGU66.014V.2M3 |
| tobacco       | MGU66.014V.0M4 | MGU66.014V.2M4 |
| bright chrome | MGU66.014V.010 | MGU66.014V.210 |
| glossy chrome | MGU66.014V.038 | MGU66.014V.238 |
| matt nickel   | MGU66.014V.039 | MGU66.014V.239 |
| top white     | MGU66.014V.092 | MGU66.014V.292 |
| onyx copper   | MGU66.014V.096 | MGU66.014V.296 |
| metal grey    | MGU66.014V.097 | MGU66.014V.297 |

## 3 gang 57 mm interaxis vertical installation

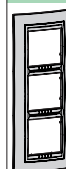

| Colour        | Aluminium      | Graphite       |
|---------------|----------------|----------------|
| cherry tree   | MGU66.016V.0M2 |                |
| wengue        |                | MGU66.016V.2M3 |
| tobacco       |                | MGU66.016V.2M4 |
| bright chrome | MGU66.016V.010 | MGU66.016V.210 |
| glossy chrome | MGU66.016V.038 | MGU66.016V.238 |
| matt nickel   | MGU66.016V.039 | MGU66.016V.239 |
| top white     | MGU66.016V.092 | MGU66.016V.292 |
| onyx copper   | MGU66.016V.096 | MGU66.016V.296 |
| metal grey    | MGU66.016V.097 | MGU66.016V.297 |

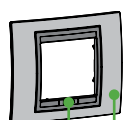

- cherry tree
- wengue
- tobacco
- bright chrome
- glossy chrome
- matt nickel
- top white
- onyx copper
- metal grey

- aluminium
- graphite

P84192



MGU66.103.0M3

P84428



MGU66.103.0M4

P84495



MGU66.104.092

P84551



MGU66.104.292

P130295



MGU66.106.092

P130308



MGU66.106.292

### 3 modules Italian cover frame



| Colour        | Aluminium     | Graphite      |
|---------------|---------------|---------------|
| cherry tree   | MGU66.103.0M2 | MGU66.103.2M2 |
| wengue        | MGU66.103.0M3 | MGU66.103.2M3 |
| tobacco       | MGU66.103.0M4 | MGU66.103.2M4 |
| bright chrome | MGU66.103.010 | MGU66.103.210 |
| glossy chrome | MGU66.103.038 | MGU66.103.238 |
| matt nickel   | MGU66.103.039 | MGU66.103.239 |
| top white     | MGU66.103.092 | MGU66.103.292 |
| rhodium black | MGU66.103.093 | MGU66.103.293 |
| fluor green   | MGU66.103.094 | MGU66.103.294 |
| opal titanium | MGU66.103.095 | MGU66.103.295 |
| onyx copper   | MGU66.103.096 | MGU66.103.296 |
| metal grey    | MGU66.103.097 | MGU66.103.297 |
| beryl blue    | MGU66.103.098 | MGU66.103.298 |
| graphite      |               | MGU6.103.12   |
| aluminium     | MGU6.103.30   |               |
| gold          |               | MGU66.103.204 |

### 4 modules Italian cover frame



| Colour        | Aluminium     | Graphite      |
|---------------|---------------|---------------|
| cherry tree   | MGU66.104.0M2 | MGU66.104.2M2 |
| wengue        | MGU66.104.0M3 | MGU66.104.2M3 |
| tobacco       | MGU66.104.0M4 | MGU66.104.2M4 |
| bright chrome | MGU66.104.010 | MGU66.104.210 |
| glossy chrome | MGU66.104.038 | MGU66.104.238 |
| matt nickel   | MGU66.104.039 | MGU66.104.239 |
| top white     | MGU66.104.092 | MGU66.104.292 |
| rhodium black | MGU66.104.093 | MGU66.104.293 |
| fluor green   |               | MGU66.104.294 |
| opal titanium | MGU66.104.095 | MGU66.104.295 |
| onyx copper   | MGU66.104.096 | MGU66.104.296 |
| metal grey    | MGU66.104.097 | MGU66.104.297 |
| beryl blue    | MGU66.104.098 | MGU66.104.298 |
| graphite      |               | MGU6.104.12   |
| aluminium     | MGU6.104.30   |               |

### 6 modules Italian cover frame



| Colour        | Aluminium     | Graphite      |
|---------------|---------------|---------------|
| cherry tree   | MGU66.106.0M2 | MGU66.106.2M2 |
| wengue        | MGU66.106.0M3 | MGU66.106.2M3 |
| tobacco       | MGU66.106.0M4 | MGU66.106.2M4 |
| bright chrome | MGU66.106.010 | MGU66.106.210 |
| glossy chrome | MGU66.106.038 | MGU66.106.238 |
| matt nickel   | MGU66.106.039 | MGU66.106.239 |
| top white     | MGU66.106.092 | MGU66.106.292 |
| rhodium black | MGU66.106.093 | MGU66.106.293 |
| fluor green   | MGU66.106.094 | MGU66.106.294 |
| opal titanium | MGU66.106.095 | MGU66.106.295 |
| onyx copper   | MGU66.106.096 | MGU66.106.296 |
| metal grey    | MGU66.106.097 | MGU66.106.297 |
| beryl blue    | MGU66.106.098 | MGU66.106.298 |
| graphite      |               | MGU6.106.12   |
| aluminium     | MGU6.106.30   |               |



MGU49.424.010



MGU49.426.238

## Centralization cover frames

### 2 X 4 modules



| Colour        | Aluminium            | Graphite             |
|---------------|----------------------|----------------------|
| bright chrome | <b>MGU49.424.010</b> | <b>MGU49.424.210</b> |
| glossy chrome | <b>MGU49.424.038</b> | <b>MGU49.424.238</b> |
| matt nickel   | <b>MGU49.424.039</b> | <b>MGU49.424.239</b> |

Delivered with 2 x 4 modules plastic fixing frame

### 2 X 6 modules



| Colour        | Aluminium            | Graphite             |
|---------------|----------------------|----------------------|
| bright chrome | <b>MGU49.426.010</b> | <b>MGU49.426.210</b> |
| glossy chrome | <b>MGU49.426.038</b> | <b>MGU49.426.238</b> |
| matt nickel   | <b>MGU49.426.039</b> | <b>MGU49.426.239</b> |

Delivered with 2 x 6 modules plastic fixing frame





MGU47.201.30P

## Cover and fixing frames for thin panels

### Cover and fixing frames for thin panels



| Colour      | 1 module             | 1 + 1 module         |
|-------------|----------------------|----------------------|
| ■ aluminium | <b>MGU47.201.30P</b> | <b>MGU47.202.30P</b> |
| ■ graphite  | <b>MGU47.201.12P</b> | <b>MGU47.202.12P</b> |

Unica Plus  
Unica Quadro  
Unica Allegro  
Unica Colors  
Unica Basic

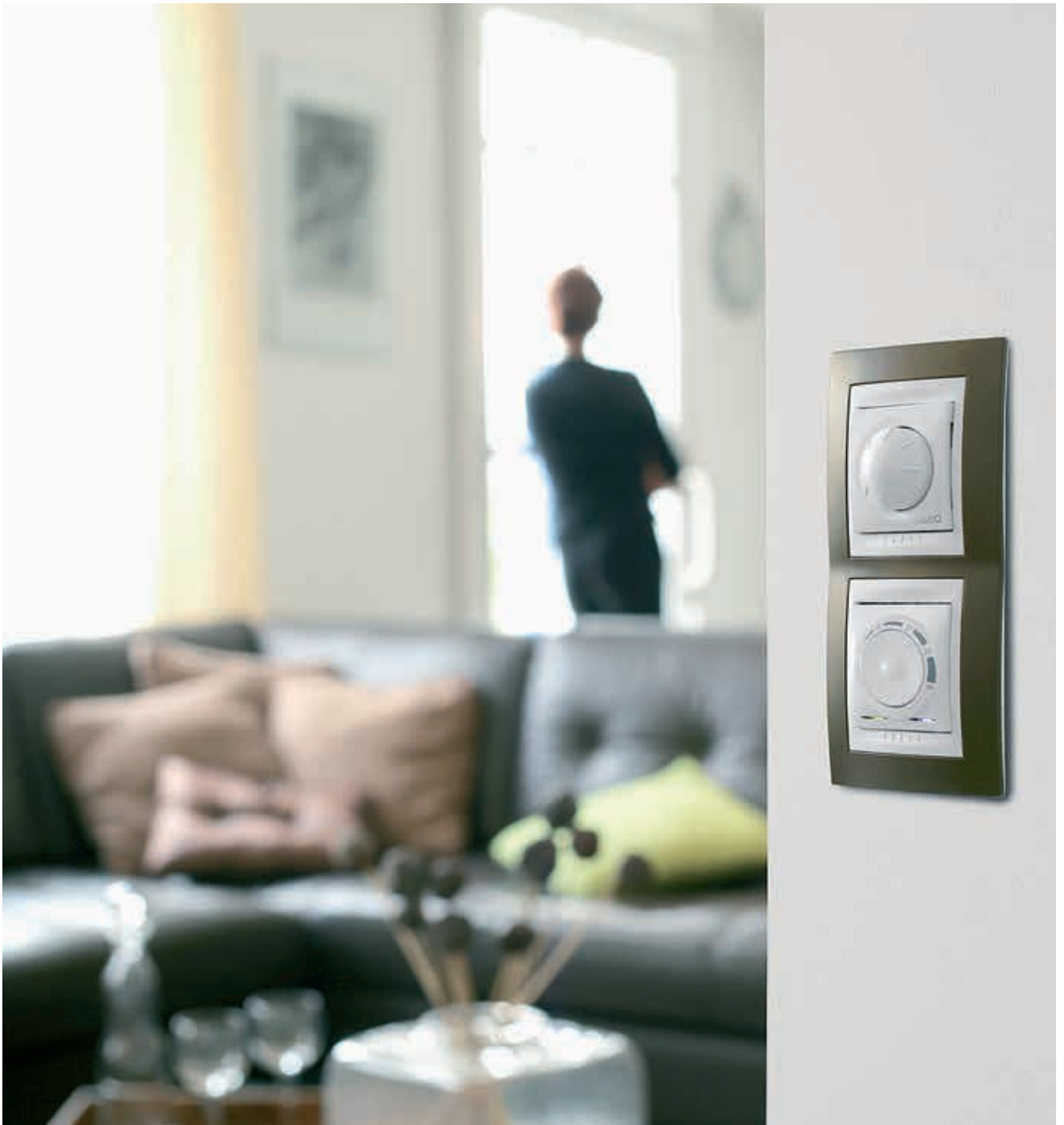

P80184



Unica Plus

P84832



Unica Quadro

P104530



Unica Allegro

P86338



Unica Colors

P81489



Unica Basic

P86055



P104898

# Sheer design joy

The essentials in our life are the small things; the little extras in the everyday that make a difference. The Unica range offers just that the essential little extra, a choice clearly above the design of the mainstream selection. Including endless stylish, fresh and innovative solutions. From the more refined, exclusive Unica Plus with temptingly comfortable functionality choices, to the sober and timeless style manifested in Unica Basic. Release your inner aesthetic desire. Rejoice at the available choices; from the sparkingly colourful with accented shapes, young, fresh and modern, to the sober, timeless and luxuriously stylish. Let your home reflect your personality. Personal style prevails!



P105753

### Weekly programmable thermostat

To have the home at the right temperature every time optimizing the energy.



P105754

### Rotary dimmer

Create lighting ambiances, save energy and money.

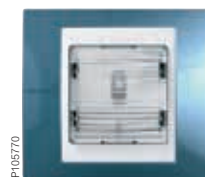

P105770

### Emergency light

Ever been in a bathroom without windows during a power failure? Don't be!



P1105756

**Movement and presence detector**  
Automatically activates light (or others functions) when you enter.



P1105758

**Time delay switch**  
For areas where you pass through. Truly energy-saving will make sure the light is only on for a short time, no need to think about switching off. Can easily be combined with a movement detector.



P1105757

**Wireless comfort**  
Do you want different lighting scenarios? Or a centralized roller-blind control? No problem! With Unica remote control and movable push-buttons you are in charge from your sofa.



P1105759

**RCD switch**  
Add more security and protect the electrical system.



P1104678



P1105760

**Roller-blind (and/or curtain) switch**  
Lights out or not? Easy peace!



P129465

**Technical alarms**  
Protect your home against flooding and gas leaks.

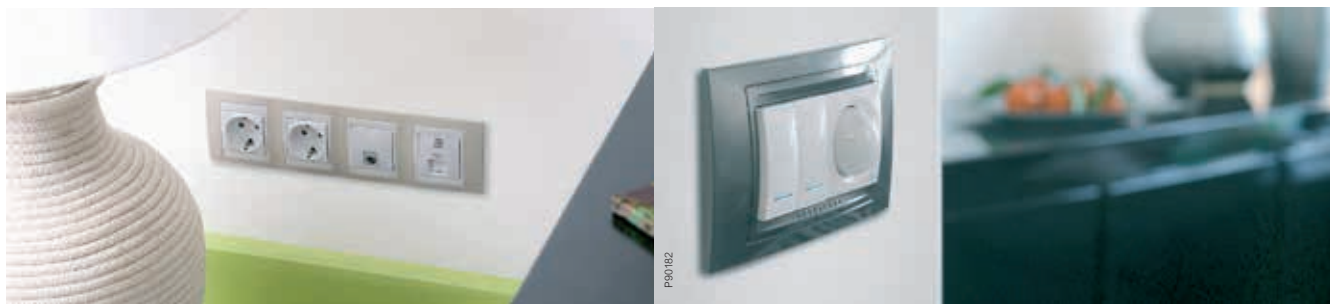

P90185

P90182



## Controls

### 10 AX – 250 V AC switches



| 10 AX one-way screwless terminals |                    | 10 AX one-way screw terminals |                     |
|-----------------------------------|--------------------|-------------------------------|---------------------|
|                                   | 1 — L              |                               | 4 — 2               |
| Colour                            | ■ 2 modules        | ■ 1 module                    | ■ 2 modules         |
| □ white                           | <b>MGU3.101.18</b> | <b>MGU3.101.18</b>            | <b>MGU3.201T.18</b> |
| ■ ivory                           | <b>MGU3.201.25</b> | <b>MGU3.101.25</b>            | <b>MGU3.101T.18</b> |
|                                   |                    |                               | <b>MGU3.201T.25</b> |



| 10 AX two-way screwless terminals |                    | 10 AX two-way screw terminals |                     |
|-----------------------------------|--------------------|-------------------------------|---------------------|
|                                   | 1 — L<br>2 — L     |                               | 4 — 2<br>1 — 2      |
| Colour                            | ■ 2 modules        | ■ 1 module                    | ■ 2 modules         |
| □ white                           | <b>MGU3.203.18</b> | <b>MGU3.103.18</b>            | <b>MGU3.203T.18</b> |
| ■ ivory                           | <b>MGU3.203.25</b> | <b>MGU3.103.25</b>            | <b>MGU3.103T.25</b> |



| 10 AX intermediate screwless terminals |                    | 10 AX intermediate screw terminals |                     |
|--|--------------------|------------------------------------|---------------------|
|  | 4 — 2<br>3 — 1     |                                    | 4 — 2<br>3 — 1      |
| Colour                                 | ■ 2 modules        | ■ 1 module                         | ■ 1 module          |
| □ white                                | <b>MGU3.205.18</b> | <b>MGU3.105.18</b>                 | <b>MGU3.105T.18</b> |
| ■ ivory                                | <b>MGU3.205.25</b> | <b>MGU3.105.25</b>                 |                     |



| 10 AX double one-way screwless terminals |                    |
|--|--------------------|
|  | 1 — L<br>1 — L     |
| Colour                                   | ■ 2 modules        |
| □ white                                  | <b>MGU3.211.18</b> |
| ■ ivory                                  | <b>MGU3.211.25</b> |

With internal power connection

| 10 AX double two-way screwless terminals |                                  |
|--|----------------------------------|
|  | 1 — L<br>2 — L<br>1 — L<br>2 — L |
| Colour                                   | ■ 2 modules                      |
| □ white                                  | <b>MGU3.213.18</b>               |
| ■ ivory                                  | <b>MGU3.213.25</b>               |

With external power connection



| 16 AX one-way screw terminals |                    | 16 AX double pole one-way screw terminals |                    |
|-------------------------------|--------------------|---|--------------------|
|                               | 1 — L              |   | 1 — L1<br>2 — L2   |
| Colour                        | ■ 2 modules        | ■ 1 module                                | ■ 2 modules        |
| □ white                       | <b>MGU3.261.18</b> | <b>MGU3.161.18</b>                        | <b>MGU3.262.18</b> |
| ■ ivory                       | <b>MGU3.261.25</b> | <b>MGU3.161.25</b>                        | <b>MGU3.162.18</b> |
|                               |                    |   | <b>MGU3.262.25</b> |
|                               |                    |   | <b>MGU3.162.25</b> |



| 16 AX two-way screw terminals |                    |
|-------------------------------|--------------------|
|                               | 1 — L<br>2 — L     |
| Colour                        | ■ 2 modules        |
| □ white                       | <b>MGU3.263.18</b> |
| ■ ivory                       | <b>MGU3.263.25</b> |
|                               | <b>MGU3.163.18</b> |
|                               | <b>MGU3.163.25</b> |



MGU3.201.18N



MGU3.101.18N

## 10 AX – 250 V AC switches with blue locator lamp

### 10 AX one-way screwless terminals



|        |              |              |               |               |
|--------|--------------|--------------|---------------|---------------|
| Colour | 2 modules    | 1 module     | 2 modules     | 1 module      |
| white  | MGU3.201.18N | MGU3.101.18N | MGU3.201T.18N | MGU3.101T.18N |
| ivory  | MGU3.201.25N | MGU3.101.25N |               |               |

Blue LED lamp, connected internally

### 10 AX two-way screwless terminals



|        |              |              |               |
|--------|--------------|--------------|---------------|
| Colour | 2 modules    | 1 module     | 1 module      |
| white  | MGU3.203.18N | MGU3.103.18N | MGU3.103T.18N |
| ivory  | MGU3.203.25N | MGU3.103.25N |               |

Blue LED lamp, connected internally

### 10 AX intermediate screwless terminals



|        |              |              |               |
|--------|--------------|--------------|---------------|
| Colour | 2 modules    | 1 module     | 1 module      |
| white  | MGU3.205.18N | MGU3.105.18N | MGU3.105T.18N |
| ivory  | MGU3.205.25N | MGU3.105.25N |               |

Blue LED lamp, connected internally

### 10 AX one-way screw terminals



### 10 AX two-way screw terminals

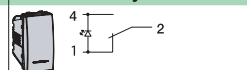

### 10 AX intermediate screw terminals

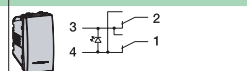

## 10 AX – 250 V AC switches with amber indicator lamp

### 10 AX one-way screwless terminals



|        |              |              |              |              |
|--------|--------------|--------------|--------------|--------------|
| Colour | 2 modules    | 1 module     | 2 modules    | 1 module     |
| white  | MGU3.201.18S | MGU3.101.18S | MGU3.203.18S | MGU3.103.18S |
| ivory  | MGU3.201.25S | MGU3.101.25S | MGU3.203.25S | MGU3.103.25S |

Amber LED lamp, connected internally

### 10 AX two-way screwless terminals



MGU3.201.18S



MGU3.101.18S

## 16 AX – 250 V AC switches with blue locator lamp

### 16 AX one-way screw terminals



|        |              |              |              |              |
|--------|--------------|--------------|--------------|--------------|
| Colour | 2 modules    | 1 module     | 2 modules    | 1 module     |
| white  | MGU3.261.18N | MGU3.161.18N | MGU3.263.18N | MGU3.163.18N |
| ivory  | MGU3.261.25N | MGU3.161.25N | MGU3.263.25N | MGU3.163.25N |

Blue LED lamp, connected internally

### 16 AX two-way screw terminals

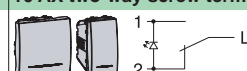

MGU3.261.18N



MGU3.161.18N

## 16 AX – 250 V AC switches with amber indicator lamp

### 16 AX one-way screw terminals



|        |              |              |              |              |
|--------|--------------|--------------|--------------|--------------|
| Colour | 2 modules    | 1 module     | 2 modules    | 1 module     |
| white  | MGU3.261.18S | MGU3.161.18S | MGU3.262.18S | MGU3.162.18S |
| ivory  | MGU3.261.25S | MGU3.161.25S | MGU3.262.25S | MGU3.162.25S |

Amber LED lamp, connected internally

### 16 AX double pole one-way screw terminals



|        |              |              |              |              |
|--------|--------------|--------------|--------------|--------------|
| Colour | 2 modules    | 1 module     | 2 modules    | 1 module     |
| white  | MGU3.261.18S | MGU3.161.18S | MGU3.262.18S | MGU3.162.18S |
| ivory  | MGU3.261.25S | MGU3.161.25S | MGU3.262.25S | MGU3.162.25S |

Amber LED lamp, connected internally

### 16 AX two-way screw terminals



|        |              |              |  |  |
|--------|--------------|--------------|--|--|
| Colour | 2 modules    | 1 module     |  |  |
| white  | MGU3.263.18S | MGU3.163.18S |  |  |
| ivory  | MGU3.263.25S | MGU3.163.25S |  |  |

Amber LED lamp, connected internally



MGU3.261.18S



MGU3.161.18S



MGU3.263.18S

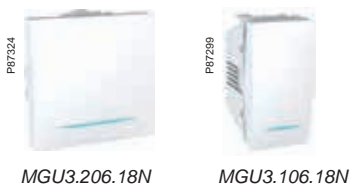

## 10 A – 250 V AC push-buttons

### 10 A screwless terminals



| Colour | 2 modules   | 1 module    |
|--------|-------------|-------------|
| white  | MGU3.206.18 | MGU3.106.18 |
| ivory  | MGU3.206.25 | MGU3.106.25 |

### 10 A screw terminals

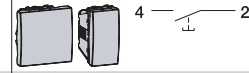

| Colour | 2 modules    | 1 module     |
|--------|--------------|--------------|
| white  | MGU3.206T.18 | MGU3.106T.18 |
| ivory  |              | MGU3.106T.25 |

### 10 A screwless terminals with bell symbol



| Colour | 2 modules    | 1 module     |
|--------|--------------|--------------|
| white  | MGU3.206.18C | MGU3.106.18C |
| ivory  | MGU3.206.25C | MGU3.106.25C |

### 10 A screwless terminals

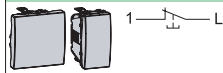

| Colour | 2 modules   | 1 module    |
|--------|-------------|-------------|
| white  | MGU3.236.18 | MGU3.136.18 |
| ivory  | MGU3.236.25 | MGU3.136.25 |

### 10 A screwless terminals with light symbol

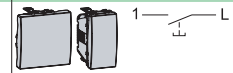

| Colour | 2 modules    | 1 module     |
|--------|--------------|--------------|
| white  | MGU3.206.18L | MGU3.106.18L |
| ivory  | MGU3.206.25L | MGU3.106.25L |

Normally closed position

## 10 A – 250 V AC push-buttons with blue locator lamp

### 10 A screwless terminals

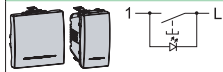

| Colour | 2 modules    | 1 module     |
|--------|--------------|--------------|
| white  | MGU3.206.18N | MGU3.106.18N |
| ivory  | MGU3.206.25N | MGU3.106.25N |

### 10 A screw terminals



| Colour | 2 modules     | 1 module      |
|--------|---------------|---------------|
| white  | MGU3.206T.18N | MGU3.106T.18N |
| ivory  |               | MGU3.106T.25N |

Blue LED lamp, connected internally

### 10 A screwless with light symbol

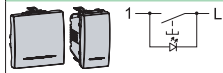

| Colour | 2 modules     | 1 module      |
|--------|---------------|---------------|
| white  | MGU3.206.18LN | MGU3.106.18LN |
| ivory  | MGU3.206.25LN | MGU3.106.25LN |

Blue LED lamp, connected internally

### 10 A screwless with bell symbol

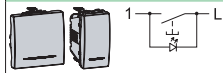

| Colour | 2 modules     | 1 module      |
|--------|---------------|---------------|
| white  | MGU3.206.18CN | MGU3.106.18CN |
| ivory  | MGU3.206.25CN | MGU3.106.25CN |

Blue LED lamp, connected internally





MGU3.216.18CN



MGU3.246.1812v

## 10 A – 12 V AC push-buttons

### 10 A screwless terminals with bell symbol

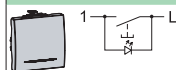

Colour  2 modules

white **MGU3.216.18CN**

ivory **MGU3.216.25CN**

Blue LED lamp, connected internally

### 10 A screw terminals with illuminated label holder

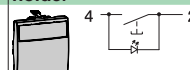

Colour  2 modules

white **MGU3.246.1812V**

ivory **MGU3.246.2512V**

Amber LED lamp, connected internally



MGU3.701.18



MGU3.579.18

## Key and rotary switches

### Key switch - 2 positions



Colour  2 modules

white **MGU3.701.18**

ivory **MGU3.701.25**

### 40- 3000 W/VA rotary switch - 4 positions

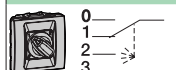

Colour  2 modules

white **MGU3.579.18**

ivory **MGU3.579.25**

## Replacement lamps

### LED for 250 V AC switches and push-buttons with locator/indicator lamp

Colour

amber

**MGU0.825.AL**

blue

**MGU0.825.AZL**

For switches and push-buttons with screwless terminals from November 2011 (except intermediate switches)

**MGU0.822.AL**

**MGU0.822.AZL**

- Before November 2011, for all switches and push-buttons,
- From November 2011, for switches and push-buttons with screw terminals and intermediate switches.



MGU0.825.AL



MGU0.825.AZL



MGU0.822.AL



MGU0.822.AZL



MGU0.823.AM

### LED for 12 V AC push-buttons

Colour

yellow

**MGU0.823.AM**

## Specialized controls

### Mechanisms for roller blinds



MGU3.208.18



MGU3.207.18



MGU3.208T.18



MGU3.207T.18



MGU3.108T.18



MGU3.107T.18



MGU3.109T.18

| 10 A switch screwless          |                    | 10 A push-button screwless     |                    |
|--------------------------------|--------------------|--------------------------------|--------------------|
|                                |                    |                                |                    |
| Colour                         | 2 modules          | Colour                         | 2 modules          |
| <input type="checkbox"/> white | <b>MGU3.208.18</b> | <input type="checkbox"/> white | <b>MGU3.207.18</b> |
| <input type="checkbox"/> ivory | <b>MGU3.208.25</b> | <input type="checkbox"/> ivory | <b>MGU3.207.25</b> |

With mechanical and electrical safety latching to prevent simultaneous activation in both directions

| 10 A switch with screw terminals |                     | 10 A push-button with screw terminals |                     |
|----------------------------------|---------------------|---------------------------------------|---------------------|
|                                  |                     |                                       |                     |
| Colour                           | 2 modules           | Colour                                | 2 modules           |
| <input type="checkbox"/> white   | <b>MGU3.208T.18</b> | <input type="checkbox"/> white        | <b>MGU3.207T.18</b> |

With mechanical and electrical safety latching to prevent simultaneous activation in both directions

| 10 A switch with screw terminals |                     | 10 A push-button with screw terminals |                     |
|----------------------------------|---------------------|---------------------------------------|---------------------|
|                                  |                     |                                       |                     |
| Colour                           | 1 module            | Colour                                | 1 module            |
| <input type="checkbox"/> white   | <b>MGU3.108T.18</b> | <input type="checkbox"/> white        | <b>MGU3.107T.18</b> |
| <input type="checkbox"/> ivory   | <b>MGU3.108T.25</b> | <input type="checkbox"/> ivory        | <b>MGU3.107T.25</b> |

With mechanical and electrical safety latching to prevent simultaneous activation in both directions

| 10 AX double pole switch with screw terminals |                     |
|---|---------------------|
|   |                     |
| Colour  | 1 module            |
| <input type="checkbox"/> white                | <b>MGU3.109T.18</b> |
| <input type="checkbox"/> ivory                | <b>MGU3.109T.25</b> |

With mechanical and electrical safety latching to prevent simultaneous activation in both directions

### Cord push-button

| 250 V with pull                |                    |
|--------------------------------|--------------------|
|                                |                    |
| Colour                         | 2 modules          |
| <input type="checkbox"/> white | <b>MGU3.226.18</b> |
| <input type="checkbox"/> ivory | <b>MGU3.226.25</b> |

Cable length : 1 m

### Mechanisms for VMC

| VMC speed switch screwless     |                       | VMC two speed and ON/OFF switch screwless |                    |
|--------------------------------|-----------------------|---|--------------------|
|                                |                       |   |                    |
| Colour                         | 2 modules             | Colour                                    | 2 modules          |
| <input type="checkbox"/> white | <b>MGU3.203.18VMC</b> | <input type="checkbox"/> white            | <b>MGU3.214.18</b> |

P87327

P87326

P87783

P87785

P150383

P150654

P150983

P87334

P139118

P139119



MGU3.223.18



MGU3.224.18

## 20 A – 250 V high rating switches

### 20 A (16 AX) two-way with screw terminals

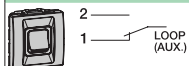

|         |                    |
|---------|--------------------|
| Colour  | 2 modules          |
| □ white | <b>MGU3.223.18</b> |
| ■ ivory |                    |

### 20 AX double pole one-way with screw terminals

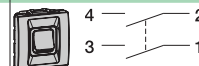

|         |                    |
|---------|--------------------|
| Colour  | 2 modules          |
| □ white | <b>MGU3.224.18</b> |
| ■ ivory | <b>MGU3.224.25</b> |



MGU3.231.18

## 32 A – 250 V high rating switches

### 32 A (25 AX) one-way with screw terminals

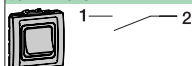

|         |                    |
|---------|--------------------|
| Colour  | 2 modules          |
| □ white | <b>MGU3.231.18</b> |
| ■ ivory | <b>MGU3.231.25</b> |



MGU3.224.18S

## 20 AX – 250 V high rating switch with amber indicator lamp

### 20 AX double pole one-way with screw terminals

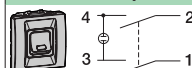

|         |                     |
|---------|---------------------|
| Colour  | 2 modules           |
| □ white | <b>MGU3.224.18S</b> |
| ■ ivory | <b>MGU3.224.25S</b> |

Amber neon lamp, connected internally



MGU3.232.18S

## 32 AX – 250 V high rating switch with amber indicator lamp

### 32 AX double pole one-way with screw terminals

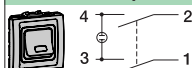

|         |                     |
|---------|---------------------|
| Colour  | 2 modules           |
| □ white | <b>MGU3.232.18S</b> |
| ■ ivory | <b>MGU3.232.25S</b> |

Amber neon lamp, connected internally



MGU3.654.18



MGU3.655.18



MGU3.656.18



MGU3.610.18



MGU3.611.18



MGU3.630.18



MGU3.631.18



MGU3.632.18

## Protection

### Miniature circuit breaker (MCB) switches

| 6 A 1P                         |                    | 10 A 1P            |  |
|--------------------------------|--------------------|--------------------|--|
|                                |                    |                    |  |
| Colour                         | 1 module           | 1 module           |  |
| <input type="checkbox"/> white | <b>MGU3.654.18</b> | <b>MGU3.655.18</b> |  |
| <input type="checkbox"/> ivory | <b>MGU3.654.25</b> | <b>MGU3.655.25</b> |  |
| 16 A 1P                        |                    |                    |  |
|                                |                    |                    |  |
| Colour                         | 1 module           |                    |  |
| <input type="checkbox"/> white | <b>MGU3.656.18</b> |                    |  |
| <input type="checkbox"/> ivory | <b>MGU3.656.25</b> |                    |  |
| 10 A 1P + N                    |                    | 16 A 1P + N        |  |
|                                |                    |                    |  |
| Colour                         | 2 modules          | 2 modules          |  |
| <input type="checkbox"/> white | <b>MGU3.614.18</b> | <b>MGU3.615.18</b> |  |
| <input type="checkbox"/> ivory | <b>MGU3.614.25</b> | <b>MGU3.615.25</b> |  |

### Residual current device (RCD) switches

| 6 A (IΔn 10 mA)                |                    | 10 A (IΔn 10 mA)   |  |
|--------------------------------|--------------------|--------------------|--|
|                                |                    |                    |  |
| Colour                         | 2 modules          | 2 modules          |  |
| <input type="checkbox"/> white | <b>MGU3.610.18</b> | <b>MGU3.611.18</b> |  |
| <input type="checkbox"/> ivory | <b>MGU3.610.25</b> | <b>MGU3.611.25</b> |  |
| 16 A (IΔn 10 mA)               |                    |                    |  |
|                                |                    |                    |  |
| Colour                         | 2 modules          |                    |  |
| <input type="checkbox"/> white | <b>MGU3.612.18</b> |                    |  |
| <input type="checkbox"/> ivory | <b>MGU3.612.25</b> |                    |  |

### Fuse holders

| 10 A  |                    | 16 A               |  |
|---|--------------------|--------------------|--|
|   |                    |                    |  |
| Colour  | 1 module           | 1 module           |  |
| <input type="checkbox"/> white                          | <b>MGU3.630.18</b> | <b>MGU3.632.18</b> |  |
| <input type="checkbox"/> ivory                          | <b>MGU3.630.25</b> | <b>MGU3.632.25</b> |  |
| For cylindrical fuses up to 10 A with dimensions 6x32mm |                    |                    |  |
| For 00 type fuses                                       |                    |                    |  |

## Comfort controls

### Rotary electronic dimmers switches

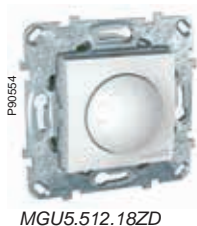

| 40-400 W/VA one/two way switch |                    | 60-400W/VA one way switch |  |
|--------------------------------|--------------------|---------------------------|--|
|                                |                    |                           |  |
| Colour                         | 2 modules          | 1 module                  |  |
| white                          | <b>MGU3.511.18</b> | <b>MGU3.559.18</b>        |  |
| ivory                          | <b>MGU3.511.25</b> | <b>MGU3.559.25</b>        |  |

One pulse to switch on (or off) and rotation to regulate load

| 400 VA, 1 - 10 V for fluorescent tubes |                    | 40 - 1000 W/VA       |  |
|--|--------------------|----------------------|--|
|  |                    |                      |  |
| Colour                                 | 2 modules          | 2 modules            |  |
| white                                  | <b>MGU3.510.18</b> | <b>MGU5.512.18ZD</b> |  |
| ivory                                  | <b>MGU3.510.25</b> | <b>MGU5.512.25ZD</b> |  |

- Max. control current: 200 mA
- Compliant with the interference suppression (EMC) standard EN 60669-2-1
- 4-wire connection

- Compliant with the interference suppression (EMC) standard EN 60669-2-1
- 3-wire connection

### Push-button dimmer switch

#### Multi-load Variapush (pulse control) 20 - 350 W/VA



|        |                    |
|--------|--------------------|
| Colour | 2 modules          |
| white  | <b>MGU3.515.18</b> |
| ivory  | <b>MGU3.515.25</b> |

Compliant with the interference suppression (EMC) standard EN 60669-2-1

|                    |                    |                    |                    |                    | Load table   |
|--------------------|--------------------|--------------------|--------------------|--------------------|--|
| <b>MGU3.511.XX</b> | <b>MGU3.559.XX</b> | <b>MGU3.510.XX</b> | <b>MGU5.512.XX</b> | <b>MGU3.515.XX</b> | <b>Maximum loads</b>   |
| 400 W              | 400 W              |                    | 1000 W             | 250 W              | 230 V AC incandescent lamps  |
| 400 W              | 400 W              |                    | 1000 W             | 350 W              | 230 V AC halogen lamps   |
| 400 VA             |                    |                    | 1000 VA            | 350 VA             | ELV halogen lamps with ferromagnetic transformer (non toroidal)  |
|                    |                    |                    |                    | 300 VA             | ELV lamps with toroidal transformer  |
|                    |                    |                    |                    | 350 VA             | ELV halogen lamps with electronic transformer  |
|                    |                    | 400 VA<br>1-10 V   |                    |                    | <ul style="list-style-type: none"> <li>• 230 V AC fluorescent tube, <math>\Phi</math> 26 or <math>\Phi</math> 38 mm with 1-10 V electronic ballast</li> <li>• 230 V AC fluorescent tube, 36 W with 10 electronic ballasts (1-10 V)</li> <li>• 230 V AC fluorescent tube, 2 x 16 W, <math>\Phi</math> 26 or <math>\Phi</math> 30 mm with 5 electronic ballasts (1-10 V)</li> <li>• Maximum control of 50 electronic ballasts (1-10 V) with an external relay</li> </ul> |
|                    |                    |                    |                    | 200 W              | 230 V AC fans  |
|                    |                    |                    |                    | 350 W              | 230 V AC convectors  |
|                    |                    |                    | 600 W              |                    | 230 V AC motors  |
|                    |                    |                    |                    |                    | <b>Installation</b>  |
|                    |                    |                    |                    |                    | Installed in place of a switch   |
|                    |                    |                    |                    |                    | May be controlled by push-buttons: up to 25 push-buttons in the surrounding area   |



MGU3.524.18



MGU3.525.18

## Movement and presence detectors

|        | 300 W detector     | 2300 W detector    |
|--------|--------------------|--------------------|
|        |                    |                    |
| Colour | 2 modules          | 2 modules          |
|        | <b>MGU3.524.18</b> | <b>MGU3.525.18</b> |
|        | <b>MGU3.524.25</b> | <b>MGU3.525.25</b> |

- Adjustable disconnection time and brightness
- Optional switching of the load connected to the control switch using conventional auxiliary push-buttons



MGU3.524.XX



MGU3.525.XX

## Load table

| MGU3.524.XX   | MGU3.525.XX                       |  |  |
|---|-----------------------------------|--|--|
| 300 W   | 2300 W                            |  | 230 V AC incandescent lamps                                  |
| 300 W   | 2000 W                            |  | 230 V AC halogen lamps                                       |
|   | 1050 VA                           |  | ELV halogen lamps with wire-wound transformer (non toroidal) |
|   | 1150 VA                           |  | ELV halogen lamps with electronic transformer                |
|   | 2000 VA<br>cos $\varphi \geq 0,9$ |  | 230 V AC fluorescent tube, $\Phi 26$ or $\Phi 38$ mm         |
|   | 500 VA                            |  | 230 V AC compact fluorescent lamps                           |
|   | 200 VA                            |  | 230 V AC fans  |
| 300 W<br>cos $\varphi \geq 0.95$                                  | 2300 W                            |  | 230 V AC convectors  |
|   | 200 VA                            |  | 230 V AC contactors  |
| <b>Installation</b>   |                                   |  |  |
| Parallel connection: max. 2 detectors for a load                  |                                   |  |  |
| Possibility of using up to 5 push-buttons in the surrounding area |                                   |  |  |



MGU3.501.18



MGU3.505.18



MGU3.503.18



MGU3.535.18



MGU3.541.18

## Thermostats

### 8 A basic thermostat



|         |                    |                    |
|---------|--------------------|--------------------|
| Colour  |                    | 2 modules          |
| □ white | <b>MGU3.501.18</b> | <b>MGU3.505.18</b> |
| ■ ivory | <b>MGU3.501.25</b> | <b>MGU3.505.25</b> |

Used to control heating and air conditioning according to pre-programmed times and temperatures

### 10 A floor thermostat



|             |                    |  |
|-------------|--------------------|--|
| Colour      |                    |  |
| ■ aluminium | <b>MGU3.503.18</b> |  |
| ■ graphite  | <b>MGU3.503.25</b> |  |

Delivered with 4m temperature sensor

## Time delay switch

### 8 A press activated time delay switch



|         |                    |           |
|---------|--------------------|-----------|
| Colour  |                    | 2 modules |
| □ white | <b>MGU3.535.18</b> |           |
| ■ ivory | <b>MGU3.535.25</b> |           |

- For all load types
- Adjustable disconnection time (2 s - 12 min.)
- Optional switching on using conventional push-button
- Included night blue locator lamp

## Weekly programmable timer

### Weekly programmable



|         |                    |           |
|---------|--------------------|-----------|
| Colour  |                    | 2 modules |
| □ white | <b>MGU3.541.18</b> |           |
| ■ ivory | <b>MGU3.541.25</b> |           |

- 230 V 1200 W (incandescent and halogen)
- 1000 VA (halogen 12 V with electromagnetic transformer)
- 28 intervals



MGU3.546.18



MGU3.545.18



MGU3.540.18



MGU3.283.18



MGU0.824



MGU3.710.18



MGU3.711.18



MGU3.713.18



MGU3.712



MGU3.716.18

## Weatherstation

### Weatherstation



Colour 2 modules

white **MGU3.546.18**

ivory **MGU3.546.25**

- Ambient temperature
- Atmospheric pressure
- Relative humidity

## Wake up clock

### Wake up clock



Colour 2 modules

white **MGU3.545.18**

ivory **MGU3.545.25**

- Double alarm
- "SNOOZE" function
- Indication of ambient temperature

## Key card switches

### 8 A timed



Colour 2 modules

white **MGU3.540.18**

ivory **MGU3.540.25**

### 10 A



Colour 2 modules

white **MGU3.283.18**

ivory **MGU3.283.25**

With locator lamp

### Supplementary lamp for key card switch



**MGU0.824**

## Technical alarms

### Detectors

#### Methane gas detectors - 12 V AC/DC



Colour 2 modules

white **MGU3.710.18**

ivory **MGU3.710.25**

#### LPG gas detectors - 12 V AC/DC



Colour 2 modules

white **MGU3.711.18**

ivory **MGU3.711.25**

#### Flood detectors - 12 V AC/DC



Colour 2 modules

white **MGU3.713.18**

ivory **MGU3.713.25**

#### Sensor for flood detectors



**MGU3.712** (white)

## Power supplies

### 230 V AC/ 12 V AC - 50/60 Hz



Colour 2 modules

white **MGU3.716.18**

ivory **MGU3.716.25**





## Socket-outlets

### German socket-outlets

#### 16 A 2P + E, shuttered, screwless



|        |                    |  |                      |
|--------|--------------------|--|----------------------|
| Colour | 2 modules          | 16 A 2P + E, shuttered, screwless, hinged flap | 2 modules            |
| white  | <b>MGU3.057.18</b> |  | <b>MGU3.057.18TA</b> |
| ivory  | <b>MGU3.057.25</b> |  | <b>MGU3.057.25TA</b> |
| red    | <b>MGU3.057.03</b> |  |                      |
| green  | <b>MGU3.057.06</b> |  |                      |

Side earth

#### 16 A 2P + E, shuttered, screwless with lamp



|        |                      |  |  |
|--------|----------------------|--|--|
| Colour | 2 modules            |  |  |
| white  | <b>MGU3.057.18SL</b> |  |  |
| red    | <b>MGU3.057.03SL</b> |  |  |

Side earth

#### 16 A 2P + E, screw terminals



|        |                    |  |                      |
|--------|--------------------|--|----------------------|
| Colour | 2 modules          | 16 A 2P + E, shuttered, screw terminals, hinged flap | 2 modules            |
| white  | <b>MGU3.036.18</b> |  | <b>MGU3.037.18TA</b> |
| ivory  | <b>MGU3.036.25</b> |  | <b>MGU3.037.25TA</b> |

Side earth

#### 16 A 2P + E, shuttered, screw terminals



|        |                    |   |                    |
|--------|--------------------|---|--------------------|
| Colour | 2 modules          | 16 A 45° 2P + E, shuttered, screw terminals | 2 modules          |
| white  | <b>MGU3.037.18</b> |   | <b>MGU3.040.18</b> |
| ivory  | <b>MGU3.037.25</b> |   | <b>MGU3.040.25</b> |
| red    | <b>MGU3.037.03</b> |   |                    |
| green  | <b>MGU3.037.06</b> |   |                    |
| orange | <b>MGU3.037.61</b> |   |                    |

Side earth

#### 16 A 2P + E, shuttered, screw terminals with lamp



|        |                      |  |  |
|--------|----------------------|--|--|
| Colour | 2 modules            |  |  |
| white  | <b>MGU3.037.18SL</b> |  |  |
| ivory  | <b>MGU3.037.25SL</b> |  |  |
| red    | <b>MGU3.037.03SL</b> |  |  |

Side earth

#### Only Unica Basic 16 A 2P + IP44 cover, screw terminals



|        |                     |  |  |
|--------|---------------------|--|--|
| Colour |                     |  |  |
| white  | <b>MGU61.037.18</b> |  |  |
| ivory  | <b>MGU61.037.25</b> |  |  |



MGU3.059.18



MGU3.059.25



MGU3.039.18



MGU3.039.25



MGU3.039.18SL



MGU3.030.18



MGU3.023.18



MGU3.045.18



MGU3.046.18

## French socket-outlets

### 16 A 2P + E, shuttered, screwless



Colour 2 modules

white MGU3.059.18

ivory MGU3.059.25

red MGU3.059.03

### 16 A 2P + E, shuttered, screw terminals



Colour 2 modules

white MGU3.039.18

ivory MGU3.039.25

red MGU3.039.03

### 16 A 2P + E, shuttered, screw terminals with lamp



Colour 2 modules

MGU3.039.18SL

MGU3.039.03SL

## Italian socket-outlets

### 10 A 2P + E, Italian earth, shuttered, screw terminals



Colour 1 module

white MGU3.030.18

### 16 A 2P + E, Italian earth, shuttered, screw terminals



Colour 1 module

white MGU3.023.18

ivory MGU3.023.25

## British socket-outlets

### 13 A 2P + E, shuttered, screw terminals



Colour 2 modules

white MGU3.045.18

ivory MGU3.045.25

### 15 A 2P + E, shuttered, screw terminals



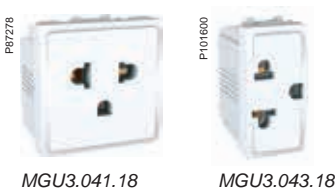
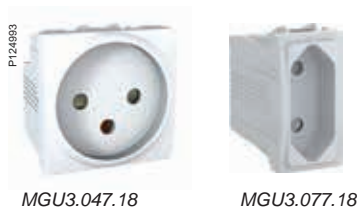

Colour 2 modules

MGU3.046.18



## Special socket-outlets

| 16 A 2P+E, shuttered, screw terminals |   | 10 A 2P, shuttered, screw terminals |   |
|---------------------------------------|---|-------------------------------------|---|
|                                       |  |                                     |  |
| Colour                                | 2 modules   |                                     | 1 module  |
| <input type="checkbox"/> white        | <b>MGU3.047.18</b>  |                                     | <b>MGU3.077.18</b>  |
| <input type="checkbox"/> ivory        | <b>MGU3.047.25</b>  |                                     | <b>MGU3.077.25</b>  |
| <input type="checkbox"/> red          | <b>MGU3.047.03</b>  |                                     |   |

## European socket-outlets



| 10 A 2P, shuttered, screw terminals |   |
|-------------------------------------|---|
|                                     |  |
| Colour                              | 1 module  |
| <input type="checkbox"/> white      | <b>MGU3.031.18</b>  |
| <input type="checkbox"/> ivory      | <b>MGU3.031.25</b>  |

Only for replacements in installations without an earthing connection

| 16 A 2P, shuttered, screw terminals |   |
|-------------------------------------|---|
|                                     |  |
| Colour                              | 2 modules   |
| <input type="checkbox"/> white      | <b>MGU3.033.18</b>  |
| <input type="checkbox"/> ivory      | <b>MGU3.033.25</b>  |

Only for replacements

## Euroamerican socket-outlets

| 2P, screw terminals            |   | 2P, shuttered, screw terminals |   |
|--------------------------------|---|--------------------------------|---|
|                                |  |                                |  |
| Colour                         | 1 module  |                                | 1 module  |
| <input type="checkbox"/> white | <b>MGU3.020.18</b>  |                                | <b>MGU3.021.18</b>  |
| <input type="checkbox"/> ivory | <b>MGU3.020.25</b>  |                                | <b>MGU3.021.25</b>  |

- 10 A - 250V AC for cylindrical pins
- 15 A - 125V AC for flat pins

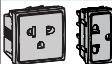
| 2P + E, screw terminals        |   | 2P + E, shuttered, screw terminals |   |
|--------------------------------|---|------------------------------------|---|
|                                |  |                                    |  |
| Colour                         | 2 modules   | 2 modules                          | 1 module  |
| <input type="checkbox"/> white | <b>MGU3.041.18</b>  | <b>MGU3.048.18</b>                 | <b>MGU3.043.18</b>  |
| <input type="checkbox"/> ivory | <b>MGU3.041.25</b>  |                                    |   |

- 10 A - 250V AC for cylindrical pins
- 15 A - 125V AC for flat pins

| 2P + E, shuttered, screw terminals |   |
|------------------------------------|---|
|                                    |  |
| Colour                             | 3 modules   |
| <input type="checkbox"/> white     | <b>MGU3.068.18</b>  |

- 10 A - 250V AC for cylindrical pins
- 15 A - 125V AC for flat pins

| 20 VA shaver socket, screw terminals |   |
|--------------------------------------|---|
|                                      |  |
| Colour                               | 3 modules   |
| <input type="checkbox"/> white       | <b>MGU5.064.18</b>  |

Input: 240 V, output: 115/240 V, 50 or 60 Hz, for shaver only



MGU3.027.18



MGU3.028.18



MGU3.061.18



MGU0.839.18

## American socket-outlets

### 15 A 2P + E, screw terminals



Colour 1 module

white **MGU3.027.18**

ivory **MGU3.027.25**

### 15 A 2P + E, shuttered, screw terminals



1 module

**MGU3.028.18**

### 15 A duplex 2P + E, shuttered, screw terminals

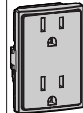

Colour 3 modules

white **MGU3.061.18**

ivory **MGU3.061.25**

## Socket-outlet centerplate with lamp

### For french socket-outlet



Colour 2 modules

white **MGU0.839.18**



MGU23.063.18



MGU23.065.18



MGU23.067.18

## Double socket-outlets Unica Basic

|                     | Unearthed, shuttered, screw terminals         | Unearthed, shuttered, screw terminals         |
|---------------------|---|---|
| Only<br>Unica Basic |   |   |
| Colour              | 2 modules                                     | 2 modules                                     |
| white               | <b>MGU23.063.18</b>                           | <b>MGU23.063.18D</b> (1)                      |
| ivory               | <b>MGU23.063.25</b>                           | <b>MGU23.063.25D</b> (1)                      |
|                     |   | DSO in pin pack                               |
| Only<br>Unica Basic | 2P + E, CZ/SK (2), shuttered, screw terminals | 2P + E, CZ/SK (2), shuttered, screw terminals |
|                     |   |   |
| Colour              | 2 modules                                     | 2 modules                                     |
| white               | <b>MGU23.065.18</b>                           | <b>MGU23.065.18D</b> (1)                      |
| ivory               | <b>MGU23.065.25</b>                           | <b>MGU23.065.25D</b> (1)                      |
|                     |   | DSO in pin pack                               |
| Only<br>Unica Basic | Side earth, shuttered, screw terminals        | Side earth, shuttered, screw terminals        |
|                     |   |   |
| Colour              | 2 modules                                     | 2 modules                                     |
| white               | <b>MGU23.067.18</b>                           | <b>MGU23.067.18D</b> (1)                      |
| ivory               | <b>MGU23.067.25</b>                           | <b>MGU23.067.25D</b> (1)                      |
|                     |   | DSO in pin pack                               |

- (1) ●●D: Individual packaging ; plastic bag and cardboard with eurohole
- (2) CZ/SK: Czech republic and Slovakia standard
- (3) PO/FR: Poland and France standard



MGU63.063.18



MGU63.065.18

## Double socket-outlets Unica Plus

### Unearthed, shuttered, screw terminals

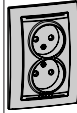

Only  
Unica Plus

| Colour       | white         | ivory         |
|--------------|---------------|---------------|
| white        | MGU63.063.18  |               |
| ivory        | MGU63.063.25  |               |
| Colour       | white         | ivory         |
| champagne    | MGU63.063.824 | MGU63.063.524 |
| indigo blue  | MGU63.063.842 |               |
| terracota    | MGU63.063.851 |               |
| glacial blue | MGU63.063.854 |               |
| apple green  | MGU63.063.863 | MGU63.063.563 |
| mist grey    | MGU63.063.865 |               |
| pistachio    | MGU63.063.866 |               |
| sand         | MGU63.063.867 | MGU63.063.567 |
| orange       | MGU63.063.869 |               |
| water green  | MGU63.063.870 |               |
| cacao        | MGU63.063.871 |               |
| garnet       | MGU63.063.872 |               |
| mink         | MGU63.063.874 |               |
| mauve        | MGU63.063.876 |               |

### 2P + E, CZ/SK (2), shuttered, screw terminals

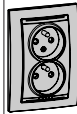

Only  
Unica Plus

| Colour        | white         | ivory         | white              | ivory              |
|---------------|---------------|---------------|--------------------|--------------------|
| white         | MGU63.065.18  |               | MGU63.065.18D (1)  |                    |
| ivory         | MGU63.065.25  |               | MGU63.065.25D (1)  |                    |
| Colour        | white         | ivory         | white              | ivory              |
| champagne     | MGU63.065.824 | MGU63.065.524 | MGU63.065.824D (1) | MGU63.065.524D (1) |
| indigo blue   |               |               | MGU63.065.842D (1) | MGU63.065.542D (1) |
| terracota     | MGU63.065.851 | MGU63.065.551 | MGU63.065.851D (1) | MGU63.065.551D (1) |
| glacial blue  | MGU63.065.854 | MGU63.065.554 | MGU63.065.854D (1) | MGU63.065.554D (1) |
| apple green   | MGU63.065.863 |               | MGU63.065.863D (1) | MGU63.065.563D (1) |
| mist grey     | MGU63.065.865 | MGU63.065.565 | MGU63.065.865D (1) | MGU63.065.565D (1) |
| pistachio     | MGU63.065.866 |               | MGU63.065.866D (1) | MGU63.065.566D (1) |
| sand          | MGU63.065.867 | MGU63.065.567 | MGU63.065.867D (1) | MGU63.065.567D (1) |
| orange        | MGU63.065.869 | MGU63.065.569 | MGU63.065.869D (1) | MGU63.065.569D (1) |
| water green   | MGU63.065.870 |               | MGU63.065.870D (1) |                    |
| cacao         | MGU63.065.871 | MGU63.065.571 | MGU63.065.871D (1) | MGU63.065.571D (1) |
| garnet        | MGU63.065.872 | MGU63.065.572 | MGU63.065.872D (1) | MGU63.065.572D (1) |
| maganese blue |               |               | MGU63.065.873D (1) |                    |
| mink          | MGU63.065.874 | MGU63.065.574 | MGU63.065.874D (1) | MGU63.065.574D (1) |
| mauve         | MGU63.065.876 |               | MGU63.065.876D (1) | MGU63.065.576D (1) |
| slate grey    | MGU63.065.877 | MGU63.065.577 | MGU63.065.877D (1) | MGU63.065.577D (1) |

DSO in pin pack

- (1) ●●D: Individual packaging ; plastic bag and cardboard with eurohole  
 (2) CZ/SK: Czech republic and Slovakia standard



MGU63.067.18



MGU63.069.18

## Double socket-outlets Unica Plus

|                 | Side earth, shuttered, screw terminals               |               | Side earth, shuttered, screw terminals |                    |
|-----------------|--|---------------|--|--------------------|
|                 |  |               |  |                    |
| Only Unica Plus |  |               |  |                    |
| Colour          |  |               |  |                    |
| □ white         | MGU63.067.18   |               | MGU63.067.18D (1)                      |                    |
| □ ivory         | MGU63.067.25   |               | MGU63.067.25D (1)                      |                    |
| Colour          | white  | ivory         | white                                  | ivory              |
| ■ champagne     | MGU63.067.824  | MGU63.067.524 | MGU63.067.824D (1)                     | MGU63.067.524D (1) |
| ■ indigo blue   | MGU63.067.842  |               |  |                    |
| ■ terracota     | MGU63.067.851  | MGU63.067.551 |  |                    |
| ■ glacial blue  | MGU63.067.854  | MGU63.067.554 |  |                    |
| ■ apple green   | MGU63.067.863  |               |  |                    |
| ■ mist grey     |  |               | MGU63.067.865D                         |                    |
| ■ pistachio     | MGU63.067.866  |               |  |                    |
| ■ sand          | MGU63.067.867  | MGU63.067.567 | MGU63.067.867D (1)                     |                    |
| ■ orange        | MGU63.067.869  |               |  |                    |
| ■ water green   | MGU63.067.870  |               | MGU63.067.870D (1)                     |                    |
| ■ cacao         | MGU63.067.871  | MGU63.067.571 |  |                    |
| ■ garnet        | MGU63.067.872  | MGU63.067.572 | MGU63.067.872D (1)                     |                    |
| ■ mauve         |  | MGU63.067.576 |  |                    |
| ■ slate grey    | MGU63.067.877  |               |  |                    |
|                 |  |               | DSO in pin pack                        |                    |
|                 | <b>2P + E, PO/FR (3), shuttered, screw terminals</b> |               |  |                    |
|                 |  |               |  |                    |
| Only Unica Plus |  |               |  |                    |
| Colour          |  |               |  |                    |
| □ white         | MGU63.069.18   |               |  |                    |
| □ ivory         | MGU63.069.25   |               |  |                    |
| Colour          | white  | ivory         |  |                    |
| ■ champagne     | MGU63.069.824  | MGU63.069.524 |  |                    |
| ■ indigo blue   | MGU63.069.842  |               |  |                    |
| ■ terracota     | MGU63.069.851  | MGU63.069.551 |  |                    |
| ■ glacial blue  | MGU63.069.854  |               |  |                    |
| ■ apple green   | MGU63.069.863  |               |  |                    |
| ■ mist grey     | MGU63.069.865  |               |  |                    |
| ■ pistachio     | MGU63.069.866  |               |  |                    |
| ■ sand          | MGU63.069.867  | MGU63.069.567 |  |                    |
| ■ orange        | MGU63.069.869  |               |  |                    |
| ■ water green   | MGU63.069.870  |               |  |                    |
| ■ cacao         | MGU63.069.871  |               |  |                    |
| ■ garnet        | MGU63.069.872  |               |  |                    |
| ■ maganese blue | MGU63.069.873  |               |  |                    |
| ■ mink          | MGU63.069.874  | MGU63.069.574 |  |                    |
| ■ mauve         | MGU63.069.876  |               |  |                    |
| ■ slate grey    | MGU63.069.877  |               |  |                    |

(1) ●●D: Individual packaging ; plastic bag and cardboard with eurohole  
 (3) PO/FR: Poland and France standard

## Data sockets

### RJ45 data sockets



| Category 5e, unshielded              |                            | Category 5e, shielded              |                            |                            |
|--------------------------------------|----------------------------|------------------------------------|----------------------------|----------------------------|
| Colour                               | 2 modules                  | 1 module                           | 2 modules                  | 1 module                   |
| white                                | MGU3.411.18 <sup>(1)</sup> | MGU3.410.18 <sup>(1)</sup>         | MGU3.413.18 <sup>(2)</sup> | MGU3.412.18 <sup>(2)</sup> |
| ivory                                | MGU3.411.25 <sup>(1)</sup> | MGU3.410.25 <sup>(1)</sup>         | MGU3.413.25 <sup>(2)</sup> | MGU3.412.25 <sup>(2)</sup> |
| Colour                               | 2 modules                  | 1 module                           | 2 modules                  | 1 module                   |
| white                                | MGU3.421.18 <sup>(1)</sup> | MGU3.420.18 <sup>(1)</sup>         | MGU3.423.18 <sup>(2)</sup> | MGU3.422.18 <sup>(2)</sup> |
| ivory                                | MGU3.421.25 <sup>(1)</sup> | MGU3.420.25 <sup>(1)</sup>         | MGU3.423.25 <sup>(2)</sup> | MGU3.422.25 <sup>(2)</sup> |
| Category 6, unshielded               |                            | Category 6, shielded               |                            |                            |
| Colour                               | 2 modules                  | 1 module                           | 2 modules                  | 1 module                   |
| white                                | MGU3.415.18 <sup>(3)</sup> | MGU3.414.18 <sup>(3)</sup>         | MGU3.417.18 <sup>(4)</sup> | MGU3.416.18 <sup>(4)</sup> |
| ivory                                | MGU3.415.25 <sup>(3)</sup> | MGU3.414.25 <sup>(3)</sup>         | MGU3.417.25 <sup>(4)</sup> | MGU3.416.25 <sup>(4)</sup> |
| Colour                               | 2 modules                  | 1 module                           | 2 modules                  | 1 module                   |
| white                                | MGU3.425.18 <sup>(3)</sup> | MGU3.424.18 <sup>(3)</sup>         | MGU3.427.18 <sup>(4)</sup> | MGU3.426.18 <sup>(4)</sup> |
| ivory                                | MGU3.425.25 <sup>(3)</sup> | MGU3.424.25 <sup>(3)</sup>         | MGU3.427.25 <sup>(4)</sup> | MGU3.426.25 <sup>(4)</sup> |
| Category 6 <sub>A</sub> , unshielded |                            | Category 6 <sub>A</sub> , shielded |                            |                            |
| Colour                               | 2 modules                  | 1 module                           | 2 modules                  | 1 module                   |
| white                                | MGU3.445.18 <sup>(5)</sup> | MGU3.444.18 <sup>(5)</sup>         | MGU3.447.18 <sup>(6)</sup> | MGU3.446.18 <sup>(6)</sup> |
| ivory                                | MGU3.445.25 <sup>(5)</sup> | MGU3.444.25 <sup>(5)</sup>         | MGU3.447.25 <sup>(6)</sup> | MGU3.446.25 <sup>(6)</sup> |



### RJ45 data connector covers

| LexCom    |             | Infraplus   |             |             |
|-----------|-------------|-------------|-------------|-------------|
| Colour    | 2 modules   | 1 module    | 2 modules   | 1 module    |
| white     | MGU9.421.18 | MGU9.420.18 | MGU9.411.18 | MGU9.410.18 |
| ivory     | MGU9.421.25 | MGU9.420.25 | MGU9.411.25 | MGU9.410.25 |
| Universal |             |             |             |             |
| Colour    | 2 modules   | 1 module    |             |             |
| white     | MGU9.460.18 | MGU9.461.18 |             |             |
| ivory     | MGU9.460.25 | MGU9.461.25 |             |             |

See technical information pages for compatibility table

Actassi S-one RJ45 connectors reference numbers included into Unica data sockets:

<sup>(1)</sup> VDIB17725U, <sup>(2)</sup> VDIB17725B, <sup>(3)</sup> VDIB17726U, <sup>(4)</sup> VDIB17726B, <sup>(5)</sup> VDIB1772XU, <sup>(6)</sup> VDIB1772XB.







## Optical fibre center plates

### Common characteristics

- Ambient air temperature for operation: 5 to 35 °C
- Standard: IEC 60874
- Degree of protection: IP20/ IK04.



|                                | SC/SC APC simplex type  | SC/SC APC duplex type   |
|--------------------------------|---|---|
| Colour                         |  |  |
| <input type="checkbox"/> white | <b>MGU9.439.18</b>  | <b>MGU9.438.18</b>  |
| <input type="checkbox"/> ivory |   | <b>MGU9.438.25</b>  |

- Support to receive any SC simplex and duplex adapters
- Support to receive **Actassy** optical fibre adapters:
  - SC Duplex multi mode adapters: ref. n° VDIB6031001 and VDIB6031002
  - SC Duplex single mode adapters: ref. n° VDIB6032001 and VDIB6032002
  - SC APC Duplex single mode adapter: ref. n° VDIB6082001
  - SC APC Simplex single mode adapter: ref. n° VDIB6072001.

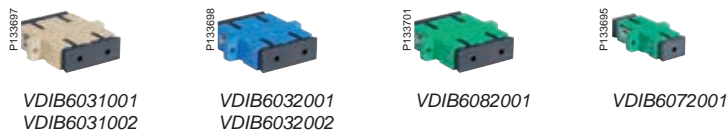

P87357



MGU3.451.18

P87360



MGU3.454.18

P140691



MGU3.450.18

P87371



MGU3.468.18

## TV/FM/SAT sockets

### TV/FM sockets

#### TV/FM socket for parallel distribution systems



|        |  |  |
|--------|--|--|
| Colour | 2 modules  | 2 modules  |
| white  | <b>MGU3.451.18</b>   | <b>MGU3.469.18</b>   |
| ivory  | <b>MGU3.451.25</b>   | <b>MGU3.469.25</b>   |
|        | <ul style="list-style-type: none"> <li>• 47-860MHz</li> <li>• Individual socket</li> </ul> | <ul style="list-style-type: none"> <li>• 47-860MHz with galvanic insulation individual socket</li> </ul> |

#### TV/FM sockets for series distribution systems



|        |  |   |
|--------|--|---|
| Colour | 2 modules  | 2 modules   |
| white  | <b>MGU3.452.18</b>   | <b>MGU3.453.18</b>  |
| ivory  | <b>MGU3.452.25</b>   | <b>MGU3.453.25</b>  |
|        | <ul style="list-style-type: none"> <li>• 47-860MHz</li> <li>• End-of-line (terminal socket)</li> </ul> | <ul style="list-style-type: none"> <li>• 47-860MHz</li> <li>• Intermediate socket (passage socket)</li> </ul> |

### R-TV/SAT sockets

#### R-TV/SAT socket for parallel distribution systems



|        |   |  |
|--------|---|--|
| Colour | 2 modules   | 2 modules  |
| white  | <b>MGU3.454.18</b>  | <b>MGU3.455.18</b>   |
| ivory  | <b>MGU3.454.25</b>  | <b>MGU3.455.25</b>   |
|        | <ul style="list-style-type: none"> <li>• 10-2400MHz</li> <li>• Individual socket</li> </ul> | <ul style="list-style-type: none"> <li>• 10-2400MHz</li> <li>• End-of-line (terminal)</li> </ul> |

#### R-TV/SAT socket for series distribution systems



|        |   |
|--------|---|
| Colour | 2 modules   |
| white  | <b>MGU3.456.18</b>  |
| ivory  | <b>MGU3.456.25</b>  |
|        | <ul style="list-style-type: none"> <li>• 10-2400MHz</li> <li>• Intermediate socket (passage)</li> </ul> |

### R/TV/SAT socket

#### R/TV/SAT socket for series distribution systems



|        |   |
|--------|---|
| Colour | 2 modules   |
| white  | <b>MGU3.450.18</b>  |
|        | <ul style="list-style-type: none"> <li>• R: 5-108 MHz / TV: 125-862 MHz / SAT: 950-2400 MHz</li> <li>• Individual socket</li> </ul> |

### TV/SAT sockets

#### TV/SAT Female socket-F type



|        |                    |
|--------|--------------------|
| Colour | 1 module           |
| white  | <b>MGU3.468.18</b> |
| ivory  | <b>MGU3.468.25</b> |



MGU3.462.18



MGU3.464.18



MGU3.465.18



MGU3.467.18





MGU9.440.18





MGU9.441.18



## SAT single shielded sockets

|                                | Male individual   | Male terminal   |
|--------------------------------|---|---|
|                                |  |  |
| Colour                         | 2 modules   | 2 modules   |
| <input type="checkbox"/> white | <b>MGU3.462.18</b>  | <b>MGU3.464.18</b>  |
| <input type="checkbox"/> ivory | <b>MGU3.462.25</b>  | <b>MGU3.464.25</b>  |
|                                | 5-2150 MHz  |   |
|                                | Male passage  |   |
|                                |  |   |
| Colour                         | 2 modules   |   |
| <input type="checkbox"/> white | <b>MGU3.463.18</b>  |   |
| <input type="checkbox"/> ivory | <b>MGU3.463.25</b>  |   |
|                                | 5-2150 MHz  |   |

## TV single shielded sockets

|                                | Female individual   | Female terminal   |
|--------------------------------|---|---|
|                                |    |  |
| Colour                         | 2 modules   | 2 modules   |
| <input type="checkbox"/> white | <b>MGU3.465.18</b>  | <b>MGU3.467.18</b>  |
| <input type="checkbox"/> ivory | <b>MGU3.465.25</b>  | <b>MGU3.467.25</b>  |
|                                | 5-862 MHz   |   |
|                                | Female passage  |   |
|                                |  |   |
| Colour                         | 2 modules   |   |
| <input type="checkbox"/> white | <b>MGU3.466.18</b>  |   |
| <input type="checkbox"/> ivory | <b>MGU3.466.25</b>  |   |
|                                | 5-862 MHz   |   |

## TV/FM/SAT cover plates

|                                | TV/FM   | R-TV/SAT  |
|--------------------------------|---|---|
|                                |  |  |
| Colour                         | 2 modules   | 2 modules   |
| <input type="checkbox"/> white | <b>MGU9.440.18</b>  | <b>MGU9.441.18</b>  |
| <input type="checkbox"/> ivory | <b>MGU9.440.25</b>  | <b>MGU9.441.25</b>  |



MGU3.492.18



MGU3.490.18



MGU3.497.18



MGU3.491.18



MGU3.499.18



MGU3.498.18



MGU3.775.18A



MGU3.775.18R



MGU3.775.18V



MGU3.775.18T



MGU0.821

## Telephone sockets

### RJ11 and RJ12

Screw connection. As per RD 1/1998 and RD 279/1999 (ICT): socket for the Terminal Access Database (TAD) for the telephony service.

#### RJ11- 4 contacts screw



| Colour | 2 modules   | 1 module    |
|--------|-------------|-------------|
| white  | MGU3.492.18 | MGU3.490.18 |
| ivory  | MGU3.492.25 | MGU3.490.25 |

#### RJ12- 6 contacts screw



| Colour | 2 modules   | 1 module    |
|--------|-------------|-------------|
| white  | MGU3.497.18 | MGU3.491.18 |
| ivory  | MGU3.497.25 | MGU3.491.25 |

#### RJ12- 6 contacts screwless

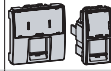

| Colour | 2 modules   | 1 module    |
|--------|-------------|-------------|
| white  | MGU3.493.18 | MGU3.495.18 |
| ivory  | MGU3.493.25 | MGU3.495.25 |

### British telephone sockets

#### 6 contacts screwless



| Colour | 1 module    |
|--------|-------------|
| white  | MGU3.499.18 |
| ivory  | MGU3.499.25 |

### Belgian telephone sockets

#### Belgacom type



| Colour | 2 modules   |
|--------|-------------|
| white  | MGU3.498.18 |
| ivory  | MGU3.498.25 |

## Indication

### Indicator lamps

#### Orange



| Colour | 1 module     |
|--------|--------------|
| white  | MGU3.775.18A |
| ivory  | MGU3.775.25A |

#### Red



| Colour | 1 module     |
|--------|--------------|
| white  | MGU3.775.18R |
| ivory  | MGU3.775.25R |

#### Green



| Colour | 1 module     |
|--------|--------------|
| white  | MGU3.775.18V |
| ivory  | MGU3.775.25V |

#### Colourless



| Colour | 1 module     |
|--------|--------------|
| white  | MGU3.775.18T |
| ivory  | MGU3.775.25T |

#### Neon lamp for indicator lamp



MGU0.821



MGU3.429.18



MGU3.430.18



MGU3.431.18



MGU3.432.18



MGU3.433.18

## Multimedia sockets

### USB data connectors

| USB data connector             |   |
|--------------------------------|---|
| Colour                         | 1 module  |
| <input type="checkbox"/> white | <b>MGU3.429.18</b>  |
| <input type="checkbox"/> ivory | <b>MGU3.429.25</b>  |
|                                | <ul style="list-style-type: none"> <li>• Output connectors: USB 2.0</li> <li>• Connection: screw terminals</li> <li>• Clamping connection capacity: up to 1.5 mm<sup>2</sup> rigid/stranded/flexible</li> <li>• Ambient air temperature for operation: - 5°C to + 40°C</li> <li>• Standards: IEC 998-1, IEC 998-2-1</li> <li>• Protection degrees: IP21/IK04</li> </ul> |

### HDMI sockets

| HDMI prewired socket           |  |
|--------------------------------|--|
| Colour                         | 1 module   |
| <input type="checkbox"/> white | <b>MGU3.430.18</b>   |
| <input type="checkbox"/> ivory | <b>MGU3.430.25</b>   |
|                                | <ul style="list-style-type: none"> <li>• Ambient air temperature for operation: - 5°C to + 40°C</li> <li>• Standards: EN 50157, EN 50049</li> <li>• Protection degrees: IP21/IK04</li> </ul> |

### RCA sockets

| 3 RCA female socket            |  |
|--------------------------------|--|
| Colour                         | 1 module   |
| <input type="checkbox"/> white | <b>MGU3.431.18</b>   |
| <input type="checkbox"/> ivory | <b>MGU3.431.25</b>   |
|                                | <ul style="list-style-type: none"> <li>• Connection: screw terminals</li> <li>• Clamping connection capacity: up to 1.5 mm<sup>2</sup> rigid/stranded/flexible</li> <li>• Ambient air temperature for operation: - 5°C to + 40°C</li> <li>• Protection degrees: IP21/IK04</li> </ul> |

### HD15 sockets

| HD15 female socket             |   |
|--------------------------------|---|
| Colour                         | 1 module  |
| <input type="checkbox"/> white | <b>MGU3.432.18</b>  |
| <input type="checkbox"/> ivory | <b>MGU3.432.25</b>  |
|                                | <ul style="list-style-type: none"> <li>• Ambient air temperature for operation: - 5°C to + 40°C</li> <li>• Protection degrees: IP21/IK04</li> </ul> |

### Mini jack sockets

| Mini jack 3.5 mm socket        |   |
|--------------------------------|---|
| Colour                         | 1 module  |
| <input type="checkbox"/> white | <b>MGU3.433.18</b>  |
| <input type="checkbox"/> ivory | <b>MGU3.433.25</b>  |
|                                | <ul style="list-style-type: none"> <li>• Ambient air temperature for operation: - 5°C to + 40°C</li> <li>• Protection degrees: IP21/IK04</li> </ul> |



MGU70.567.18



MGU70.566.18



MGU70.598

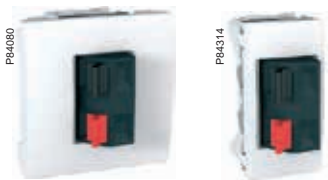

MGU3.486.18

MGU3.487.25



MGU3.428.18



MGU3.418.18

MGU3.418.25

## Bluetooth audio receivers

|                                | In-wall bluetooth audio receiver   | In-wall bluetooth audio receiver kit   |
|--------------------------------|--|--|
| Colour                         |  |  |
| <input type="checkbox"/> white | <b>MGU70.567.18</b>  | <b>MGU70.566.18</b>  |
| <input type="checkbox"/> ivory | <b>MGU70.567.25</b>  | <b>MGU70.566.25</b>  |
| Delivered with:                | <ul style="list-style-type: none"> <li>• audio receiver device</li> <li>• power supply</li> </ul>                      | <ul style="list-style-type: none"> <li>• audio receiver device</li> <li>• power supply</li> <li>• 2 loudspeakers</li> <li>• fixing frame with adaptor</li> </ul> |
| Characteristics:               | <ul style="list-style-type: none"> <li>• Audio receiver</li> <li>○ 2 modules</li> <li>○ voltage: 15-16 V DC</li> </ul> | <ul style="list-style-type: none"> <li>• Power supply</li> <li>○ voltage: 93-265 V AC</li> <li>○ frequency: 47-63 Hz</li> </ul>                                  |

## Loudspeakers and accessories

### Loudspeakers 2.5"

|   |
|---|
| <b>MGU70.598</b>  |
| <ul style="list-style-type: none"> <li>• 2 loudspeakers delivered with 2 cables (5 m, <math>\Phi</math> 0.5 mm<sup>2</sup>, red and white)</li> <li>• Dimensions (diameter x depth): 95 mm x 36 mm</li> <li>• Impedance: 8 <math>\Omega</math></li> </ul> |

### Loudspeaker socket

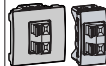

|                                | 2 modules          | 1 module           |
|--------------------------------|--------------------|--------------------|
| Colour                         |                    |                    |
| <input type="checkbox"/> white | <b>MGU3.486.18</b> | <b>MGU3.487.18</b> |
| <input type="checkbox"/> ivory | <b>MGU3.486.25</b> | <b>MGU3.487.25</b> |

Pressure-fixing of terminals

## USB chargers

### Single USB

|                                | 1 module   |
|--------------------------------|--|
| Colour                         |  |
| <input type="checkbox"/> white | <b>MGU3.428.18</b>   |
| <input type="checkbox"/> ivory | <b>MGU3.428.25</b>   |
| Delivered with:                | <ul style="list-style-type: none"> <li>• Nominal input voltage: 100-240 V AC <math>\pm</math>10 %</li> <li>• USB output voltage: 5 V DC <math>\pm</math> 5 %</li> <li>• Nominal output current: 1 A</li> <li>• Power consumption: &lt; 0.1 W (in stand-by)</li> <li>• Maximum output power: 7.5 W</li> <li>• Overvoltage category: OVC III</li> <li>• Isolation class: class II</li> </ul> |

### Double USB charger 2.1 A

|                                | 2 modules   |
|--------------------------------|---|
| Colour                         |   |
| <input type="checkbox"/> white | <b>MGU3.418.18</b>  |
| <input type="checkbox"/> ivory | <b>MGU3.418.25</b>  |
| Delivered with:                | <ul style="list-style-type: none"> <li>• Nominal input voltage: 100-240 V AC <math>\pm</math>10 %</li> <li>• USB output voltage: 5 V DC <math>\pm</math> 5 %</li> <li>• Nominal output current: 1 x 2.1 A (only left output) or 2 x 1.05 A (for 2 outputs)</li> <li>• Power consumption: &lt; 0.1 W (in stand-by)</li> <li>• Maximum output power: 10.5 W</li> <li>• Expected lifetime: 30 000 h for output power 10.5 W</li> <li>• Overvoltage category: OVC III</li> <li>• Isolation class: class II</li> </ul> |





MGU3.785.18



MGU3.786.18

## Buzzer and electronic doorbell

|                                | 230 V, 50-60Hz buzzer   | 230 V electronic doorbell   |
|--------------------------------|---|---|
|                                |  |  |
| Colour                         | 2 modules   | 2 modules   |
| <input type="checkbox"/> white | <b>MGU3.785.18</b>  | <b>MGU3.786.18</b>  |
| <input type="checkbox"/> ivory | <b>MGU3.785.25</b>  | <b>MGU3.786.25</b>  |
|                                | With adjustable tone  | 5 tunes   |



MGU3.776.T



MGU3.780.T

## Emergency light

| Emergency light   |
|---|
|  |
| 2 modules   |
| <b>MGU3.776.T</b>   |

## Pilotlamp

| Autonomous pilotlamp  |
|---|
|  |
| 2 modules   |
| <b>MGU3.780.T</b>   |

## Complementary offers

### Cable outlet

16 A



| Colour | 2 modules          | 1 module           |
|--------|--------------------|--------------------|
| white  | <b>MGU3.862.18</b> | <b>MGU3.860.18</b> |
| ivory  | <b>MGU3.862.25</b> | <b>MGU3.860.25</b> |

- 3 x 2.5mm<sup>2</sup> connection terminals
- Anti-tug clamps

### Blind cover plates

#### Blind cover plate



| Colour | 2 modules          | 1 module           | 1/2 module         |
|--------|--------------------|--------------------|--------------------|
| white  | <b>MGU9.866.18</b> | <b>MGU9.865.18</b> | <b>MGU9.864.18</b> |
|        | <b>MGU9.866.25</b> | <b>MGU9.865.25</b> | <b>MGU9.864.25</b> |

#### Blind cover plate with groove



| Colour | 1 module           |
|--------|--------------------|
| white  | <b>MGU9.868.18</b> |
| ivory  | <b>MGU9.868.25</b> |

### Rockers

#### Rocker with light symbol



| Colour | 2 modules           | 1 module            |
|--------|---------------------|---------------------|
| white  | <b>MGU9.200.18L</b> | <b>MGU9.100.18L</b> |
| ivory  | <b>MGU9.200.25L</b> | <b>MGU9.100.25L</b> |

#### Rocker with fan symbol



| Colour | 1 module            | 2 modules           | 1 module              |
|--------|---------------------|---------------------|-----------------------|
| white  | <b>MGU9.200.18V</b> | <b>MGU9.100.18V</b> | <b>MGU9.200.18VMC</b> |
| ivory  | <b>MGU9.200.25V</b> | <b>MGU9.100.25V</b> | <b>MGU9.200.25VMC</b> |

#### Rocker with boiler symbol



| Colour | 2 modules              | 1 module               |
|--------|------------------------|------------------------|
| white  | <b>MGU9.200.18BOIL</b> | <b>MGU9.100.18BOIL</b> |
| ivory  | <b>MGU9.200.25BOIL</b> | <b>MGU9.100.25BOIL</b> |

#### Rocker with heater symbol



| Colour | 2 modules           | 1 module            |
|--------|---------------------|---------------------|
| white  | <b>MGU9.200.18H</b> | <b>MGU9.100.18H</b> |
| ivory  | <b>MGU9.200.25H</b> | <b>MGU9.100.25H</b> |



MGU3.862.18



MGU3.860.18



MGU9.866.18



MGU9.865.18



MGU9.200.18L



MGU9.100.18L



MGU9.200.18V



MGU9.100.18VMC



MGU9.200.18BOIL



MGU9.100.18BOIL



MGU9.200.18H



MGU9.100.18H





## Emitters

### Battery powered push-button

|         | For Unica Basic and Unica Colors cover frames | For Unica Plus cover frames |
|---------|---|-----------------------------|
| Colour  |   |                             |
| □ white | <b>MGU84.071.18</b>                           | <b>MGU86.071.18</b>         |
| ■ ivory | <b>MGU84.071.25</b>                           | <b>MGU86.071.25</b>         |

- Can control wireless receivers for light and/or roller blinds
- Supplied with a lithium battery, 1 large cover (2 modules), 2 narrow covers (2 x 1 modules) and a set of symbols. Flat fixing frame integrated to the product

## Combined modules

### Combined relay (on/off)

|         | With neutral       |
|---------|--------------------|
| Colour  |                    |
| □ white | <b>MGU3.572.18</b> |
| ■ ivory | <b>MGU3.572.25</b> |

- Supplied with 1 large cover (2 modules) and 2 narrow covers (2 x 1 modules)
- Wireless receiver and emitter in one single product

### Combined dimmer

|         | Without neutral    |
|---------|--------------------|
| Colour  |                    |
| □ white | <b>MGU3.573.18</b> |
| ■ ivory | <b>MGU3.573.25</b> |

- Supplied with 1 large cover (2 modules) and 2 narrow covers (2 x 1 module)
- Wireless receiver and emitter in one single product

### Combined roller blind

|         | With neutral       |
|---------|--------------------|
| Colour  |                    |
| □ white | <b>MGU3.574.18</b> |
| ■ ivory | <b>MGU3.574.25</b> |

- Supplied with 1 large cover (2 modules) and 2 narrow covers (2 x 1 module)
- Wireless receiver and emitter in one single product





## Combined modules load table

| MGU3.572.XX | MGU3.573.XX | MGU3.574.XX | Loads  |
|-------------|-------------|-------------|--|
| 2300 W      | 20 - 315 W  |             | 230 V AC incandescent lamps  |
| 2000 W      | 20 - 315 W  |             | 230 V AC halogen lamps   |
| 500 VA      | 20 - 315 VA |             | 230 V/12 V AC halogen lamps with ferromagnetic transformer (non toroidal)<br>230 V/12 V AC halogen lamps with electronic transformer |
| 500 VA      | 20 - 270 VA |             | 230 V/12 V AC halogen lamps with toroidal transformer  |
| 920 VA      |             |             | 230 V AC fluorescent tubes $\Phi$ 28 or $\Phi$ 38 mm (48 $\mu$ F)  |
| 880 VA      |             |             | 230 V AC compact fluorescent lamps   |
| 880 W       |             |             | 230 V AC LED lamps   |
| 690 VA      |             |             | 230 V AC single phase motors and ventilators   |
|             |             | 690 W       | 230 V AC single phase tubular motors for roller blind (with or without limit switches)   |

## Receivers

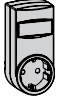

### Mobile socket-outlets relay (On/Off)













|                                | German type mobile socket-outlet  | French type mobile socket-outlet  |
|--------------------------------|---|---|
|                                |  |  |
| Colour                         |   |   |
| <input type="checkbox"/> white | <b>CCT1A020</b>   | <b>CCT1A022</b>   |
|                                | With one key for local control (switch)   |   |

### Mobile socket-outlets dimmer



|                                | German type mobile socket-outlet  | French type mobile socket-outlet  |
|--------------------------------|---|---|
|                                |  |  |
| Colour                         |   |   |
| <input type="checkbox"/> white | <b>CCT1A021</b>   | <b>CCT1A023</b>   |
|                                | With one key for local control (dimmer)   |   |

### Mobile socket-outlets load table

|                        |  CCT1A020<br>CCT1A022 |  CCT1A021<br>CCT1A023 | Loads   |
|------------------------|---|---|---|
| 2300 W                 | 250 W   |   |    230 V AC incandescent lamps and halogen lamps |
| 1840 VA                | 250 VA  |   |   230/12 V AC halogen lamps with ferromagnetic transformer (non toroidal) or with electronic transformer                            |
| 1840 VA<br>cos φ ≥ 0,9 |   |   |  230 V AC fluorescent tubes Φ 28 or Φ 38 mm (100 μF)   |
| 1840 VA                |   |   |  230 V AC compact fluorescent lamps  |
| 1840 W                 |   |   |  230 V AC LED lamps  |
| 1380 W                 |   |   |  230 V AC motors, ventilators  |



CCT1A000



CCT1A010



CCT1A030



CCT1A031

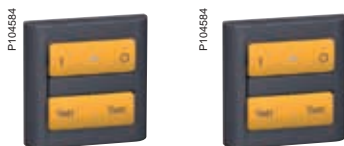

CCT1A090



MGU0.570.18

## Remote controls

### Metal remote control

#### 8 keys to be customized



|             |   |
|-------------|---|
| Colour      |   |
| ■ dark grey | <b>CCT1A000</b>   |
|             | <ul style="list-style-type: none"> <li>• Can control lights or/and roller blinds</li> <li>• 8 keys to program in simple mode and scenario mode</li> <li>• Supplied with 2 AAA batteries and 32 symbols</li> </ul> |

### Keyring remote control

#### 4 keys



|             |  |
|-------------|--|
| Colour      |  |
| ■ dark grey | <b>CCT1A010</b>  |
|             | <ul style="list-style-type: none"> <li>• 4 keys to control lights and/or roller blinds</li> <li>• Convenient design to be used as a keyring or to be placed in a pocket</li> <li>• Supplied with Lithium CR2032 batteries</li> </ul> |

## Complementary offer

### Universal modules

#### Universal emitter



|         |  |
|---------|--|
| □ white | <b>CCT1A030</b>  |
|         | <ul style="list-style-type: none"> <li>• Converts mechanical push-button into a wireless emitter</li> <li>• 4 RF channels</li> <li>• Supplied with a lithium battery</li> <li>• Never use switches, only push-buttons</li> </ul> |

#### Universal receiver relay



|        |  |
|--------|--|
| ■ grey | <b>CCT1A031</b>  |
|        | <ul style="list-style-type: none"> <li>• Flush mounted or hidden in the ceiling</li> <li>• Light: 10 A max.</li> <li>• Engine: 3 A max.</li> </ul> |

### Test kit

#### RF signal tester



|             |   |
|-------------|---|
| ■ dark grey | <b>CCT1A090</b>   |
|             | Kit content: 2 testers to check the quality of the RF signal transmission between two product locations |

### Accessories

#### Set of scenario symbols

|         |  |
|---------|--|
| Colour  |  |
| □ white | <b>MGU0.570.18</b>   |
| ■ ivory | <b>MGU0.570.25</b>   |
|         | Set content: 2x cooking, 2x diner, 2x little light, 2x much light, 2x at home, 2x leaving home, 2x TV, 2x empty. |

The following Unica control devices have to be connected to KNX bus line.

The KNX bus line is laid in parallel to the 230 V power supply.

When Unica sensor is activated (for example, a push-button), an actuator (e.g. the roller shutter control) will carry out all the switching commands required.

## Introduction

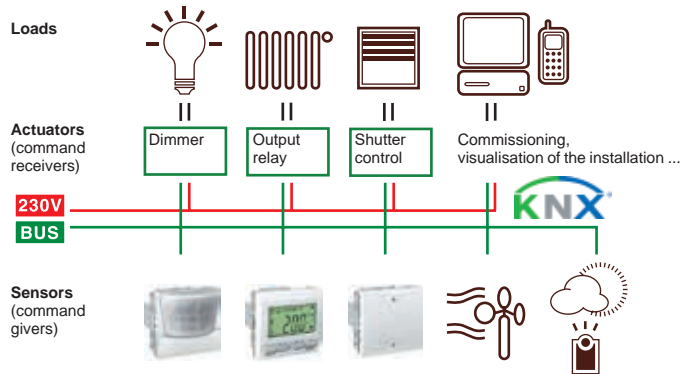

## Controls

### Push-buttons

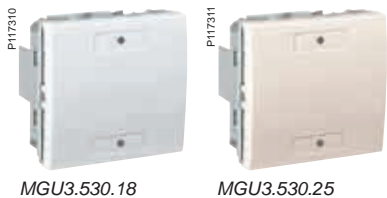

**2 buttons and 2 blue status LEDs, with screwless bus connecting terminals**



|        |                    |
|--------|--------------------|
| Colour | 2 modules          |
| white  | <b>MGU3.530.18</b> |
| ivory  | <b>MGU3.530.25</b> |

- The status LED is located under the symbol window which can be taken off.
- With integrated bus coupler. The bus is connected using a bus connecting terminal.
- Contents:**
  - With set of 10 symbols:
    - 2x symbol with light opening,
    - 1x symbol "1",
    - 1x symbol "0",
    - 2x symbol for dimming,
    - 2x symbol for shutter,
    - 2x symbol (neutral).
  - With bus connecting terminal.

**4 buttons and 4 blue status LEDs, with screwless bus connecting terminals**



|        |                    |
|--------|--------------------|
| Colour | 2 modules          |
| white  | <b>MGU3.531.18</b> |
| ivory  | <b>MGU3.531.25</b> |

- The status LED is located under the symbol window which can be taken off.
- With integrated bus coupler. The bus is connected using a bus connecting terminal.
- Contents:**
  - With set of 20 symbols:
    - 4x symbol with light opening,
    - 2x symbol "1",
    - 2x symbol "0",
    - 4x symbol for dimming,
    - 4x symbol for shutter,
    - 4x symbol (neutral).
  - With bus connecting terminal.

**KNX software functions:** Switching, toggling, dimming (single/dual-surface), blind (single/dual-surface), pulse edges trigger 1-, 2-, 4- or 8-bit telegrams (distinction between short and long operation), pulse edges with 2-byte telegrams (distinction between short and long operation), 8-bit linear regulator, scene retrieval, scene saving, disable functions.

**2 buttons, blue status LED and Infra Red (IR) receiver, with screwless bus connecting terminals**



|        |                    |
|--------|--------------------|
| Colour | 2 modules          |
| white  | <b>MGU3.532.18</b> |
| ivory  | <b>MGU3.532.25</b> |

- The status LED is located under the symbol window which can be taken off.
- The functions of each of the button can be triggered using an IR remote control. The push-button is pre-programmed for operation with a Schneider-Electric IR remote control Distance. Many other IR remote controls (e.g. existing TV or CD player remote controls) can be taught into the push-buttons.
- With integrated bus coupler. The bus is connected using a bus connecting terminal.
- Transmitter: IR remote control Distance, ref. MTN570222.
- Contents: With bus connecting terminal.

**KNX software functions:** Switching, toggling, dimming (single/dual-surface), blind (single/dual-surface), pulse edges trigger 1-, 2-, 4- or 8-bit telegrams (distinction between short and long operation), pulse edges with 2-byte telegrams (distinction between short and long operation), 8-bit linear regulator, scene retrieval, scene saving, disable functions.

**Infra Red (IR) remote control for IR push-button receiver**



|        |                  |
|--------|------------------|
| Colour | 1 module         |
| black  | <b>MTN570222</b> |

- 10-channel IR remote control
- Battery: 2 microcells (IEC LR 03, AAA)
- Range: up to 20 m
- Contents: without battery.

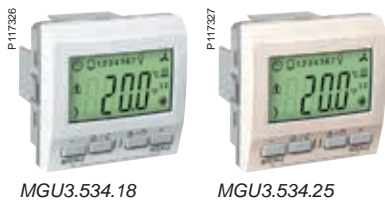
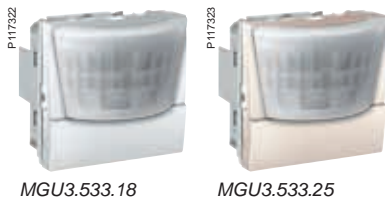

## Comfort controls

### Movement detector, with screwless bus connecting terminals



Colour 2 modules

white **MGU3.533.18**

ivory **MGU3.533.25**

When a movement is detected, a data telegram defined by the programming is transmitted.

- Two movement sensors: the sensitivity and range can be set separately for each sensor
- Detection angle: 180°
- Installation height : 1 m to 2.5 m
- Detection area at 2.15 m mounting height : Approx. 9 m on all sides, adjustable in 10 steps (rotary switch or ETS)
- Detection brightness: Infinite setting from approx. 10 lux to approx.1000 lux (rotary switch) or from 10 lux to 2000 lux (ETS)
- Overshoot time: Adjustable in 6 steps from approx. 1 s to approx. 8 min (rotary switch) or adjustable from 1 s to 255 hours (ETS)
- EC guidelines: Low-voltage guideline 2006/95/EEC and EMC guideline 2004/108/EC
- With bus connecting terminal. The bus is connected using a bus connecting terminal.

**KNX software functions:** 5 movement blocks: up to 4 functions can be triggered per block.  
Telegrams: 1 bit, 1 byte, 2 bytes.

### Room temperature control unit, with screwless bus connecting terminals



Colour 2 modules

white **MGU3.534.18**

ivory **MGU3.534.25**

- With display and 4 buttons
  - 2-step control, continuous PI controller, switching PI controller (PWM)
  - Output: continuous in the range 0 to 100% or switching ON/OFF
  - Controller mode:
    - Heating with one controller output
    - Cooling with one controller output
    - Heating and cooling with separate controller outputs
    - Heating and cooling with one controller output
    - 2-step heating with 2 control outputs
    - 2-step cooling with 2 control outputs
    - 2-step heating and cooling with 4 control outputs
  - Operating modes: Comfort, comfort extension, standby, night reduction, frost/heat protection
- Move all setpoints, save all setpoint temperatures and operating modes when reset, external temperature monitoring, additional output of the control value as 1 byte value on the PWM.  
With bus connecting terminal. The bus is connected using a bus connecting terminal.

For more information on functions and products in association with KNX, go to Schneider Electric KNX catalogue.



MGU7.002



MGU7.004.P

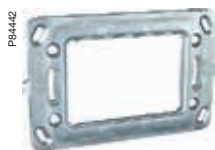

MGU7.103

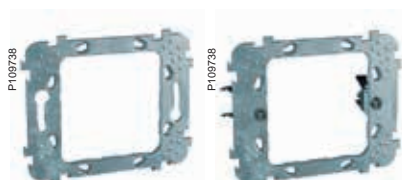

MGU7.012

MGU7.012.GL

## Universal fixing frames

### Fixing frame without claws



Type 1 gang

zamak **MGU7.002**

plastic **MGU7.002.P**

For attachable universal box

### Fixing frame with short fixed claws



Type 1 gang

zamak **MGU7.002.GG**

plastic

For attachable universal box

### Fixing frame with long fixed claws



1 gang

**MGU7.002.GL**

**MGU7.002.GLS** (1)

**MGU7.002.PGL**

(1) Stainless claws

### Fixing frame without claws



Type 2 gang

plastic **MGU7.004.P**

For attachable universal box

### Short claw with plastic protection



**MGU7.892**

Set of 20 units

## Italian fixing frames

### Italian fixing frames



Type 3 modules

zamak **MGU7.103**

plastic **MGU7.103.P**

### Italian fixing frames



4 modules

**MGU7.104**

**MGU7.104.P**

### Italian fixing frame



6 modules

**MGU7.106**

## 57 mm interaxis fixing frames

### Fixing frames without claws



Type 1 gang

zamak **MGU7.012**

### Fixing frames with long stainless claws



1 gang

**MGU7.012.GLS**

### Extension for long claws



**MGU7.892.A**

Set of 20 units, to be assembled with long claws



MGU8.002.18



MGU87.022.18



MGU8.103.18



ENN35303

ENN37303



MGU22.302.18



MGU22.304.18



MGU8.624



MGU8.601

## Surface mounting boxes

|                                     | Boxes   |   |                     |
|-------------------------------------|---|---|---------------------|
| Only<br>Unica Basic<br>Unica Colors |   |   |                     |
| Colour                              | 1 gang  | 2 gang                                  | 3 gang              |
| <input type="checkbox"/> white      | <b>MGU8.002.18</b>  | <b>MGU8.004.18</b>                      | <b>MGU8.006.18</b>  |
| <input type="checkbox"/> ivory      | <b>MGU8.002.25</b>  | <b>MGU8.004.25</b>                      | <b>MGU8.006.25</b>  |
|                                     | Boxes with clip-on fixing frame   |   |                     |
| Only<br>Unica Plus                  |   |   |                     |
| Colour                              | 1 gang  | 2 gang                                  | 3 gang              |
| <input type="checkbox"/> white      | <b>MGU87.022.18</b>   | <b>MGU87.024.18</b>                     | <b>MGU87.026.18</b> |
| <input type="checkbox"/> ivory      | <b>MGU87.022.25</b>   | <b>MGU87.024.25</b>                     | <b>MGU87.026.25</b> |
|                                     | Italian boxes   |   |                     |
| Only<br>Unica Allegro               |   |   |                     |
| Colour                              | 3 modules   | 4 modules                               |                     |
| <input type="checkbox"/> white      | <b>MGU8.103.18</b>  | <b>MGU8.104.18</b>                      |                     |
| <input type="checkbox"/> ivory      | <b>MGU8.103.25</b>  | <b>MGU8.104.25</b>                      |                     |
|                                     | IP 55 monobloc box  | IP 55 box cover                         |                     |
|                                     | <b>ENN35303</b>   | <b>ENN37303</b>                         |                     |
|                                     | - for devices with rigid hinged flap<br>- built in framework and surface mounted box<br>- 20 mm diameter (use the sign for diameter instead) cable inlet. | To combine with the IP55 Surface boxes. |                     |

## Boxes and cover frames

|                                     | 1 gang complete assembly     | 2 gang complete assembly |
|-------------------------------------|------------------------------|--------------------------|
| Only<br>Unica Basic<br>Unica Colors |                              |                          |
| Colour                              |                              |                          |
| <input type="checkbox"/> white      | <b>MGU22.302.18</b>          | <b>MGU22.304.18</b>      |
| <input type="checkbox"/> ivory      | <b>MGU22.302.25</b>          | <b>MGU22.304.25</b>      |
|                                     | Cover and fixing frame + box |                          |

## Flush mounting boxes

|                     | Flush mounting boxes          |                 | Italian flush mounting boxes |                 |
|---------------------|-------------------------------|-----------------|------------------------------|-----------------|
|                     |                               |                 |                              |                 |
|                     | 2 x 4 modules                 | 2 x 6 modules   | 3 modules                    | 4 modules       |
|                     | <b>MGU8.624</b>               | <b>MGU8.626</b> | <b>MGU8.603</b>              | <b>MGU8.604</b> |
|                     | Insulated box for thin panels |                 |                              |                 |
| Only<br>Unica Basic |                               |                 |                              |                 |
|                     | <b>MGU8.601</b>               |                 |                              |                 |

# Unica Plus





# Unica Plus aesthetics



P104900



P84936

Bright chrome .x10



P84944

Champagne .x24



P84941

Cacao .x71



P84946

Gold .x04



P84929

Pistachio .x66



P84838

Apple green .x63



P84931

Garnet .x72



P84933

Slate grey .x77



## 1 gang



| Colour                                  | <input type="checkbox"/> white | <input type="checkbox"/> ivory |
|---|--------------------------------|--------------------------------|
| <input type="checkbox"/> white          | <b>MGU6.002.18</b>             |                                |
| <input type="checkbox"/> ivory          |                                | <b>MGU6.002.25</b>             |
| <input type="checkbox"/> champagne      | <b>MGU6.002.824</b>            | <b>MGU6.002.524</b>            |
| <input type="checkbox"/> indigo blue    | <b>MGU6.002.842</b>            | <b>MGU6.002.542</b>            |
| <input type="checkbox"/> terracotta     | <b>MGU6.002.851</b>            | <b>MGU6.002.551</b>            |
| <input type="checkbox"/> glacier blue   | <b>MGU6.002.854</b>            | <b>MGU6.002.554</b>            |
| <input type="checkbox"/> apple green    | <b>MGU6.002.863</b>            | <b>MGU6.002.563</b>            |
| <input type="checkbox"/> mist grey      | <b>MGU6.002.865</b>            | <b>MGU6.002.565</b>            |
| <input type="checkbox"/> pistachio      | <b>MGU6.002.866</b>            | <b>MGU6.002.566</b>            |
| <input type="checkbox"/> sand           | <b>MGU6.002.867</b>            | <b>MGU6.002.567</b>            |
| <input type="checkbox"/> orange         | <b>MGU6.002.869</b>            | <b>MGU6.002.569</b>            |
| <input type="checkbox"/> water green    | <b>MGU6.002.870</b>            | <b>MGU6.002.570</b>            |
| <input type="checkbox"/> cacao          | <b>MGU6.002.871</b>            | <b>MGU6.002.571</b>            |
| <input type="checkbox"/> garnet         | <b>MGU6.002.872</b>            | <b>MGU6.002.572</b>            |
| <input type="checkbox"/> manganese blue | <b>MGU6.002.873</b>            | <b>MGU6.002.573</b>            |
| <input type="checkbox"/> mink           | <b>MGU6.002.874</b>            | <b>MGU6.002.574</b>            |
| <input type="checkbox"/> mauve          | <b>MGU6.002.876</b>            | <b>MGU6.002.576</b>            |
| <input type="checkbox"/> slate grey     | <b>MGU6.002.877</b>            | <b>MGU6.002.577</b>            |
| <input type="checkbox"/> bright chrome  | <b>MGU66.002.810</b>           | <b>MGU66.002.510</b>           |
| <input type="checkbox"/> gold           | <b>MGU66.002.804</b>           | <b>MGU66.002.504</b>           |

## 2 gang horizontal installation



| Colour                                  | <input type="checkbox"/> white | <input type="checkbox"/> ivory |
|---|--------------------------------|--------------------------------|
| <input type="checkbox"/> white          | <b>MGU6.004.18</b>             |                                |
| <input type="checkbox"/> ivory          |                                | <b>MGU6.004.25</b>             |
| <input type="checkbox"/> champagne      | <b>MGU6.004.824</b>            | <b>MGU6.004.524</b>            |
| <input type="checkbox"/> indigo blue    | <b>MGU6.004.842</b>            | <b>MGU6.004.542</b>            |
| <input type="checkbox"/> terracotta     | <b>MGU6.004.851</b>            | <b>MGU6.004.551</b>            |
| <input type="checkbox"/> glacier blue   | <b>MGU6.004.854</b>            | <b>MGU6.004.554</b>            |
| <input type="checkbox"/> apple green    | <b>MGU6.004.863</b>            | <b>MGU6.004.563</b>            |
| <input type="checkbox"/> mist grey      | <b>MGU6.004.865</b>            | <b>MGU6.004.565</b>            |
| <input type="checkbox"/> pistachio      | <b>MGU6.004.866</b>            | <b>MGU6.004.566</b>            |
| <input type="checkbox"/> sand           | <b>MGU6.004.867</b>            | <b>MGU6.004.567</b>            |
| <input type="checkbox"/> orange         | <b>MGU6.004.869</b>            | <b>MGU6.004.569</b>            |
| <input type="checkbox"/> water green    | <b>MGU6.004.870</b>            | <b>MGU6.004.570</b>            |
| <input type="checkbox"/> cacao          | <b>MGU6.004.871</b>            | <b>MGU6.004.571</b>            |
| <input type="checkbox"/> garnet         | <b>MGU6.004.872</b>            | <b>MGU6.004.572</b>            |
| <input type="checkbox"/> manganese blue | <b>MGU6.004.873</b>            | <b>MGU6.004.573</b>            |
| <input type="checkbox"/> mink           | <b>MGU6.004.874</b>            | <b>MGU6.004.574</b>            |
| <input type="checkbox"/> mauve          | <b>MGU6.004.876</b>            | <b>MGU6.004.576</b>            |
| <input type="checkbox"/> slate grey     | <b>MGU6.004.877</b>            | <b>MGU6.004.577</b>            |
| <input type="checkbox"/> bright chrome  | <b>MGU66.004.810</b>           | <b>MGU66.004.510</b>           |
| <input type="checkbox"/> gold           | <b>MGU66.004.804</b>           | <b>MGU66.004.504</b>           |



MGU6.004V.18



MGU6.006.18

### 2 gang vertical installation



| Colour         | white                 | ivory                 |
|----------------|-----------------------|-----------------------|
| white          | <b>MGU6.004V.18</b>   |                       |
| ivory          |                       | <b>MGU6.004V.25</b>   |
| champagne      | <b>MGU6.004V.824</b>  | <b>MGU6.004V.524</b>  |
| indigo blue    | <b>MGU6.004V.842</b>  | <b>MGU6.004V.542</b>  |
| terracotta     | <b>MGU6.004V.851</b>  | <b>MGU6.004V.551</b>  |
| glacier blue   | <b>MGU6.004V.854</b>  | <b>MGU6.004V.554</b>  |
| apple green    | <b>MGU6.004V.863</b>  | <b>MGU6.004V.563</b>  |
| mist grey      | <b>MGU6.004V.865</b>  | <b>MGU6.004V.565</b>  |
| pistachio      | <b>MGU6.004V.866</b>  | <b>MGU6.004V.566</b>  |
| sand           | <b>MGU6.004V.867</b>  | <b>MGU6.004V.567</b>  |
| orange         | <b>MGU6.004V.869</b>  | <b>MGU6.004V.569</b>  |
| water green    | <b>MGU6.004V.870</b>  | <b>MGU6.004V.570</b>  |
| cacao          | <b>MGU6.004V.871</b>  | <b>MGU6.004V.571</b>  |
| garnet         | <b>MGU6.004V.872</b>  | <b>MGU6.004V.572</b>  |
| manganese blue | <b>MGU6.004V.873</b>  | <b>MGU6.004V.573</b>  |
| mink           | <b>MGU6.004V.874</b>  | <b>MGU6.004V.574</b>  |
| mauve          | <b>MGU6.004V.876</b>  | <b>MGU6.004V.576</b>  |
| slate grey     | <b>MGU6.004V.877</b>  | <b>MGU6.004V.577</b>  |
| bright chrome  | <b>MGU66.004V.810</b> | <b>MGU66.004V.510</b> |
| gold           | <b>MGU66.004V.804</b> | <b>MGU66.004V.504</b> |

### 3 gang horizontal installation



| Colour         | white                | ivory                |
|----------------|----------------------|----------------------|
| white          | <b>MGU6.006.18</b>   |                      |
| ivory          |                      | <b>MGU6.006.25</b>   |
| champagne      | <b>MGU6.006.824</b>  | <b>MGU6.006.524</b>  |
| indigo blue    | <b>MGU6.006.842</b>  | <b>MGU6.006.542</b>  |
| terracotta     | <b>MGU6.006.851</b>  | <b>MGU6.006.551</b>  |
| glacier blue   | <b>MGU6.006.854</b>  | <b>MGU6.006.554</b>  |
| apple green    | <b>MGU6.006.863</b>  | <b>MGU6.006.563</b>  |
| mist grey      | <b>MGU6.006.865</b>  | <b>MGU6.006.565</b>  |
| pistachio      | <b>MGU6.006.866</b>  | <b>MGU6.006.566</b>  |
| sand           | <b>MGU6.006.867</b>  | <b>MGU6.006.567</b>  |
| orange         | <b>MGU6.006.869</b>  | <b>MGU6.006.569</b>  |
| water green    | <b>MGU6.006.870</b>  | <b>MGU6.006.570</b>  |
| cacao          | <b>MGU6.006.871</b>  | <b>MGU6.006.571</b>  |
| garnet         | <b>MGU6.006.872</b>  | <b>MGU6.006.572</b>  |
| manganese blue | <b>MGU6.006.873</b>  | <b>MGU6.006.573</b>  |
| mink           | <b>MGU6.006.874</b>  | <b>MGU6.006.574</b>  |
| mauve          | <b>MGU6.006.876</b>  | <b>MGU6.006.576</b>  |
| slate grey     | <b>MGU6.006.877</b>  | <b>MGU6.006.577</b>  |
| bright chrome  | <b>MGU66.006.810</b> | <b>MGU66.006.510</b> |
| gold           | <b>MGU66.006.804</b> | <b>MGU66.006.504</b> |



MGU6.006V.18

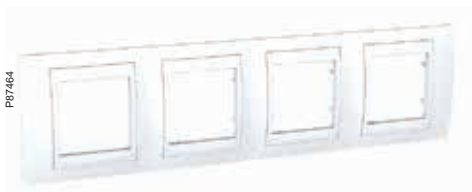

MGU6.008.18

white  
 ivory

- champagne
- indigo blue
- terracotta
- glacier blue
- apple green
- mist grey
- pistachio
- sand
- orange
- water green
- cacao
- garnet
- manganese blue
- mink
- mauve
- slate grey
- bright chrome
- gold

### 3 gang vertical installation



| Colour                                  | <input type="checkbox"/> white | <input type="checkbox"/> ivory |
|---|--------------------------------|--------------------------------|
| <input type="checkbox"/> white          | <b>MGU6.006V.18</b>            |                                |
| <input type="checkbox"/> ivory          |                                | <b>MGU6.006V.25</b>            |
| <input type="checkbox"/> champagne      | <b>MGU6.006V.824</b>           | <b>MGU6.006V.524</b>           |
| <input type="checkbox"/> indigo blue    |                                | <b>MGU6.006V.542</b>           |
| <input type="checkbox"/> terracotta     | <b>MGU6.006V.851</b>           | <b>MGU6.006V.551</b>           |
| <input type="checkbox"/> glacier blue   | <b>MGU6.006V.854</b>           |                                |
| <input type="checkbox"/> apple green    |                                | <b>MGU6.006V.563</b>           |
| <input type="checkbox"/> mist grey      | <b>MGU6.006V.865</b>           | <b>MGU6.006V.565</b>           |
| <input type="checkbox"/> pistachio      |                                | <b>MGU6.006V.566</b>           |
| <input type="checkbox"/> sand           | <b>MGU6.006V.867</b>           | <b>MGU6.006V.567</b>           |
| <input type="checkbox"/> orange         | <b>MGU6.006V.869</b>           | <b>MGU6.006V.569</b>           |
| <input type="checkbox"/> water green    | <b>MGU6.006V.870</b>           | <b>MGU6.006V.570</b>           |
| <input type="checkbox"/> cacao          | <b>MGU6.006V.871</b>           | <b>MGU6.006V.571</b>           |
| <input type="checkbox"/> garnet         | <b>MGU6.006V.872</b>           | <b>MGU6.006V.572</b>           |
| <input type="checkbox"/> manganese blue | <b>MGU6.006V.873</b>           | <b>MGU6.006V.573</b>           |
| <input type="checkbox"/> mink           | <b>MGU6.006V.874</b>           | <b>MGU6.006V.574</b>           |
| <input type="checkbox"/> mauve          | <b>MGU6.006V.876</b>           | <b>MGU6.006V.576</b>           |
| <input type="checkbox"/> slate grey     | <b>MGU6.006V.877</b>           | <b>MGU6.006V.577</b>           |
| <input type="checkbox"/> bright chrome  | <b>MGU66.006V.810</b>          | <b>MGU66.006V.510</b>          |
| <input type="checkbox"/> gold           | <b>MGU66.006V.804</b>          | <b>MGU66.006V.504</b>          |

### 4 gang horizontal installation



| Colour                                  | <input type="checkbox"/> white | <input type="checkbox"/> ivory |
|---|--------------------------------|--------------------------------|
| <input type="checkbox"/> white          | <b>MGU6.008.18</b>             |                                |
| <input type="checkbox"/> ivory          |                                | <b>MGU6.008.25</b>             |
| <input type="checkbox"/> champagne      | <b>MGU6.008.824</b>            | <b>MGU6.008.524</b>            |
| <input type="checkbox"/> indigo blue    | <b>MGU6.008.842</b>            | <b>MGU6.008.542</b>            |
| <input type="checkbox"/> terracotta     | <b>MGU6.008.851</b>            | <b>MGU6.008.551</b>            |
| <input type="checkbox"/> glacier blue   | <b>MGU6.008.854</b>            | <b>MGU6.008.554</b>            |
| <input type="checkbox"/> apple green    | <b>MGU6.008.863</b>            | <b>MGU6.008.563</b>            |
| <input type="checkbox"/> mist grey      | <b>MGU6.008.865</b>            | <b>MGU6.008.565</b>            |
| <input type="checkbox"/> pistachio      | <b>MGU6.008.866</b>            | <b>MGU6.008.566</b>            |
| <input type="checkbox"/> sand           | <b>MGU6.008.867</b>            | <b>MGU6.008.567</b>            |
| <input type="checkbox"/> orange         | <b>MGU6.008.869</b>            | <b>MGU6.008.569</b>            |
| <input type="checkbox"/> water green    | <b>MGU6.008.870</b>            | <b>MGU6.008.570</b>            |
| <input type="checkbox"/> cacao          | <b>MGU6.008.871</b>            | <b>MGU6.008.571</b>            |
| <input type="checkbox"/> garnet         | <b>MGU6.008.872</b>            | <b>MGU6.008.572</b>            |
| <input type="checkbox"/> manganese blue | <b>MGU6.008.873</b>            | <b>MGU6.008.573</b>            |
| <input type="checkbox"/> mink           | <b>MGU6.008.874</b>            | <b>MGU6.008.574</b>            |
| <input type="checkbox"/> mauve          | <b>MGU6.008.876</b>            | <b>MGU6.008.576</b>            |
| <input type="checkbox"/> slate grey     | <b>MGU6.008.877</b>            | <b>MGU6.008.577</b>            |
| <input type="checkbox"/> bright chrome  | <b>MGU66.008.810</b>           | <b>MGU66.008.510</b>           |
| <input type="checkbox"/> gold           | <b>MGU66.008.804</b>           | <b>MGU66.008.504</b>           |



MGU6.014V.18



MGU6.016V.18

### 2 gang 57 mm interaxis vertical installation

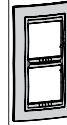

| Colour                              | <input type="checkbox"/> white | <input type="checkbox"/> ivory |
|-------------------------------------|--------------------------------|--------------------------------|
| <input type="checkbox"/> white      | <b>MGU6.014V.18</b>            |                                |
| <input type="checkbox"/> ivory      |                                | <b>MGU6.014V.25</b>            |
| <input type="checkbox"/> champagne  | <b>MGU6.014V.824</b>           |                                |
| <input type="checkbox"/> terracotta |                                | <b>MGU6.014V.551</b>           |
| <input type="checkbox"/> sand       | <b>MGU6.014V.867</b>           | <b>MGU6.014V.567</b>           |
| <input type="checkbox"/> cacao      | <b>MGU6.014V.871</b>           |                                |
| <input type="checkbox"/> mink       | <b>MGU6.014V.874</b>           | <b>MGU6.014V.574</b>           |
| <input type="checkbox"/> slate grey | <b>MGU6.014V.877</b>           |                                |

### 3 gang 57 mm interaxis vertical installation

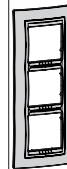

| Colour                              | <input type="checkbox"/> white | <input type="checkbox"/> ivory |
|-------------------------------------|--------------------------------|--------------------------------|
| <input type="checkbox"/> white      | <b>MGU6.016V.18</b>            |                                |
| <input type="checkbox"/> ivory      |                                | <b>MGU6.016V.25</b>            |
| <input type="checkbox"/> champagne  | <b>MGU6.016V.824</b>           |                                |
| <input type="checkbox"/> terracotta |                                | <b>MGU6.016V.551</b>           |
| <input type="checkbox"/> mist grey  | <b>MGU6.016V.865</b>           |                                |
| <input type="checkbox"/> sand       | <b>MGU6.016V.867</b>           | <b>MGU6.016V.567</b>           |
| <input type="checkbox"/> cacao      | <b>MGU6.016V.871</b>           |                                |
| <input type="checkbox"/> mink       | <b>MGU6.016V.874</b>           |                                |
| <input type="checkbox"/> slate grey | <b>MGU6.016V.877</b>           | <b>MGU6.016V.577</b>           |



### 3 modules Italian cover frames



| Colour         | white         | ivory        |
|----------------|---------------|--------------|
| champagne      | MGU6.103.824  | MGU6.103.524 |
| indigo blue    | MGU6.103.842  | MGU6.103.542 |
| terracotta     | MGU6.103.851  | MGU6.103.551 |
| glacier blue   | MGU6.103.854  | MGU6.103.554 |
| apple green    | MGU6.103.863  | MGU6.103.563 |
| mist grey      |               | MGU6.103.565 |
| pistachio      | MGU6.103.866  | MGU6.103.566 |
| sand           | MGU6.103.867  | MGU6.103.567 |
| orange         | MGU6.103.869  | MGU6.103.569 |
| water green    | MGU6.103.870  | MGU6.103.570 |
| cacao          | MGU6.103.871  | MGU6.103.571 |
| garnet         | MGU6.103.872  | MGU6.103.572 |
| manganese blue | MGU6.103.873  | MGU6.103.573 |
| mink           | MGU6.103.874  | MGU6.103.574 |
| mauve          | MGU6.103.876  | MGU6.103.576 |
| slate grey     | MGU6.103.877  | MGU6.103.577 |
| bright chrome  | MGU66.103.810 |              |
| gold           | MGU66.103.804 |              |

### 4 modules Italian cover frames



| Colour         | white        | ivory        |
|----------------|--------------|--------------|
| champagne      | MGU6.104.824 | MGU6.104.524 |
| indigo blue    | MGU6.104.842 | MGU6.104.542 |
| terracotta     | MGU6.104.851 | MGU6.104.551 |
| glacier blue   | MGU6.104.854 |              |
| apple green    | MGU6.104.863 | MGU6.104.563 |
| mist grey      | MGU6.104.865 | MGU6.104.565 |
| pistachio      | MGU6.104.866 | MGU6.104.566 |
| sand           | MGU6.104.867 | MGU6.104.567 |
| orange         | MGU6.104.869 | MGU6.104.569 |
| cacao          | MGU6.104.871 | MGU6.104.571 |
| garnet         | MGU6.104.872 | MGU6.104.572 |
| manganese blue | MGU6.104.873 | MGU6.104.573 |
| mink           | MGU6.104.874 | MGU6.104.574 |
| mauve          | MGU6.104.876 | MGU6.104.576 |
| slate grey     | MGU6.104.877 | MGU6.104.577 |

### 6 modules Italian cover frames



| Colour       | white        | ivory        |
|--------------|--------------|--------------|
| champagne    | MGU6.106.824 | MGU6.106.524 |
| indigo blue  | MGU6.106.842 | MGU6.106.542 |
| terracotta   | MGU6.106.851 | MGU6.106.551 |
| glacier blue | MGU6.106.854 | MGU6.106.554 |
| apple green  | MGU6.106.863 | MGU6.106.563 |
| mist grey    | MGU6.106.865 | MGU6.106.565 |
| pistachio    | MGU6.106.866 | MGU6.106.566 |
| sand         | MGU6.106.867 | MGU6.106.567 |
| orange       | MGU6.106.869 | MGU6.106.569 |
| water green  | MGU6.106.870 |              |
| cacao        | MGU6.106.871 | MGU6.106.571 |
| garnet       | MGU6.106.872 | MGU6.106.572 |
| mink         | MGU6.106.874 | MGU6.106.574 |
| mauve        | MGU6.106.876 | MGU6.106.576 |
| slate grey   | MGU6.106.877 |              |





P87471

MGU248.424.18



P87472

MGU48.426.18

## Centralization cover frames

### 2 x 4 modules



| Colour         | white                | ivory                |
|----------------|----------------------|----------------------|
| white          | <b>MGU48.424.18</b>  |                      |
| ivory          |                      | <b>MGU48.424.25</b>  |
| champagne      | <b>MGU48.424.824</b> | <b>MGU48.424.524</b> |
| indigo blue    | <b>MGU48.424.842</b> |                      |
| terracotta     | <b>MGU48.424.851</b> |                      |
| glacier blue   | <b>MGU48.424.854</b> |                      |
| apple green    | <b>MGU48.424.863</b> |                      |
| mist grey      | <b>MGU48.424.865</b> |                      |
| pistachio      | <b>MGU48.424.866</b> |                      |
| sand           | <b>MGU48.424.867</b> | <b>MGU48.424.567</b> |
| orange         | <b>MGU48.424.869</b> |                      |
| cacao          | <b>MGU48.424.871</b> | <b>MGU48.424.571</b> |
| garnet         | <b>MGU48.424.872</b> |                      |
| manganese blue | <b>MGU48.424.873</b> |                      |
| mink           | <b>MGU48.424.874</b> | <b>MGU48.424.574</b> |
| mauve          |                      | <b>MGU48.424.576</b> |
| slate grey     | <b>MGU48.424.877</b> |                      |
| bright chrome  | <b>MGU49.424.810</b> | <b>MGU49.424.510</b> |
| gold           | <b>MGU49.424.804</b> | <b>MGU49.424.504</b> |

### 2 x 6 modules



| Colour        | white                | ivory                |
|---------------|----------------------|----------------------|
| white         | <b>MGU48.426.18</b>  |                      |
| ivory         |                      | <b>MGU48.426.25</b>  |
| champagne     | <b>MGU48.426.824</b> | <b>MGU48.426.524</b> |
| terracotta    | <b>MGU48.426.851</b> |                      |
| mist grey     | <b>MGU48.426.865</b> |                      |
| sand          | <b>MGU48.426.867</b> | <b>MGU48.426.567</b> |
| cacao         | <b>MGU48.426.871</b> |                      |
| garnet        | <b>MGU48.426.872</b> |                      |
| mink          | <b>MGU48.426.874</b> | <b>MGU48.426.574</b> |
| slate grey    | <b>MGU48.426.877</b> |                      |
| bright chrome | <b>MGU49.426.810</b> | <b>MGU49.426.510</b> |
| gold          | <b>MGU49.426.804</b> | <b>MGU49.426.504</b> |



MGU6.502.18

MGU6.504.18





MGU6.506.18





MGU61.002.18G

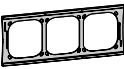

## Supplementary frames

|         | 1 gang   | 2 gang  |
|---------|--|---|
|         |   |  |
| Colour  |  |   |
| □ white | <b>MGU6.502.18</b>   | <b>MGU6.504.18</b>  |
| ■ ivory | <b>MGU6.502.25</b>   |   |
|         | 3 gang   |   |
|         |  |   |
| Colour  |  |   |
| ■ ivory | <b>MGU6.506.25</b>   |   |

## Cover and fixing frame IP44

|                  | Without claws   | With claws  |
|------------------|---|---|
|                  |  |  |
| Colour           |   |   |
| □ white          | <b>MGU61.002.18</b>   | <b>MGU61.002.18G</b>  |
| ■ ivory          | <b>MGU61.002.25</b>   | <b>MGU61.002.25G</b>  |
| ■ champagne      | <b>MGU61.002.824</b>  |   |
| ■ indigo blue    | <b>MGU61.002.842</b>  |   |
| ■ terracotta     | <b>MGU61.002.851</b>  |   |
| ■ glacier blue   | <b>MGU61.002.854</b>  |   |
| ■ apple green    | <b>MGU61.002.863</b>  |   |
| ■ mist grey      | <b>MGU61.002.865</b>  |   |
| ■ pistachio      | <b>MGU61.002.866</b>  |   |
| ■ sand           | <b>MGU61.002.867</b>  |   |
| ■ orange         | <b>MGU61.002.869</b>  |   |
| ■ water green    | <b>MGU61.002.870</b>  |   |
| ■ cacao          | <b>MGU61.002.871</b>  |   |
| ■ garnet         | <b>MGU61.002.872</b>  |   |
| ■ manganese blue | <b>MGU61.002.873</b>  |   |
| ■ mink           | <b>MGU61.002.874</b>  |   |
| ■ mauve          | <b>MGU61.002.876</b>  |   |
| ■ slate grey     | <b>MGU61.002.877</b>  |   |
| ■ bright chrome  | <b>MGU61.002.810</b>  |   |
| ■ gold           | <b>MGU61.002.804</b>  |   |

## Cover and fixing frame IP55

|         | IP55   |   |
|---------|--|---|
|         |  |  |
| Colour  | 3 modules  | 4 modules   |
| □ white | <b>MGU11.103.18</b>  | <b>MGU11.104.18</b>   |
| ■ ivory | <b>MGU11.103.25</b>  | <b>MGU11.104.25</b>   |



# Unica Quadro



# Unica Quadro aesthetics

## Metallized colours



## Natura colours

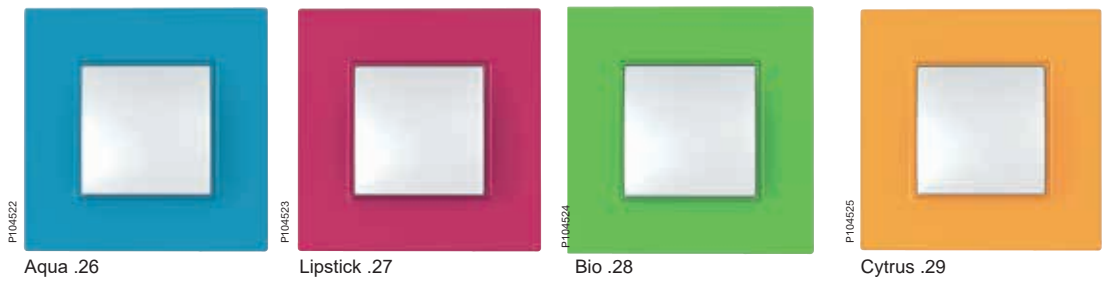



P104903

Pearl colours



P104526

Salmon .37

P104527

Pearl .35

P104528

Candy .36

Quadro colours



P104520

White .18

P104521

Ivory .25

P104518

Stone .16

P104519

Urban green .17



MGU2.702.18





MGU2.704.18





MGU42.706.18

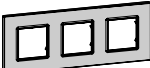

MGU2.708.18

|                          | 1 gang  | 2 gang  |
|--------------------------|---|---|
|                          |  |  |
| <b>Quadro</b>            |   |   |
| □ white                  | MGU2.702.18   | MGU2.704.18   |
| □ ivory                  | MGU2.702.25   | MGU2.704.25   |
| □ stone                  | MGU2.702.16   | MGU2.704.16   |
| □ Urban green            | MGU2.702.17   | MGU2.704.17   |
| <b>Quadro Natura</b>     |   |   |
| ■ aqua                   | MGU4.702.26   | MGU4.704.26   |
| ■ lipstick               | MGU4.702.27   | MGU4.704.27   |
| ■ bio                    | MGU4.702.28   | MGU4.704.28   |
| ■ citrus                 | MGU4.702.29   | MGU4.704.29   |
| <b>Quadro Pearl</b>      |   |   |
| ■ salmon                 | MGU4.702.37   | MGU4.704.37   |
| ■ pearl                  | MGU4.702.35   | MGU4.704.35   |
| ■ candy                  | MGU4.702.36   | MGU4.704.36   |
| <b>Quadro Metallized</b> |   |   |
| ■ silver                 | MGU6.702.55   | MGU6.704.55   |
| ■ copper                 | MGU6.702.56   | MGU6.704.56   |
| ■ titanium               | MGU6.702.57   | MGU6.704.57   |

|                          | 3 gang  | 4 gang   |
|--------------------------|---|--|
|                          |  |  |
| <b>Quadro</b>            |   |  |
| □ white                  | MGU2.706.18   | MGU2.708.18  |
| □ ivory                  | MGU2.706.25   | MGU2.708.25  |
| □ stone                  | MGU2.706.16   | MGU2.708.16  |
| □ Urban green            | MGU2.706.17   | MGU2.708.17  |
| <b>Quadro Natura</b>     |   |  |
| ■ aqua                   | MGU4.706.26   | MGU4.708.26  |
| ■ lipstick               | MGU4.706.27   | MGU4.708.27  |
| ■ bio                    | MGU4.706.28   | MGU4.708.28  |
| ■ citrus                 | MGU4.706.29   | MGU4.708.29  |
| <b>Quadro Pearl</b>      |   |  |
| ■ salmon                 | MGU4.706.37   | MGU4.708.37  |
| ■ pearl                  | MGU4.706.35   | MGU4.708.35  |
| ■ candy                  | MGU4.706.36   | MGU4.708.36  |
| <b>Quadro Metallized</b> |   |  |
| ■ silver                 | MGU6.706.55   | MGU6.708.55  |
| ■ copper                 | MGU6.706.56   | MGU6.708.56  |
| ■ titanium               | MGU6.706.57   | MGU6.708.57  |



# Unica Quadro Cover frames



MGU2.801.18



MGU2.802.18



MGU2.803.18



MGU2.804.18



MGU2.806.18

|                                   | 1 module         | 2 modules   |
|-----------------------------------|------------------|-------------|
|                                   |                  |             |
| <b>Quadro</b>                     |                  |             |
| <input type="checkbox"/> white    | MGU2.801.18      | MGU2.802.18 |
| <input type="checkbox"/> ivory    | MGU2.801.25      | MGU2.802.25 |
| <b>Quadro Metallized</b>          |                  |             |
| <input type="checkbox"/> silver   | MGU2.801.55      | MGU2.802.55 |
| <input type="checkbox"/> titanium | MGU2.801.57      | MGU2.802.57 |
|                                   |                  |             |
|                                   | <b>3 modules</b> |             |
|                                   |                  |             |
| <b>Quadro</b>                     |                  |             |
| <input type="checkbox"/> white    | MGU2.803.18      | MGU2.804.18 |
| <input type="checkbox"/> ivory    | MGU2.803.25      | MGU2.804.25 |
| <b>Quadro Metallized</b>          |                  |             |
| <input type="checkbox"/> silver   | MGU2.803.55      | MGU2.804.55 |
| <input type="checkbox"/> titanium | MGU2.803.57      | MGU2.804.57 |
|                                   |                  |             |
|                                   | <b>6 modules</b> |             |
|                                   |                  |             |
| <b>Quadro</b>                     |                  |             |
| <input type="checkbox"/> white    | MGU2.806.18      |             |
| <input type="checkbox"/> ivory    | MGU2.806.25      |             |
| <b>Quadro Metallized</b>          |                  |             |
| <input type="checkbox"/> silver   | MGU2.806.55      |             |
| <input type="checkbox"/> titanium | MGU2.806.57      |             |

# Unica Allegro



# Unica Allegro aesthetics

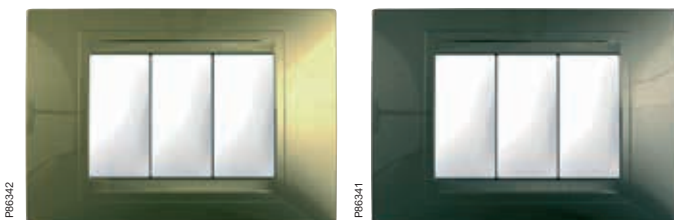



P104904



P86340

Champagne .24



P86336

Aluminium .30



P86339

Dull silver .60



P86332

Technical grey .58



P86334

Graphite grey .62



P86335

Indigo blue .42



P86337

Glacier blue .54



MGU4.101.18



MGU4.102.18



MGU4.103.18

## 1 module



| Colour                                  |                    |
|---|--------------------|
| <input type="checkbox"/> white          | <b>MGU4.101.18</b> |
| <input type="checkbox"/> ivory          | <b>MGU4.101.25</b> |
| <input type="checkbox"/> bronze         | <b>MGU4.101.13</b> |
| <input type="checkbox"/> champagne      | <b>MGU4.101.24</b> |
| <input type="checkbox"/> aluminium      | <b>MGU4.101.30</b> |
| <input type="checkbox"/> indigo blue    | <b>MGU4.101.42</b> |
| <input type="checkbox"/> terracotta     | <b>MGU4.101.51</b> |
| <input type="checkbox"/> glacier blue   | <b>MGU4.101.54</b> |
| <input type="checkbox"/> technical grey | <b>MGU4.101.58</b> |
| <input type="checkbox"/> cream          | <b>MGU4.101.59</b> |
| <input type="checkbox"/> dull silver    | <b>MGU4.101.60</b> |
| <input type="checkbox"/> graphite grey  | <b>MGU4.101.62</b> |
| <input type="checkbox"/> golden         | <b>MGU4.101.64</b> |
| <input type="checkbox"/> sand           | <b>MGU4.101.67</b> |

## 2 modules



| Colour                                  |                    |
|---|--------------------|
| <input type="checkbox"/> white          | <b>MGU4.102.18</b> |
| <input type="checkbox"/> ivory          | <b>MGU4.102.25</b> |
| <input type="checkbox"/> bronze         | <b>MGU4.102.13</b> |
| <input type="checkbox"/> champagne      | <b>MGU4.102.24</b> |
| <input type="checkbox"/> aluminium      | <b>MGU4.102.30</b> |
| <input type="checkbox"/> indigo blue    | <b>MGU4.102.42</b> |
| <input type="checkbox"/> terracotta     | <b>MGU4.102.51</b> |
| <input type="checkbox"/> glacier blue   | <b>MGU4.102.54</b> |
| <input type="checkbox"/> technical grey | <b>MGU4.102.58</b> |
| <input type="checkbox"/> cream          | <b>MGU4.102.59</b> |
| <input type="checkbox"/> dull silver    | <b>MGU4.102.60</b> |
| <input type="checkbox"/> graphite grey  | <b>MGU4.102.62</b> |
| <input type="checkbox"/> golden         | <b>MGU4.102.64</b> |
| <input type="checkbox"/> sand           | <b>MGU4.102.67</b> |

## 3 modules



| Colour                                  |                    |
|---|--------------------|
| <input type="checkbox"/> white          | <b>MGU4.103.18</b> |
| <input type="checkbox"/> ivory          | <b>MGU4.103.25</b> |
| <input type="checkbox"/> bronze         | <b>MGU4.103.13</b> |
| <input type="checkbox"/> champagne      | <b>MGU4.103.24</b> |
| <input type="checkbox"/> aluminium      | <b>MGU4.103.30</b> |
| <input type="checkbox"/> indigo blue    | <b>MGU4.103.42</b> |
| <input type="checkbox"/> terracotta     | <b>MGU4.103.51</b> |
| <input type="checkbox"/> glacier blue   | <b>MGU4.103.54</b> |
| <input type="checkbox"/> technical grey | <b>MGU4.103.58</b> |
| <input type="checkbox"/> cream          | <b>MGU4.103.59</b> |
| <input type="checkbox"/> dull silver    | <b>MGU4.103.60</b> |
| <input type="checkbox"/> graphite grey  | <b>MGU4.103.62</b> |
| <input type="checkbox"/> golden         | <b>MGU4.103.64</b> |
| <input type="checkbox"/> sand           | <b>MGU4.103.67</b> |



MGU4.104.18



MGU4.106.18

## 4 modules



| Colour                                  |             |
|---|-------------|
| <input type="checkbox"/> white          | MGU4.104.18 |
| <input type="checkbox"/> ivory          | MGU4.104.25 |
| <input type="checkbox"/> bronze         | MGU4.104.13 |
| <input type="checkbox"/> champagne      | MGU4.104.24 |
| <input type="checkbox"/> aluminium      | MGU4.104.30 |
| <input type="checkbox"/> indigo blue    | MGU4.104.42 |
| <input type="checkbox"/> terracotta     | MGU4.104.51 |
| <input type="checkbox"/> glacier blue   | MGU4.104.54 |
| <input type="checkbox"/> technical grey | MGU4.104.58 |
| <input type="checkbox"/> cream          | MGU4.104.59 |
| <input type="checkbox"/> dull silver    | MGU4.104.60 |
| <input type="checkbox"/> graphite grey  | MGU4.104.62 |
| <input type="checkbox"/> golden         | MGU4.104.64 |
| <input type="checkbox"/> sand           | MGU4.104.67 |

## 6 modules



| Colour                                  |             |
|---|-------------|
| <input type="checkbox"/> white          | MGU4.106.18 |
| <input type="checkbox"/> ivory          | MGU4.106.25 |
| <input type="checkbox"/> technical grey | MGU4.106.58 |
| <input type="checkbox"/> aluminium      | MGU4.106.30 |
| <input type="checkbox"/> cream          | MGU4.106.59 |
| <input type="checkbox"/> graphite grey  | MGU4.106.62 |
| <input type="checkbox"/> indigo blue    | MGU4.106.42 |
| <input type="checkbox"/> glacier blue   | MGU4.106.54 |
| <input type="checkbox"/> terracotta     | MGU4.106.51 |
| <input type="checkbox"/> dull silver    | MGU4.106.60 |
| <input type="checkbox"/> champagne      | MGU4.106.24 |
| <input type="checkbox"/> bronze         | MGU4.106.13 |
| <input type="checkbox"/> golden         | MGU4.106.64 |
| <input type="checkbox"/> sand           | MGU4.106.67 |

# Unica Colors





# Unica Colors aesthetics

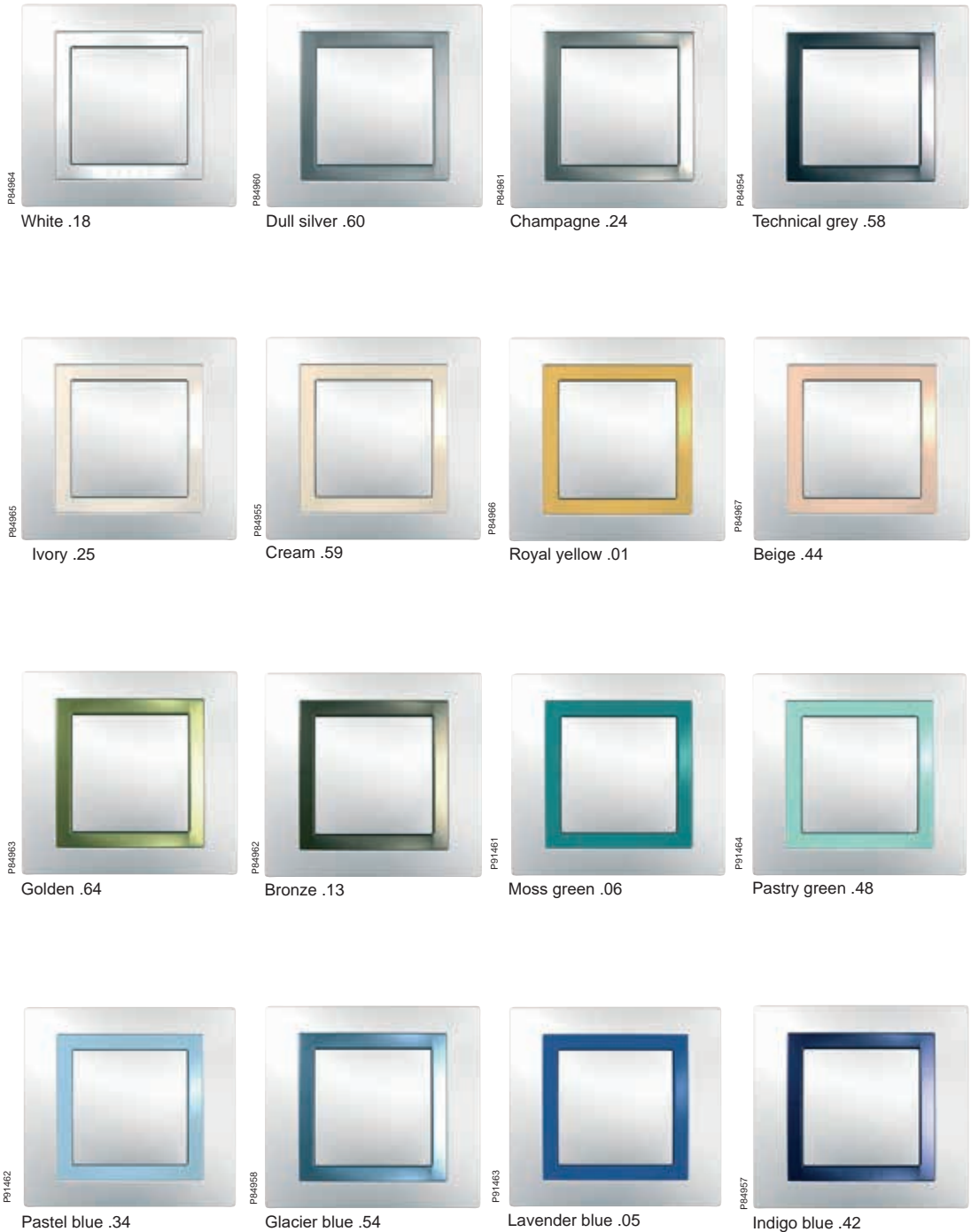



P104902



P84956

Graphite grey .62

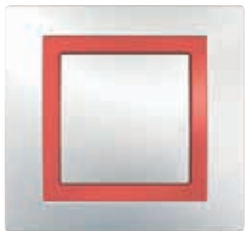

P91459

Red .43



P84959

Terracotta .51



P91460

Violet .31



MGU4.002.18



MGU4.004.18



MGU4.006.18

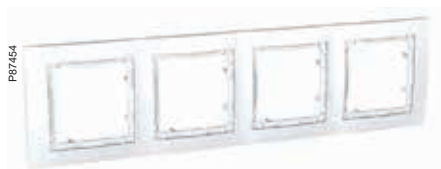

MGU4.008.18



MGU4.010.18



MGU22.302.18

## 1 gang



|                                |             |
|--------------------------------|-------------|
| Colour                         |             |
| <input type="checkbox"/> white | MGU4.002.18 |
| <input type="checkbox"/> ivory | MGU4.002.25 |

## 2 gang

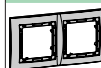

|                                |             |
|--------------------------------|-------------|
| Colour                         |             |
| <input type="checkbox"/> white | MGU4.004.18 |
| <input type="checkbox"/> ivory | MGU4.004.25 |

## 3 gang



|                                |             |
|--------------------------------|-------------|
| Colour                         |             |
| <input type="checkbox"/> white | MGU4.006.18 |
| <input type="checkbox"/> ivory | MGU4.006.25 |

## 4 gang



|                                |             |
|--------------------------------|-------------|
| Colour                         |             |
| <input type="checkbox"/> white | MGU4.008.18 |
| <input type="checkbox"/> ivory | MGU4.008.25 |

## 5 gang

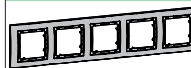

|                                |             |
|--------------------------------|-------------|
| Colour                         |             |
| <input type="checkbox"/> white | MGU4.010.18 |
| <input type="checkbox"/> ivory | MGU4.010.25 |

## Cover frames and boxes

### 1 gang complete assembly



|                                |              |              |
|--------------------------------|--------------|--------------|
| Colour                         |              |              |
| <input type="checkbox"/> white | MGU22.302.18 | MGU22.304.18 |
| <input type="checkbox"/> ivory | MGU22.302.25 | MGU22.304.25 |

Cover and fixing frame + box



MGU4.000.18



MGU2.502.18

P87482

P87491

## Decorative frames



| Colour                                  |             |
|---|-------------|
| <input type="checkbox"/> white          | MGU4.000.18 |
| <input type="checkbox"/> ivory          | MGU4.000.25 |
| <input type="checkbox"/> royal yellow   | MGU4.000.01 |
| <input type="checkbox"/> lavender blue  | MGU4.000.05 |
| <input type="checkbox"/> moss green     | MGU4.000.06 |
| <input type="checkbox"/> bronze         | MGU4.000.13 |
| <input type="checkbox"/> champagne      | MGU4.000.24 |
| <input type="checkbox"/> violet         | MGU4.000.31 |
| <input type="checkbox"/> pastel blue    | MGU4.000.34 |
| <input type="checkbox"/> indigo blue    | MGU4.000.42 |
| <input type="checkbox"/> red            | MGU4.000.43 |
| <input type="checkbox"/> beige          | MGU4.000.44 |
| <input type="checkbox"/> pastry green   | MGU4.000.48 |
| <input type="checkbox"/> terracotta     | MGU4.000.51 |
| <input type="checkbox"/> glacier blue   | MGU4.000.54 |
| <input type="checkbox"/> technical grey | MGU4.000.58 |
| <input type="checkbox"/> cream          | MGU4.000.59 |
| <input type="checkbox"/> dull silver    | MGU4.000.60 |
| <input type="checkbox"/> graphite grey  | MGU4.000.62 |
| <input type="checkbox"/> golden         | MGU4.000.64 |

## Supplementary frames

### 1 gang



| Colour                         |             |
|--------------------------------|-------------|
| <input type="checkbox"/> white | MGU2.502.18 |

# Unica Basic



P105764



P84951

Ivory .25



P84953

Cream / ivory .559



P86055

Cream / white .859



P84950

White .18



P84952

Technical grey / white .858

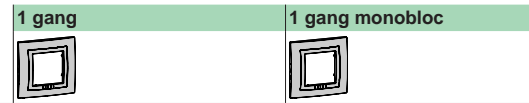

| Colour  | 1 gang       | 1 gang monobloc |
|---|--------------|-----------------|
| <input type="checkbox"/> white                | MGU2.002.18  | MGU2.002.18M    |
| <input type="checkbox"/> ivory                | MGU2.002.25  | MGU2.002.25M    |
| <input type="checkbox"/> technical grey/white | MGU2.002.858 |                 |
| <input type="checkbox"/> cream/ivory          | MGU2.002.559 |                 |
| <input type="checkbox"/> cream/white          | MGU2.002.859 |                 |



| Colour  | 2 gang       |
|---|--------------|
| <input type="checkbox"/> white                | MGU2.004.18  |
| <input type="checkbox"/> ivory                | MGU2.004.25  |
| <input type="checkbox"/> technical grey/white | MGU2.004.858 |
| <input type="checkbox"/> cream/ivory          | MGU2.004.559 |
| <input type="checkbox"/> cream/white          | MGU2.004.859 |



| Colour  | 3 gang       |
|---|--------------|
| <input type="checkbox"/> white                | MGU2.006.18  |
| <input type="checkbox"/> ivory                | MGU2.006.25  |
| <input type="checkbox"/> technical grey/white | MGU2.006.858 |
| <input type="checkbox"/> cream/ivory          | MGU2.006.559 |
| <input type="checkbox"/> cream/white          | MGU2.006.859 |



| Colour  | 4 gang       |
|---|--------------|
| <input type="checkbox"/> white                | MGU2.008.18  |
| <input type="checkbox"/> ivory                | MGU2.008.25  |
| <input type="checkbox"/> technical grey/white | MGU2.008.858 |
| <input type="checkbox"/> cream/ivory          | MGU2.008.559 |
| <input type="checkbox"/> cream/white          | MGU2.008.859 |



| Colour                         | 5 gang      |
|--------------------------------|-------------|
| <input type="checkbox"/> white | MGU2.010.18 |
| <input type="checkbox"/> ivory | MGU2.010.25 |

## Cover and fixing frames for thin panels

### Cover and fixing frames for thin panels

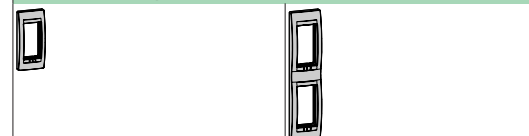

| Colour                         | 1 module      | 1 + 1 modules |
|--------------------------------|---------------|---------------|
| <input type="checkbox"/> white | MGU47.201.18P | MGU47.202.18P |
| <input type="checkbox"/> ivory | MGU47.201.25P | MGU47.202.25P |





# Unica Basic Cover frames



MGU22.302.18

P.87465

## Cover frames and boxes

|                                | 1 gang complete assembly   | 2 gang complete assembly  |
|--------------------------------|--|---|
|                                |  |  |
| Colour                         |  |   |
| <input type="checkbox"/> white | <b>MGU22.302.18</b>  | <b>MGU22.304.18</b>   |
| <input type="checkbox"/> ivory | <b>MGU22.302.25</b>  | <b>MGU22.304.25</b>   |
|                                | Cover and fixing frame + box   |   |



|                                   | page |
|-----------------------------------|------|
| Switches and push-buttons         | 156  |
| MCB and RCD switches              | 160  |
| Fuse holders                      | 161  |
| Rotary electronic dimmer switches | 162  |
| Push-button dimmer switches       | 166  |
| Movement and presence detectors   | 167  |
| Thermostats                       | 171  |
| Weekly-programmable thermostats   | 173  |
| Time-delay switches               | 175  |
| Weekly programmable timers        | 176  |
| Weatherstations                   | 177  |
| Wake up clocks                    | 178  |
| Key card switches                 | 179  |
| Technical alarms                  | 181  |
| Socket-outlets                    | 182  |
| RJ45 data sockets                 | 183  |
| TV/FM/SAT sockets                 | 192  |
| USB chargers                      | 194  |
| In-wall bluetooth audio receivers | 195  |
| Telephone sockets                 | 197  |
| Indicator lamps                   | 198  |
| Buzzers                           | 199  |
| Electronic bells                  | 200  |
| Emergency lights                  | 201  |
| Autonomous pilotlamps             | 202  |
| Fixing frames                     | 203  |
| Surface-mounted boxes             | 205  |
| IP55 surface-mounted boxes        | 206  |
| Flush mounting boxes              | 207  |
| Cover frames                      | 208  |

## Area of application

### Switches and selector switches

- Control (On/Off) of circuits with resistive loads, inductive loads and small motors (lighting with incandescent and fluorescent lamps and transformers, fans, vacuum cleaners, power socket control, etc.).
- Control devices with a locator or indicator lamp include a LED lamp connected inside. These devices are available in 2 versions:
  - items with a blue locator lamp, for night-time identification in reduced light conditions or complete darkness, for example corridors, stairways, etc. (ref. finishes in N). In this case, the lamp indicates that the load is connected but on standby: when the load is in operation, the lamp is off
  - items with an amber indicator lamp for indication of load in operation (ref. finishes in S). The lamp indicates that the load is in operation

### Push-buttons

- Control of bells and sound in general.
- Auxiliary control of regulators, time delay relays and presence detection control switches.
- Control of impulse relays.
- Usable as controls for and other pulse-type systems.
- Push-buttons with a blue locator lamp, for night-time identification in reduced light conditions or complete darkness, for example corridors, stairways, etc. (ref. finishes in N). In this case, the lamp indicates that the load is connected but on standby: when the load is in operation, the lamp is off.

### Mechanisms for roller blinds

- Rated current and voltage: 10 A- 250 V AC (2.5 A motor control).
- Used to control motorized shutters, roller blinds, etc.
- These devices are available in 2 ranges:
  - switch: for direct start-up of motors without automation system (with limit stop)
  - push-button: for motor control by automation systems or with limit stop and for roller blinds equipped with an electronic control system.
- The mechanisms for roller blinds include a safety locking system and/or moving to zero on the wiring diagram, thus preventing simultaneous control in both directions.

## Common technical data

- Rated current and voltage: 10 AX 250 V AC; 16 AX 250 V AC, 20 AX and 32 A (25 AX) (also suitable for fluorescent loads).
- Materials: self-extinguishing technopolymer with excellent impact strength and halogen-free.
- All the devices and covers are resistant to cleaning products and UV radiation.
- The locator or indicator lamps are LED, already installed in the device (does not need to be connected separately) and exhibiting the following characteristics:
  - maximum current: 0.15 mA,
  - lifetime: 80 000 h,
  - maximum temperature rise: 7 °C.

## Dimensions (mm)

### Screwless terminals control devices (10 A devices)

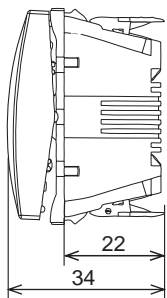

### Screw terminals control devices (10 A and 16 A devices)

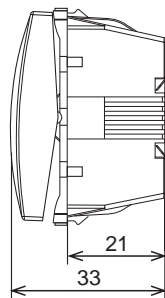

## Standards

- In accordance with EN 60.669-1 and to LV and EMC directives.
- Contact opening distance: > 3 mm.
- Insulation resistance: > 5 MΩ / 500 V.
- Dielectric strength: > 2000 V.
- Minimum breaking capacity:
  - 200 operations at 1.25 x In and 1.1 x Vn, where Pf (cosφ) = 0.3
  - 200 operations at 1.25 x In and Vn with tungsten filament lamps (not applicable to push-buttons).
- Minimum useful life:
  - 40,000 position changes at In and 250 V, where Pf (cosφ) = 0.6 (10 A and 16 A devices)
  - 10,000 position changes at In and 250 V where Pf (cosφ) = 0.6 (20 A and 32 A devices)
  - 10,000 position changes with fluorescent load (10 AX devices)
  - 5,000 position changes with fluorescent load (16 AX devices).
- Printing on push-buttons: indelible pad printing as per EN 60.669-1.
- Rated current for double switches is considered in the common phase (the sum of currents in both circuits) according to EN 60.669-1.
- Mechanisms for roller blinds according to EN 60.669-1 (for switches) and EN 61.058-1 (for devices) As per EN 60.669-1.

## Installation

- These devices can be easily assembled and disassembled by the front panel by clipping On and Off. During assembly, a «clicking» noise informs you that the device has been placed correctly in the rack.
- Push-buttons can be customized on request using drawings produced by pad printing.

## Connections

- Connection terminals:
  - for 10 A devices; screw or screwless terminals for rigid or flexible cables up to 2.5 mm<sup>2</sup>
  - for 16 A devices; screw terminals for rigid or flexible cables up to 4 mm<sup>2</sup>
  - for 32 A devices; screw terminals for rigid or flexible cables up to 6 mm<sup>2</sup>.
- Colour code for quick identification of terminals in the screwless connection versions.

## Blue locator or amber indicator lamps

### Lamps replacement

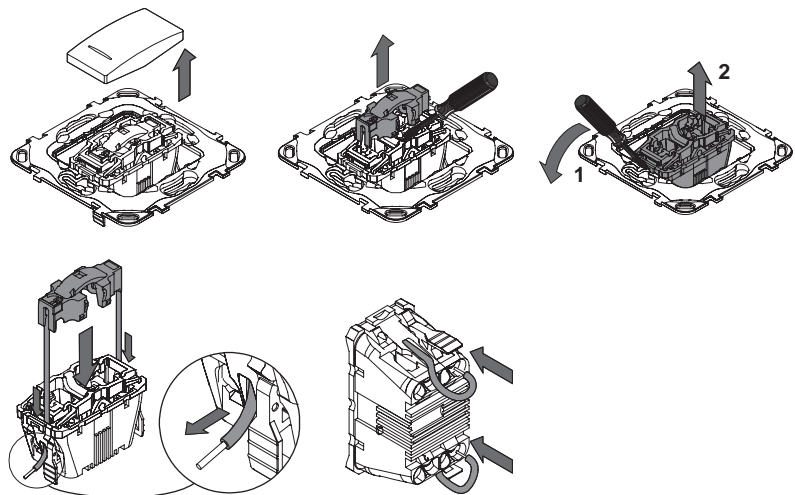

## Switches and push-buttons

### Connection examples

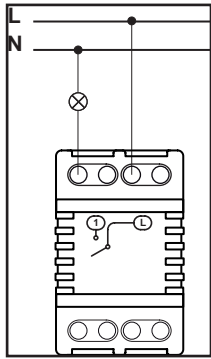

One-way switch

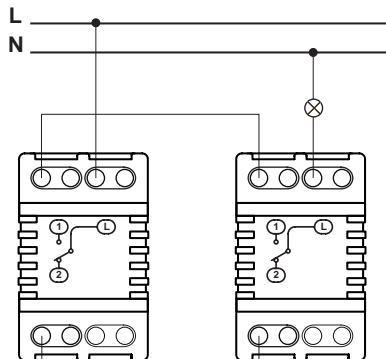

2 two-way switches

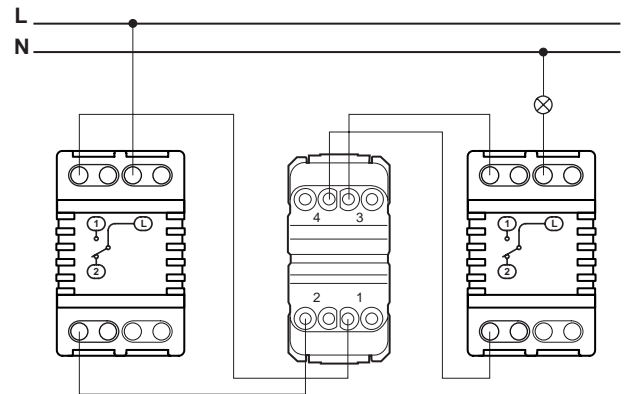

2 two-way switches + 1 intermediate switch

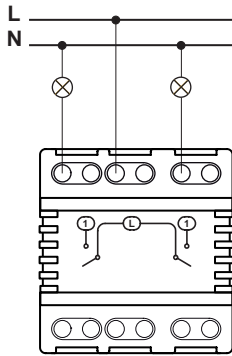

Double one-way switch

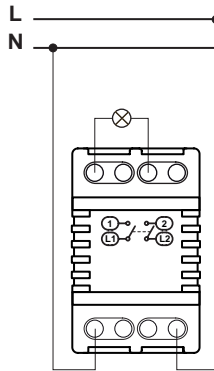

Double pole switch

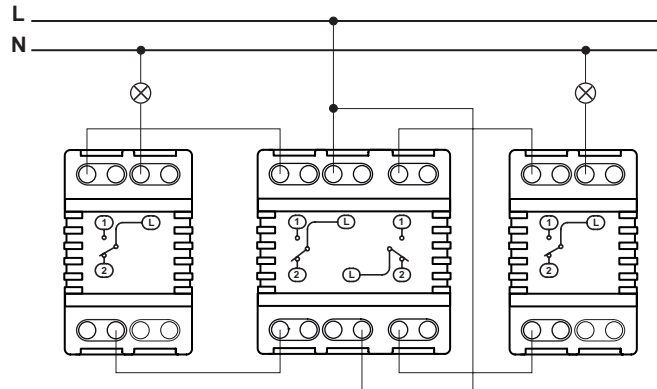

2 two-way switches + 1 double two-way switch acting on two different loads

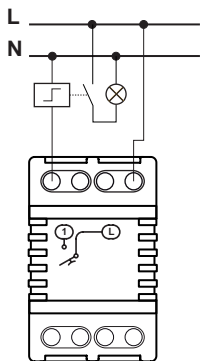

Push-button

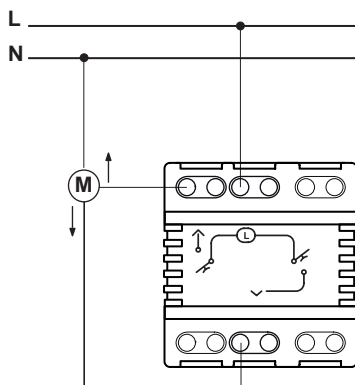

Switch or push-button for roller blinds

## Switches and push-buttons with locator lamps

### Connection examples

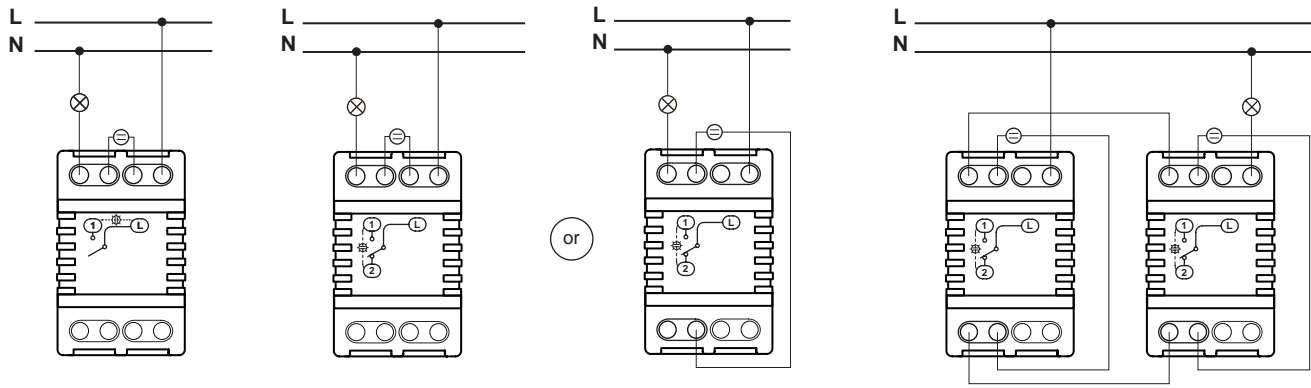

One-way switch with locator lamp

Two-way switch (used as a one-way-switch) with locator lamp

2 two-way switches with locator lamps

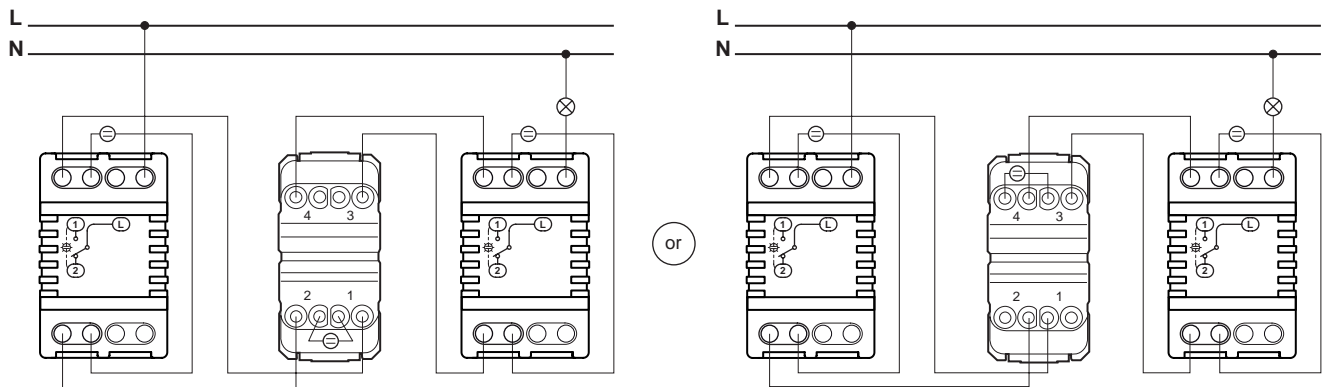

2 two-way switches + 1 intermediate switch with locator lamps

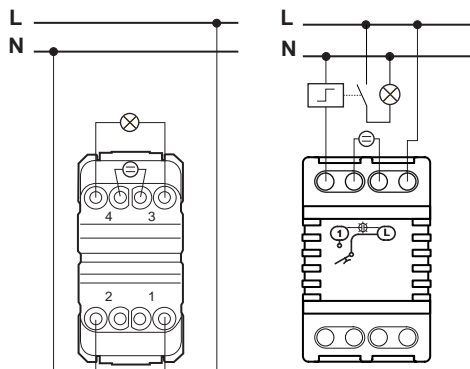

Double pole switch with locator lamp

Push-button with locator lamp

**Switches and push-buttons with indicator lamps**

**Connection examples**

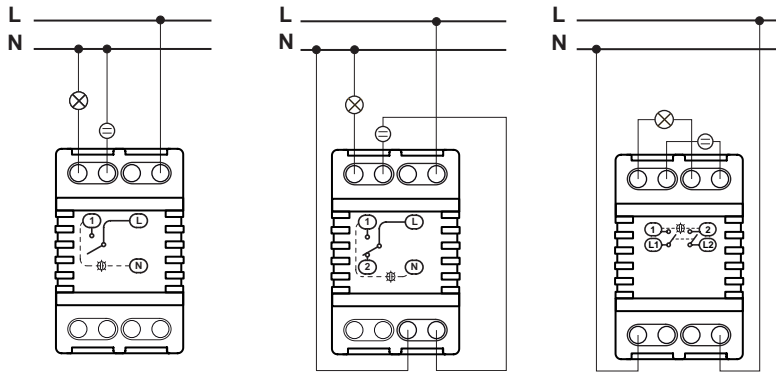

One-way with indicator lamp

Two-way switch  
 (used as a one-way-switch)  
 with indicator lamp

Double pole switch  
 with indicator lamp

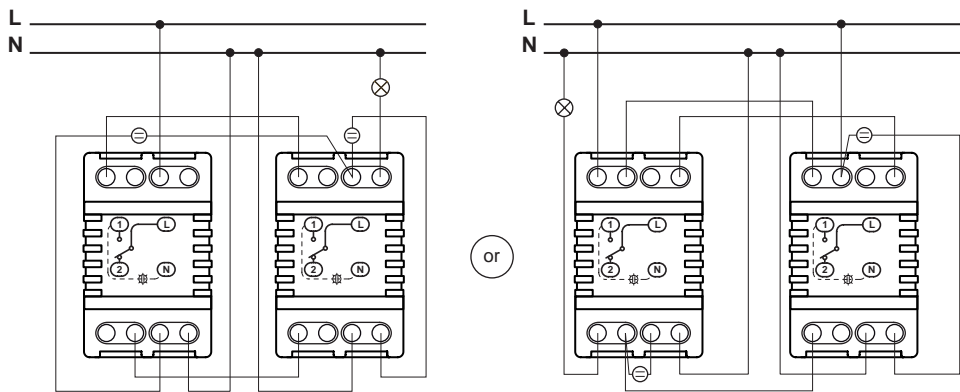

2 two-way switches with indicator lamps

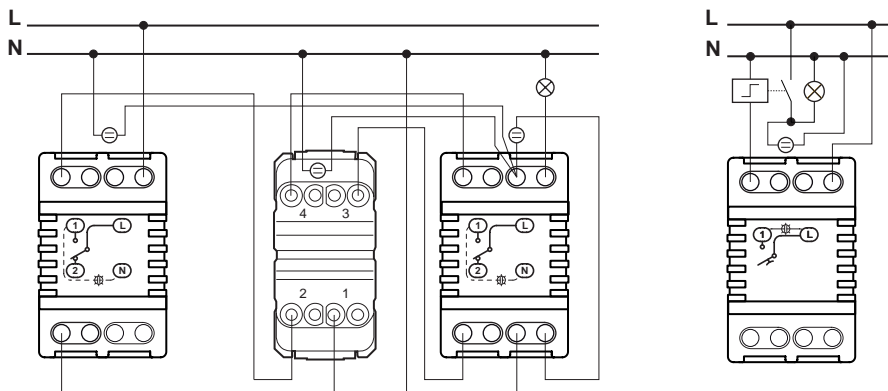

2 two-way switches + 1 intermediate switch with indicator lamps

Push-button  
 with indicator lamp

# Miniature circuit breaker switches Residual current device switches

## Area of application

- Miniature circuit breaker switches (MCB) and Residual current device switches (RCD) are used in addition to the safety device installed at the incoming end of the system. They can therefore significantly improve the protection of sensitive parts of the system against overloads, short-circuits and bypass faults.

- Areas of domestic premises susceptible to humidity (bathroom, kitchen, laundry room, etc.) in accordance with IEC/UNE-EN Electrical Installations of Buildings standards.

- Power outlets for supplying electronic equipment (PCs and peripherals, typewriters, electronic scales, cash registers, etc.).

It is also possible to reduce and locate faulty areas and to increase the availability of the rest of the installation upstream of this additional safety system.

- Such items cannot be installed in MGU8.00X surface-mounted boxes, U10.002 and U11.002 IP55 surface-mounted boxes and MGU61.002 IP44 cover and fixing frame assemblies.

## Standards

In accordance with EN 60898 and EN 61009-1:

- the electromagnetic part conforms to EN 60898
- the differential part conforms to EN 61009.

## Connections

### MCB connection

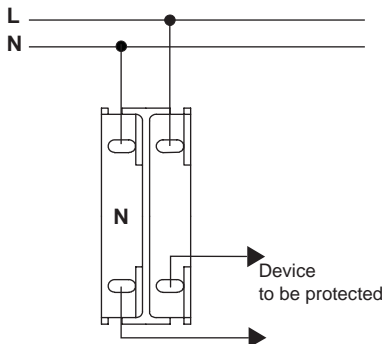

### RCD connection

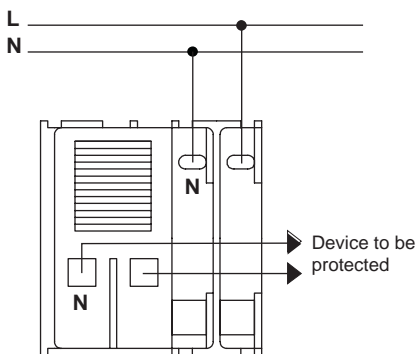

## Dimensions (mm)

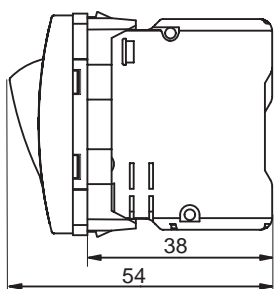

160

Life Is On

Schneider  
Electric

## Technical data

- Rated voltage: 230 V AC  $\pm 10\%$ , 50 Hz.
- MCB trip curve: the trip curve corresponds to the values specified in EN60898.

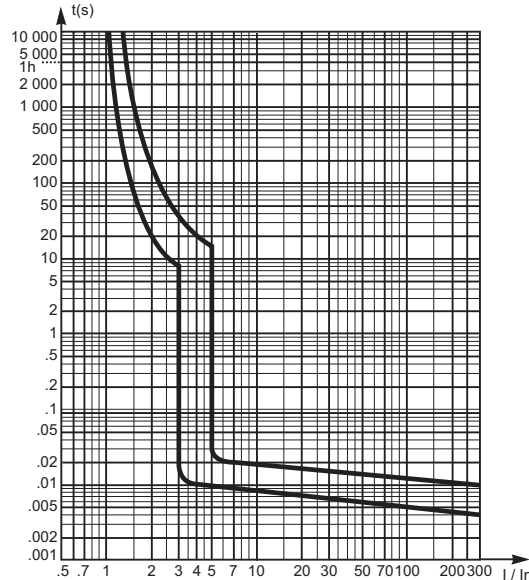

- MCB rated currents (rating) and breaking capacities:

| Reference   | Number of poles | Rating (A) | Breaking capacity (A) |
|-------------|-----------------|------------|-----------------------|
| MGU3.654.XX | 1               | 6          | 1500                  |
| MGU3.655.XX | 1               | 10         | 1500                  |
| MGU3.656.XX | 1               | 16         | 1500                  |
| MGU3.614.XX | 1 + N           | 10         | 3000                  |
| MGU3.615.XX | 1 + N           | 16         | 3000                  |

- RCD rated currents (rating) and breaking capacities:

| Reference   | Number of poles | Rating (A) | Breaking capacity (A) |
|-------------|-----------------|------------|-----------------------|
| MGU3.610.XX | 1 + N           | 6          | 1500                  |
| MGU3.611.XX | 1 + N           | 10         | 3000                  |
| MGU3.612.XX | 1 + N           | 16         | 3000                  |

- A circuit breaker installed on a vertical wall has a degree of protection to IP41.
- The device must be used in a dry, dust-free area with an ambient temperature between -5°C and 40°C.
- The circuit can be closed manually by turning the circuit breaker handle in the direction of the «I» symbol.
- The circuit can be opened manually by turning the circuit breaker handle in the direction of the «O» symbol, or automatically by thermal or magnetic action.
- With respect to the RCD, the circuit can also be opened by pressing the test button «T» and automatically by differential action.
- The test button «T» must be activated once a month.
- Fully protected rear screw terminals (IP2X) with toothed pressure plates and captive screws that can accept two 2.5 mm<sup>2</sup> conductors.
- The RCD sensitive to 10 mA can also operate in the presence of non-sinusoidal fault currents (AC currents with superimposed unidirectional pulse currents). They can consequently be classified, according to the terms of EN 61009-1, as «type A differential circuit breakers» that can be identified by the appropriate symbol.



## Technical data

### MGU3.630.XX

Fuse holder with a permissible maximum current of 10 A at 230 V AC for 6 x 32 mm fuses (not supplied).

### MGU3.631.XX

Fuse holder with a permissible maximum current of 16 A at 230 V AC for 8.5 x 31.5 mm, 00 type fuses (not supplied).

## Standards

- MGU3.630.XX: in accordance with EN 60127-6.
- MGU3.631.XX: in accordance with EN 60269.

## Fuse replacement

### MGU3.630.XX

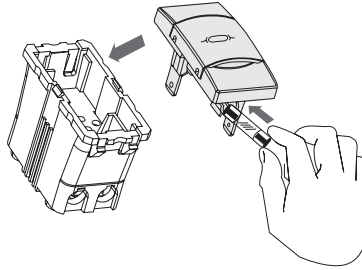

### MGU3.631.XX

Simply unscrew the fuse holder from the front face.

## Dimensions (mm)

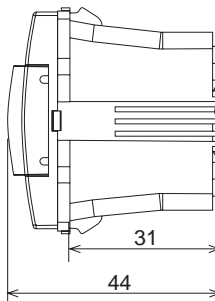

# Rotary electronic dimmer switches

## MGU3.510.XX - 400 VA, 1-10 V

### Area of application

- Regulation of different loads (see load table) for homes and buildings.
- Suitable for renovation as it allows replacement of a switch or a selector switch by a regulator without having to change cables.
- As the regulator reduces the current supplying the load, it allows considerable energy savings.

### Technical data

- Rated voltage: 230 V AC  $\pm$  10 %, 50 Hz.
- For fluorescent tubes  $\varnothing$  26 and 38 mm with 1-10 V adjustable electronic ballast.
- For 10 x 1-10V ballast with 36 W fluorescent tubes or 5 x 1-10V ballast, 2 x 18 W fluorescent tubes,  $\varnothing$  26 and 30 mm.
- External relay control: maximum of 50 x 1-10 V ballast.
- Fuse: 4 Ah, 230 V AC, 5 x 20 mm.
- Max. control current: 200 mA.
- Output power derating with 2 or 3 devices combining:

#### Configuration and number of combining devices

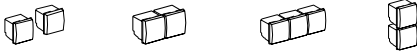

#### Output power derating

|      |      |      |      |
|------|------|------|------|
| 25 % | 25 % | 40 % | 50 % |
|------|------|------|------|

#### Load table

|                                       |         |         |         |         |         |          |         |         |         |
|---------------------------------------|---------|---------|---------|---------|---------|----------|---------|---------|---------|
| 25 °C<br>230 V<br>50 Hz<br>Max.<br>VA | 1<br>NO | 2<br>NO | 3<br>NO | 4<br>NO | 5<br>NO | 6<br>400 | 7<br>NO | 8<br>NO | 9<br>NO |
|---------------------------------------|---------|---------|---------|---------|---------|----------|---------|---------|---------|

- 1 - Incandescent lamps
- 2 - Halogen lamps
- 3 - Low voltage halogen lamps with ferromagnetic transformer
- 4 - Low voltage halogen lamps with electronic transformers
- 5 - Fluorescent lamps with conventional ballast
- 6 - Fluorescent lamps with dimmable electronic ballast (1- 10 V)
- 7 - Compact fluorescent lamps
- 8 - LED lamps
- 9 - Motors (single phase)

### Standards

In accordance with EN 60669-2-1.

### Use

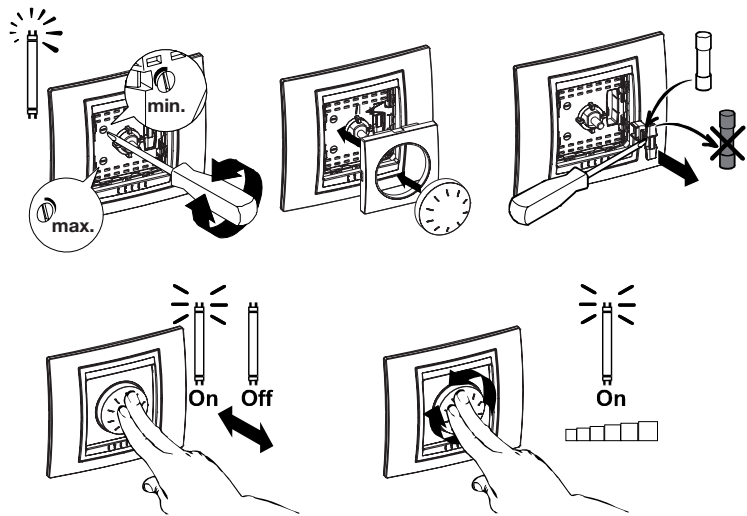

### Connections

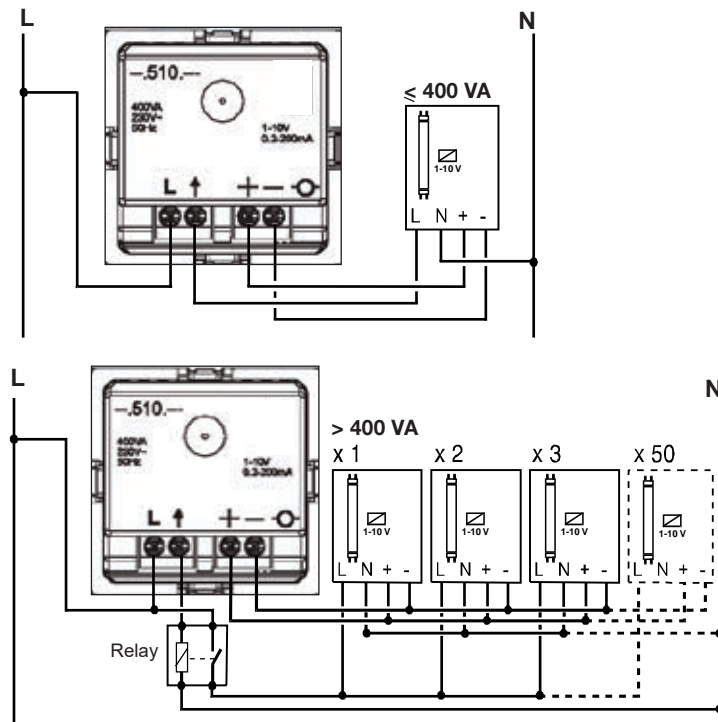

Connection terminals: screw connection for cables up to 2 x 2.5 mm<sup>2</sup>

### Dimensions (mm)

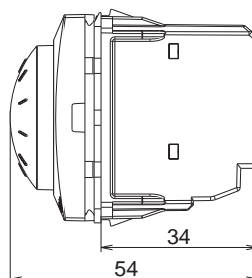

# Rotary electronic dimmer switches

## MGU3.511.XX - 40-400 W/VA

### Area of application

- Regulation of different loads (see load table) for homes and buildings.
- Suitable for renovation as it allows replacement of a switch or a two-way switch by a regulator without having to change cables.
- As the regulator reduces the current supplying the load, it allows considerable energy savings.

### Technical data

- Rated voltage: 230 V AC  $\pm$  10 % 50 Hz.
- Possibility of connection with a two-way switch.
- Fuse: 4 Ah-230 V AC, 5 x 20 mm.
- Output power derating with 2 or 3 devices combining:

#### Configuration and number of combining devices

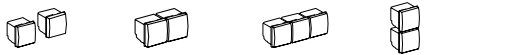

#### Output power derating

|      |      |      |      |
|------|------|------|------|
| 25 % | 25 % | 40 % | 50 % |
|------|------|------|------|

#### Load table

|                         | 1               | 2               | 3              | 4              | 5              | 6              | 7              |
|-------------------------|-----------------|-----------------|----------------|----------------|----------------|----------------|----------------|
| 25 °C<br>230 V<br>50 Hz |                 |                 |                |                |                |                |                |
| Max.<br>Min.<br>W/VA    | 400<br>40<br>40 | 400<br>40<br>40 | NO<br>NO<br>NO | NO<br>NO<br>NO | NO<br>NO<br>NO | NO<br>NO<br>NO | NO<br>NO<br>NO |

- 1 - Incandescent or halogen lamps
- 2 - Low voltage halogen lamps with ferromagnetic transformer
- 3 - Low voltage halogen lamps with electronic transformers
- 4 - Fluorescent lamps with conventional ballast or with dimmable electronic ballast (1- 10 V)
- 5 - Compact fluorescent lamps
- 6 - LED lamps
- 7 - Motors (single phase)

### Standards

In accordance with EN 60669-2-1.

### Use

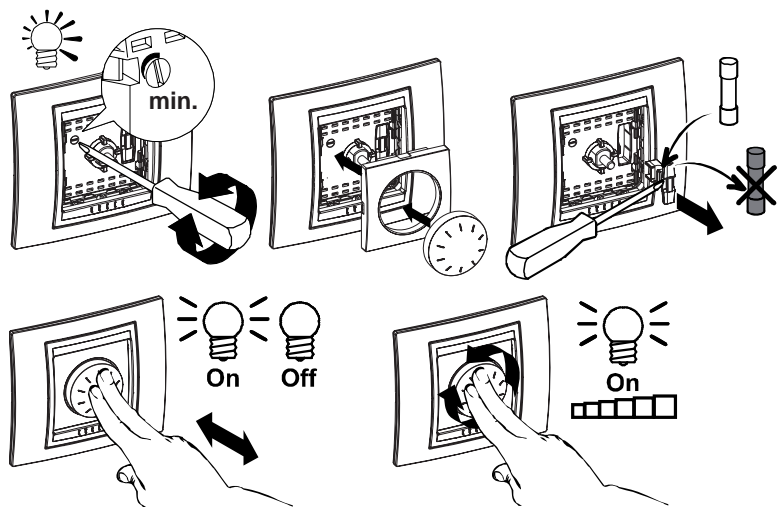

### Connections

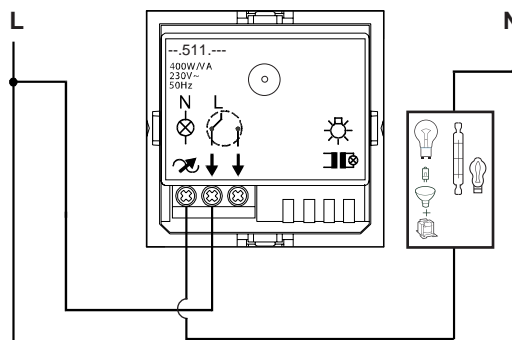

Connection terminals: screw connection for cables up to 2 x 2.5 mm<sup>2</sup>

### Substitution examples

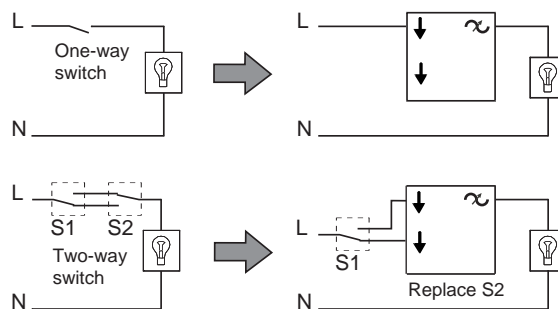

### Dimensions (mm)

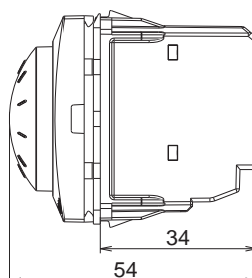

# Rotary electronic dimmer switches

## MGU5.512.XXZD - 40-1000 W/VA

### Area of application

- Regulation of different loads (see load table) for homes and buildings.
- Suitable for renovation as it allows replacement of a switch or a selector switch by a regulator without having to change cables.
- As the regulator reduces the current supplying the load, it allows considerable energy savings.

### Technical data

- Rated voltage: 230 V AC  $\pm$  10 %, 50 Hz.
- Output power derating with 2 or 3 devices combining:

#### Configuration and number of combining devices

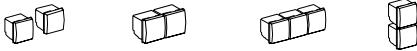

#### Output power derating

25 %      25 %      40 %      50 %

### Load table

|                         | 1          | 2          | 3  | 4  | 5  | 6  | 7         |
|-------------------------|------------|------------|----|----|----|----|-----------|
| 25 °C<br>230 V<br>50 Hz |            |            |    |    |    |    |           |
| Max.<br>Min.<br>W/VA    | 1000<br>40 | 1000<br>40 | NO | NO | NO | NO | 600<br>60 |

- 1 - Incandescent lamps or halogen lamps
- 2 - Low voltage halogen lamps with ferromagnetic transformer
- 3 - Low voltage halogen lamps with electronic transformers
- 4 - Fluorescent lamps with conventional ballast or with dimmable electronic ballast (1- 10 V)
- 5 - Compact fluorescent lamps
- 6 - LED lamps
- 7 - Motors (single phase)

### Standards

In accordance with EN 60669-2-1.

### Use

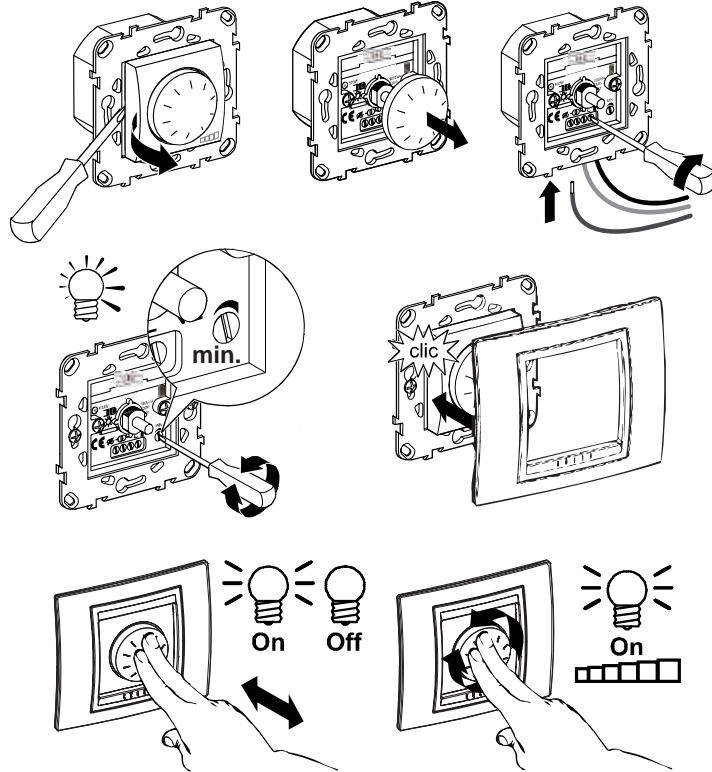

### Connections

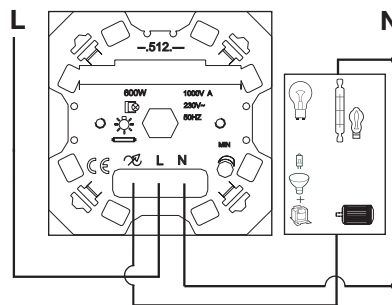

Connection terminals: screw connection for cables up to 2 x 2.5 mm<sup>2</sup>

### Dimensions (mm)

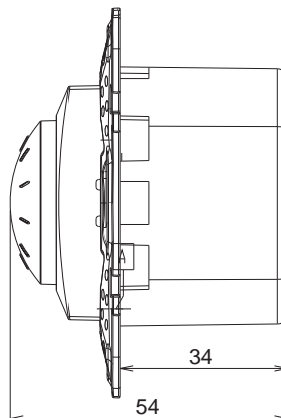

# Rotary electronic dimmer switches

## MGU3.559.XX - 40-400 W - dual voltage

### Area of application

- Regulation of different loads (see load table) for homes and buildings
- Suitable for renovation as it allows replacement of a switch by a regulator without having to change cables.
- As the regulator reduces the current supplying the load, it allows considerable energy savings.

### Technical data

- Rated voltage: 127/ 230 V AC, 50/60 Hz.
- Connectable as switch.
- Fuse: 4 Ah- 230 V AC, 5 x 20 mm.

2 devices in the same housing is not allowed



### Load table

| <br>25 °C<br>50/60 Hz | 1   | 2  | 3  | 4  | 5  | 6  |
|-----------------------|-----|----|----|----|----|----|
| 127 V AC              |     |    |    |    |    |    |
| Max. W/WA             | 250 | NO | NO | NO | NO | NO |
| Min. W/WA             | 40  | NO | NO | NO | NO | NO |
| 230 V AC              |     |    |    |    |    |    |
| Max. W/WA             | 400 | NO | NO | NO | NO | NO |
| Min. W/WA             | 60  | NO | NO | NO | NO | NO |

- 1 - Incandescent lamps or halogen lamps
- 2 - Low voltage halogen lamps with ferromagnetic transformer or with electronic transformers
- 3 - Fluorescent lamps with conventional ballast or with dimmable electronic ballast (1- 10 V)
- 4 - Compact fluorescent lamps
- 5 - LED lamps
- 6 - Motors (single phase)

### Standards

In accordance with IEC 60669-2-1, 2002-Ed.4, IEC 60669-1, 1998-Ed.3 + A1, 1999.

### Use

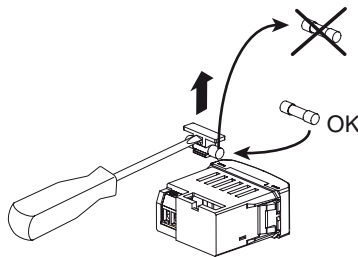
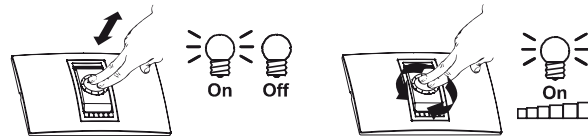

### Connections

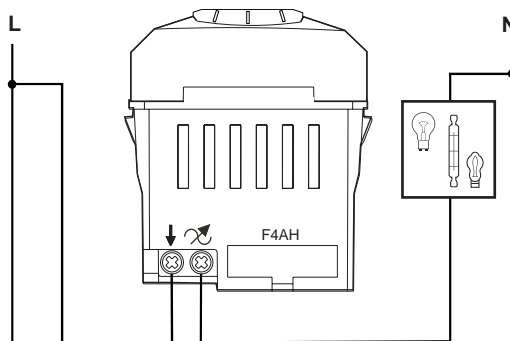

Connection terminals: screw connection for cables up to 2 x 2.5 mm<sup>2</sup>.

### Dimensions (mm)

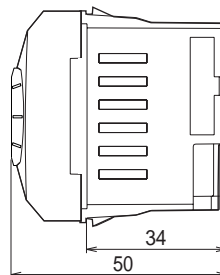

# Push-button dimmer switches MGU3.515.XX - 20-350 W/VA

## Area of application

- Regulation of different loads (see load table) for homes and buildings.
- Suitable for renovation as it allows replacement of a switch or a selector switch by a regulator without having to change cables.
- As the regulator reduces the current supplying the load, it allows considerable energy savings.

## Technical data

- Rated voltage: 230 V AC  $\pm$  10 %, 50 Hz.
- Conventional push-buttons with or without indicator lamp can be used for on/off control and regulation of the load:
  - maximum number of push-buttons without indicator lamp: 25
  - maximum number of push-buttons with indicator lamp: 5 (1.5 A).
- Output power derating with 2 or 3 devices combining:

### Configuration and number of combining devices

|      |      |      |      |
|------|------|------|------|
|      |      |      |      |
| 25 % | 25 % | 40 % | 50 % |

### Load table

|  | 1     | 2   | 3   | 4   | 5  | 6  | 7  | 8   | 9   |
|--|-------|-----|-----|-----|----|----|----|-----|-----|
|  | 25 °C |     |     |     |    |    |    |     |     |
|  | 230 V |     |     |     |    |    |    |     |     |
|  | 50 Hz |     |     |     |    |    |    |     |     |
|  | 250   | 350 | 350 | 300 | NO | NO | NO | 200 | 350 |
|  | 20    | 20  | 20  | 20  |    |    |    | 20  | 20  |

- 1 - Incandescent lamps
- 2 - Halogen lamps
- 3 - Low voltage halogen lamps with ferromagnetic transformer or electronic transformer
- 4 - Low voltage halogen lamps with toroidal transformers
- 5 - Fluorescent lamps with conventional ballast or dimmable electronic ballast (1- 10 V)
- 6 - Compact fluorescent lamps
- 7 - LED lamps
- 8 - Ventilators
- 9 - Heaters

## Standards

In accordance with EN 60669-2-1.

## Use

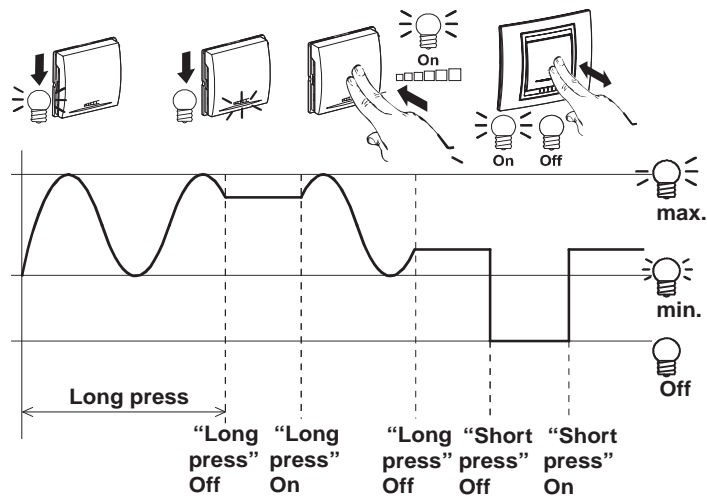
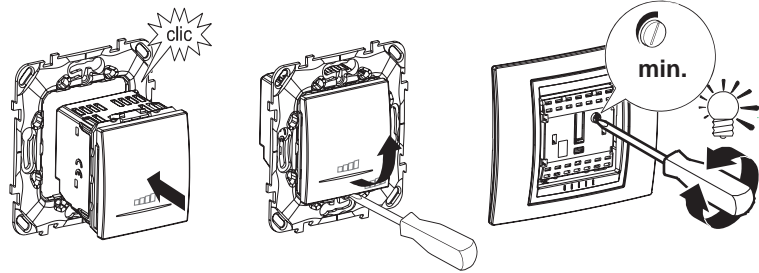

## Connections

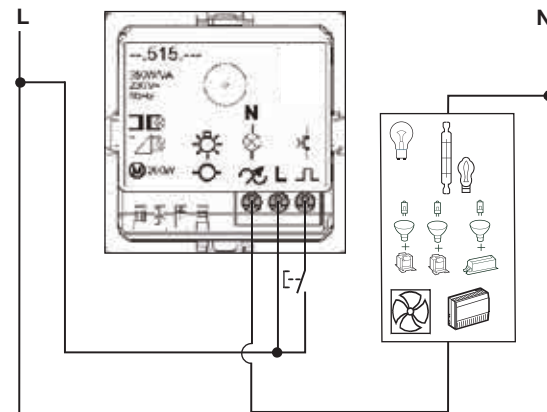

Connection terminals: screw connection for cables up to 2 x 2.5 mm<sup>2</sup>

## Dimensions (mm)

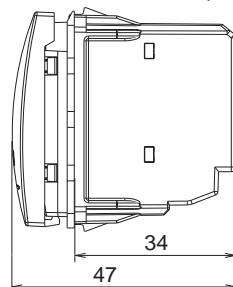

# Movement and presence detectors

## MGU3.524.XX- 300 W

### Area of application

- The movement detection control switch switches on the loads, it controls when someone passes through the area of action of the sensor.
- It is suitable for different loads (see load table).
- It can be installed indoors in flush-mounted installations and in surface-mounted boxes.
- The control switch allows considerable energy savings since the load is supplied only when people are present.

### Technical data

- Rated voltage: 230 V AC  $\pm$  10 %, 50 Hz.
- Movement detection area:
  - 10 x 20 m (PIR mounting height: 2.15 m)
  - 9 x 18 m (PIR mounting height: 1.2 m).
- Presence detection area:
  - 6 x 12 m (PIR mounting height: 2.15 m).
  - 5 x 10 m (PIR mounting height: 1.2 m).
- Detection angle: full 180°, partial 90° left or right.
- Selection modes:
  - Manual; the load is controlled by a push-button,
  - Automatic; the load is controlled by the detection of movement and a pre-defined luminosity threshold.
- Two detectors can be used in parallel, allowing a larger detection area coverage.
- Time delay: adjustable 2 s to 20 min.
- Luminosity threshold: adjustable 5 to 1000 lux.

### Load table

|                             |                      |              |              |              |              |              |              |
|-----------------------------|----------------------|--------------|--------------|--------------|--------------|--------------|--------------|
| <br>25 °C<br>230 V<br>50 Hz | <br><b>1</b>         | <br><b>2</b> | <br><b>3</b> | <br><b>4</b> | <br><b>5</b> | <br><b>6</b> | <br><b>7</b> |
|                             | Max.<br>Min.<br>W/WA | 300<br>40    | NO           | NO           | NO           | NO           | NO           |

- 1 - Incandescent lamps, halogen lamps or heaters (Pf > 0.9)
- 2 - Low voltage halogen lamps with ferromagnetic or toroidal transformer or with electronic transformer
- 3 - Fluorescent lamps with conventional ballast or dimmable electronic ballast (1- 10 V)
- 4 - Compact fluorescent lamps
- 5 - LED lamps
- 6 - Ventilators
- 7 - Contactors

### Standards

In accordance with EN 60669-2-1.

### Use

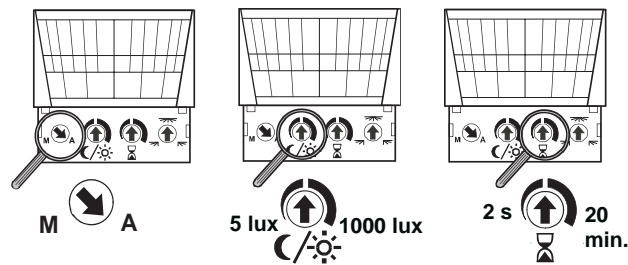
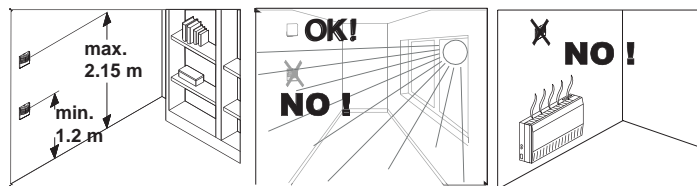

**M:** manual: the load is controlled by a push-button  
**A:** automatic: the load is controlled by the detection of movement and a pre-defined luminosity threshold.

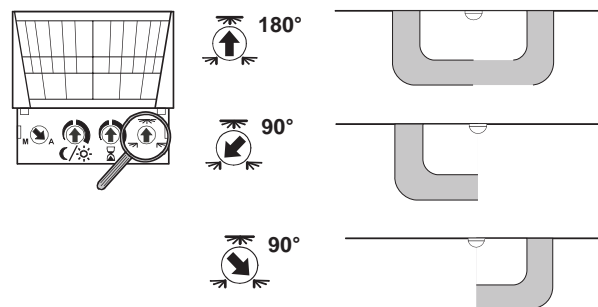

### Connections

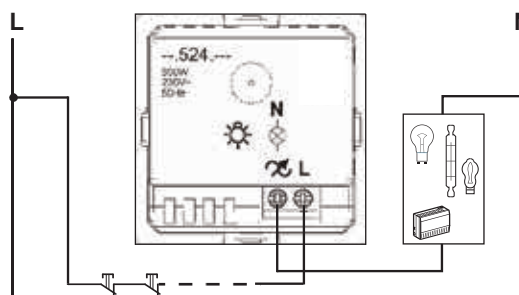

- Connection terminals: screw connection for cables up to 2 x 2.5 mm<sup>2</sup>
- Use of a maximum of 5 normally closed push-buttons, for manual override.

### Substitution examples

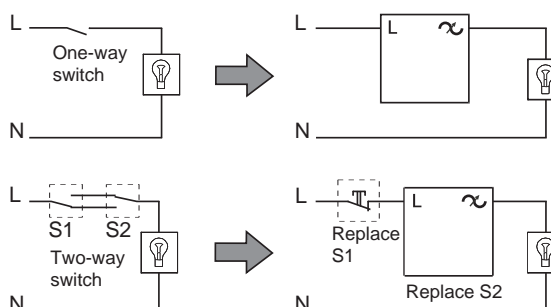

# Movement and presence detectors

## MGU3.524.XX - 300 W (cont'd)

### Detection areas

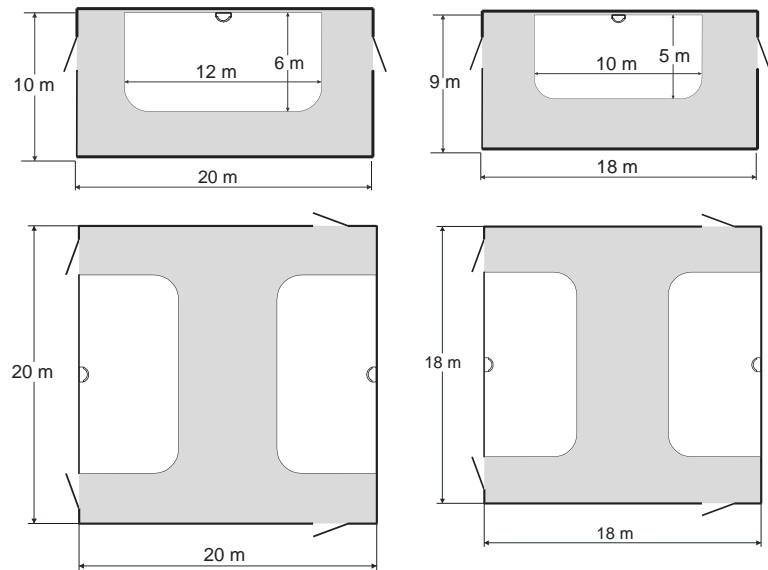

Maximum mounting height: 2.15 m

Maximum mounting height: 1.2 m

- Presence detection area
- Movement detection area

| Number of PIR in parallel | 2     | 3     | 4     | 5     |
|---------------------------|-------|-------|-------|-------|
| Max. load                 | 300 W | 300 W | 300 W | 300 W |
| Min. load                 | 50 W  | 80 W  | 100 W | 140 W |

### Dimensions (mm)

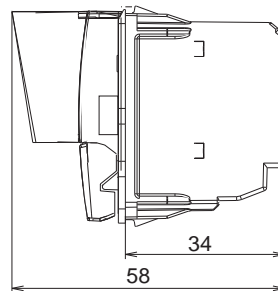



# Movement and presence detectors

## MGU3.525.XX- 2300 W

### Area of application

- The movement detection control switches on the loads, it controls when someone passes through the area of action of the sensor.
- It is suitable for different loads (see load table).
- It can be installed indoors in flush-mounted installations and in surface-mounted boxes.
- The control switch allows considerable energy savings since the load is supplied only when people are present.

### Technical data

- Rated voltage: 230 V AC  $\pm$  10 %, 50 Hz.
- Movement detection area:
  - 10 x 20 m (PIR mounting height: 2.15 m)
  - 9 x 18 m (PIR mounting height: 1.2 m).
- Presence detection area:
  - 6 x 12 m (PIR mounting height: 2.15 m).
  - 5 x 10 m (PIR mounting height: 1.2 m).
- Detection angle: full 180°, partial 90° left or right.
- Selection modes:
  - Manual; the load is controlled by a push-button,
  - Automatic; the load is controlled by the detection of movement and a pre-defined luminosity threshold.
  - Slave; slaves detectors are used in conjunction with a master detector, allowing a larger detection area coverage.
- Time delay: ajustable 2 s to 20 min.
- Luminosity threshold: ajustable 5 to 1000 lux.

### Load table

|                         | 1    | 2    | 3    | 4    | 5    | 6   | 7   | 8   | 9    | 10  |
|-------------------------|------|------|------|------|------|-----|-----|-----|------|-----|
| 25 °C<br>230 V<br>50 Hz |      |      |      |      |      |     |     |     |      |     |
| Max. W/vA               | 2300 | 2000 | 1050 | 1150 | 2000 | 500 | 500 | 200 | 2300 | 200 |

- 1 - Incandescent lamps
- 2 - Halogen lamps
- 3 - Low voltage halogen lamps with ferromagnetic transformer
- 4 - Fluorescent lamps with conventional ballast, Pf > 0.9
- 5 - Low voltage halogen lamps with electronic transformers
- 6 - Compact fluorescent lamps
- 7 - LED lamps
- 8 - Ventilators
- 9 - Heaters
- 10 - Contactors

### Standards

In accordance with EN 60669-2-1.

### Use

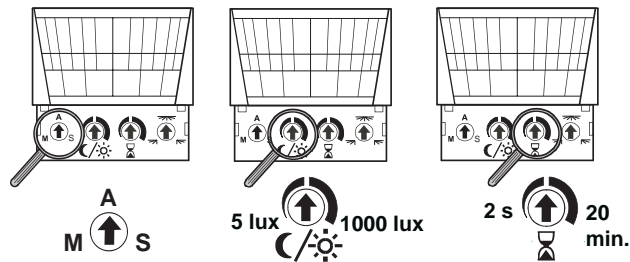
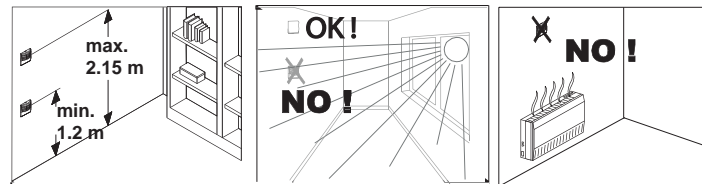

- M:** manual; the load is controlled by a push-button  
**A:** automatic; the load is controlled by the detection of movement and a pre-defined luminosity threshold.  
**S:** slave; slaves detectors are used in conjunction with a master detector, allowing a larger detection area coverage.

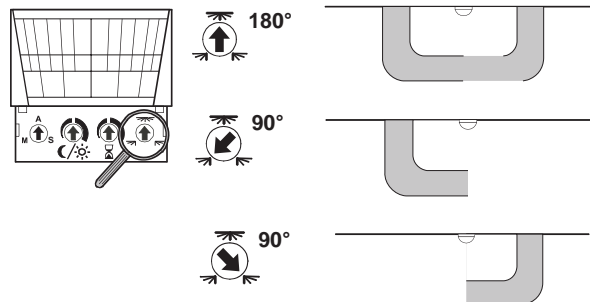

### Connections

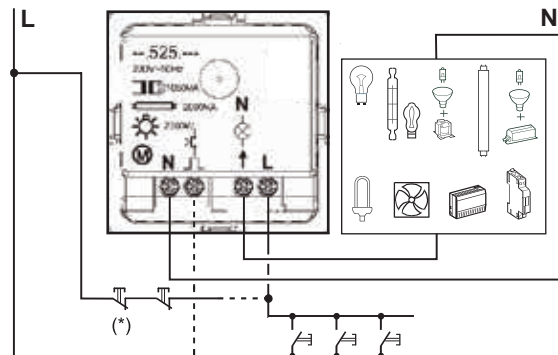

Connection terminals: screw connection for cables up to 2 x 2.5 mm<sup>2</sup>  
 (\*) Use of a maximum of 5 normally closed push-buttons, for manual override.

### Substitution examples

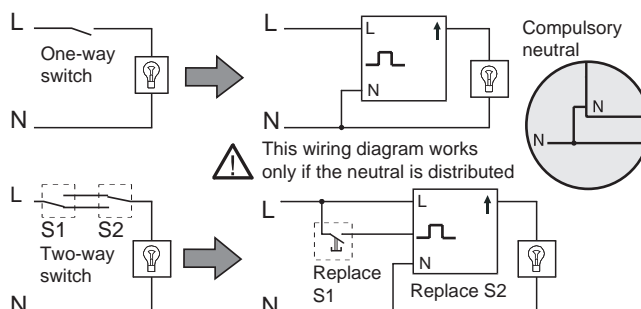

# Movement and presence detectors

## MGU3.525.XX - 2300 W (cont'd)

### Detection areas

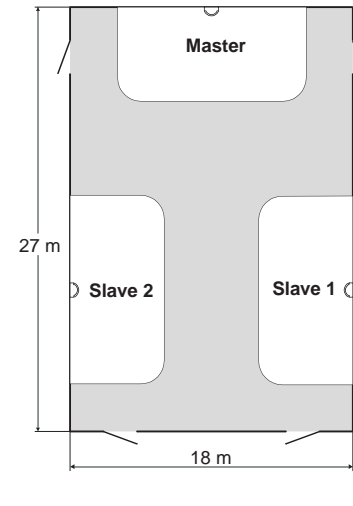
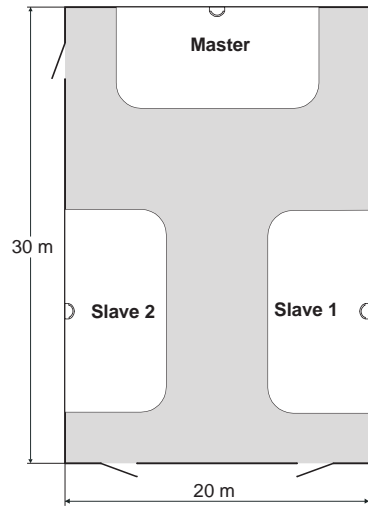
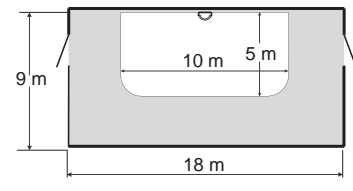
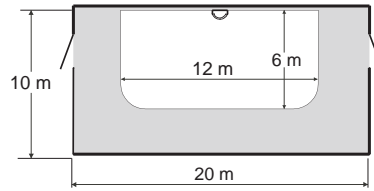

Maximum mounting height: 2.15 m

Maximum mounting height: 1.2 m

Slaves allow coverage of a larger area

- Presence detection area
- Movement detection area

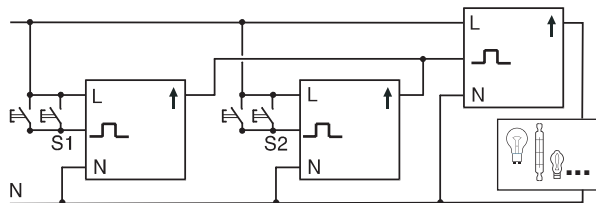

- Max 5 slaves to 1 master
- Max 5 push-buttons to 1 slave
- Use normally open push-button
- Push-buttons are optional with master PIR in automatic mode
- Slave PIR time delay should be less than Master PIR time delay

### Dimensions (mm)

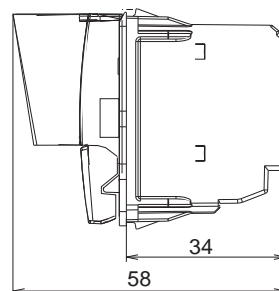

# Thermostats

## MGU3.501.XX- 8 A basic thermostat

### Area of application

- Residential sector:
  - homes with local heating
  - homes with central heating
  - homes with local air-conditioning.
- Tertiary sector:
  - environments with fan air-conditioning
  - environments with central heating and zone valves.
- Can be used on a boiler or circulating pump circuit (heating) or on the air-conditioning power circuit. .

### Technical data

- Rated voltage: 230 V AC  $\pm$  10 %, 50 Hz.
- Settings range: + 5 °C to + 30 °C.
- Accuracy: 0.5°C.
- The comfort temperature is set via a graduated dial on the front panel.
- Load types:
  - 8 A (resistive)
  - 2 A, Pf (cos $\phi$ ) = 0.6 (inductive).
- Free potential relay contact.
- Protection against thermal overloads: the mechanism is protected against a connected load that is greater than the permissible load.
- A green LED indicates that a voltage is present.
- Red/blue dual-coloured LED: heating or cooling indication
  - red indicates that the relay is enabled and that the comfort temperature is higher than the ambient room temperature (heating application)
  - blue indicates that the relay is not enabled and that the comfort temperature is lower than the ambient room temperature (air-conditioning application).

### Standards

- In accordance with:
- EN 607320-2-9.
  - LV and EMC directives.

### Use

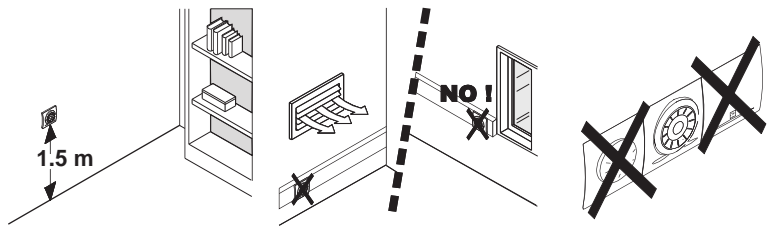

### Connections

#### Heating

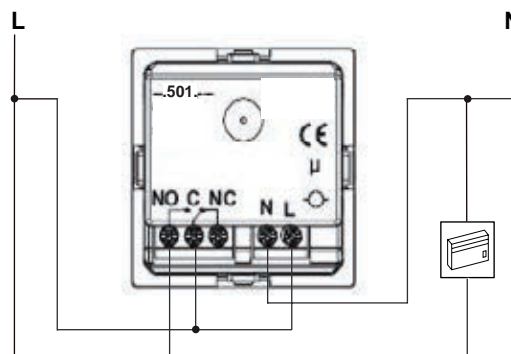

#### Air-conditioning

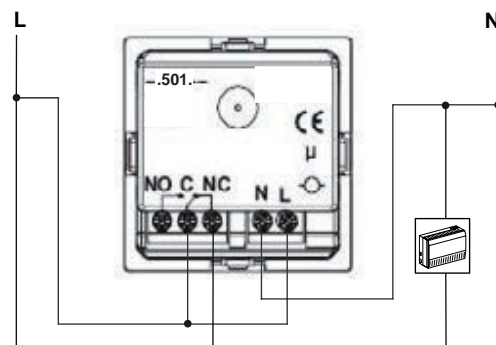

- Terminal identification: L (phase), N (neutral), C (common), NO (normally open contact) and NC (normally closed contact).
- Connection terminals: screw connection for cables up to 2 x 2.5 mm<sup>2</sup>

### Dimensions (mm)

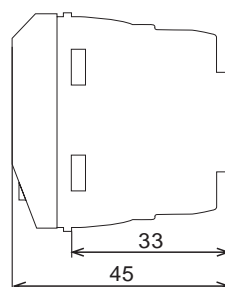

# Thermostats

## MGU3.503.XX - MGU5.503.XX ZD - 10 A floor thermostat

### Area of application

Floor heating for homes.

### Technical data

- Rated voltage: 230 V AC  $\pm$  10 %, 50 Hz.
- Settings range: + 5 °C to + 45 °C.
- Accuracy: 0.5 °C.
- The comfort temperature is set via a graduated dial on the front panel.
- Load types: 10 A, resistive load,  $\cos\phi = 1$  (2300W).
- Indication:
  - green LED indicates that a voltage is present.
  - red LED indicates that the relay is enabled and that the comfort temperature is higher than the ambient room temperature.
- A floor temperature sensor is delivered with each floor thermostat:
  - impedance: 10 k $\Omega$  at 25°C, NTC sensor
  - length: 4 m.

### Use

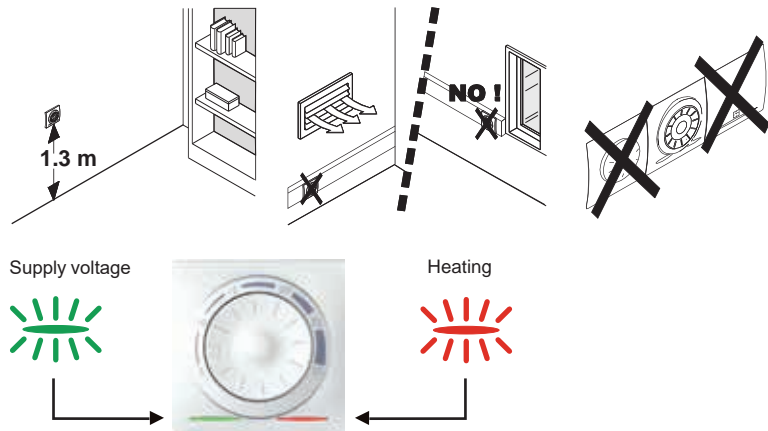

### Standards

- In accordance with:
- EN 607320-2-9.
  - LV and EMC directives.

### Connections

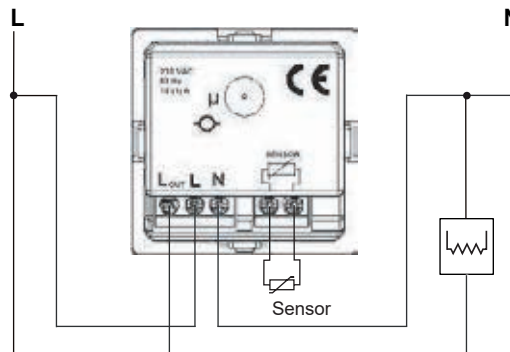

Connection terminals:

- L and N: screw connection for cables up to 2 x 2.5 mm<sup>2</sup>
- sensor: screw connection for cables up to 2 x 1.5 mm<sup>2</sup>.

### Dimensions (mm)

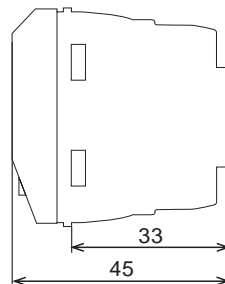

# Weekly-programmable thermostats

## MGU3.505.XX - 8 A resistive/5 A inductive

### Area of application

- Residential sector:
  - homes with local heating
  - homes with central heating
  - homes with local air-conditioning.
- Tertiary sector:
  - environments with fan air-conditioning
  - environments with central heating and zone valves.
- Can be used on a boiler or circulating pump circuit (heating) or on the air-conditioning power circuit.

### Technical data

- Rated voltage: 230 V AC  $\pm$  10 %, 50 Hz.
- Application 1: the heating is connected via terminals C (common) and NO (normally open).
- Application 2: the air-conditioning is connected via terminals C (common) and NC (normally closed).
- Standard programming (user-modifiable).
- Maximum number of weekly program settings: 1.
- Maximum number of programmable changes: no limit.
- Heating (Heat) or air-conditioning (Cool) can be programmed in INSTALLER PARAMETERS.
- Memory with no 230 V AC power supply: 7 days.
- Relative operating humidity: 20 to 85%.
- Programmable temperatures: Tmax, Tmin, frost protection and differential.
- Ambient room temperature display: 0 to 45°C (tenths).
- Selectable temperature set point: increments of 0.5°C.
- Operating temperature: 0 to 50°C.
- Settings range: 5 to 35°C.
- Storage temperature: -5 to 55°C.
- Relay contact interrupting capacity: 8 A resistive, 5 A inductive.
- Type of contact: free potential.
- Type of device to EN60730: type 1B.
- Software class: A.
- Device class: II.

### Standards

In accordance with EN 60730-2-9.

### Use

#### User data

- **AUTO:** The automatic thermostat function switches the heating or air-conditioning on or off according to pre-programmed times and temperatures.
- **MAN:** The manual thermostat function allows you to select the required temperature at any given time. It cancels the automatic function.
- **Tmin:** Tmin is the so-called economy temperature, namely the temperature at which the environment is maintained during the user's absence or for the purposes of minimum comfort. In theory, it is used during the day or at night-time. The values for this temperature category are normally between 18 °C and 20 °C.
- **Tmax:** Tmax is the so-called comfort temperature. It is the temperature chosen to give a sensation of maximum comfort. The comfort temperature values are normally between 21 °C and 22 °C.
- **SUITCASE:** The thermostat shutdown function is used for holiday periods or periods of absence during which only the frost-protection function is enabled. The day this function is to come into effect can be set in AUTO mode.
- **CAL:** Temperature sensor calibration : the temperature measured by the thermostat is adjusted to match the actual temperature in the event of the equipment being affected by nearby heat sources or draughts. The temperature can be increased or lowered permanently by up to 5 °C.
- **DIF:** Differential : the differential is the variation in temperature required to switch the thermostat on or off. The values for this parameter are normally 0.3 °C. In other words, if a differential of 0.5 °C is programmed and the comfort temperature is 22 °C, the thermostat switches on at 21.5 °C and off at 22 °C.
- **Frost-protection:** This is the frost-protection temperature, namely the temperature at which the heating switches on, even if the thermostat is switched off or in SUITCASE mode. This temperature is usually 6 °C. Thus, when the thermostat measures a temperature of 6 °C, it switches on the heating to prevent the pipes or other units in the house from freezing.

#### Keys



#### Menu/ On -Off

This key is used to select the various programming states in turn. Press OK to access the various states. Press this key for five seconds (only from AUTO or MANUAL mode) to switch off the weekly thermostat. Press again to restart the thermostat.



#### Increase values/ SELECT

The programming (PRG) mode is used to select Tmax, Tmin and frost-protection (\*) in turn.



#### Decrease values/ COPY

The programming mode (PRG) is used to copy the current day's schedule to the following day. When COPY flashes, press OK to confirm.



#### Confirm values and actions/ Holiday mode

Press this key for five seconds (only from AUTO or MANUAL mode) to switch to SUITCASE mode (time-delayed disconnect for holiday purposes).



Simultaneously press the MENU and OK keys for 10 s (only from AUTO mode) to restore the original parameters. Press the «▲» and «▼» keys for 5 s (only from AUTO mode) to access INSTALLER PARAMETERS.



Press the «▲» and «▼» keys for 5 s (only from AUTO mode) to access INSTALLER PARAMETERS.

#### Automatic heating programming

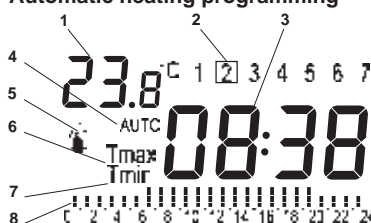

#### Air-conditioning programming

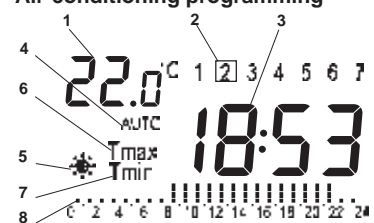

- 1 - Ambient room temperature in °C
- 2 - Day indicator
- 3 - Time indicator
- 4 - AUTO indicator: automatic function
- 5 - Heating or air-conditioning indicator: On (●) or On (\*)
- 6 - Tmax indicator: comfort temperature indicator
- 7 - Tmin indicator: economy temperature indicator
- 8 - Temperature/ time (0-24) indicator bar:
  - Tmax
  - Tmin
  - Frost protection (\*)

# Weekly-programmable thermostats

## MGU3.505.XX- 8 A resistive/ 5 A inductive (cont'd)

### Installation

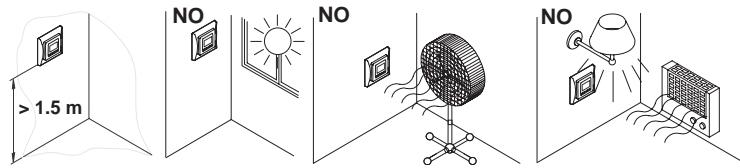

### Connections

#### Heating

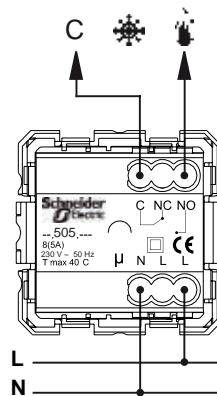

#### Air-conditioning

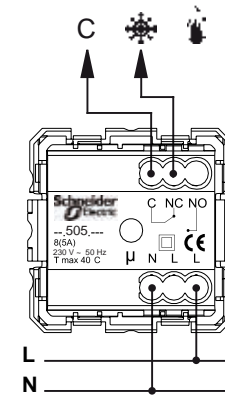

- Terminal identification : L (phase), N (neutral), C (common), NO (normally open) and NC (normally closed).
- The heating is connected via terminals C and NO.
- The air-conditioning is connected via terminals C and NC.
- Connection terminals: screw connection for cables up to 2 x 1.5 mm<sup>2</sup>.

### Dimensions

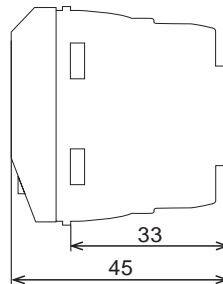

# Unica

## Technical information

### Time delay switches

#### MGU3.535.XX

### Area of application

- Installation in toilets, corridors, staircases, etc.
- Pulse-type switch on of the load and automatic disconnection when the programmed time limit has expired.
- Incorporated blue locator lamp.

### Technical data

- Rated voltage: 230 V AC  $\pm$  10 %, 50 Hz.
- Technology: relay.
- Maximum load: 8 A.
- Connection time setting by potentiometer.
- Setting time: from 2 s to 12 min.
- Conventional push-buttons with or without indicator lamp can be used for on/off control of the load:
  - maximum number of push-buttons without indicator lamp: 25,
  - maximum number of push-buttons with indicator lamp: 5.
- Output power derating with 2 or 3 devices combining:

#### Configuration and number of combining devices

|      |      |      |      |
|------|------|------|------|
|      |      |      |      |
| 25 % | 25 % | 40 % | 50 % |

#### Load table

| Max.                    | 1      | 2      | 3       | 4      | 5                 | 6    | 7   | 8      |
|-------------------------|--------|--------|---------|--------|-------------------|------|-----|--------|
| 25 °C<br>230 V<br>50 Hz |        |        |         |        |                   |      |     |        |
|                         | 1800 W | 1300 W | 1000 VA | 1800 W | 8 A<br>35 $\mu$ F | 60 W | 3 A | 1800 W |

- 1 - Incandescent lamps
- 2 - Halogen lamps
- 3 - Low voltage halogen lamps with ferromagnetic transformer
- 4 - Low voltage halogen lamps with electronic transformers
- 5 - Fluorescent lamps with conventional ballast
- 6 - Compact fluorescent lamps
- 7 - Ventilators
- 8 - Heaters

### Standards

In accordance with EN 60669-2-1.

### Use

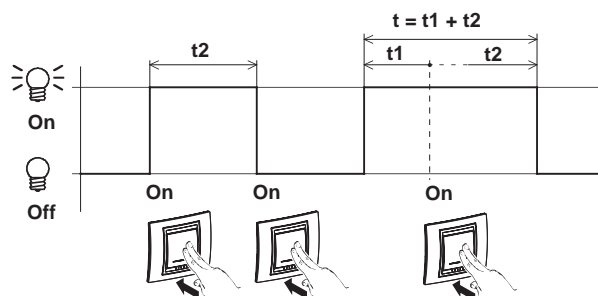
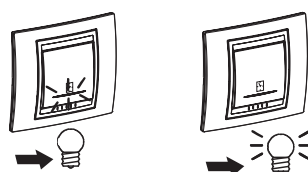
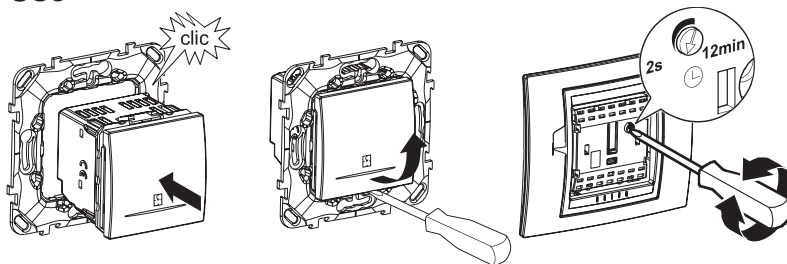

### Connections

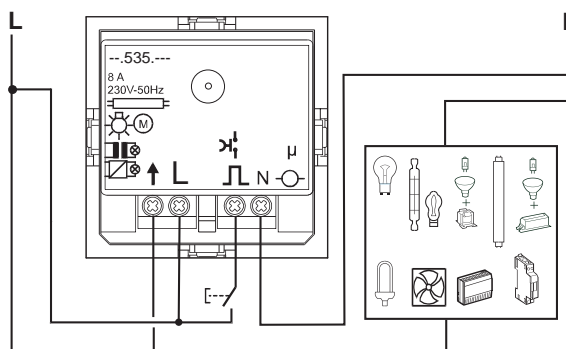

Connection terminals: screw connection for cables up to 2 x 2.5 mm<sup>2</sup>

### Dimensions

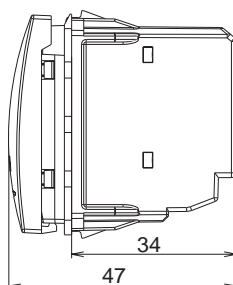

# Unica

## Technical information

### Time delay switches

#### MGU3.535.XX

### Area of application

The programmable time switch is used to control the loads according to a set schedule. It is programmed in intervals. An interval can represent switching on or off, depending on the time and day programmed. The intervals are displayed on the screen.

### Technical data

- Rated voltage: 230 V AC  $\pm$  10 %, 50 Hz.
- Maximum number of intervals: 28 (56 On/Off actions).
- Memory with no 230 V AC power supply: 7 days.
- Relative operating humidity displayed: 20 % to 85 %.
- Ambient room temperature display: 0 to 50 °C (tenths).
- Minimum interval duration: 1 min.
- Operating temperature: 0 to 50 °C.
- Storage temperature: -5 to 55°C.
- Type of contact: free potential.
- Type of device to EN60669-2-1: 1B.
- Software class: A.
- Device class: II.

### Load table

|  |           |           |         |         |         |         |         |         |         |
|--|-----------|-----------|---------|---------|---------|---------|---------|---------|---------|
| 25 °C<br>230 V<br>50 Hz<br>Max.<br>WVA | 1<br>1200 | 2<br>1000 | 3<br>NO | 4<br>NO | 5<br>NO | 6<br>NO | 7<br>NO | 8<br>NO | 9<br>XX |
|--|-----------|-----------|---------|---------|---------|---------|---------|---------|---------|

- 1 - Incandescent lamps or halogen lamps
  - 2 - Low voltage halogen lamps with ferromagnetic transformer
  - 3 - Low voltage halogen lamps with electronic transformers
  - 4 - Fluorescent lamps with conventional ballast
  - 5 - Compact fluorescent lamps
  - 6 - LED lamps
  - 7 - Ventilators
  - 8 - Heaters
  - 9 - Contactors
- A contactor should be used for loads higher or different from those mentioned.

### Standards

In accordance with EN 60669-2-1.

### Use

#### User data

- **AUTO:** The automatic programmable time switch function connects or disconnects the load according to the programmed interval times.
- **MAN:** The manual programmable time switch function allows you to connect the load at a time that is not programmed.
- **INTERVAL:** Period of time between connection and disconnection, depending on the time and day programmed.
- **SUITCASE:** This function prevents the time switch from being set during holiday periods or periods of absence. The day this function is to come into effect can be set in AUTO mode.

#### Keys

- MENU** **Menu/ On-Off**  
This key is used to select the different programming states in turn. Press OK to access the various states.  
Press this key for 5 s in AUTO mode to switch to MANUAL mode. The MANUAL mode is used to connect or disconnect the load.
- ▲** **Increase values/ SELECT**  
During programming, this function is used to choose sequentially between On and Off. When MEM (memory) is displayed, it is possible to choose between Mod (modify memory) and Del (partial programming deletion).
- ▼** **Decrease values/ COPY**  
During programming, this button allows copying the program of the current day to the next day. It allows selecting between the MEM and COPY menus.
- COPY** **OK** **Confirm values and actions/ Holiday mode**  
Press this key for 5 s (only from AUTO mode) to switch to SUITCASE mode (time-delayed disconnect for holiday purposes).

#### Automatic mode screen

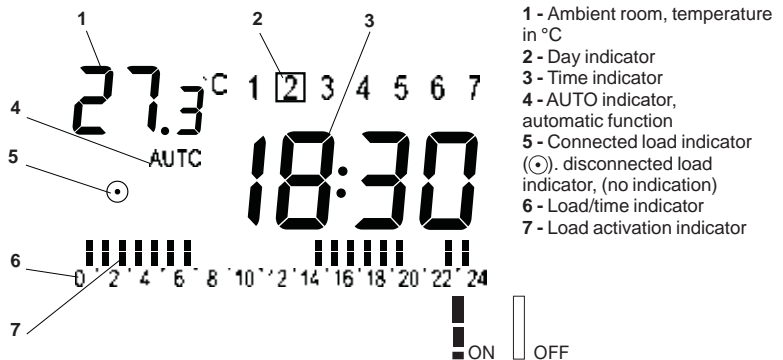

### Installation

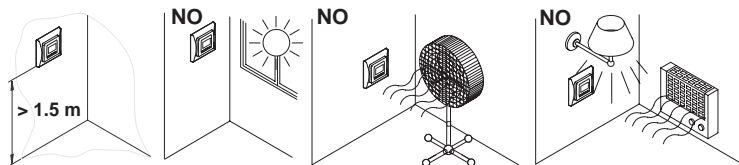

### Connections

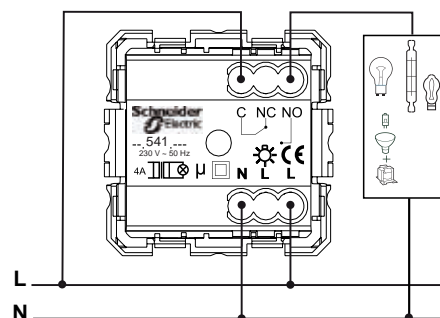

### Dimensions (mm)

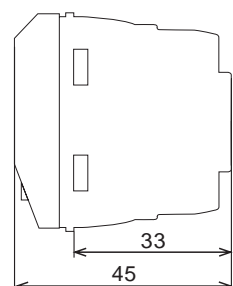

Connection terminals: screw connection for cables up to 2 x 1.5 mm<sup>2</sup>.



# Unica

## Technical information

### Time delay switches

#### MGU3.535.XX

### Area of application

- The weather station screen displays the time, temperature, humidity, atmospheric pressure, moon phase and the minimum and maximum temperatures for the last two weeks. It also has a function that forecasts the weather according to changes in atmospheric pressure. The weather forecasting function is 75 % reliable.
- The user can set the following parameters: either the screen changes sequentially every 15 s, or it remains unchanged.
- The user can switch off the weather station during a holiday period or period of absence.

### Technical data





- Rated voltage: 230 V AC ± 10 %, 50 Hz.
- Memory with no 230 V AC power supply: 7 days.
- Relative operating humidity displayed as a %: 20 to 90 %.
- Atmospheric pressure: 700- 1075 hPa/mb.
- Ambient room temperature display: 0 to 50 °C (tenths).
- Stabilisation time after connection to the mains: 6 h.
- Operating temperature: 0 to 50 °C.
- Storage temperature: -5 to 55 °C.
- Type of device to EN60669-2-1: type 1B.
- Software class: A.
- Device class: II.

### Standards

In accordance with EN 60669-2-1.

### Use

#### Keys

- MENU**  **Weather station menu/ On-Off**  
This menu is used to select the screen display mode which may be sequential or fixed. Press this button for more than 15 s to shut down the weather workstation.
-  **Increase values/ SELECT**  
This option is used to increase the displayed value during programming. Press the button for more than 5 s to open the Installer parameters menu.
- SELECT**  **Decrease values**
-  **Confirm values and actions**

#### Automatic mode screen

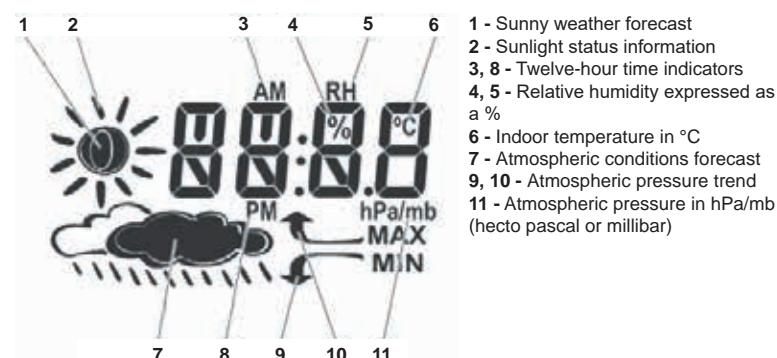

### Installation

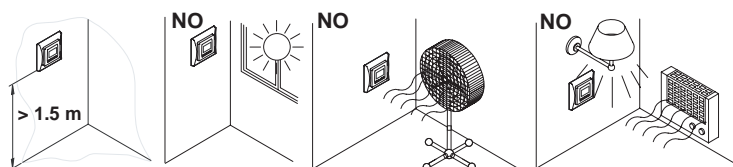

### Connections

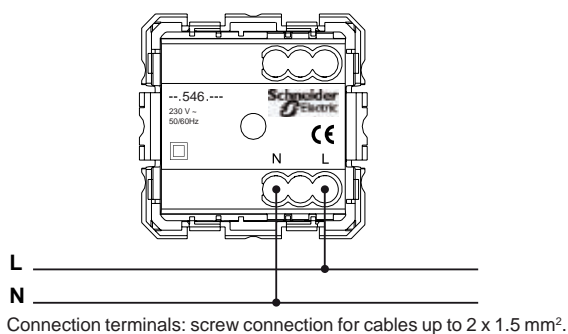

### Dimensions (mm)

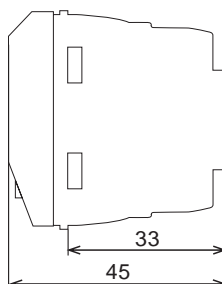

# Unica

## Technical information

### Wake up clocks

#### MGU3.545.XX

### Area of application

- The alarm clock screen displays the time, temperature and the alarms programmed during the day. The user can set 9 alarms for different times and different days.
- It is also possible to set the "Snooze" and alarm repeat functions for a specific number of minutes. The bell displayed on the screen (🔔) indicates that at least one alarm was set during the week.
- The "Date-Year" function is incorporated in the alarm clock. It allows the winter/summer changeover time to be set automatically.
- When the alarm is triggered, it can be stopped by pressing any key. If the "Snooze" function is set, the OK key stops the alarm permanently. Press one of the other buttons ("Menu", "▲" and "▼") to activate the alarm repeat function, which starts after the number of minutes set with the "Snooze" function have expired.

### Technical data

- Rated voltage: 230 V AC ± 10 %, 50 Hz.
- Number of programmable alarms: 9.
- Memory with no 230 V AC power supply: 7 days.
- Relative operating humidity displayed as a %: 20 to 85 %.
- Ambient room temperature display: 0 to 50 °C (tenths).
- Operating temperature: 0 to 50 °C.
- Storage temperature: -5 to 55 °C.
- Type of device to EN60669-2-1: 1B.
- Software class: A.
- Device class: II.

### Standards

In accordance with EN 60669-2-1.

### Use

#### Keys

**MENU**



#### Alarm clock menu / On-Off

This button is used to select the various possible states in turn. Press OK to access the various states. Press this button for more than 15 s to switch the alarm clock off.



#### Increase values / SELECT



This option is used to choose sequentially between switching the alarm on and off during programming.

**SELECT**



#### Decrease values



**OK**



#### Confirm values and actions

#### Automatic mode screen

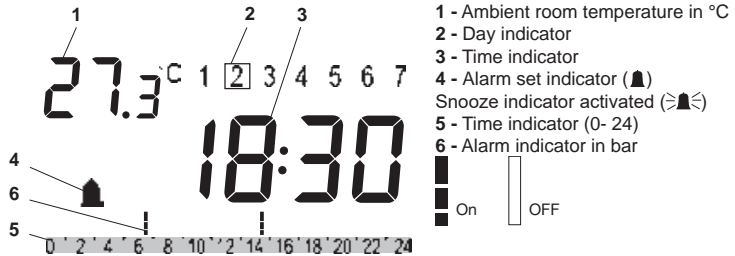

### Installation

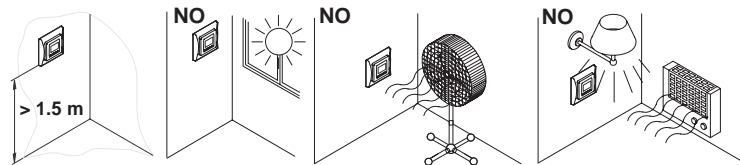

### Connections

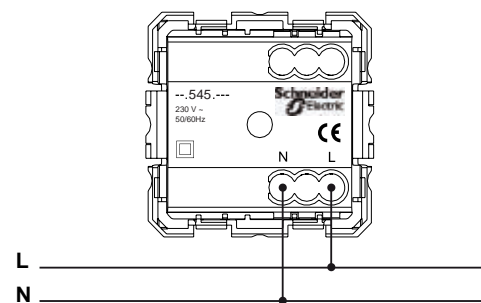

Connection terminals: screw connection for cables up to 2 x 1.5 mm<sup>2</sup>.

### Dimensions (mm)

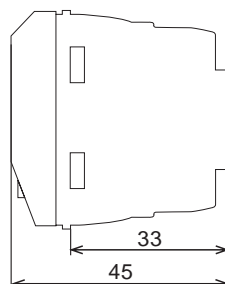

# Unica

## Technical information

### Key card switches

#### MGU3.540.XX (8 A timed) - MGU3.283.XX (10 A)

#### Area of application

- Particularly recommended for hotel rooms.
- Controls lighting circuits, electrical appliances, electronic equipment, etc.

#### Technical data

##### MGU3.540.XX (8 A timed)

- Power supply: 230 V AC ± 10 %, 50 Hz.
- Rated current: 8 A.
- A flashing LED indicates that the time-delay is off.
- The disconnect time can be any time between 10 s and 3 min.
- Type of card: 54 x 86 x 0.85 mm (max.), vertical insertion.
- With an amber night-time indicator lamp.
- Fuse: electronic.
- Protection: against overvoltages and thermal protection.
- Relay contact: free potential.

##### Load table (MGU3.540.XX only)

|                         |      |      |      |      |    |      |      |      |      |    |
|-------------------------|------|------|------|------|----|------|------|------|------|----|
|                         | 1    | 2    | 3    | 4    | 5  | 6    | 7    | 8    | 9    | 10 |
| 25 °C<br>230 V<br>50 Hz |      |      |      |      |    |      |      |      |      |    |
| Max. WVA                | 1470 | 1000 | 1470 | 1470 | NO | 1470 | 1470 | 1470 | 1470 | xx |

- 1 - Incandescent lamps or halogen lamps
- 2 - Low voltage halogen lamps with ferromagnetic transformer
- 3 - Low voltage halogen lamps with electronic transformers
- 4 - Fluorescent lamps with ferromagnetic ballast
- 5 - Fluorescent lamps with dimmable electronic ballast (1-10 V)
- 6 - Compact fluorescent lamps
- 7 - LED lamps
- 8 - Fan, motors (single-phase)
- 9 - Heaters (single-phase)
- 10 - Contactors

##### MGU3.283.XX (10 A)

- Power supply: 230 V AC ± 10 % 50 Hz.
- Rated current: 10 A.
- Type of card: 54 x 86 x 0.85 mm (max.), vertical insertion.
- With an amber night-time indicator lamp (ref. MGU.824).
- The supply is interrupted when the card is removed (45 to 54 mm wide).
- For fluorescent loads with a corrected power factor, the load should be controlled through an appropriate relay.

#### Standards

- MGU3.540.XX: in accordance with EN 60669-2-1.
- MGU3.283.XX: in accordance with EN 61058-1.

#### Installation (MGU3.540.XX)

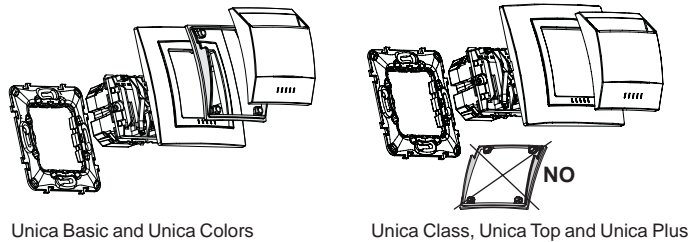

Unica Top, Unica Plus and Unica Allegro (Italian cover frames)

#### Use (MGU3.540.XX)

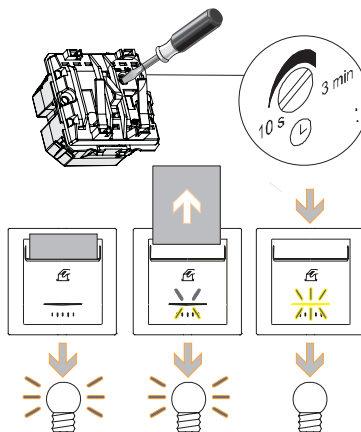

#### Installation (MGU3.283.XX)

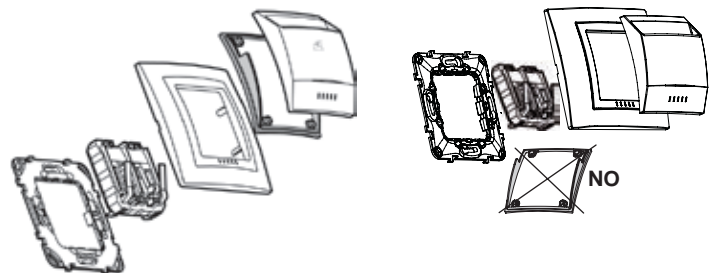

Unica Quadro, Unica Colors and Unica Basic

Unica Top, Unica Plus and Unica Allegro

#### Use (MGU3.283.XX)

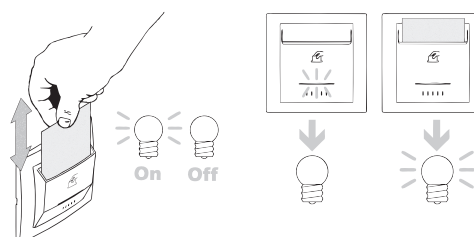

# Key card switches

## MGU3.540.XX (8 A timed) - MGU3.283.XX (10 A) (cont'd)

### Connections (MGU3.540.XX)

< 8 A

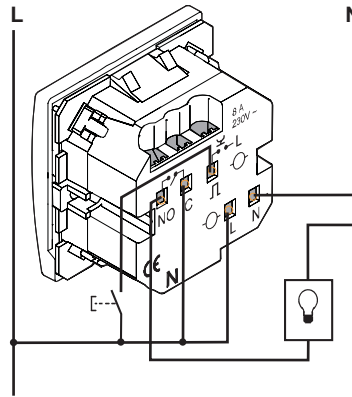

> 8 A

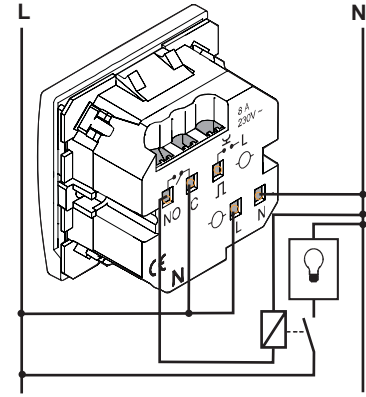

Connection terminals: screw connection for cables up to 2 x 2.5 mm<sup>2</sup>.

### Connections (MGU3.283.XX)

6 A max. (Faston)

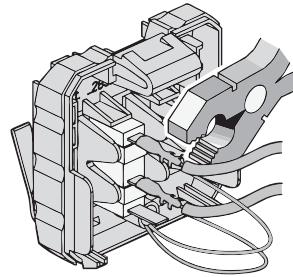

10 A (soldering)

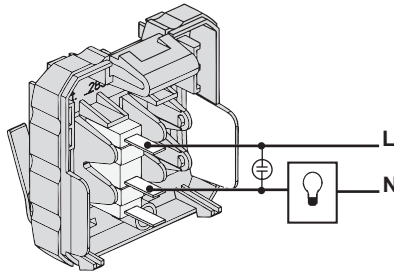
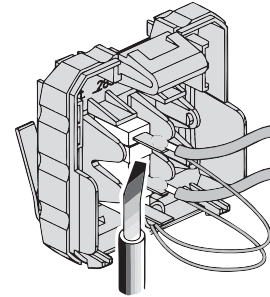

Connection terminals: Faston or soldering connection for cables up to 2.5 mm<sup>2</sup>.

### Dimensions (mm)

Unica Class, Unica Top, Unica Plus  
 and Unica Allegro

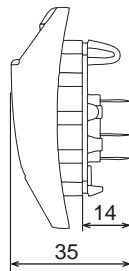

Unica Basic, Unica Colors  
 and Unica Quadro

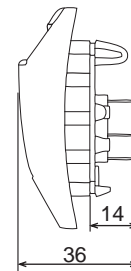

# Technical alarms

## MGU3.710.xx - MGU3.711.xx - MGU3.713.xx - MGU3.712

### Area of application

Two kinds of technical alarms are available to guard against potential danger for homes and building:

- Gas detectors: they are used to sound an alarm as soon as light gasses (natural gas, city gas, methane ...) or heavy gasses (butane, propane...) start to dissipate into the ambient air. Gas detectors are designed to be installed in boiler rooms and kitchen or other places where there is a risk of gas escapes.
- Flood detector: it is designed to detect a water leakage in order to prevent water damage. It is connected to SE3.712 sensor, located just a few centimeters off the floor.

### Technical data

#### Gas detectors

- Power supply: 12 V AC/DC.
- Signalling:
  - alarm indication: red LED,
  - power indication: green LED,
  - stabilization indication during switch on and malfunction indication: amber LED,
  - life time indication: label on front face.
- Test button on front face for simulation.
- Operating temperature: 5 to 40 °C.
- Operating consumption: 130 mA.
- Alarm level: 85 dB -1 m.
- Output contacts: potential free switch over contacts (NO, NC) for connecting solenoid valve on available voltage (12 V, 24 V or 127 V AC or 230 V AC).
- Installing recommendations:
  - 50 cm from the ceiling for methane gas detectors,
  - 50 cm from the floor for LPG gas detectors.

#### Flood detectors

- Power supply: 12 V AC/DC.
- Signalling:
  - alarm indication: red LED,
  - power indication: green LED,
- Test button on front face for simulation.
- Operating temperature: 5 to 40 °C.
- Operating consumption: 63 mA.
- Alarm level: 85 dB -1 m.
- Output contacts: potential free switch over contacts (NO, NC) for connecting solenoid valve on available voltage (12 V, 24 V or 127 V AC or 230 V AC).
- A flood sensor ( SEU.712) is delivered with each flood detector.

### Standards

- Quality marks: CE
- Standard: EN 50194.

### Use

- When the detectors are activated, an alarm is triggered, a red LED flashes and a powerful audible signal is given.
  - The detectors have potential free switch over contact, one NO and one NC to connect directly to a solenoid valve or siren.
  - The detectors are equipped with a test button on front face; they must be tested at regular intervals to ensure that they are operating correctly.
  - The gas detectors have a limited life time cycle of 5 years after the 1<sup>st</sup> installation.
- On the front cover a label has to be inserted to indicate the expire date of the gas detector.

### Connections

#### Gas detectors connection

127 or 230 V AC / 12 V AC power supply

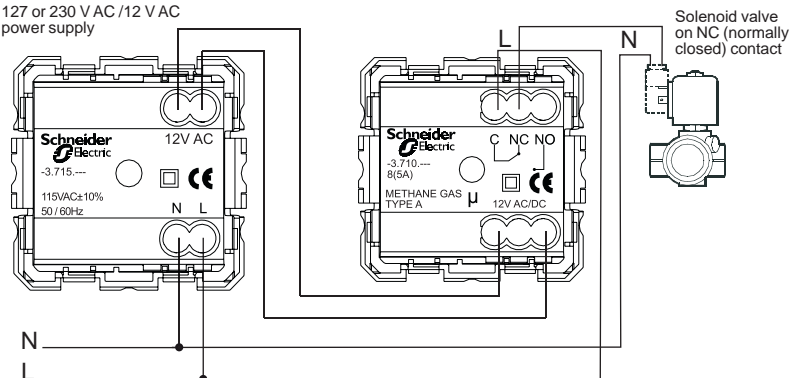

Connection terminals: screw connection for cables up to 2 x AWG16 (2 x 1.5 mm<sup>2</sup>).

#### Flood detector connection

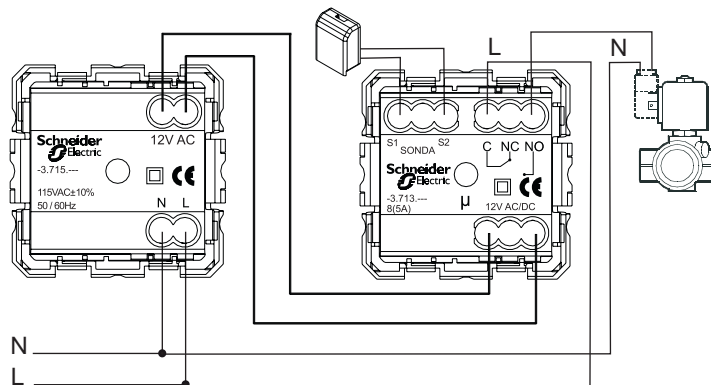

Connection terminals: screw connection for cables up to 2 x AWG16 (2 x 1.5 mm<sup>2</sup>).  
\*Use of a maximum of 3 sensors in parallel.

### Dimensions (mm)

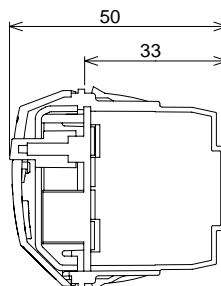

### Area of application

- Supply of household appliances, portable lighting devices, electronic devices, etc.
- Some power sockets include a child safety device.

### Technical data

- Insulation resistance: > 5 MΩ/ 500 V.
- Dielectric strength: > 2000 V.
- Minimum breaking capacity: 100 operations at 1.25 x I<sub>n</sub> and 1.1 x I<sub>n</sub>, where Pf (Cos φ) = 0.6.
- Enveloping and elastic cells.
- For operations, the earthing contact is made first and broken last.
- Minimum useful life: 10,000 position changes at I<sub>n</sub> and V<sub>n</sub>, where Pf (Cos φ) = 0.8.
- Materials: self-extinguishing technopolymer with excellent impact strength. The front parts are resistant to cleaning products and to UV radiation. They are halogen-free.
- The main sockets are also available in red to distinguish the circuits: identification of circuits supplied by uninterruptible power supply (UPS), AC networks or stabilised networks.

### Connections

- Screws or screwless connection:
  - screw connection by mixed head screw,
  - screwless connection without tool.
- Terminals accessible on a side part of the socket facilitating connection of terminals and insertion of the device in the box as the rear part remains free of cables.
- Terminals for cables up to 4 mm<sup>2</sup>, rigid or flexible.
- Screw connection by mixed head screw supplied loosened.

### Standards

In accordance with IEC 60884-1 and the following national standards depending on the country use: VDE 0620-1, UNE 20315-1-2, NFC 61-314, NOM-003-SCFI-2000, SI 32, BS 1363-1 and BS 546:1950.

### Installation

German or french, screw terminals socket-outlet

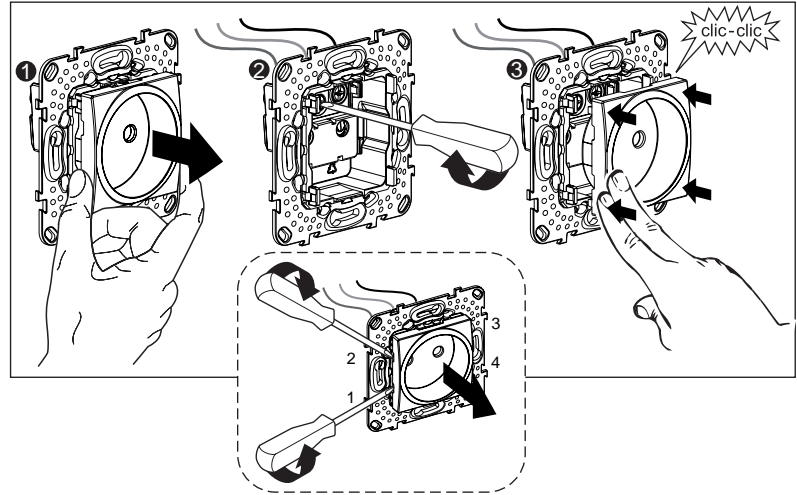

### Dimensions (mm)

10/16 A- 2P, German type

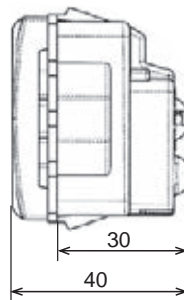

10/16 A- 2P, European type  
 10/16 A- 2P + E, French type

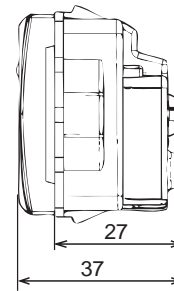

10 A- 2P, European type

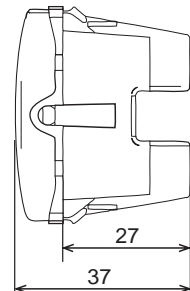

10/16 A- 2P, 2P + E,  
 Euroamerican, American  
 and Italian type

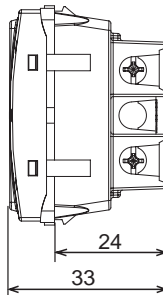

10 A- 2P + E, shuttered  
 British type

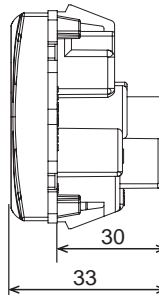

10/16 A- 2P + E, duplex,  
 American type

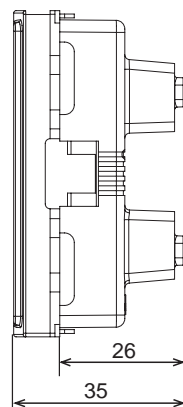

16 A- 2P, 2P + E, duplex  
 Euroamerican type

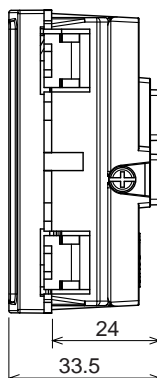

20 VA- 2P + E, shaver  
 socket

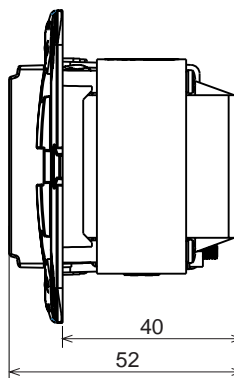

## Area of application

- Given the rapid evolution of the world of computing and telecommunications, today installation of networks is essential in offices and shops (and soon in homes) in order to share information and equipment (printers, scanners, etc.) between several computers.
- These networks consist of cables, connectors, centralising systems and other accessories that, installed in standard, flexible and upgradeable manner (for all Voice, Data, Image transmission applications), make up what is known as structured cabling system.
- The main component of structured cabling is the cable. There are different types of cable for data networks (coaxial, optical fibre, etc.), but the cable most commonly used is the twisted pair cable consisting of 2 insulated and interlaced copper wires.
- There are several types of twisted pair cables:
  - the U/UTP cable (Unshielded Twisted Pair) is a 4-pair twisted cable that is not shielded. It is intended for small and medium installations without electromagnetic pollution
  - the F/UTP cable (Foiled Twisted Pair) is a 4-pair twisted cable with general shielding for external protection, common to all 4 pairs, protecting them against reduced electromagnetic pollution. It is suitable for installations requiring minimum electromagnetic protection
  - the S/FTP cable (Shielded Twisted Pair) is also another 4-pair shielded twisted cable with protective shielding of each pair against high electromagnetic pollution. This minimises emissions. It is suitable for installations requiring a high level of electromagnetic protection.
- The RJ45 socket is an 8-pin connector standardised by ISO8877 for connection of devices to VDI networks.
- One of the standards most commonly used for production of structured cabling is that of the North American Association of electronic and telecommunications manufacturers (EIA/TIA 568B) that has defined a colour code with 2 alternatives, to describe connection of the RJ45 connector.

## Technical data

### Categories

- The most important property defining a data network is the speed at which information can circulate inside this network.
- According to this aspect, installations are classed into the following categories:

| Category            | Transmission rate | Network type                          |
|---------------------|-------------------|---------------------------------------|
| Cat. 3              | Up to 10 MHz      | Ethernet 10 Base T, Token Ring 4 Mbps |
| Cat. 4              | Up to 16 MHz      | Token Ring 16 Mbps                    |
| Cat. 5e             | Up to 100 MHz     | Ethernet 1000 Base T, ATM 155 Mbps    |
| Cat. 6              | Up to 250 MHz     | Ethernet 1000 Base T, ATM 1200        |
| Cat. 6 <sub>A</sub> | Up to 500 MHz     | Ethernet full-duplex mode 1000 Base T |

- So that an installation can be included in a certain category, all the elements making it up must belong to the same category, or, otherwise, it will be classed in the category of the lower category element.

### Unica offer

- The Unica offer consists of supports for RJ45 connectors and of a broad and comprehensive range of RJ45 infraplus and LexCom connectors covering virtually all structured cabling needs, both current and future.
- This offer satisfies the technical requirements of prevailing regulations soon to be standardised and stand out by the following characteristics:
  - ease of mounting: each connector is equipped with a code of colours and numbers to guide connection at all times without needing special tools
  - high connector quality with category 6 and 6 sockets thus allowing us to propose the quickest connector on the market
  - minimum conductor untwisting for connection, thus preventing electromagnetic interference
  - connection reliability
  - compact size (particularly for the shielded version).

## Connections

### Telephone connection

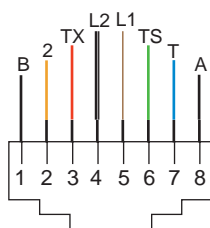

### EIA/TIA 568B

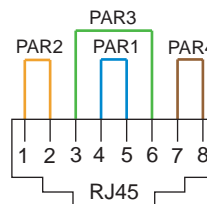

## Dimensions (mm)

### RJ45 cover

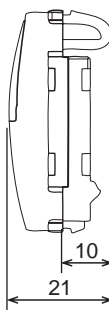

### RJ45 socket

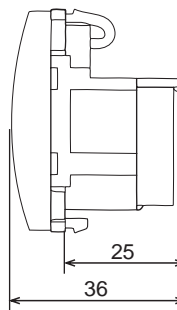

### Compatibility table for RJ45 cover plates

#### AMP®

| Connector ref. | Type |        | Compatibility with MGU9.460.XX universal cover | Compatibility with MGU9.461.XX universal cover |   |
|----------------|------|--------|--|--|---|
| 1375055-x      | UTP  | Cat. 6 | •  | •  |   |
| 1375188-1      | STP  |        | •  | •  |   |
| 406372-x       | UTP  | Cat. 5 | •  |  |   |
| 1375191-x      |      |        | •  | •  |   |
| 1116604-x      |      |        | •  | •  |   |
| 1479139-x      |      |        | •  |  |   |
| 1116515-1      |      |        | STP  | •  |   |
| 1375189-1      |      |        |  | •  | • |
| 1339015-1      | •    | •      |  |  |   |
| 1479140-1      | •    |        |  |  |   |
| 406373-2       | UTP  | Cat. 3 | •  |  |   |

#### SYSTIMAX®

| Connector ref. | Type |        | Compatibility with MGU9.460.XX universal cover | Compatibility with MGU9.461.XX universal cover |
|----------------|------|--------|--|--|
| MGS400-xxx     | UTP  | Cat. 6 | •  | •  |
| MPS100E-xxx    |      | Cat. 5 | •  | •  |

#### BRAND REX®

| Connector ref.   | Type |        | Compatibility with MGU9.460.XX universal cover | Compatibility with MGU9.461.XX universal cover |
|------------------|------|--------|--|--|
| C6C-JAK-U-01-2   | UTP  | Cat. 6 | •  | •  |
| C6C-JAK-U-01-3   |      |        | •  | •  |
| C6C-JAK-F-OK-2   | FTP  |        | •  | •  |
| C6C-JAK-F-AK-2   |      |        | •  |  |
| C6C-JAK-F-BK-2   |      |        | •  |  |
| GPC-JAK-U-B1-3   | UTP  | Cat. 5 | •  | •  |
| GPC-JAK-U-A1-3   |      |        | •  | •  |
| GPC-JAK-U-BK-3   |      |        | •  | •  |
| GPC-JAK-U-AK-3   |      |        | •  | •  |
| GPC-JAK-U-01-3LF |      |        | •  | •  |
| GPC-JAK-F-01-2LF |      |        | FTP  |  |
| GPC-JAK-F-B1-2   | •    |        |  |  |
| GPC-JAK-F-A1-3   | •    |        |  |  |
| GPC-JAK-F-BK-2   | •    |        |  |  |
| GPC-JAK-F-AK3    | •    |        |  |  |



Unica  
 Technical information  
**RJ45 data sockets (cont'd)**

**Compatibility table** (Cont'd)

**GENERAL CABLE®**

| Connector ref. | Type |        | Compatibility with MGU9.460.XX universal cover | Compatibility with MGU9.461.XX universal cover |
|----------------|------|--------|--|--|
| CU6PJACBLP     | UTP  | Cat. 6 | •  |  |
| CU6PJAKBLP     |      |        | •  | •  |
| CU5EJACBLP     | UTP  | Cat. 5 | •  |  |
| CU5EJAKBLP     |      |        | •  | •  |
| CU5PJACBLP     |      |        | •  | •  |
| CF5NJAC99P     |      |        | FTP  | •  |
| CF5PJAC99P     | •    |        |  |  |

**KRONE®**

| Connector ref. | Type |        | Compatibility with MGU9.460.XX universal cover | Compatibility with MGU9.461.XX universal cover |
|----------------|------|--------|--|--|
| 6380 1 800-04  | UTP  | Cat. 6 | •  | •  |
| 6380 1 810-04  |      |        | •  |  |
| 6830 1 305-01  |      |        | •  | •  |
| 6830 1 312-xx  |      |        | •  |  |
| 6540 1 100-07  | UTP  | Cat. 5 | •  | •  |
| 6540 2 161-60  |      |        | •  |  |
| 6540 1 130-xx  |      |        | •  | •  |
| 6540 1 154-02  |      |        | •  |  |
| 6467 1 081-xx  |      |        | •  | •  |

**NEXANS®**

| Connector ref. | Type |        | Compatibility with MGU9.460.XX universal cover | Compatibility with MGU9.461.XX universal cover |
|----------------|------|--------|--|--|
| N420.610       | UTP  | Cat. 6 | •  | •  |
| N420.620       |      |        | •  | •  |
| N420.630       |      |        | •  | •  |
| N420.510       | UTP  | Cat. 5 | •  | •  |
| N420.520       |      |        | •  | •  |
| N420.530       |      |        | •  | •  |
| N420.416       |      |        | •  | •  |
| N420.426       |      |        | •  | •  |

Note: Use 429.620 article with this type of connectors.

**NORDX/CDT®**

| Connector ref.     | Type |        | Compatibility with MGU9.460.XX universal cover | Compatibility with MGU9.461.XX universal cover |
|--------------------|------|--------|--|--|
| AX101318 to 101328 | UTP  | Cat. 6 | •  | •  |
| AX101307 to 101317 |      | Cat. 5 | •  | •  |
| AX100577 to 100587 |      | •      | •  |  |

**SUPERIOR®**

| Connector ref. | Type |        | Compatibility with MGU9.460.XX universal cover |
|----------------|------|--------|--|
| KMJSIXB02      | UTP  | Cat. 6 | •  |
| KMJVL8A/B02S   | FTP  | Cat. 5 | •  |
| KMJVL8A/B02    |      |        | •  |
| KMJJFS8B02     | UTP  | Cat. 5 | •  |

# Unica Technical information RJ45 data sockets (cont'd)

## Installation

Example of unshielded data socket installation (cat 6A, 5, 5e)

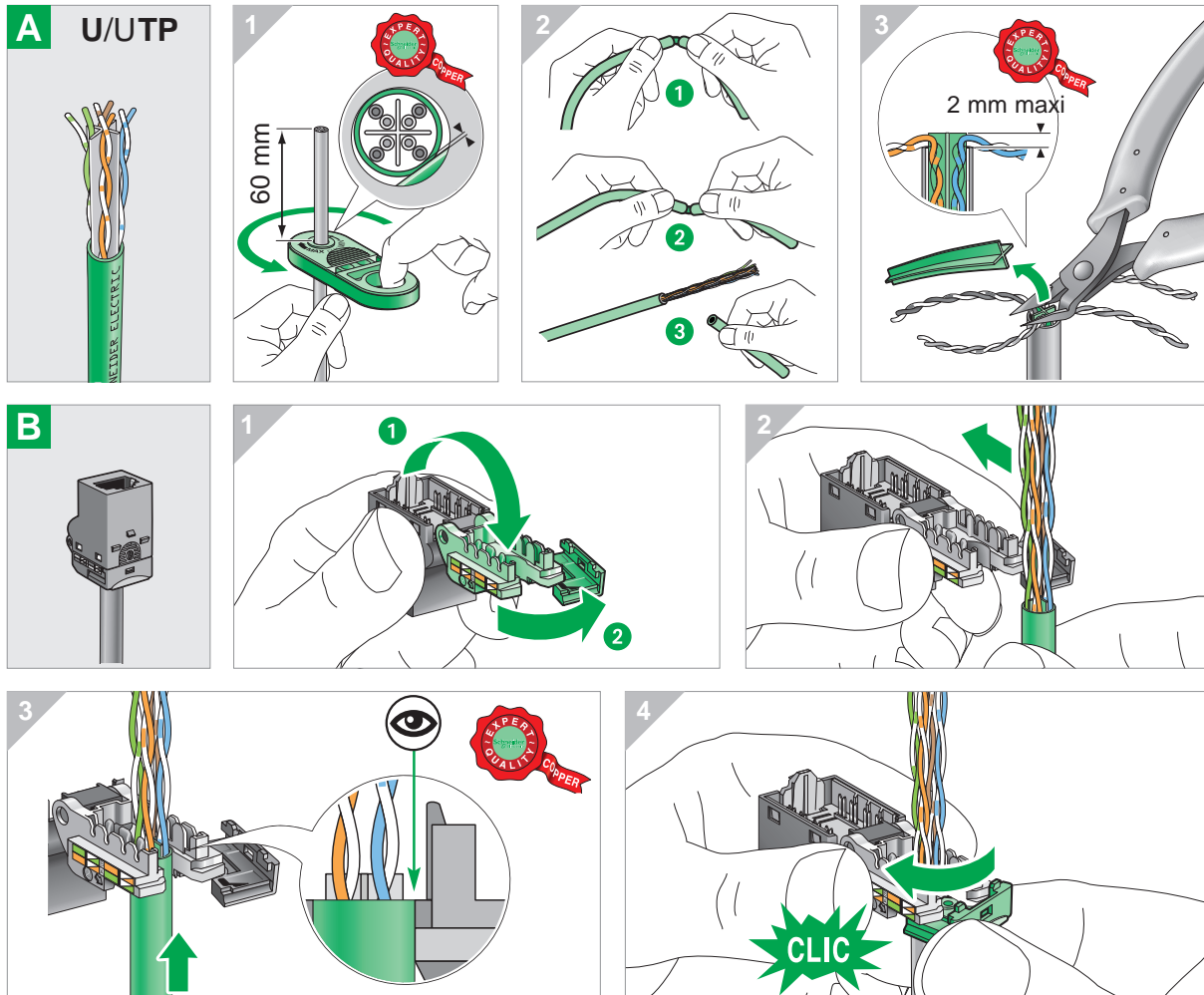

# Unica

## Technical information

### RJ45 data sockets (cont'd)

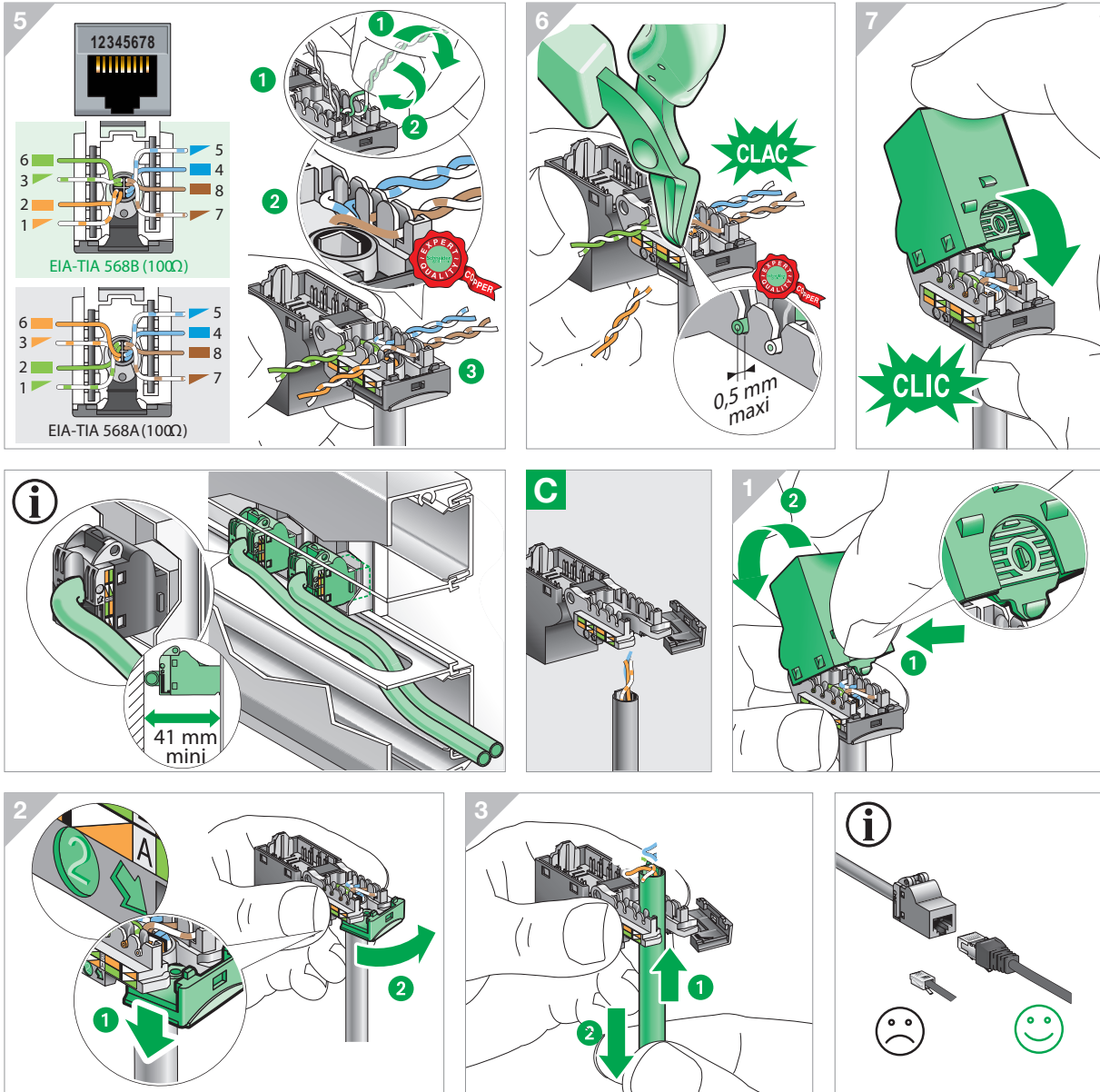

# Unica Technical information RJ45 data sockets (cont'd)

## Installation

Example of shielded data socket installation (cat 6A, 5, 5e)

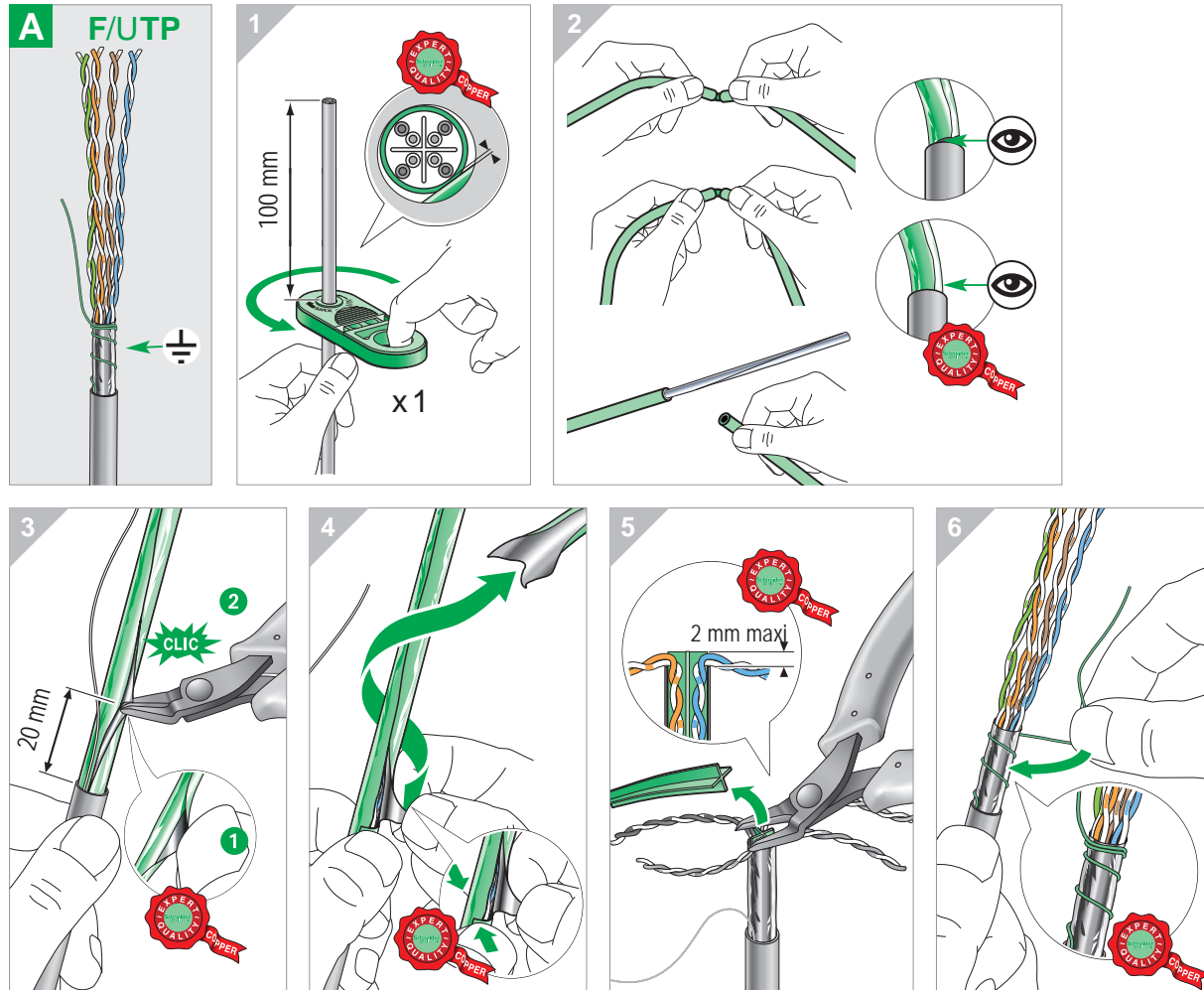

# Unica

## Technical information

### RJ45 data sockets (cont'd)

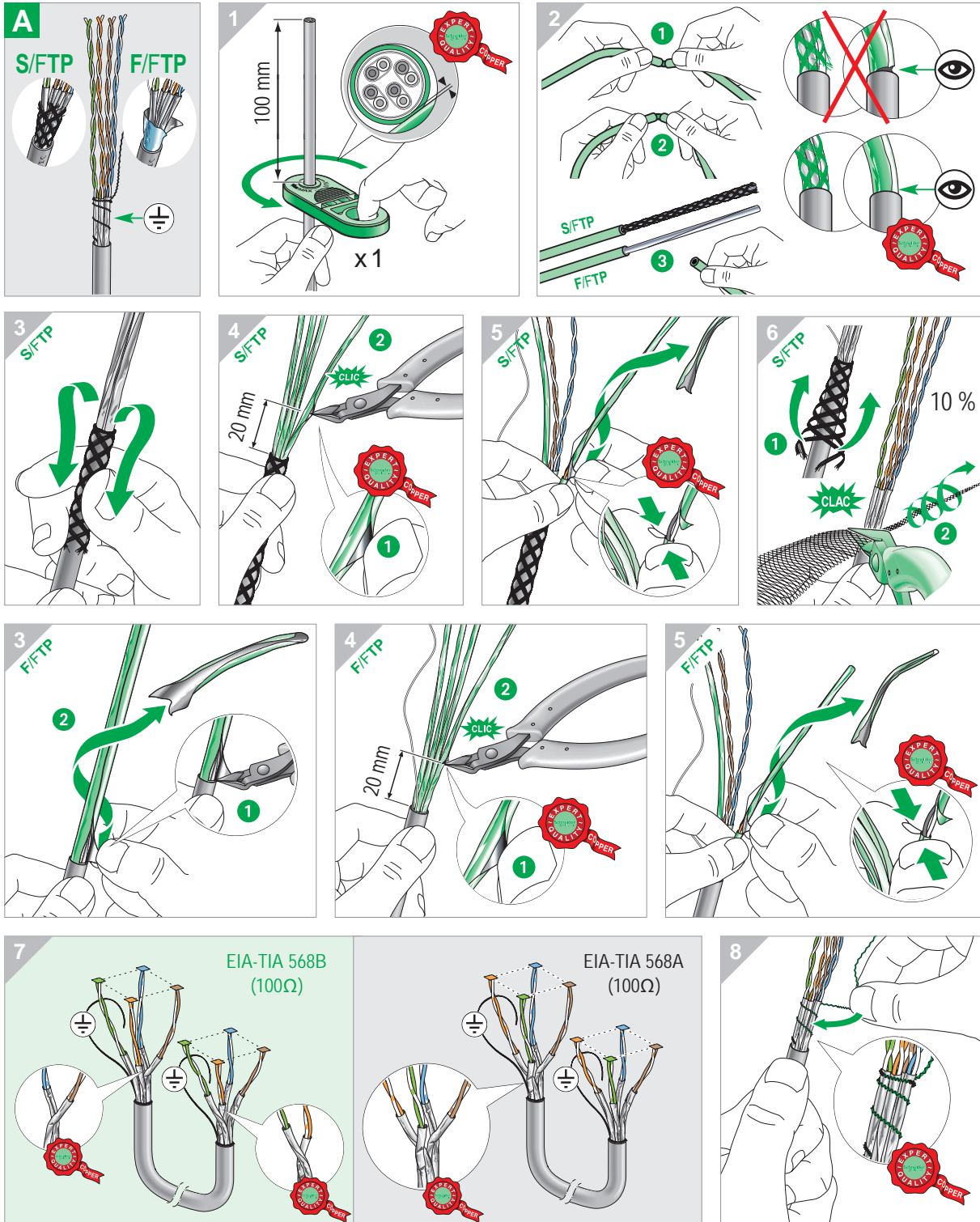

# Unica Technical information RJ45 data sockets (cont'd)

## Installation

Example of shielded data socket installation (cat 6A, 5, 5e) (Cont'd)

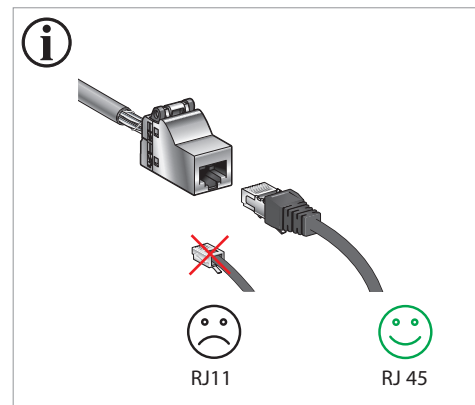
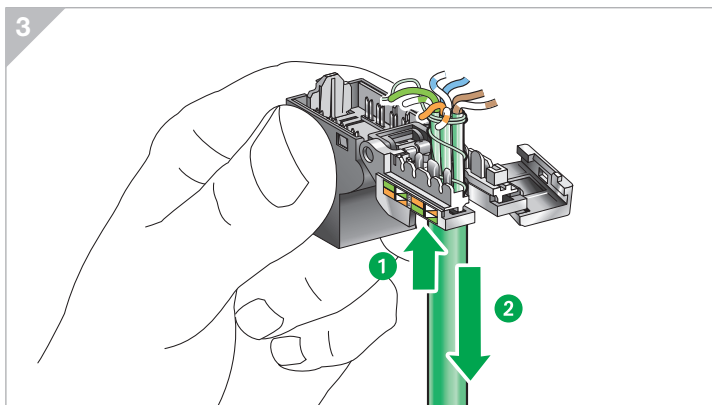
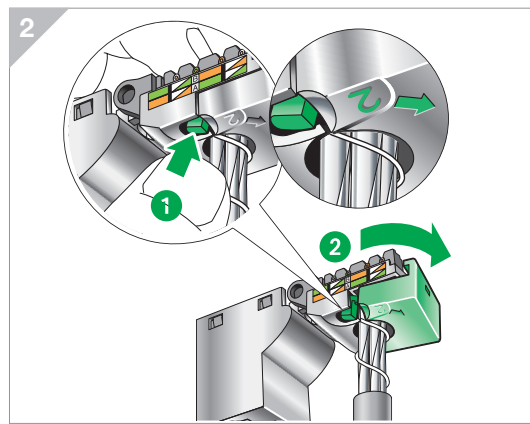
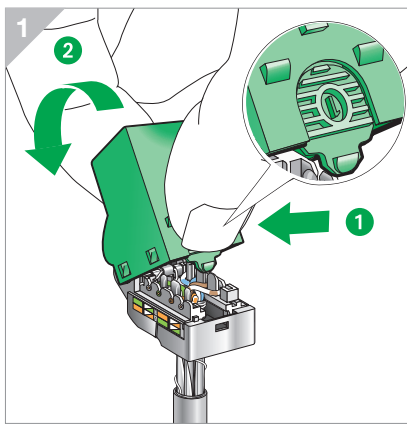
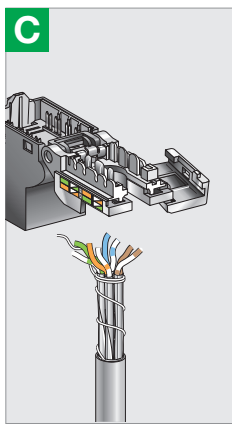
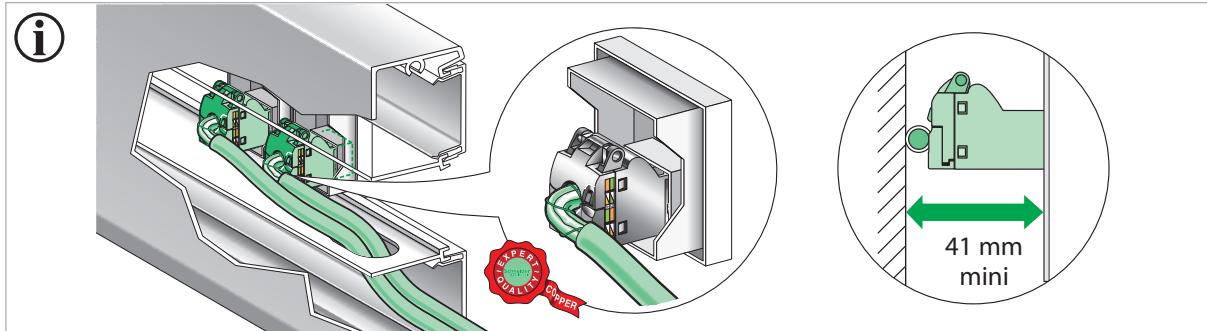

Unica  
 Technical information  
 RJ45 data sockets (cont'd)

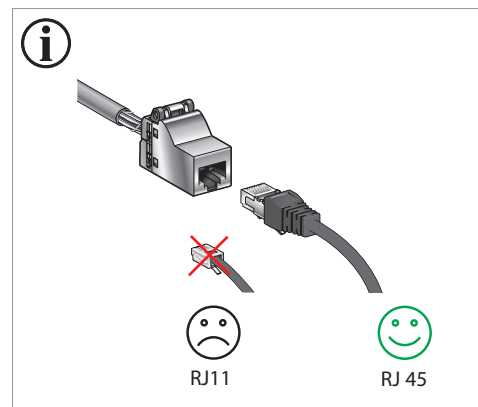
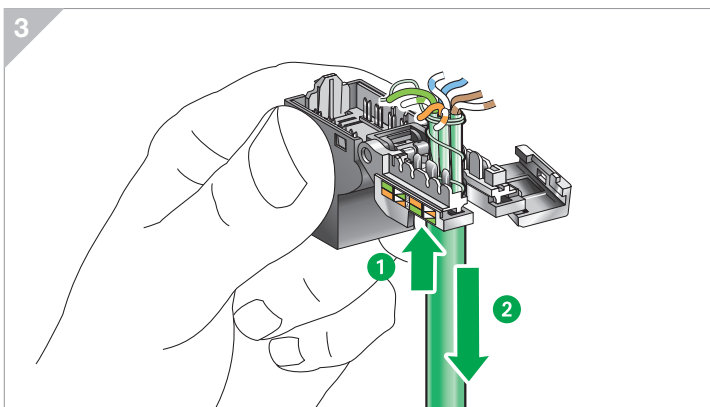
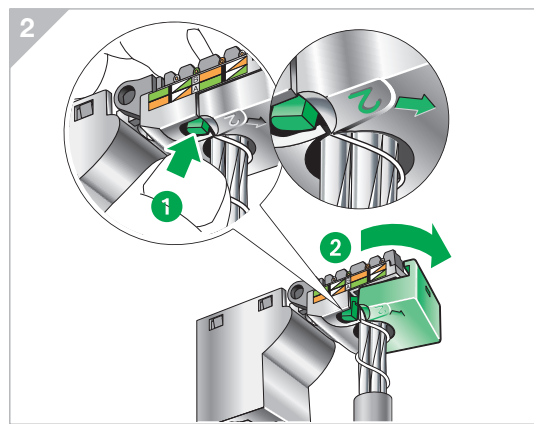
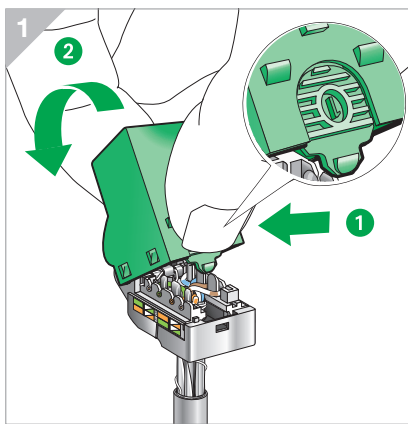
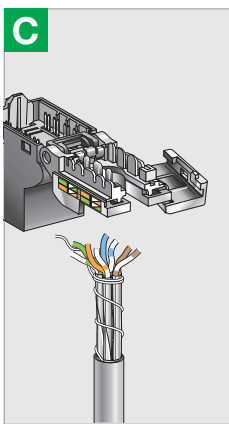
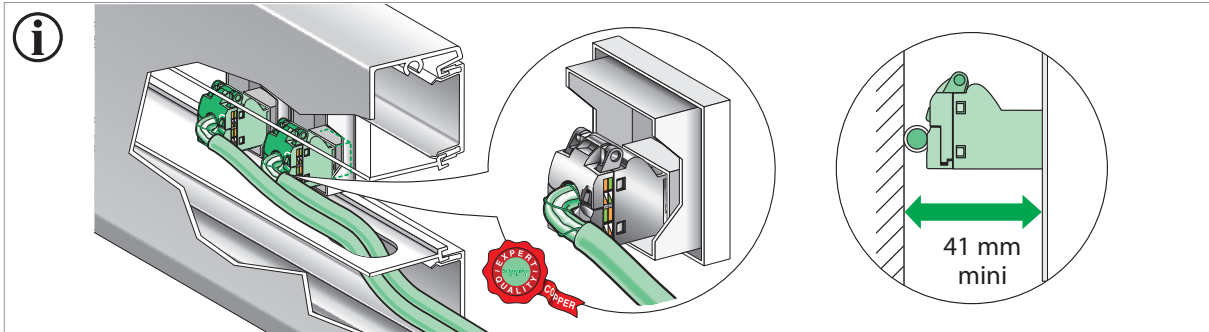

## Area of application

Antenna sockets are adapted for connection of radio and television receivers, with land-based or satellite-based analog and digital signals, by cable over a frequency band of between:

- 47 and 860 MHz for those of TV/FM type,
- 10 and 2300 MHz for R-TV/SAT type,
- 5 and 2400 MHz for R/TV/SAT ones.

## Technical data

- For sockets with a double output, signals arriving mixed via the cable from the antenna are separated and transmitted by 2 IEC Ø 9.5 mm type connectors, one male and the other female.
- For TV/ FM sockets, the male connector delivers the frequency band from 47 to 860 MHz for land television and the female connector from 87 to 108 MHz to receive radio transmissions.
- For R-TV/ SAT sockets, the male connector delivers frequencies from 10 to 830 MHz for radio and land television and the female connector reproduces the bandwidth between 950 and 2400 MHz to receive television transmissions via satellite.
- For R/TV/ SAT sockets, the male connector delivers the frequency band from 47 to 860 MHz for land television, the female connector from 87 to 108 MHz to receive radio transmissions and the F connector reproduces the bandwidth between 950 and 2400 MHz to receive television transmissions via satellite.
- Functionally speaking, the sockets are designed so that the mechanical part can facilitate and ensure suitable connection of coaxial cables. The socket body is entirely made of Zamak cast iron (Zamak is a zinc and aluminium alloy) so as to offer perfect shielding (against electromagnetic interference) to the electronic part that is made up of passive components (not requiring power supply), able to obtain the best adaptation characteristics as regards impedance, attenuation and decoupling, thus ensuring optimum level audio and video signals over the entire installation.
- The R-TV/ SAT sockets satisfy all the requirements of the new regulations on Common Telecommunications Infrastructures (CTI) as per R.D. 1/1998 and R.D. 279/1999.

## Standards

In accordance with:  
EN 50083-1, EN 50083-2 and EN 50083-4.

### TV-FM sockets

|                               |                       | MGU3.451.XX       | MGU3.452.XX        | MGU3.453.XX         | MGU3.458.XX            | MGU3.459.XX             |
|-------------------------------|-----------------------|-------------------|--------------------|---------------------|------------------------|-------------------------|
| Frequencies                   |                       | Individual        | End-of-line series | Intermediate series | End-of-line low losses | Intermediate low losses |
| Pass through attenuation (db) | R<br>87.5-108 MHz     | 10                | 27                 | 32                  | 32.5                   | 27.5                    |
|                               | TV/VHF<br>47-68 MHz   | 2                 | 13.5               | 17                  | 5                      | 12                      |
|                               | TV/UHF<br>125-860 MHz | < 1               | 13.5               | 17                  | 5                      | 10.3                    |
| Outlet attenuation (db)       | TV                    |                   |                    | 0.5                 |                        | < 1                     |
| DC current                    |                       | no                | yes                | yes                 | no                     | yes                     |
| Sockets/line                  |                       | 1                 | 1                  | 7                   | 1                      | 4                       |
| Connectors                    |                       | IEC Ø 9.5 mm type |                    |                     |                        |                         |

### R-TV-SAT sockets

|                               |                       | MGU3.454.XX       | MGU3.455.XX        | MGU3.456.XX         |
|-------------------------------|-----------------------|-------------------|--------------------|---------------------|
| Frequencies                   |                       | Individual        | End-of-line series | Intermediate series |
| Pass through attenuation (db) | R<br>10-108 MHz       | < 0.8             | < 9                | 13                  |
|                               | TV/VHF<br>118-470 MHz |                   |                    |                     |
|                               | TV/UHF<br>470-830 MHz | < 1.4             | < 17               | < 12                |
| Outlet attenuation (db)       | TV                    |                   |                    | 1                   |
|                               | SAT                   |                   |                    | 1.5                 |
| DC current                    |                       | In SAT socket     |                    |                     |
| Sockets/line                  |                       | 1                 | 1                  | 4                   |
| Connectors                    |                       | IEC Ø 9.5 mm type |                    |                     |

### R/TV/SAT sockets

|                               |                     | MGU3.450.XX       |
|-------------------------------|---------------------|-------------------|
| Frequencies                   |                     | Individual        |
| Pass through attenuation (db) | R<br>5-108 MHz      | ≤ 3               |
|                               | TV<br>125-862 MHz   | ≤ 2.5             |
|                               | SAT<br>950-2400 MHz | ≤ 3               |
|                               |                     |                   |
| DC current                    |                     | In SAT socket     |
| Sockets/line                  |                     | 1                 |
| Connectors                    |                     | IEC Ø 9.5 mm type |

### SAT single shielded sockets

|                          |  | MGU3.462.XX       | MGU3.463.XX       | MGU3.464.XX |
|--------------------------|--|-------------------|-------------------|-------------|
|                          |  | Individual        | Passage           | Terminal    |
| Frequency (MHz)          |  | 5-2150            |                   |             |
| Shunt attenuation (dB)   |  | 11                | 11                | 8           |
| Passage attenuation (dB) |  | -                 | < 1<br>(2150 MHz) | -           |
| Current passage          |  | NO                |                   |             |
| Sockets/line             |  | 1                 | 4                 | 1           |
| Connector                |  | IEC Ø 9.5 mm male |                   |             |

### TV single shielded sockets

|                          |  | MGU3.465.XX         | MGU3.466.XX        | MGU3.467.XX |
|--------------------------|--|---------------------|--------------------|-------------|
|                          |  | Individual          | Passage            | Terminal    |
| Frequency (MHz)          |  | 5-862               |                    |             |
| Shunt attenuation (dB)   |  | 11                  | 11                 | 8           |
| Passage attenuation (dB) |  | -                   | < 0,5<br>(562 MHz) | -           |
| Current passage          |  | NO                  |                    |             |
| Sockets/line             |  | 1                   | 4                  | 1           |
| Connector                |  | IEC Ø 9.5 mm female |                    |             |



#### Cover frame installation

Covers ref. MGU9.440.XX and MGU9.441.XX are used to apply **Unica** finishing to standard TV sockets (such as those of TELEVES, IKUSI, etc.). The rack type guides must be separated from the cover frame to be installed, as shown on the following drawing..

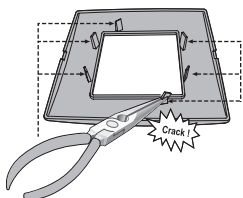

#### Connections

- Prepare the coaxial cable according to the dimensions specified on the following drawing.
- Ensure that no external mesh wires touch the central wire (live).



- Lift up the central cover of the socket and place the cable or cables as per the following photo: when installing the 2 cables (on the Intermediate Series sockets), check that the cable properly matches the position given by the arrows on the "signal input" and "signal output" socket.
- Fold back the cover and fully screw on.

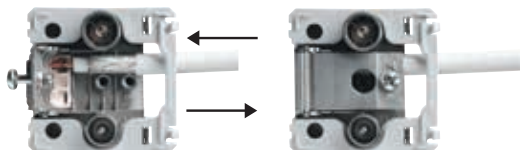

TV socket

Cover

#### Dimensions (mm)

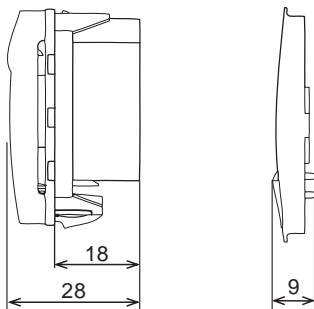

#### Installation

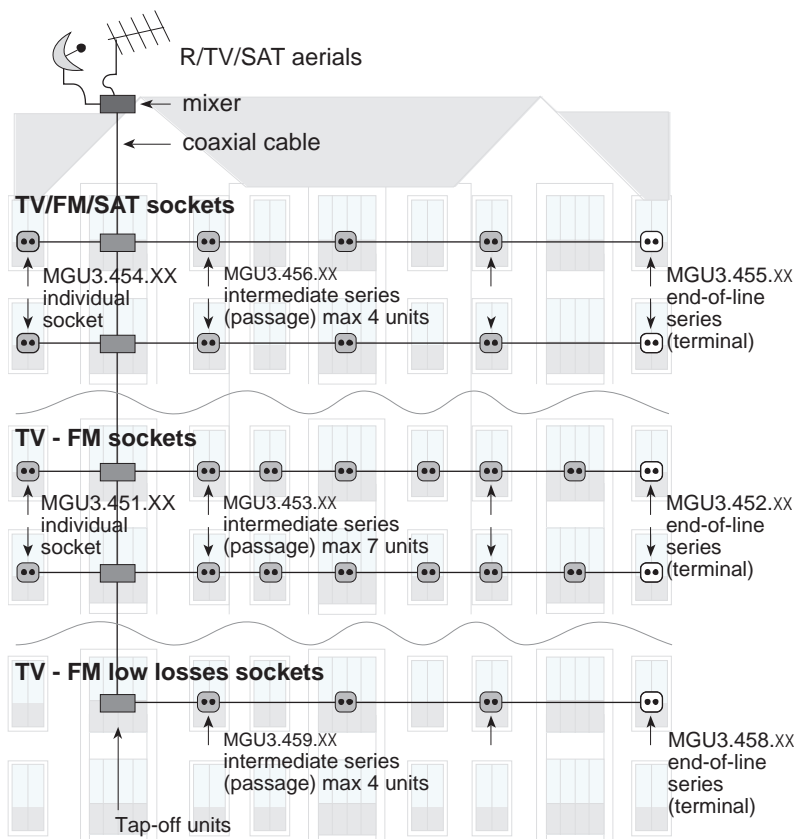

### Area of application

USB chargers allow you to quickly charge the battery of a portable device without a mobile charger

### Use

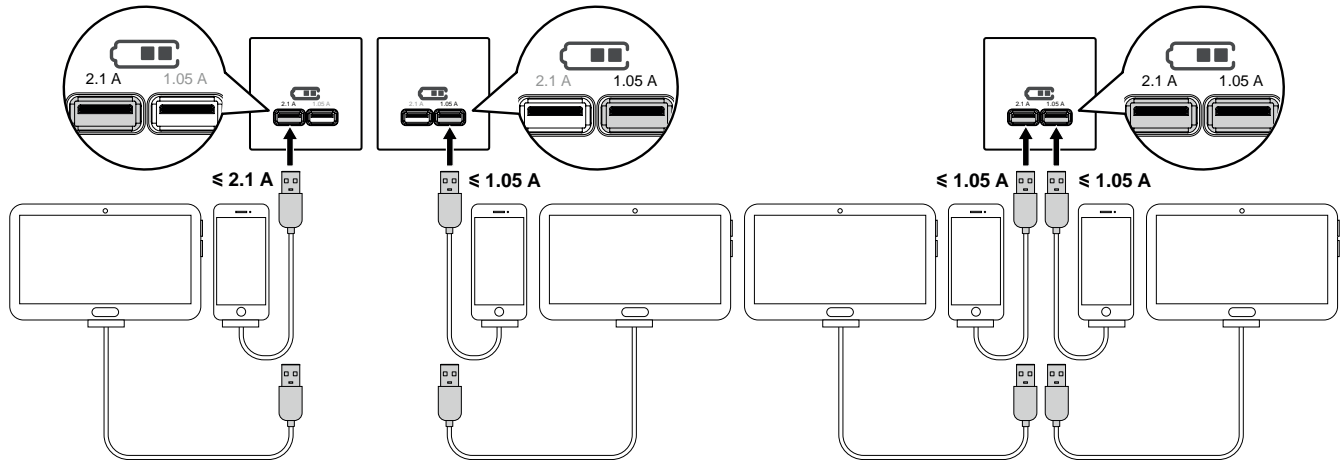

### Connection

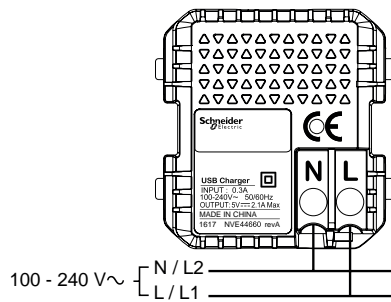

### Embedding depth

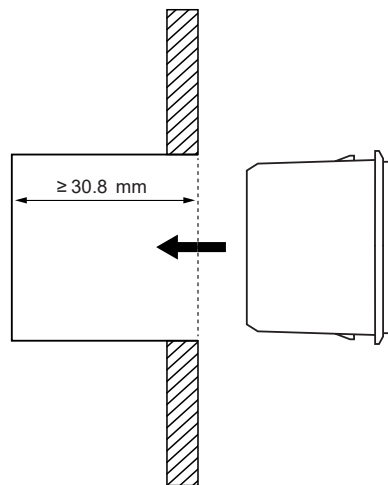

# Unica

## Technical information

### In-wall bluetooth audio receivers

#### Area of application

- The audio receiver can be paired with any bluetooth device
- Play Music:
  - Stored in the phone / computer / tablet
  - From a Internet Radio
  - From any Music platform
- Ideal for hotel and hospital rooms, educational centers, business purposes, home
- Each module has its own identification number to avoid interference from other users nearby
- It can be also connected to any device without bluetooth using the AUDIO IN option
- It can be connected to two or more speakers of any model, type and brand available in the market.

#### Characteristics

##### Audio receiver:

- communication network type: bluetooth
- operating distance: 10 m
- connector type: jack 3.5 mm
- input impedance: 62  $\Omega$
- rated operational voltage: 15-16 V DC
- current consumption: 4.5-100 mA
- signal isolation: 58 dB
- bandwidth: 45-20 000 Hz
- signal to noise ratio: 84 dB
- number of addresses: 0000-9999
- transmission frequency: 2.4 GHz
- radio power: 7 dBm
- connection terminals: screws terminals
- degree of protection: IP20

##### Power supply:

- rated operational voltage: 265 V AC
- network frequency: 47-63 Hz
- consumption demand: 12 W
- input voltage: 100 mV rms with jack
- output voltage: 15 V DC
- output current: 800 mA
- nominal output power:
  - 2.5 W, 0.8 A, 15 VDC, 8  $\Omega$
  - 1.5 W, 0.8 A, 15 VDC, 16  $\Omega$
- connection terminals: screws terminals
- degree of protection: IP20

##### Loudspeakers:

- 2 loudspeakers delivered with 2 cables (5 m,  $\Phi$  0.5 mm<sup>2</sup>, red and white)
- dimensions (diameter x depth): 95 mm x 36 mm
- input impedance: 8  $\Omega$

#### Connections

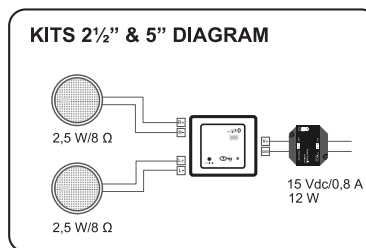
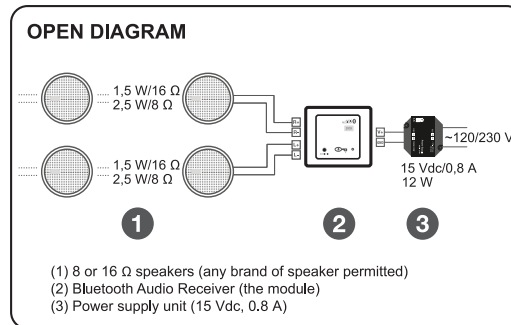

#### Embedding depth

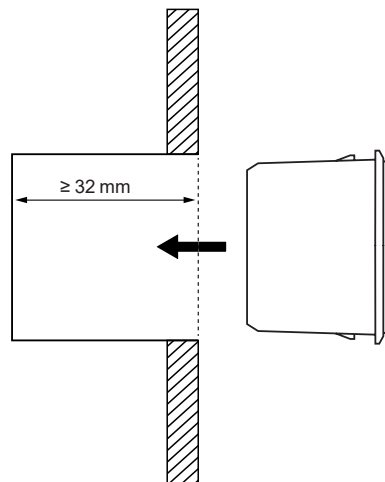

# In-wall bluetooth audio receivers (cont'd)

## Use

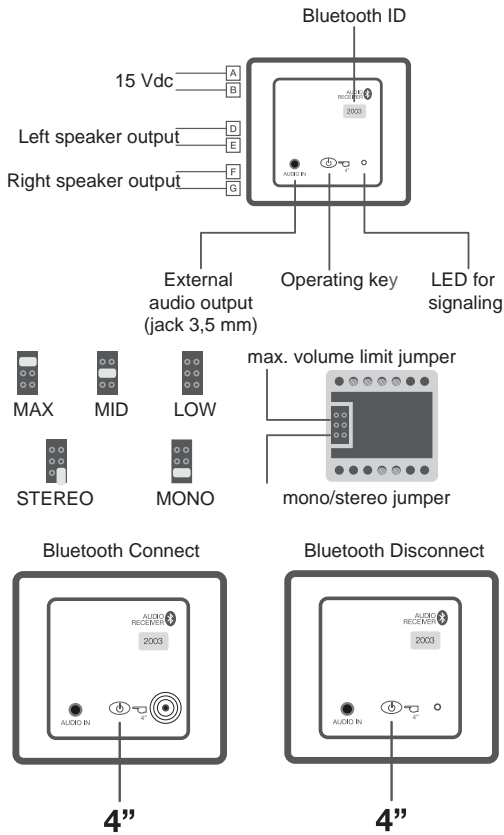

### LED for signaling

The LED color for signaling the status of the Module is as follows:

- Blue flashing LED = waiting for pairing and connecting with the bluetooth device
- Blue LED = module is connected to the bluetooth device
- Red LED = an external audio input has been inserted

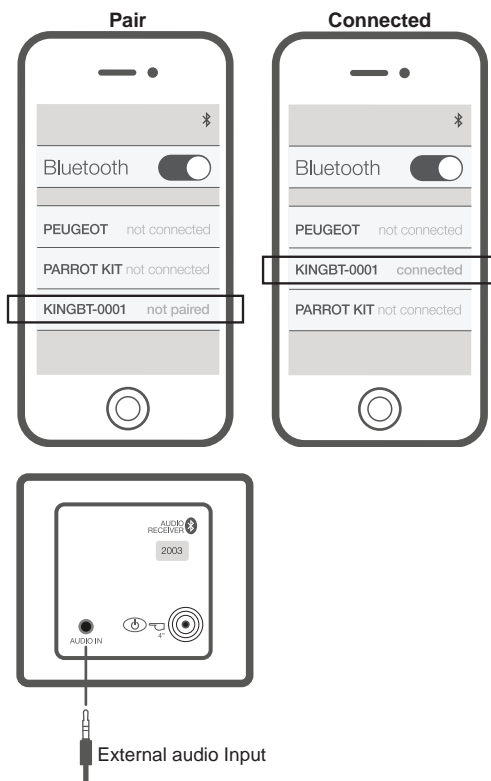

#### Area of application

- To connect telephone sets, modems, fax machines and other telephony equipment to the network.
- The 6-pin socket is suitable for new design installations, as it is adapted to current regulations on Common Telecommunications Infrastructures (CTI), which indicate that the Terminal Access Database (TAD) must be equipped with a 6-channel Bell type female connector.

#### Technical data

- 4 to 6-pin connectors (RJ11 and RJ12 respectively) with screw connection or insulator displacement.
- These connectors are Category 3, implying transmission rates of up to 16 Mb/s.
- The standard line with 1 pair of wires is connected between L1 and L2 connection of RDSI, ADSL lines and other 4-wire lines (two pairs) is found between L1-L2 and TX-TS.

#### Connection

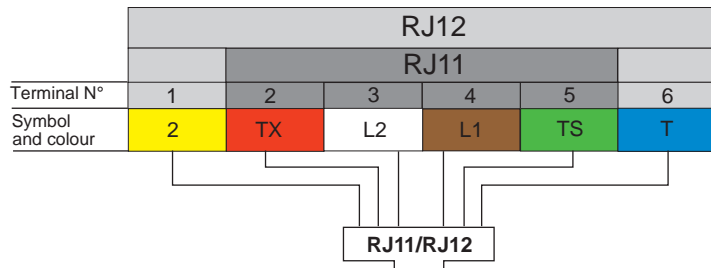

#### Screw connection system

Connection terminals: screw connection for rigid cables up to 0.2 mm<sup>2</sup>.

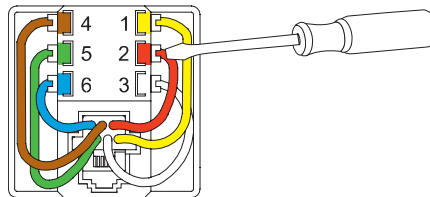

#### Connection system by insulator displacement

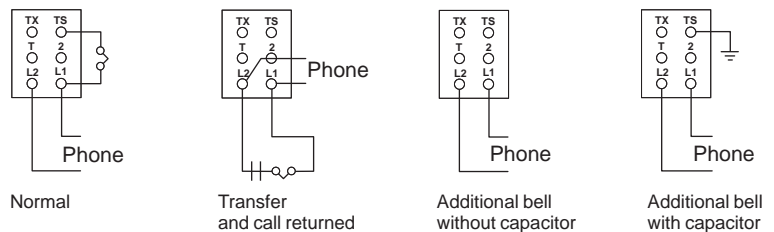
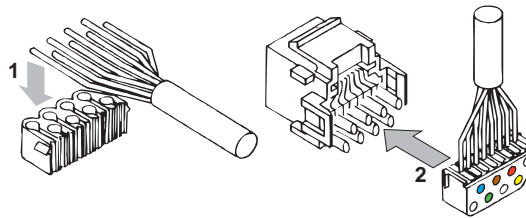

#### Dimensions

##### Screw connection

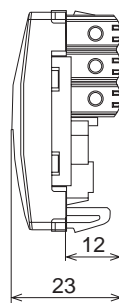

##### Connection by insulator displacement

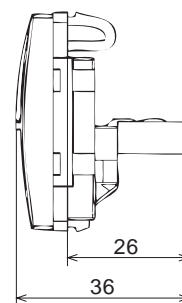

# Unica

## Technical information

### Indicator lamps

#### Area of application

- To indicate load status (On/ Off), room status (occupied/ free), etc., using lamp signals in 4 colours (orange, red, green or colourless).
- This product is an indicator lamp and not suitable for use as emergency lighting.

#### Technical data

Incorporates a neon bulb, ref. MGU0.821.

#### Standards

In accordance with LV and EMC directives.

#### Neon bulb replacement

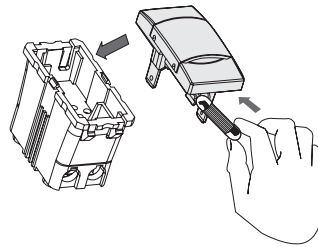

#### Dimensions (mm)

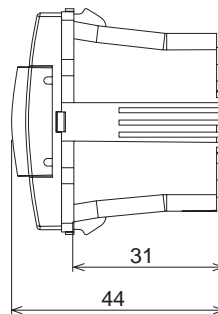

# Buzzers

## MGU3.785.XX

### Area of application

- This product is used as a call signal at the entrance to homes, offices and businesses or to indicate an alert in technical alarm systems (intermittent operation).
- With adjustable volume.

### Technical data

- Rated voltage: 230 V AC  $\pm$  10 %, 50-60 Hz.
- Volume can be adjusted using a screw located on the side.
- Acoustic output: between 76 and 80 dB.
- Consumption: 40 mA.
- Maximum continuous operation time: 60 s.

### Standards

In accordance with LV and EMC directives.

### Volume setting

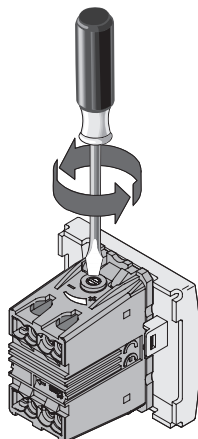

### Connections

- Terminal identification: L (phase), N (neutral)
- Connection terminals: screw connection for cables up to 2 x 1.5 mm<sup>2</sup>.

### Dimensions (mm)

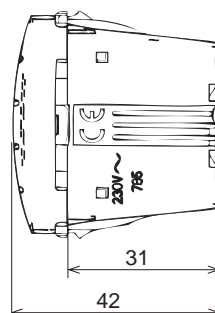

## Area of application

• It is particularly appropriate for homes, offices and so on, where it is necessary to distinguish between someone ringing from outside the building and an internal service bell (for example the electronic door control for the whole building and the entrance door).

## Technical data

- Rated voltage: 230 V AC  $\pm$  10 %, 50-60 Hz.
- Number of programmable melodies: 5.
- Conventional push-buttons with or without indicator lamp can be used for electronic bell:
  - maximum number of push-buttons connected in parallel without indicator lamp: 10,
  - maximum number of push-buttons connected in parallel with indicator lamp: 3.
- Acoustic output: 70 db/ 1 m.
- Consumption: 14 mA.

## Standards

In accordance with IEC 62080.

## Use

The bell has 3 different inputs for the various push-buttons. 5 melodies are provided and a different one can be programmed for each input (see **Melody selection programming**).

### Melody selection programming

- Press the button for 15 s to access the melody programming mode. The bell plays all the available melodies in turn until you press briefly to make your choice. If no melody has been selected within approximately 3 minutes, the bell returns to its initial state and the original melody remains unchanged.
- Different melodies can be selected for the other bell inputs (push-buttons).

## Connections

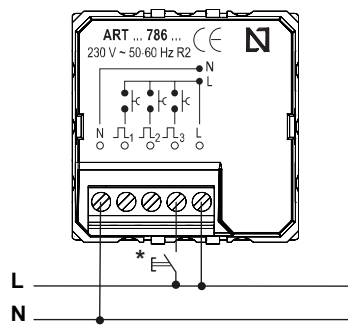

- \* Use of a maximum of 10 push-buttons without indicator lamp connected in parallel or 3 push-buttons with indicator lamp connected in parallel.
- Connection terminals: screw connection for cables up to 2 x 1.5 mm<sup>2</sup>.

## Dimensions (mm)

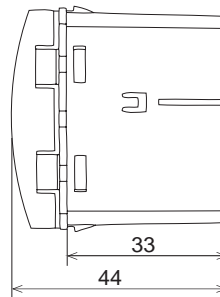



# Unica

## Technical information

### Emergency lights

#### MGU3.776.T

### Area of application

Emergency lighting should the electrical power supply fail in the residential and tertiary sectors, for lighting of stairways, corridors and premises open to the general public.

### Technical data

- Rated voltage: 230 V AC  $\pm$  10 %, 50 Hz.
- Battery charging: 24 h.
- Autonomy: 1 h.
- Green LED: On indicates connection to the electrical network and that the battery is in charging phase or fully charged.
- Green LED: Off indicates that the battery is not being charged.
- Transparent diffuser.
- Battery life: 500 cycles.
- Bulb life: 400 h.
- Bulb and battery cannot be replaced.
- Brightness with diffuser/distance: 45 lux/ 25 cm.

### Standards

In accordance with EN 60598-2-22 concerning emergency lighting and with LV and EMC directives.

### Connections

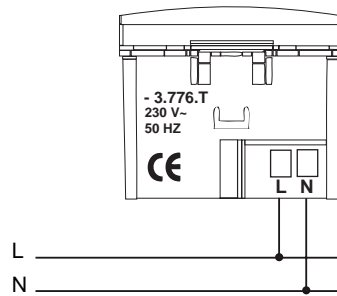

Connection terminals: screw connection for cables up to 2 x 2.5 mm<sup>2</sup>.

### Dimensions (mm)

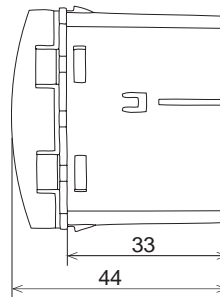

# Autonomous pilotlamps MGU3.780.T

## Area of application

Emergency lighting should the electrical power supply fail in the residential and tertiary sectors, for lighting of stairways, corridors and premises open to the general public.

## Technical data

- Rated voltage: 230 V AC  $\pm$  10 %, 50 Hz.
- Luminous flux: 2 lumens.
- Autonomy: 3 h.
- Batteries: 2 x 1.2 V - 0.3 Ah.
- Minimum charging time: 24 h.
- Impact strength: IK07.

## Standards

In accordance with EN 60598-2-2.

## Use

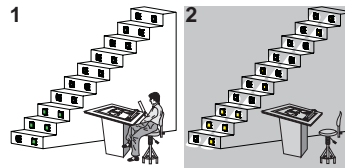

- The autonomous pilotlamp (MGU3.780.T) is connected to the electrical network. When the latter is energised, a green LED lights up on the autonomous pilotlamp (drawing 1). In event of a power cut, the pilotlamp remains lit by means of 2 yellow Leds (drawing 2). The autonomous pilotlamp has an autonomy of 3 h.
- If the electrical network is energised and the green LED is not lit, this means that the battery is completely discharged. The product must then be replaced.

## Dimensions (mm)

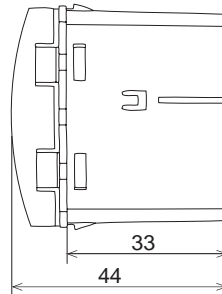

## Area of application

### Universal fixing frames

- Allows clipping on of devices, in horizontal or vertical position.
- They are equipped with:
  - 1: Perforations for fixing to the box to be flush-mounted using screws.
  - 2: Location for optional claws (MGU7.892), supplied housed in a plastic body.
  - 3: Inlets for cover frame rack type guides.
  - 4: Dovetails for a perfect connection when adjoining fixing frames in vertical or horizontal direction.
  - 5: Perforations for direct wall-mounting using pins.

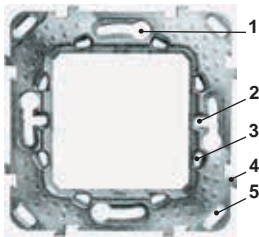

### Italian fixing frames

- Rectangular fixing frame comprise up to 6 modules and accommodate 5 different cover frames of 1, 2, 4 or 6 modules thanks to its design allowing the device to be fixed in any position.
- They are equipped with:
  - 1: Perforations for direct mounting to the wall, a wooden panel, etc. using pins.
  - 2: Screws for fixing to the box to be flush-mounted or on rectangular surface.
  - 3: Inlets for cover frame rack type guides.



## Technical data

- Material: Zamak (zinc and aluminium alloy) or plastic (technopolymer) of very high rigidity and completely rustproof, thus making it resistant long-term and to cleaning products (javel water, ammonia solution, etc.).
- It is ready for insertion of cover frame rack type guides, thus providing a solution for wall irregularities and ensuring proper fastening, including :
  - when the box remains sunk in to up to 2.5 mm on the wall
  - when the box projects by 0.75 mm from the wall.
- Ergonomic design: it exhibits no sharp edges, burr or cutting parts that could be harmful during installation.
- Easier fixing frame alignment thanks to two points:
  - a dovetail system for perfect coupling (for the universal fixing frame)
  - a straight surface to facilitate use of a boning rod.

## Standards

In accordance with EN 60669-1.

## Installation



Fixing frames with long fixed claws and short fixed claws.

### Extension for long claws

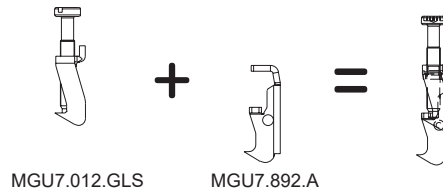

MGU7.012.GLS

MGU7.892.A

## Dimensions (mm)

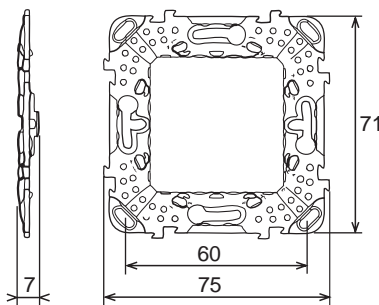

Universal fixing frame with short or long fixed claws (1 gang)

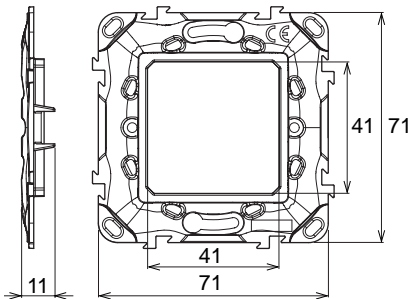

Universal fixing frame without claws (2 gang)

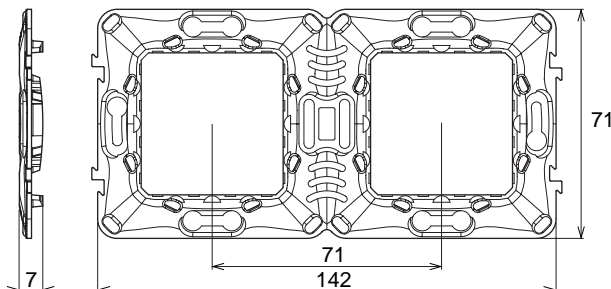

# Unica

## Technical information

### Fixing frames (cont'd)

#### Dimensions (mm)

##### Italian fixing frames

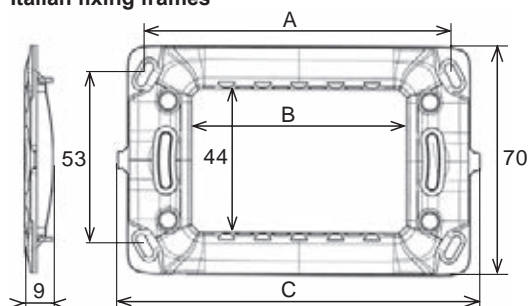

|           | A (mm) | B (mm) | C (mm) |
|-----------|--------|--------|--------|
| 3 modules | 95     | 67     | 112    |
| 4 modules | 117    | 89     | 134    |
| 6 modules | 162    | 134    | 179    |

##### 57 mm interaxis fixing frame with long fixed claws (1 gang)

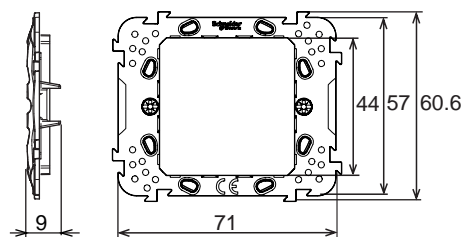

##### 57 mm interaxis fixing frame without claws (1 gang)

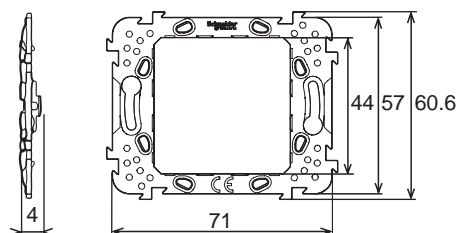

##### 57 mm interaxis fixing frame: example of mounting for 2 gang cover frame

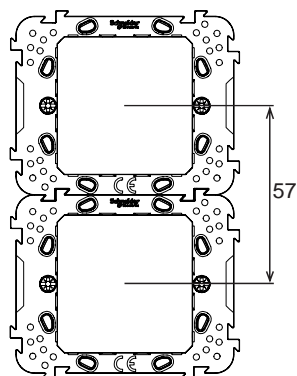

# Unica

## Technical information

### Surface mounting boxes

#### Area of application

- Surface-mounted boxes are used to retrofit premises and homes where it is essential to enlarge or renovate the electrical installation and if costly masonry and paint work is to be avoided.

#### The Unica offer

- For Universal and Italian fixing frames.
- For Unica Basic and Unica Colors cover frames with 1, 2 or 3 elements (up to 2, 4 or 6 modules respectively).
- For Unica Allegro cover frames, up to 3 or 4 modules.

#### Technical and installation data

- Surface-mounted boxes are prepared to accommodate an inlet by means of mini-channels.
- They are equipped with pre-cutouts for direct coupling of mini-channels (without adapter) on the 4 sides.
- The dimensions selected for the mini-channels match those of the UNEX and QUINTELA catalogs: 7 x 12, 10 x 16, 10 x 20, 10 x 35 (dimensions in mm).
- 4 pre-cutouts for direct insertion of 8 mm diameter cables.
- They can be wall-mounted using 4 pins.
- They have perforations at the back so that they can be fixed to a universal box to be flush-mounted and to the old BJC boxes from the "Estrella" series.
- The rear part is equipped with prefabricated slots to facilitate access of cables inside the box.
- Self-extinguishing thermoplastic materials with excellent impact strength and extremely resistant to cleaning products and UV radiation.

#### Dimensions (mm)

##### 1 gang surface mounting box (Unica Colors, Unica Basic)

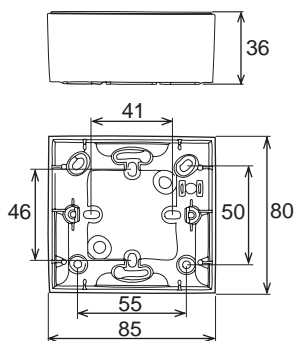

##### 2 gang surface mounting box (Unica Colors, Unica Basic)

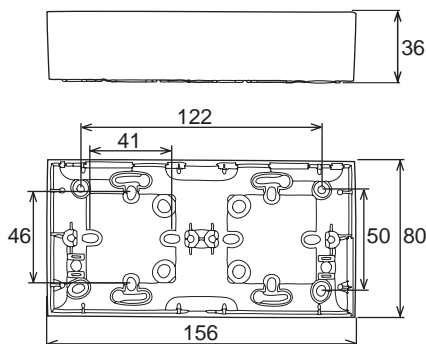

##### 1 gang surface mounting box with clip-on fixing frame (Unica Top, Unica Plus)

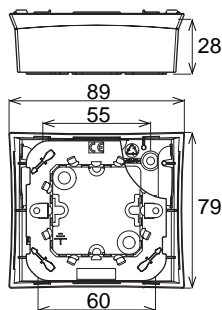

##### 2 gang surface mounting box with clip-on fixing frame (Unica Top, Unica Plus)

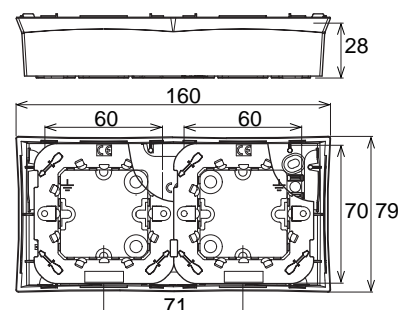

##### 3 gang surface mounting box with clip-on fixing frame (Unica Top, Unica Plus)

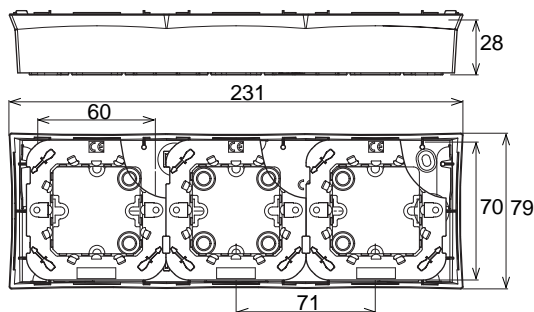

##### 3 gang surface mounting box (Unica Colors, Unica Basic)

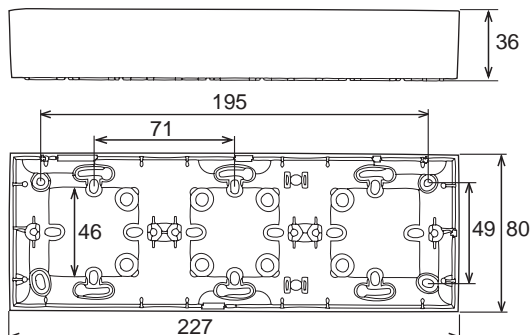

##### Italian surface mounting boxes (Unica Allegro)

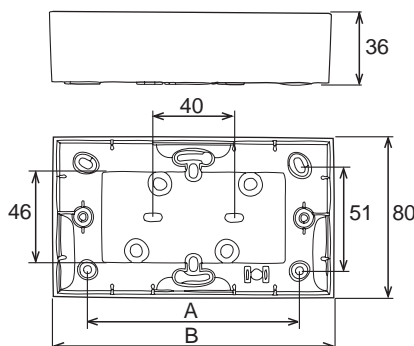

|           | A (mm) | B (mm) |
|-----------|--------|--------|
| 3 modules | 82     | 116    |
| 4 modules | 104    | 139    |

##### Complete assemblies (Unica Basic, Unica Color)

###### 1 gang surface mounting box (cover and fixing frame)

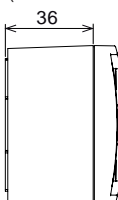

###### 2 gang surface mounting box (cover and fixing frame)

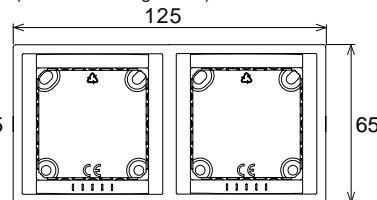

# IP55 surface mounting boxes

## Area of application

• The IP55 level of tightness of these boxes allows **Unica** devices to be installed on terraces, in gardens, garages, car parks, washing tunnels, camp sites, industrial kitchens, etc. Generally speaking in external or damp environments.

### The Unica offer

- **Unica** proposes a double offer of IP55 surface-mounting weatherproof installation systems:
  - IP55 monobloc boxes including the fixing frame,
  - IP55 box cover with fixing frame combinable with IP55 single boxes, IP55 double horizontal and vertical boxes and with triple horizontal boxes.
- All the **Unica** devices can be perfectly clipped on, except for the movement detectors, the key card switches, the cable outlets and the rotary dimmer switches.

## Technical data

- Tightness level: IP55.
- Impact strength: IK07.
- Cables enter via adjustable membranes.
- Cable inlets are 6 to 21 mm in diameter.
- Easy, quick installation by closing bolts.
- Many wall-mounting points.

## Standards

In accordance with EN 60529-91 + E: 93.

## Dimensions (mm)

**IP55 box cover with fixing frame**

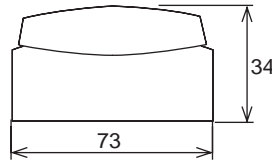

**IP55 monobloc box with fixing frame**

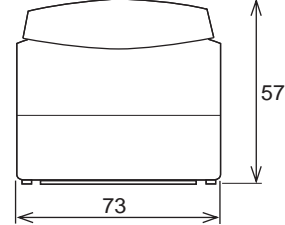

**IP55 single box (1 gang)**

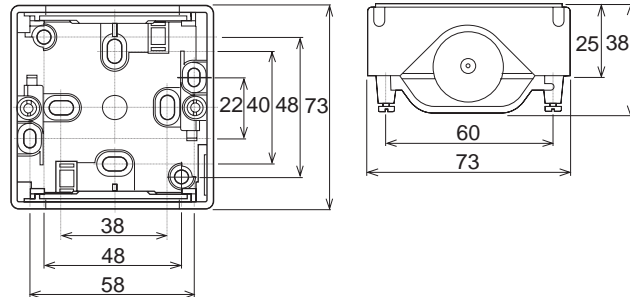

**IP55 double horizontal box (2 gang)**

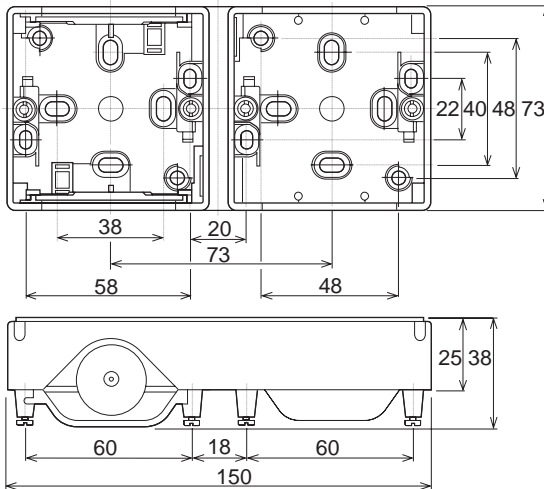

**IP55 double vertical box (2 gang)**

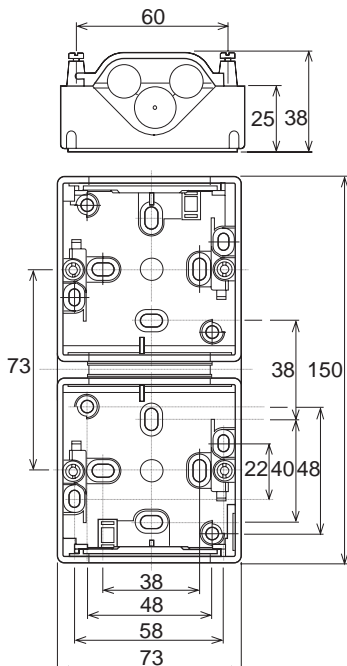

**IP55 triple horizontal box (3 gang)**

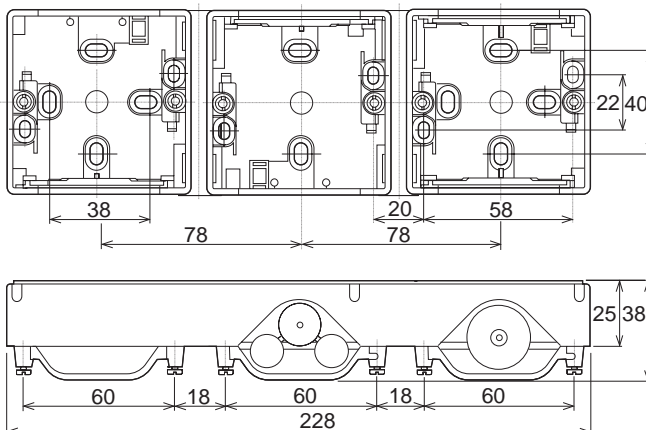

# Unica

## Technical information

### Flush mounting boxes

#### Dimensions (mm) (Cont'd)

2 x 4 modules flush mounting box

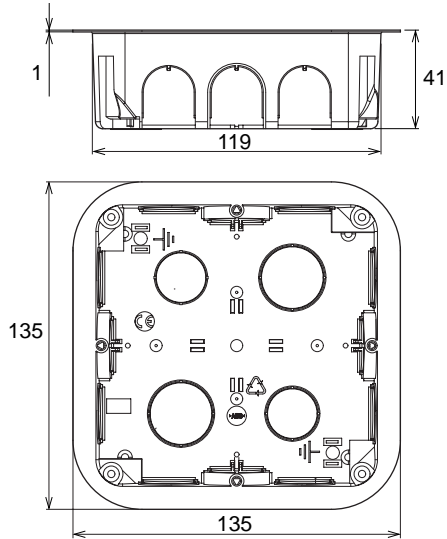

2 x 6 modules flush mounting box

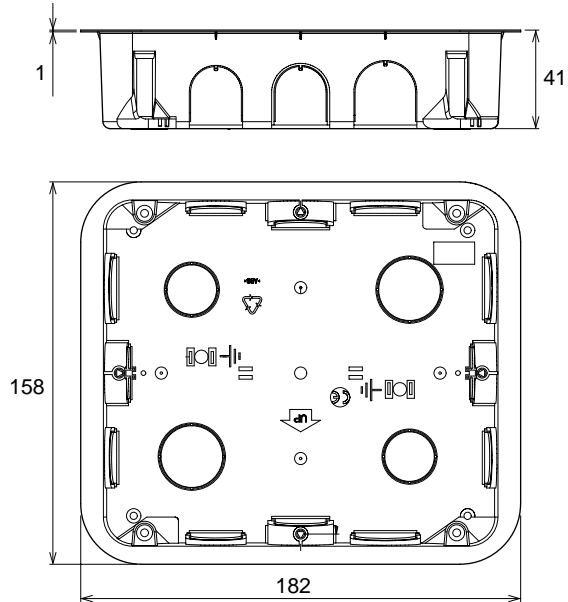

4 modules italian flush mounting box

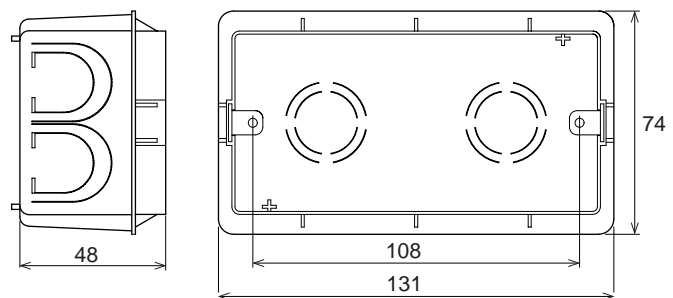

3 modules italian flush mounting box

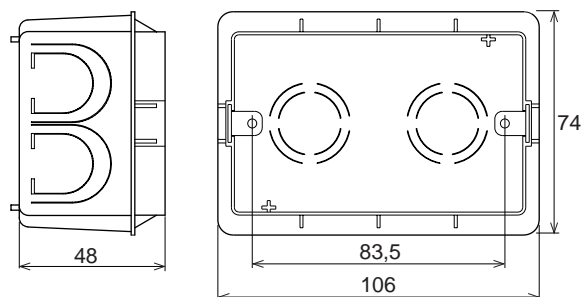

Insulated box for thin panels (Unica Top, Unica Basic)

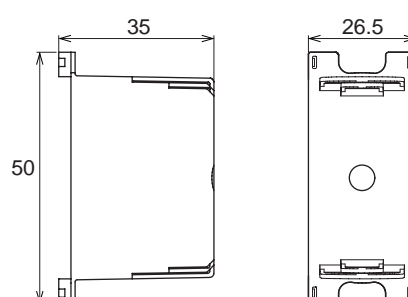

### Area of application

- **Unica Basic** to be installed in the universal box. It is supplied with cover frames with 1 to 4 gang, for mounting in horizontal or vertical position (for vertical mounting, the embellishment supplied with the cover frame must be rotated by 90 °). It is available in 4 colors
- **Unica Colors** to be installed in the universal box. It is supplied with cover frames with 1 to 4 gang, for mounting in horizontal or vertical position.
  - range of embellishments with 18 possible finishes.
  - 2 mounting directions according to whether the cover frame is installed in horizontal or vertical position. The touch sensitive protrusions must be placed on the bottom part.
- **Unica Quadro** to be installed in the universal box. It is supplied with cover frames with 1 to 4 gang, for mounting in horizontal or vertical position (for vertical mounting, the embellishment supplied with the cover frame must be rotated by 90 °). It is available in 14 colors.
- **Unica Allegro** to be installed in the rectangular box. It is supplied with cover frames with 1, 2, 3, 4 or 6 modules.
- **Unica Top** and **Unica Plus** to be installed in the universal box with 1 to 4 gang in horizontal position and 1 to 3 gang in vertical position.
- The **Unica Top** and **Unica Basic** ranges can be mounted, with narrow cover and fixing frames for thin panel.
- The **Unica Top**, **Unica Plus**, **Unica Colors** and **Unica Basic** ranges can be mounted with supplementary frames to cover the irregularities on the wall, for the versions with 1, 2 and 3 gang.

### Technical data

- All **Unica** finishes are resistant to cleaning products and UV radiation.
- Recyclable thermoplastic materials.
- Self-extinguishing thermoplastic materials with excellent impact strength.
- The **Unica Top** range incorporates Zamak cover frames with electroplating and finishes made of natural wood, not deformable, having undergone an anti-fungal treatment.
- Cover frames are mounted by means of rack type guides eliminating wall irregularities in vertical position:
  - when the box remains sunk in to up to 2.5 mm on the wall.
  - when the box projects by 0.75 mm from the wall.

### Standards

In accordance with EN 60669-1.

### Dimensions (mm)

#### Unica Basic, Unica Colors and Unica Quadro

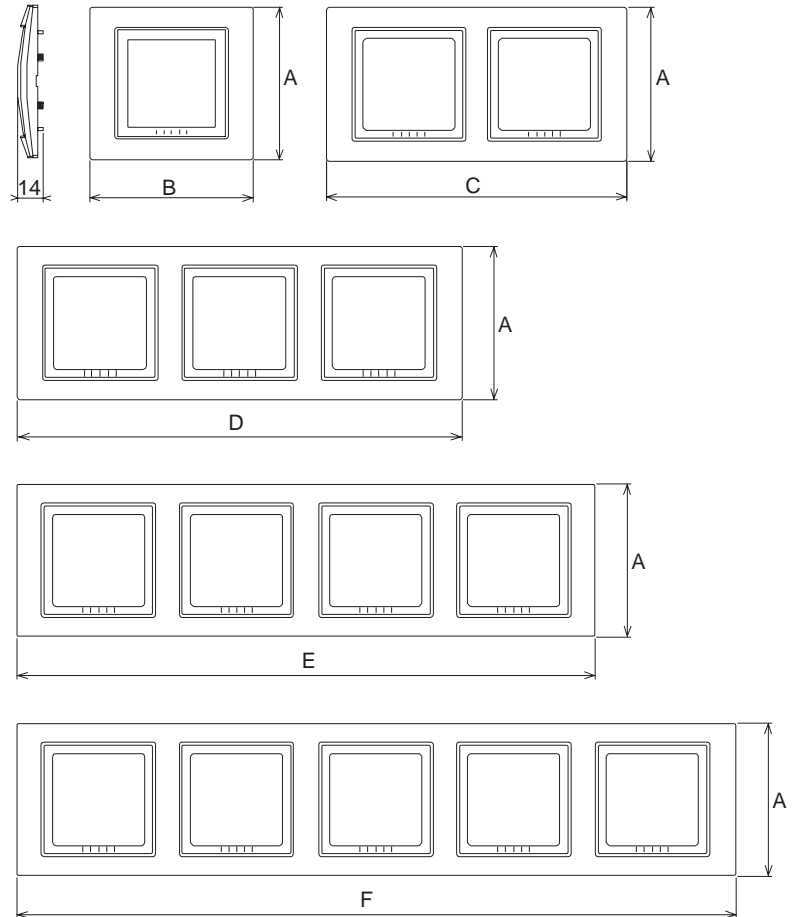

|              | 1 gang | 1 gang | 2 gang | 3 gang | 4 gang | 5 gang |
|--------------|--------|--------|--------|--------|--------|--------|
|              | A (mm) | B (mm) | C (mm) | D (mm) | E (mm) | F (mm) |
| Unica Basic  | 80     | 85     | 156    | 227    | 298    | 373    |
| Unica Colors |        |        |        |        |        |        |
| Unica Quadro | 87     | 87     | 158    | 229    | 300    |        |

#### Unica Basic and Unica Colors, Supplementary frames

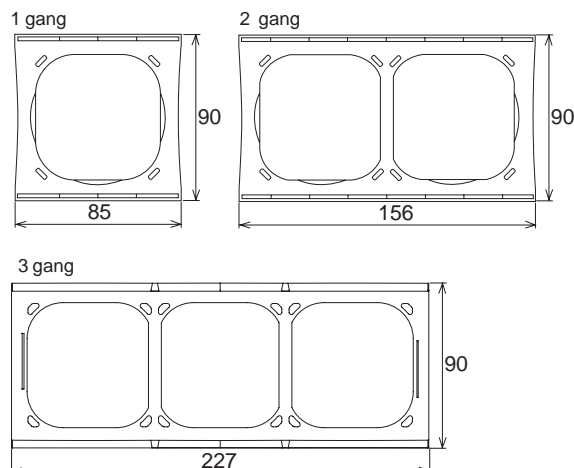



# Unica

## Technical information

### Cover frames (cont'd)

#### Dimensions (mm) (Cont'd)

##### Unica Basic, cover and fixing frame for thin panel

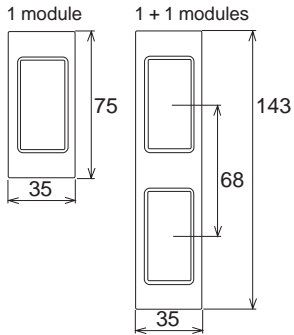

##### Unica Allegro, Quadro

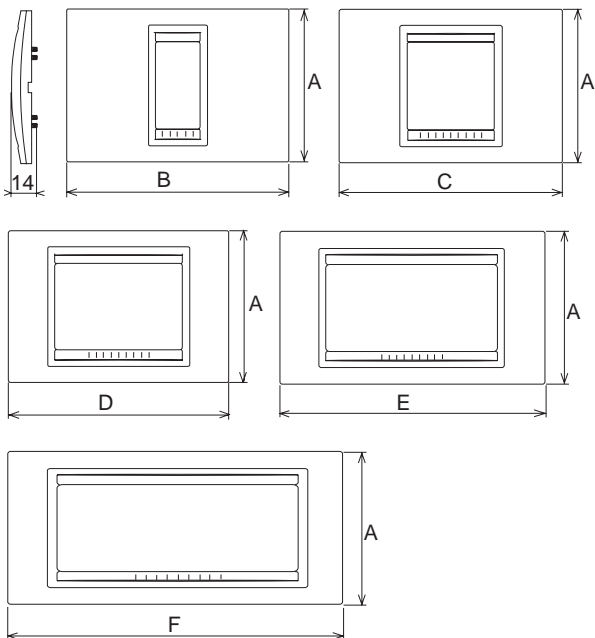

|               | 1 module | 2 modules | 3 modules | 4 modules | 6 modules |        |
|---------------|----------|-----------|-----------|-----------|-----------|--------|
|               | A (mm)   | B (mm)    | C (mm)    | D (mm)    | E (mm)    | F (mm) |
| Unica Allegro | 80       | 116       | 116       | 116       | 139       | 193    |
| Unica Quadro  | 87       | 116       | 116       | 116       | 139       | 193    |

# Unica Technical information Cover frames (cont'd)

## Dimensions (mm) (Cont'd)

### Unica Top and Unica Plus

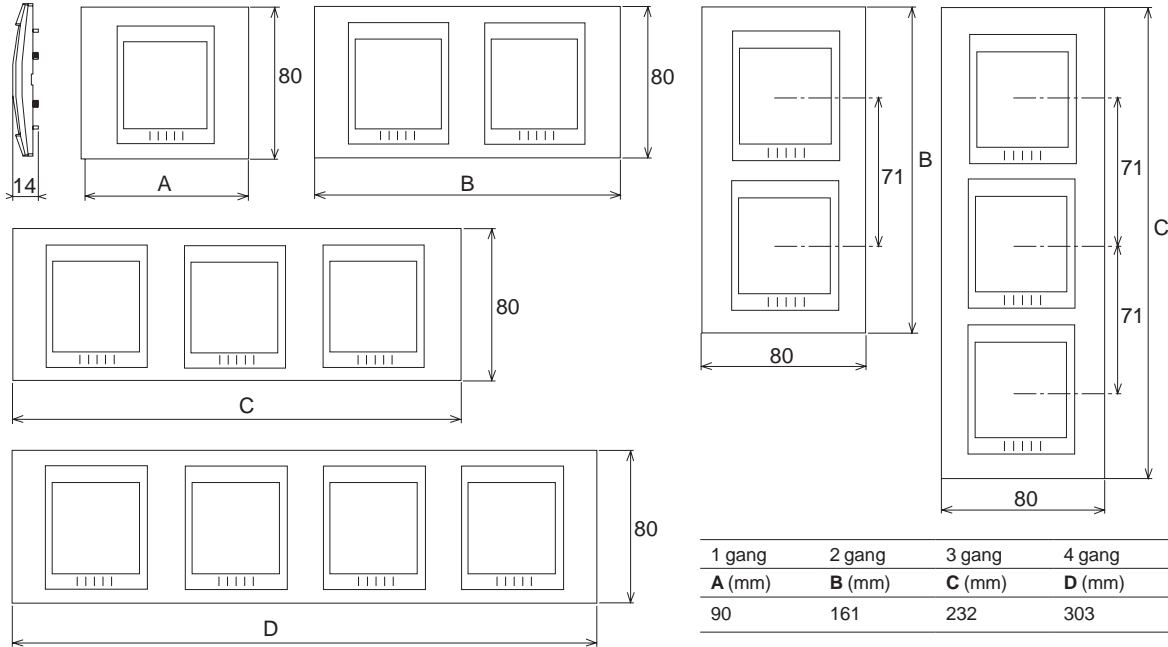

### Unica Top and Unica Plus 57 mm interaxis

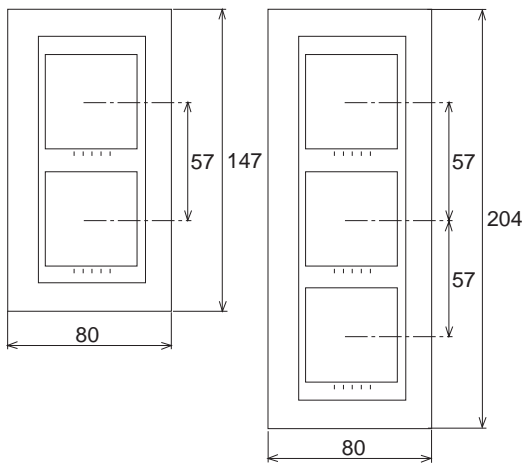

### Unica Top, cover and fixing frame for thin panel

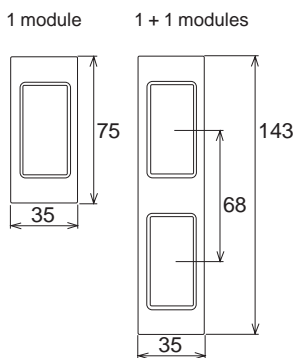

### Unica Top and Unica Plus (Italian)

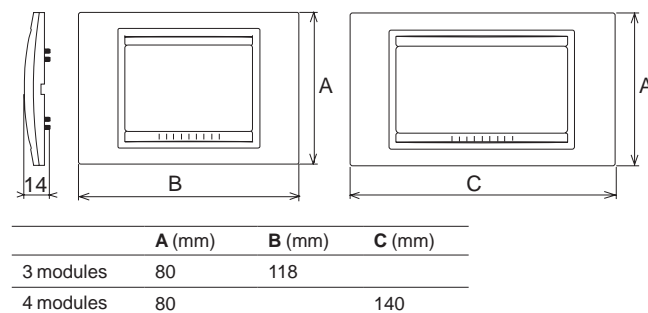

# Unica

## Technical information

### Cover frames (cont'd)

#### Dimensions (mm) (Cont'd)

##### Unica Top and Unica Plus, supplementary frames

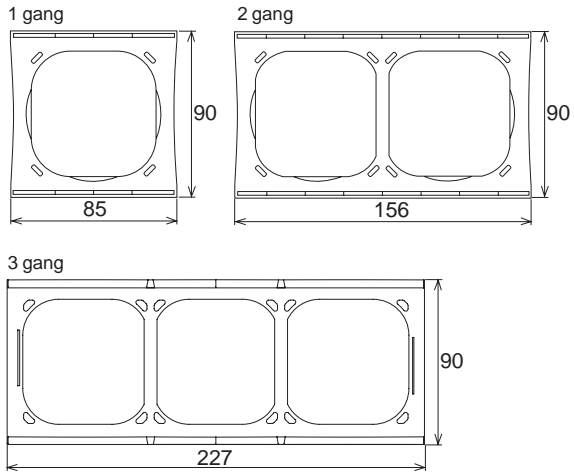

##### Unica Top and Unica Plus

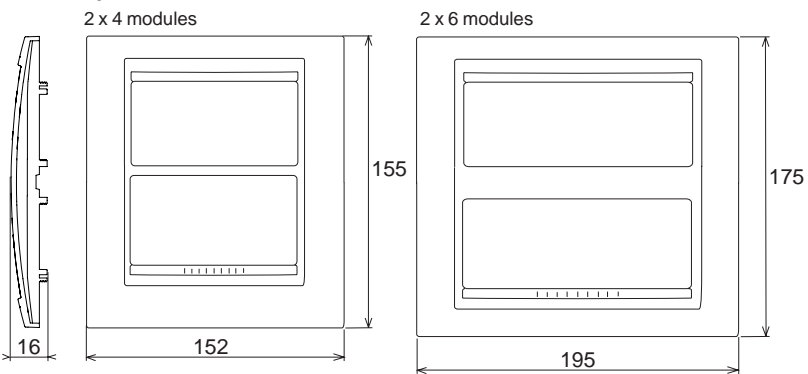

##### Unica Plus, IP44 cover and fixing frame (with or without claws)

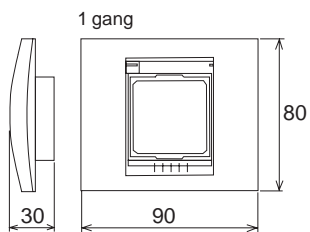

##### Unica Plus, IP55 cover and fixing frame

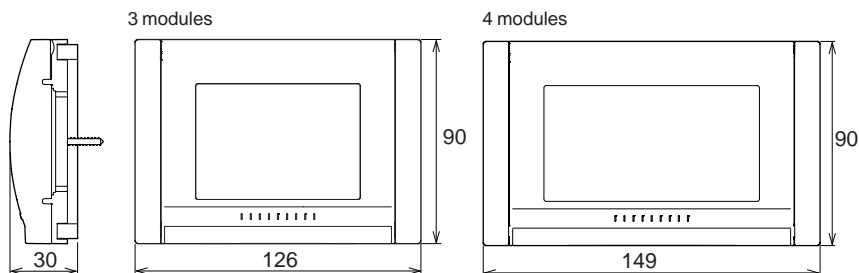

# Unica

## Technical information

### Cover frames (cont'd)

#### Unica Class

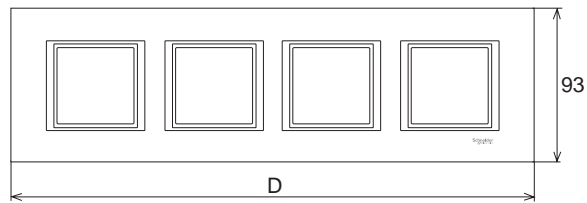
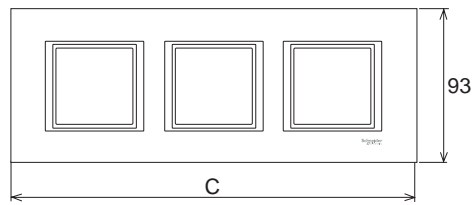
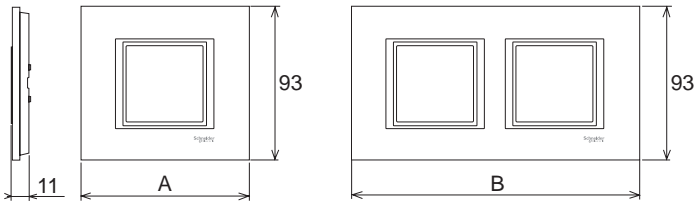

| 1 gang | 2 gang | 3 gang | 4 gang |
|--------|--------|--------|--------|
| A (mm) | B (mm) | C (mm) | D (mm) |
| 102    | 173    | 244    | 315    |



# Unica Wireless



# Wireless comfort

Unica Wireless is a range of wireless products which use radio technology (RF) to exchange information. The products are highly suitable for refurbishment work in residential and small building environments without damaging the walls.

They make it considerably easier and far more pleasant to control lighting and roller blinds in the home. They are simple to install and program.

## Scenario 1: Add a switch

Add a switch beside the bed to switch the bedroom ceiling lamp on or off without getting up.

- Replace the existing switch with a Unica Wireless combined module.
- Stick a new battery-powered push-button onto the wall beside the bed.
- Link them by simple programming.



## Scenario 2: Create a centralised roller-blind control system

Create a centralised roller-blind control system to open or close all the blinds in the house with just one button.

- Replace each individual roller-blind control with a Unica Wireless roller-blind module.
- Stick a Unica Wireless battery-powered push-button for the centralised control in the required position.
- Link them by simple programming.



## Scenario 3: Create lighting scenarios

Create lighting scenarios to change the lighting atmosphere instantly in different rooms: for watching TV, cooking, etc.

- Replace the existing switches by Unica Wireless combined modules.
- If necessary, add mobile socket outlets to connect standard lamps, table lamps, etc.
- Add a battery-powered push-button with the symbols corresponding to the various scenarios.
- Link them by simple programming.





## Scenario 4: Control the lighting and roller-blinds in each room

Control the lighting and roller blinds in each room by grouping all the controls together in one place and duplicating them on a remote control.

- Replace the existing switches (light, blinds) by wireless combined modules.
- Stick battery-powered push-buttons in convenient places.
- Stick battery-powered push-buttons in convenient places.
- Add a remote control containing the main functions.
- Link them by simple programming.

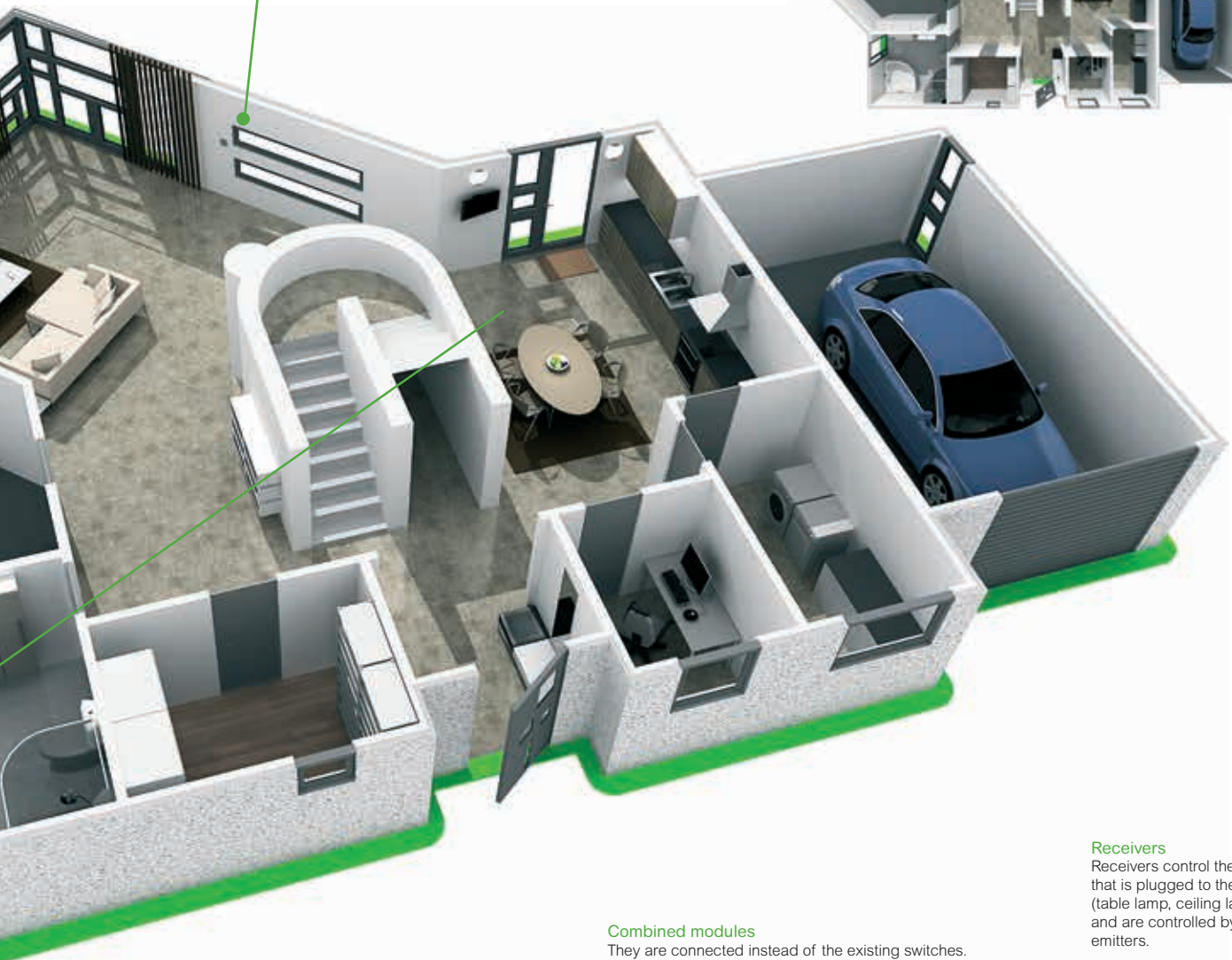

### Emitters

Emitters are battery-operated and can be screwed or stuck wherever you wish to add a control point, without connecting them to the mains supply.



Battery-powered push-button



Keyring remote control

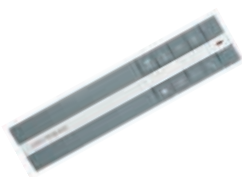

Metal remote control



Universal wireless emitter

### Combined modules

They are connected instead of the existing switches. The key is used for local control; when a second key is mounted it can be used as an emitter to pilot another wireless receiver.



Combined relay or dimmer



Combined module for roller-blind

### Receivers

Receivers control the load that is plugged to them (table lamp, ceiling lamp, etc.) and are controlled by the emitters.



Mobile socket-outlet, relay or dimmer



Universal wireless receiver (relay)

# A complete range of wireless products

## Flexibility



The emitters and combined units can be 1 or 2-key units. They are supplied with a kit of rockers which allow to mount the product with 1 or 2 keys according to the requirements of the application. The icons are removable and can be easily replaced to match the function of the product.

## Simplified programming

Emitters and receivers are linked by simple programming.

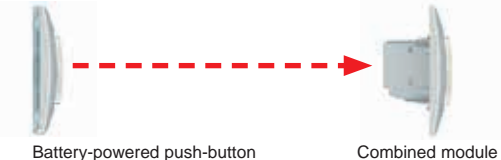

Battery-powered push-button

Combined module

The rockers can be removed to access the programming keys.

To link wireless products, simply:

- Press the «A» key on the emitter.
- Press the pole (1, 2, etc.) on each emitter.
- Press the «A» key on the receivers.
- Finally, press the «A» key on one of the products.

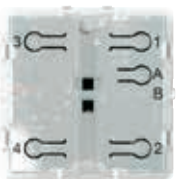

## Personalize



The wireless products are available in 4 different finishings:

- White or Ivory for Unica Basic, Unica Colors and Unica Plus.
- Aluminium or Graphite for Unica Top and Unica Class.

## A range designed to be integrated into Unica

The Unica wireless products can be used with Unica Basic, Unica Colors, Unica Plus and Unica Top cover frames for a perfect matching with your home.

### Integration of an emitter:

- The emitter is supplied with a flat integrated fixing frame.
- It can be easily glued or screwed on any type of wall.

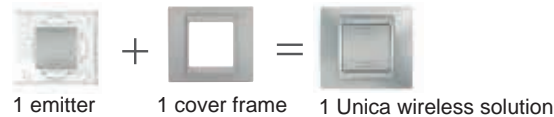

### Integration of a combined module:



## Technical advantages

- Unica Wireless products have an outdoor range of 300 m and an indoor range of 10 to 50 m. For battery-powered products, the wireless technology link has been optimised to extend the life of the battery (5 to 7 years, depending on its use).
- There are two possible programming modes:
  - The Control mode is used to set up a link between emitters and receivers for simple control function (on, off, dim).
  - The Scenario mode allows you to link with a particular button the lighting atmospheres you have created.
- The kit of rockers supplied permits to have 1 or 2 keys, depending on the application. It is also a good way to start with a simple application (one key) and then upgrade to a more sophisticated application, by simply mounting 2 keys.
- The symbols on the rockers can be easily removed and replaced.
- The programming is not lost when you change the battery (or during a mains power failure).

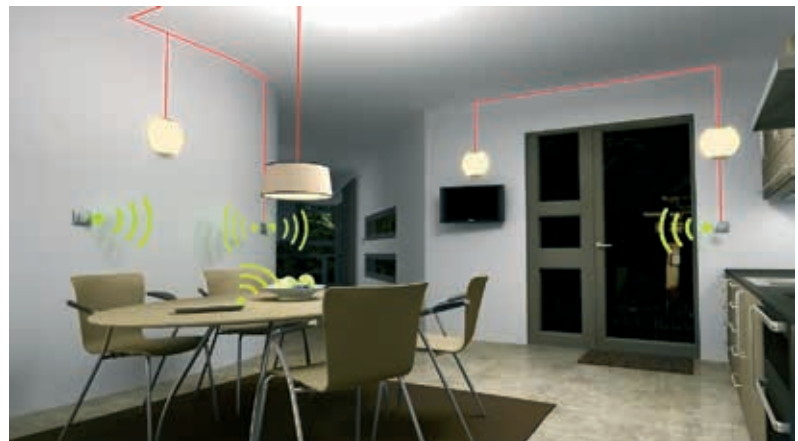

# Add switches for more comfort



## Initial situation

In the bedroom, the ceiling lamp is controlled by a single switch.

## Requirement

Add switches to control the lighting from the head of the bed.

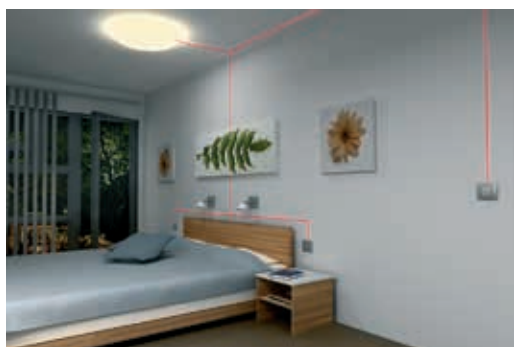

## The conventional solution

Create a wired two-way switch.

## The disadvantages

- Wires, cables and shields have to be drawn through the wall.
- Dust and damaged walls.
- Lengthy, tedious and expensive work.
- Cabling has to be installed (wires, cable, shield).
- Cabling has to be changed.

## The Unica Wireless solution

- Replace the existing switch by an Unica Wireless combined module.
- Stick two battery-powered emitters onto the wall beside the bed.
- Link them, using the programming system.

## The advantages

- Quick and easy to install.
- No damage.
- Most affordable solution.

## Optional functions

- Use a combined dimmer to add the «dimming» function.
- Add a remote control.
- Control bedside lamps from the main switch, by adding a mobile socket outlet.



## Unica Wireless products to be used

| Descriptions  | References                               |
|---|--|
| 1 - Combined module (relay or dimmer)                           | <b>MGU3.572.XX</b><br><b>MGU3.573.XX</b> |
| 2 - Battery-powered push-buttons (Unica Colors and Unica Basic) | <b>MGU84.071.XX</b>                      |
| Battery-powered push-buttons (Unica Top and Unica Plus)         | <b>MGU86.071.XX</b>                      |
| Battery-powered push-buttons (Unica Class)                      | <b>MGU88.071.XX</b>                      |

### Initial situation

Each light has its own mechanical switch.

### Requirement

Create scenarios to control the lighting atmosphere at the touch of a single button.



#### Scenario 1

##### «cooking»



A program that can be set to switch on the kitchen and dining lighting at the same time:

- A- the kitchen wall light is set to 100%
- B- the dinner table ceiling light is set to 100%

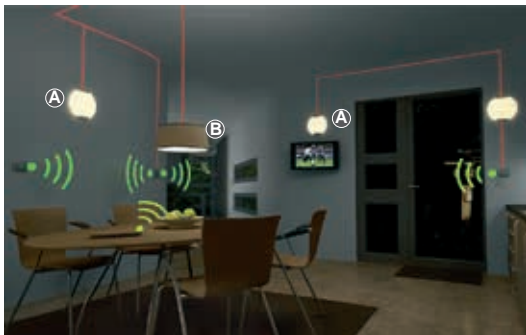

#### Scenario 2

##### «watching television»



A program that can be set to adapt the lighting for watching television:

- A- the kitchen wall light is set to 30%
- B- the dinner table ceiling light is set to 40%

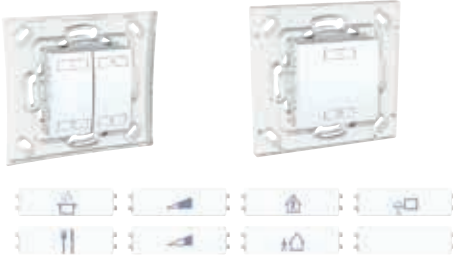

Battery-powered push-buttons with set of symbol for scenarios

#### Scenario 3

##### «coming home»



A program that can be set to switch on the various lights that have been preset for when you arrive home.

Note: the scenario should always include a function that switches off all the lights.

#### Scenario 4

##### «going out/all lights off»



A program that can be set to switch off all the lights.

### Optional functions

- Add a remote control.
- Add the roller blind control to a scenario.

### Unica Wireless products to be used

| Descriptions   | References                                   |
|--|--|
| 1 - Battery-powered push-buttons (Unica Colors and Unica Basic)<br>Battery-powered push-buttons (Unica Top and Unica Plus)<br>Battery-powered push-buttons (Unica Class) | MGU84.071.XX<br>MGU86.071.XX<br>MGU88.071.XX |
| 2 - Mobile socket-outlet   | CCT1A0XX                                     |
| 3 - Combined modules   | MGU3.572.XX<br>MGU3.573.XX                   |
| 4 - Set of symbols for scenarios   | MGU0.570.XX                                  |
| 5 - Metal remote control   | CCT1A000                                     |



# Centralised roller blind control



### Initial situation

Each electric blind has its own individual control. You have to go from one blind to another to close them.

### Requirement

Open or close all the roller blinds with just one button.



### The conventional solution

Create a wired centralised control system.

### The disadvantages

- Wires, cables and shields have to be drawn through the wall.
- Dust and damaged walls.
- Lengthy, tedious and expensive work.
- Cabling has to be installed (wires, cable, shield).

### The Unica Wireless solution

- Replace each individual roller blind control by an Unica Wireless roller blind module.
- Stick an Unica Wireless push-button in the required position, for centralised control.
- Link them, using the simplified programming system.

### The advantages

- Simple, quick and less expensive to install.
- No damage.
- One of the wireless modules for roller blinds can be used as the centralised control (using the second key).

### Optional functions













Add a remote control.



### Unica Wireless products to be used







| Descriptions   | References                                   |
|--|--|
| 1 - Battery-powered push-buttons (Basic and Colors)<br>Battery-powered push-buttons (Plus and Top)<br>Battery-powered push-buttons (Unica Class) | MGU84.071.XX<br>MGU86.071.XX<br>MGU88.071.XX |
| 2 - Combined module for roller blinds  | MGU3.574.XX                                  |
| 3 - Metal remote control   | CCT1A000                                     |

### Unica Wireless range

| Product type  | Description                          | Notes   | Reference  | Rockers supplied  |
|---|--------------------------------------|---|--|---|
| <b>Emitters</b>   |                                      |   |  |   |
|    | Battery-powered push-button          | The push-button can control receivers for both light and/or roller blinds.<br>It can be mounted with one or two keys using the kit of rockers supplied.<br>Can be screwed or stuck; no connection required.<br>Supplied with a 3 V battery.   | <b>MGU84.071.XX</b><br>(Unica Colors & Basic)<br><b>MGU86.071.XX</b><br>(Unica Top & Plus)<br><b>MGU88.071.XX</b><br>(Unica Class) |    |
|    | Universal emitter                    | The universal emitter transforms any conventional push-button into a wireless emitter.<br>Can be fitted in the flush-mounted boxes behind the push-buttons.<br>Supplied with a 3 V battery.<br>Can control receivers for both light and/or roller blinds.   | <b>CCT1A030</b>  |   |
|    | Metal remote control                 | 8 keys that can be programmed in simple or scenario mode.<br>Sleek design and elegant aesthetic.<br>Supplied with batteries and 32 symbols.   | <b>CCT1A000</b>  |    |
|   | Keyring remote control               | 4 keys to program in simple or scenario mode.<br>Convenient design to be used as a keyring or to be placed in the pocket.   | <b>CCT1A010</b>  |   |
| <b>Combined modules (emitters-receivers)</b>  |                                      |   |  |   |
|  | Combined module relay (with neutral) | Relay, with neutral, max. 10 A / 2300 W.<br>Can replace an existing switch in a box, minimum 40 mm.<br>Can be fitted with one or two keys, using the kit of rockers supplied.<br>When only one rocker is mounted, it pilots the local load. When a second rocker is mounted, it can pilot remotely other wireless receivers.  | <b>MGU3.572.XX</b>   |  |
|  | Combined module dimmer               | Universal dimmer <b>(1)</b> , without neutral, 20-315 W.<br>Can replace an existing switch in a box, minimum 40 mm.<br>When only one rocker is mounted, it pilots the local load. When a second rocker is mounted, it can pilot remotely other wireless receivers.  | <b>MGU3.573.XX</b>   |  |
|  | Combined module roller blind         | Relay for roller blinds, max. 3 A / 690 W.<br>Can replace an existing mechanical command for roller-blind. To be installed in a box, minimum 40 mm.<br>Can be fitted with one or two keys using the kit of rockers supplied.<br>When only one rocker is mounted, it pilots the local roller-blind. When a second rocker is mounted, it can pilot remotely other wireless receivers. | <b>MGU3.574.XX</b>   |  |

**(1)** Universal: controls the main types of lamps with dimmable lighting; with auto-detection of the type of lamp.

### Unica Wireless range

| Product type  | Description                                    | Notes   | Reference       |
|---|--|---|-----------------|
| <b>Receivers</b>  |  |   |                 |
|    | Mobile socket-outlet relay<br>German standard  | Relay, max. 10 A.<br>Plugs into a fixed socket.<br>With a key for local control (ON/OFF)  | <b>CCT1A020</b> |
|    | Mobile socket-outlet dimmer<br>German standard | Universal dimmer (1), max. 250 W.<br>Plugs into a schuko fixed socket.<br>With a key for local control (ON/OFF/dimming)   | <b>CCT1A021</b> |
|    | Mobile socket-outlet relay<br>French standard  | Relay, max. 10 A.<br>Plugs into a french fixed socket.<br>With a key for local control (ON/OFF)   | <b>CCT1A022</b> |
|    | Mobile socket-outlet dimmer<br>French standard | Universal dimmer (1), max. 250 W.<br>Plugs into a french fixed socket.<br>With a key for local control (ON/OFF/dimming)   | <b>CCT1A023</b> |
|    | Universal receiver relay                       | Receiver relay, max. 10 A.<br>To be hidden mounted (in a box, minimum 40 mm) or in a false-ceiling.   | <b>CCT1A031</b> |
| <b>Accessories</b>  |  |   |                 |
|  | Test kit                                       | Two identical products to test the signal strength between two locations.<br>The led indicates the reception level: green, orange, red.<br>Supplied in a mini-suitcase. | <b>CCT1A090</b> |

(1) Universal: controls the main types of lamps with dimmable lighting; with auto-detection of the type of lamp.

### Detailed presentation of the range

Unica Class & Top: see page 54.

Unica Plus, Colors, Basic: see page 109.

# Battery powered push-buttons

MGU84.071.XX - MGU86.071.XX - MGU88.071.XX

## Area of application

The Unica wireless battery-powered push-buttons are used to control Unica wireless receivers for both light and roller blinds such as; combined modules and mobile socket outlets.

## Technical data

- Transmission frequency: 868 MHz.
- Transmission distance: up to 300 m outdoor and typically 10-50 m indoor (depending on the construction material).
- Battery: 3 V button battery, CR2032 type.
- Battery life time: depends on use, usually between 5 and 7 years (approximately 20,000 operations at 20°C).
- Operating temperature: - 5°C to + 50°C.
- Humidity: 20% - 95% without condensation.
- Protection class: IP 20.

## Standards

In accordance with:

- EN 61000-6-2, EN 61001-6-3.
- ETSI EN 300220, ETSI EN 301489.
- EMC directive: 89/336/EEC.
- R&TTE directive: 99/5/EEC.

## Symbols for scenarios

- When this product is used in a scenario mode, you can add symbols to match the function of the product.
- Set of 16 symbols for scenarios.
- Reference MGU0.570.XX.



## Advantages

- You can easily convert a wired one-way switch into a two-way switch.
  - Just replace it with a combined relay (or combined dimmer) and add one or more battery-powered push-buttons.
  - The conversion does not require any rewiring or other work that will damage the room (walls, wallpaper, paintwork, etc.). It can all be completed in just a few minutes, without any dust and without moving any furniture.
- It takes just a few moments to add an extra control point.
- You can mount the 2 modules cover on the battery powered push-button device to control one receiver and you can easily replace the 2 modules cover by two 1 module covers to control other receivers.

## Installation

- They can be screwed or stuck directly onto the wall (with glue, adhesive tape, etc.); they can be installed anywhere in the house: at the end of the bed, in a corridor and on all types of materials (glass, wood, etc.).
- Each push-button can be programmed in Simple mode or Scenario mode using the supplied set of symbols for the various functions.

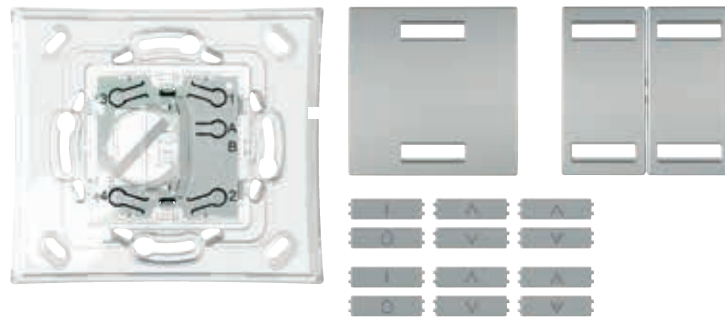

- The Unica wireless battery-powered push-button is supplied with:
  - A CR2032 type lithium battery.
  - 2 narrow covers (1 module covers).
  - 1 large cover (2 modules cover).
  - A set of 12 symbols to customize the covers: 2 symbols «1/0», 2 symbols «dimmer-up/dimmer-down» and 2 symbols «roller blind up/roller blind down, roller blind all-up/all-down».

## Programming

Programming operation follows the same principles as described in the «Unica wireless system» part.

## Dimensions (mm)

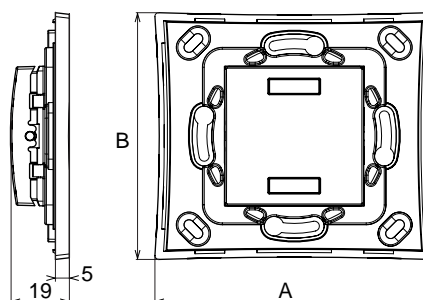

|                           | A (mm) | B (mm) |
|---------------------------|--------|--------|
| Unica Colors, Unica Basic | 80     | 80     |
| Unica Top, Unica Plus     | 90     | 80     |
| Unica Class               | 96     | 88     |



# Unica wireless

## Technical information

### Universal emitter

#### CCT1A030

### Area of application

- The Unica universal emitter is used to convert any push-button (but not the switches) to a wireless emitter.
- It control Unica wireless receivers such as universal receiver relays, combined modules or mobile socket-outlets.

### Technical data

- 4 wireless channels for programming in Simple or Scenario mode.
- Transmission frequency: 868 MHz.
- Transmission distance: up to 100 m outdoor and typically 10-50 m indoor (depending on the construction material).
- Battery: Lithium battery, CR2032 type (1 battery supplied).
- Battery life time: depends on use, usually between 5 and 7 years (approximately 20,000 operations at 20°C).
- Operating temperature: - 5 °C to + 50 °C.
- Humidity: 20% - 95% without condensation.

### Standards

In accordance with:

- EN 61000-6-2, EN 61001-6-3.
- ETSI EN 300220, ETSI EN 301489.
- EMC directive: 89/336/EEC.
- R&TTE directive: 99/5/EEC.

### Installation

- The universal emitter is to be hidden-mounted, close to the push-buttons, for example behind the push-buttons in the installation box.
- Metal surfaces close to the transmitter can affect emission. If possible, avoid to install the flush mounted transmitter in a metal box.
- Never install the universal emitter in a flush mounted box where there are 230 V cables.

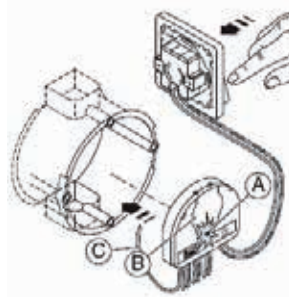

A: Programming LED  
B: Battery location  
C: Antenna

### Programming

- Programming operation follows the same principles as a normal battery-powered push-button.
- Each of the four wire pairs represents one side of a rocker.

### Connections

- If only 1 function is needed (e.g. on/off), only connect the pairs E1 and E2 to push-buttons.
  - The push-button connected to pair E1 will be used for ON (or dim-up with a long push for a dimmer).
  - The push-buttons connected to pair E2 will be used for OFF (or dim-down with a long push for a dimmer).
- If 2 functions are needed, connect also E3 and E4 to 2 push-buttons.

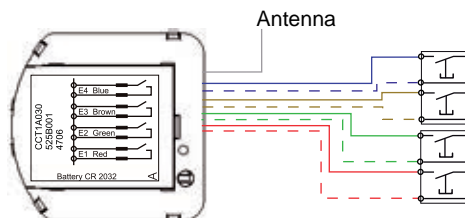

Input E4: blue and white-blue cables, input E3: brown and white-brown cables, input E2: green and white-green cables, input E1: red and white-red cables.

### Dimensions (mm)

- H x W x D : 42 x 40 x 12 mm without cables.
- Cables length: 270 mm.

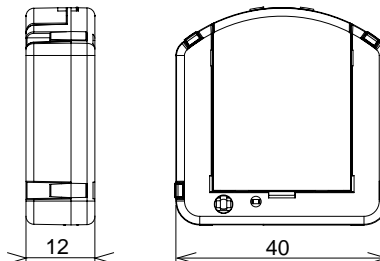

# Unica wireless

## Technical information

### Metal remote control

#### CCT1A000

#### Area of application

- The Unica metal remote control is used to remotely control the Unica wireless receivers and combined modules.
- Its elegant design and particularly stylish finish makes it a decorative object that can be left in full view on a piece of furniture.

#### Technical data

- 8 channels which can be programmed in Simple or Scenario mode.
- Transmission frequency: 868 MHz.
- Transmission distance: 300 m outdoor and typically 10-50 m indoor (depending on the construction material).
- Battery: 2 AAA (LR3) batteries (2 batteries supplied).
- Operating temperature: - 5 °C to +50 °C.
- Humidity: 20% - 95% without condensation.
- Protection class: IP 20.

#### Standards

- In accordance with:
- EN 61000-6-2, EN 61001-6-3, IEC60068-2-6, IEC60068-2-27.
  - ETS300220-1, ETS300220-2.
  - EMC directive: 2004/108/EC.
  - R&TTE directive: 99/5/EEC.

#### Advantages

- The metal remote control can be customized via its set of 32 keys containing a large number of symbols.
- Its keys can be fitted for vertical or horizontal use to control the lighting and roller blinds.
- The metal remote control is supplied with:
  - 32 keys with symbols.
  - 2 AAA (LR3) batteries.



8 keys to remotely control the lighting and roller blinds

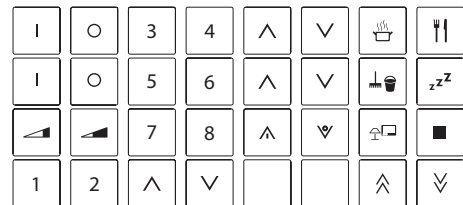

32 keys with symbols to customize the metal remote control

#### Dimensions (mm)

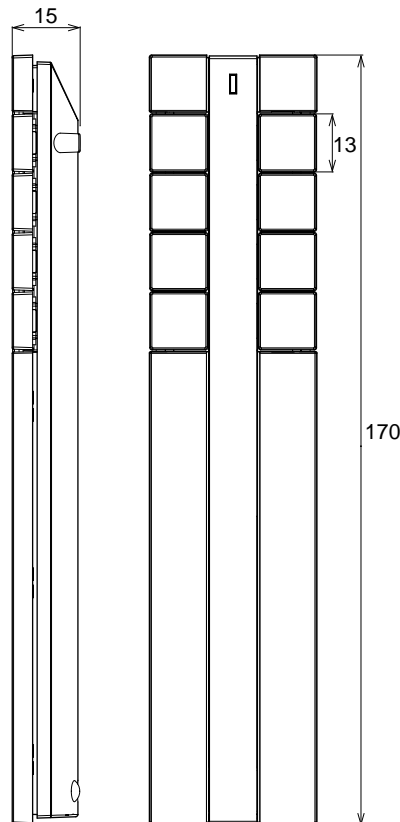

# Unica wireless

## Technical information

### Keyring remote control

#### CCT1A010

#### Area of application

- The Unica keyring remote control is mainly designed to remotely control the utilities in a bedroom or office. Each member of the family can have one to control the lights and roller blinds in their room.
- It can also be used to control the outdoor lighting, the garage door or the front gate of the house.

#### Technical data

- 4 channels which can be programmed in Simple or Scenario mode.
- Transmission frequency: 868 MHz.
- Transmission distance: up to 300 m outdoor and typically 10-50 m indoor (depending on the construction material).
- Battery: 3 V battery, CR2032 type (1 battery supplied).
- Battery life time: depends on use, usually between 5 and 7 years (approximately 20,000 operations at 20°C).
- Operating temperature: - 5 °C to +50 °C.
- Humidity: 20% - 95% without condensation.
- Protection class: IP 20.

#### Standards

In accordance with:

- EN 61000-6-2, EN 61001-6-3, IEC60068-2-6, IEC60068-2-27.
- ETS300220-1, ETS300220-2.
- EMC directive: 2004/108/EC.
- R&TTE directive: 99/5/EEC.

#### Advantages

- The keyring remote control is small enough to slip easily into a pocket.
- Its original, ergonomic design ensures that it is convenient and pleasant to use.
- Its metal ring allows it to fit onto a key ring.



#### Dimensions (mm)

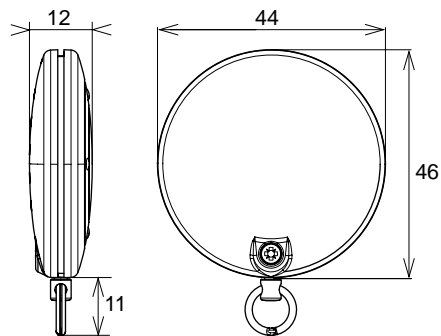

# Unica wireless

## Technical information

### Combined relays

#### MGU3.572.XX - 2300 W

### Area of application

- The Unica wireless combined relays contain both an emitter and a receiver.
- Each combined relay can replace an existing switch to control a lamp locally or remotely (via a battery-powered push-button or via the remote control).

### Technical data

- Rated voltage: 110-230 V AC  $\pm$  10 %, 50-60 Hz.
- Transmission frequency: 868 MHz.
- Transmission distance: up to 300 m outdoor and typically 10-50 m indoor (depending on the construction material).
- Protection: 10 A fuse.
- Operating temperature: - 5 °C to +50 °C.
- Humidity: 20% - 95% without condensation.
- Protection class: IP 20.

### Load table

| 25 °C<br>230 V<br>50 Hz<br>Max.<br>WVA | 1    | 2    | 3   | 4   | 5   | 6   | 7   |
|--|------|------|-----|-----|-----|-----|-----|
|  |      |      |     |     |     |     |     |
|  | 2300 | 2000 | 500 | 920 | 880 | 880 | 690 |

- 1 - Incandescent lamps
- 2 - Halogen lamps
- 3 - Low voltage halogen lamps with ferromagnetic transformer or with toroidal transformer or with electronic transformer
- 4 - Fluorescent tubes dia. 28 or 38 mm
- 5 - Compact fluorescent lamps
- 6 - LED lamps
- 7 - Motors and ventilators

### Standards

- In accordance with:
- EN 60669-1, EN 60669-2-1.
  - ETSI EN 300220, ETSI EN 301489.
  - EMC directive: 89/336/EEC.
  - LVD directive: 73/23/EEC.
  - R&TTE directive: 99/5/EEC.

### Symbols for scenarios

- When this product is used in a scenario mode, you can add symbols to match the function of the product.
- Set of 16 symbols for scenarios.
- Reference MGU0.570.XX.



### Advantages

- You can easily convert a wired one-way switch into a two-way switch. Just replace it with a combined relay and add one or more battery-operated push-buttons.
- You can choose to use the combined relays:
  - To control only the connected load, using the large cover (2 modules).
  - To control both the connected load and other Unica wireless receivers such as mobile socket-outlets, using the 2 narrow covers (2 x 1 module covers).

### Installation

- The combined relays can be installed:
  - In flush-mounted box at least 40 mm deep with an universal Unica fixing frame with or without claws.
  - In Unica surface-mounted boxes.



- The Unica wireless combined relay is supplied with:
  - 2 narrow covers (1 module covers).
  - 1 large cover (2 modules cover).
  - A set of 8 symbols to customize the covers ( 2 symbols «1/0» and 2 symbols «dimmer-up/dimmer-down»).

### Programming

Programming operation follows the same principles as described in the «Unica wireless system» part.

### Connections

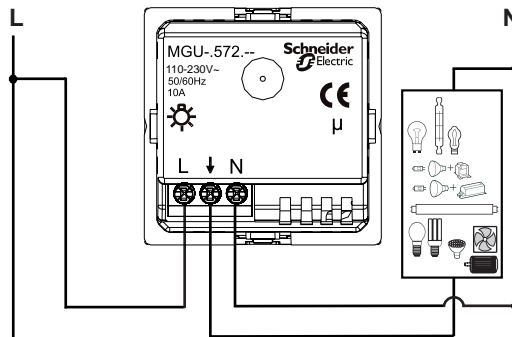

Connection terminals: screw connection for cables up to 2 x 2.5 mm<sup>2</sup>.

### Dimensions (mm)

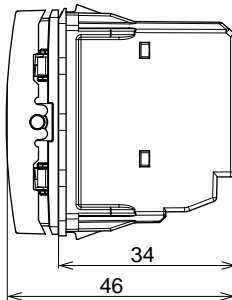

# Unica wireless

## Technical information

### Combined relays

#### MGU3.572.XX - 2300 W

### Area of application

- The Unica wireless combined dimmers contain both an emitter and a receiver.
- Each combined dimmer can replace an existing switch to control a lamp locally or remotely (via a battery-powered push-button or via the remote control).
- They allow to create soft lighting atmospheres and saving energy as they reduce the current supplying the load.

### Technical data

- Rated voltage: 230 V AC  $\pm$  10%, 50 Hz.
- Transmission frequency: 868 MHz.
- Transmission distance: up to 300 m outdoor and typically 10-50 m indoor (depending on the construction material).
- Protection: Electronic, protection against overloads, temperature rises, short-circuits and damage from inappropriate loads.
- Operating temperature: - 5 °C to +35 °C.
- Humidity: 20% - 95% without condensation.
- Protection class: IP 20.

### Load table

- Minimum load: 20 W.

|  |              |              |              |             |             |             |             |
|--|--------------|--------------|--------------|-------------|-------------|-------------|-------------|
| <br>25 °C<br>230 V<br>50 Hz<br>Max.<br>WVA | <br>1<br>315 | <br>2<br>315 | <br>3<br>270 | <br>4<br>NO | <br>5<br>NO | <br>6<br>NO | <br>7<br>NO |
|--|--------------|--------------|--------------|-------------|-------------|-------------|-------------|

- 1 - Incandescent lamps or halogen lamps
- 2 - Low voltage halogen lamps with ferromagnetic transformer or with electronic transformer
- 3 - Low voltage halogen lamps with toroidal transformer
- 4 - Fluorescent tubes dia. 28 or 38 mm
- 5 - Compact fluorescent lamps
- 6 - LED lamps
- 7 - Motors and ventilator

### Standards

- In accordance with:
- EN 60669-1, EN 60669-2-1, EN 61000-6-2, EN 61000-6-3.
  - ETSI EN 300220, ETSI EN 301489.
  - EMC directive: 89/336/EEC.
  - LVD directive: 73/23/EEC.
  - R&TTE directive: 99/5/EEC.

### Symbols for scenarios

- When this product is used in a scenario mode, you can add symbols to match the function of the product.
- Set of 16 symbols for scenarios.
- Reference MGU0.570.XX.



### Advantages

- You can easily convert a wired one-way switch into a two-way switch. Just replace it with a wireless combined dimmer and add one or more battery-operated push-buttons.
- You can choose to use the wireless combined dimmer:
  - To control only the connected load, using the large cover (2 modules).
  - To control both the connected load and other Unica wireless receivers such as mobile socket-outlets, using the 2 narrow covers (2 x 1 module covers).

### Installation

- The wireless combined dimmers can be installed:
  - In flush-mounted box at least 40 mm deep with an universal Unica fixing frame with or without claws.
  - In Unica surface-mounted boxes.



- The wireless combined dimmer is supplied with:
  - 2 narrow covers (1 module covers).
  - 1 large cover (2 modules cover).
  - A set of 8 symbols to customize the covers ( 2 symbols «1/0» and 2 symbols «dimmer-up/dimmer-down»).

### Programming

Programming operation follows the same principles as described in the «Unica wireless system» part.

### Connections

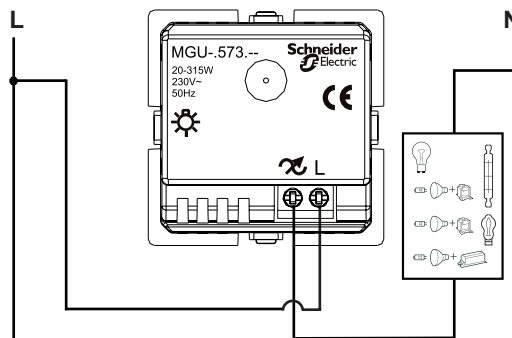

Connection terminals: screw connection for cables up to 2 x 2.5 mm<sup>2</sup>.

### Dimensions (mm)

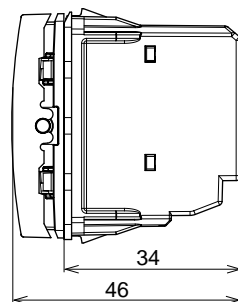

# Unica wireless

## Technical information

### Combined roller blinds

#### MGU3.574.XX

### Area of application

- The Unica wireless combined roller blinds are used to remotely control the opening and the closing of all the roller blinds in a room (or house).
- They are typically used to create centralisation of roller blinds without new wires or holes.

### Technical data

- Rated voltage: 110/230 V AC  $\pm 10\%$ , 50-60 Hz.
- Transmission frequency: 868 MHz.
- Transmission distance: up to 300 m outdoor and typically 10-50 m indoor (depending on the construction material).
- Protection: protection against one shot overload with thermal fuse and with main fuse 10 A.
- Operating temperature: - 5 °C to +50 °C.
- Humidity: 20% - 95% without condensation.
- Protection class: IP 20.
- Maximum load: 690 W, single phase tubular motors for roller blind (with or without limit switches).

### Standards

In accordance with:

- EN 60669-1, EN 60669-2-1.
- ETSI EN 300220, ETSI EN 301489.
- EMC directive: 89/336/EEC.
- R&TTE directive: 99/5/EEC.

### Symbols for scenarios

- When this product is used in a scenario mode, you can add symbols to match the function of the product.
- Set of 16 symbols for scenarios.
- Reference MGU0.570.XX.



### Advantages

- A centralised roller blinds control can be created without any rewiring and requires no repair work: no damaged walls, wallpaper, paint, etc. It can all be completed in just a few minutes, without any dust and without moving any furniture.
- Just replace each existing individual wired control with a Unica wireless combined roller blind module, then add Unica battery-powered push-button for centralised control in the required position.

### Installation

- The wireless combined roller blinds can replace an existing mechanical roller blinds control.
- You can choose to use the wireless combined roller blinds:
  - To control locally the connected roller blind, using the large cover (2 modules).
  - To control both; locally the connected roller blind and remotely other roller blinds, using the 2 narrow covers (2 x 1 module covers). Centralised control can therefore be created in just a few minutes.
- The combined roller blinds can be installed:
  - In flush-mounted box at least 40 mm deep with an universal Unica fixing frame with or without claws.
  - In Unica surface-mounted boxes.



- The wireless combined roller blind is supplied with:
  - 2 narrow covers (1 module covers).
  - 1 large cover (2 modules cover).
  - A set of 4 symbols to customize the covers (roller blind up / roller blind down and roller blind all-up/all-down).

### Programming

Programming operation follows the same principles as described in the «Unica wireless system» part.

### Connections

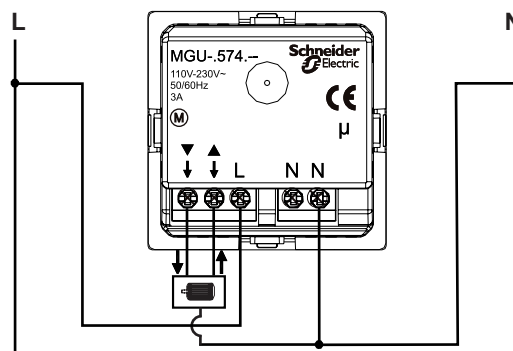

Connection terminals: screw connection for cables up to 2 x 2.5 mm<sup>2</sup>.

### Dimensions (mm)

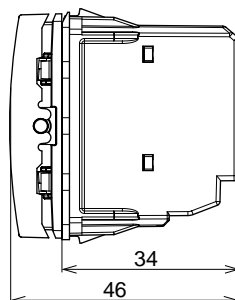

## Unica wireless

## Technical information

## Mobile socket-outlet relays

## CCT1A020 (german type) - CCT1A022 (french type)







## Area of application

- The Unica wireless mobile socket-outlet relays are used to remote control the lamps or devices connected to them.
- They can be linked with the other Unica wireless products by simple programming.
- They are appropriate for use with all standard sockets fitted at home.

## Technical data

- Rated voltage: 230 V AC  $\pm 10\%$ , 50 Hz.
- Transmission frequency: 868 MHz.
- Transmission distance: up to 300 m outdoor and typically 10-50 m indoor (depending on the construction material).
- Operating temperature: - 5 °C to +50 °C.
- Humidity: 20% - 95% without condensation.
- Protection class: IP 20.

## Load table

|   |  |  |  |  |  |  |
|---|--|--|--|--|--|--|
| <br>25 °C<br>230 V<br>50 Hz<br>Max.<br>WVA | <br>1<br>2300 | <br>2<br>1840 | <br>3<br>1840 | <br>4<br>1840 | <br>5<br>1840 | <br>6<br>1380 |
|---|--|--|--|--|--|--|

- 1 - Incandescent lamps or halogen lamps
- 2 - Low voltage halogen lamps with ferromagnetic transformer or with electronic transformers
- 3 - Fluorescent tubes dia. 28 or 38 mm
- 4 - Compact fluorescent lamps
- 5 - LED lamps
- 6 - Motors and ventilators

## Standards

- In accordance with:
- IEC 60669-1, IEC 60669-2-1, IEC 61000-6-2, IEC61000-6-3.
  - ETSI EN 300220, ETSI EN 301489.
  - EMC directive: 89/336/EEC.
  - LVD directive: 73/23/EEC.
  - R&TTE directive: 99/5/EEC.

## Advantages

- You can switch all the lamps connected to a socket on or off in one go.
- The lamps can be operated (switched on, off) locally via the key located on the mobile socket-outlet or remotely by using Unica battery-powered push-button or Unica remote controls.
- You can include your decorative lamps, halogen lamps, etc. in your Scenarios.

French type  
mobile socket-outlet relayGerman type  
mobile socket-outlet relay

Programming keys

## Programming

Programming operation follows the same principles as described in the «Unica wireless system» part.

## Dimensions (mm)

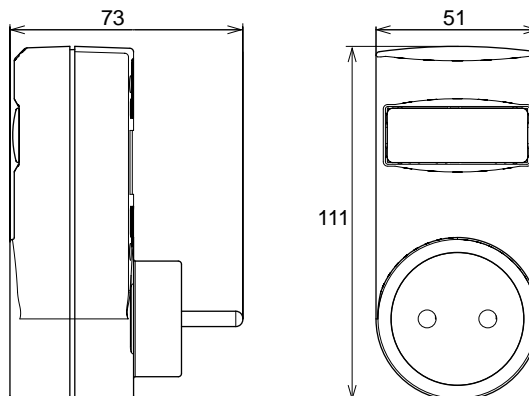

# Mobile socket-outlet dimmers

## CCT1A021 (german type) - CCT1A023 (french type)

### Area of application

- The Unica wireless mobile socket-outlet dimers are used to remote control the lamps or devices connected to them.
- They can be linked with the other Unica wireless products by simple programming.
- They are appropriate for use with all standard sockets fitted at home.
- They allow to create soft lighting atmospheres and saving energy as they reduce the current supplying the load.

### Technical data

- Rated voltage: 230 V AC  $\pm$  10%, 50 Hz.
- Transmission frequency: 868 MHz.
- Transmission distance: up to 300 m outdoor and typically 10-50 m indoor (depending on the construction material).
- Protection: electronic, against overloads, temperature rises, short-circuits and damage from inappropriate loads.
- Operating temperature: - 5 °C to +35 °C.
- Humidity: 20% - 95% without condensation.
- Protection class: IP 20.

### Load table

|   |              |              |             |             |             |             |
|---|--------------|--------------|-------------|-------------|-------------|-------------|
| <br>25 °C<br>230 V<br>50 Hz<br>Max. WVA | 1<br><br>250 | 2<br><br>250 | 3<br><br>NO | 4<br><br>NO | 5<br><br>NO | 6<br><br>NO |
|---|--------------|--------------|-------------|-------------|-------------|-------------|

- 1 - Incandescent lamps or halogen lamps
- 2 - Low voltage halogen lamps with ferromagnetic transformer or with electronic transformers
- 3 - Fluorescent tubes dia. 28 or 38 mm
- 4 - Compact fluorescent lamps
- 5 - LED lamps
- 6 - Motors and ventilators

### Standards

- In accordance with:
- IEC 60669-1, IEC 60669-2-1, IEC 61000-6-2, IEC61000-6-3.
  - ETSI EN 300220, ETSI EN 301489.
  - EMC directive: 89/336/EEC.
  - LVD directive: 73/23/EEC.
  - R&TTE directive: 99/5/EEC.

### Advantages

- You can switch all the lamps connected to a socket on or off in one go.
- The lamps can be operated (dimmed, switched on, off) locally via the key located on the mobile socket-outlet dimmer or remotely by using Unica battery-powered push-button or Unica remote controls.
- You can include your decorative lamps, halogen lamps, etc. in your Scenarios.



French type mobile socket-outlet dimmer



German type mobile socket-outlet dimmer



Programming keys

### Programming

Programming operation follows the same principles as described in the «Unica wireless system» part.

### Dimensions (mm)

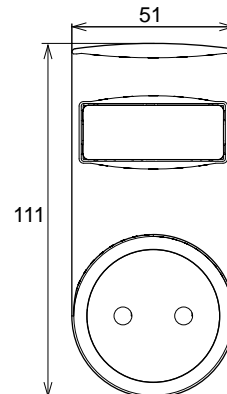
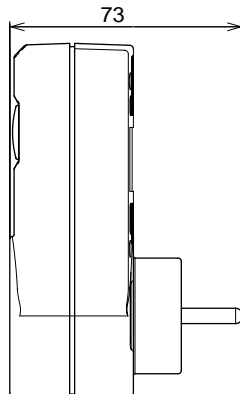



# Unica wireless

## Technical information

### Universal receiver relay

#### CCT1A031 - 2300 W

#### Area of application

The Unica wireless universal receiver relay is used to switch an electrical load (ceiling lamp, fan, etc.). It receives wireless control orders from wireless emitters or combined modules.

#### Technical data

- Rated voltage: 127/230 V AC  $\pm$  10%, 50/60 Hz.
- Transmission frequency: 868 MHz.
- Transmission distance: up to 100 m outdoor and typically 10-50 m indoor (depending on the construction material).
- Protection: protection against one shot overload with thermofuse and with main fuse 10 A.
- Operating temperature: - 5 °C to +50 °C.
- Humidity: 20% - 95% without condensation.
- Protection class: IP20.

#### Load table

Minimal load: 5 W.

| Icon                                   | 1    | 2    | 3   | 4   | 5   | 6   | 7   |
|--|------|------|-----|-----|-----|-----|-----|
| 25 °C<br>230 V<br>50 Hz<br>Max.<br>WVA |      |      |     |     |     |     |     |
|  | 2300 | 2000 | 500 | 920 | 880 | 880 | 690 |

- 1 - Incandescent lamps
- 2 - Halogen lamps
- 3 - Low voltage halogen lamps with ferromagnetic transformer or with toroidal transformer or with electronic transformers
- 4 - Fluorescent tubes dia. 28 or 38 mm
- 5 - Compact fluorescent lamps
- 6 - LED lamps
- 7 - Motors and ventilators

#### Standards

In accordance with:

- EN 60669-1, EN 60669-2-1, EN 61000-6-2, EN 61000-6-3.
- ETSI EN 300220, ETSI EN 301489.
- EMC directive: 89/336/EEC.
- R&TTE directive: 99/5/EEC.

#### Advantages

- The universal receiver allows all types of electrical appliances to be remotely controlled.
  - It can be hidden in the installation to preserve the aesthetic appearance of the room.
  - You can easily separate two lighting points to allow them to be controlled separately.
- Just fit a wireless universal receiver at each lighting point, then use Unica wireless products to control them such as; battery-powered push-button, universal emitter or remote control.
- It takes just a few moments to add an extra control point.

#### Installation

- The universal receiver can be mounted in various ways:
  - Flush-mounted in the ceiling in a box with a minimum depth of 40 mm.
  - Concealed in the base of a ceiling light. A hook can be passed through the hole in the centre to fix the lamp.
  - Concealed in a suspended ceiling.
  - In a flush wall-mounted box, behind a blanking plate.
- Metal surfaces near the receiver may affect reception.
- It is easy to program via the programming keys.
- It has no control button: it can only be remote controlled.

#### Connections

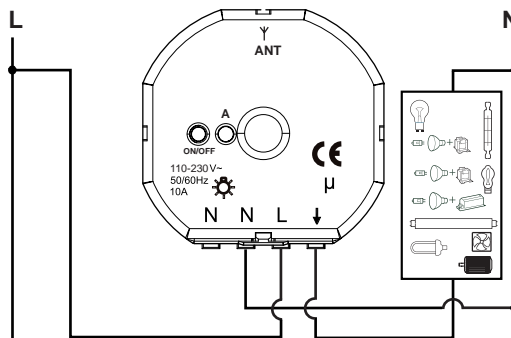

#### Dimensions (mm)

- H x W x D : 46 x 46 x 23 mm without cables.
- Cables length: 200 mm.

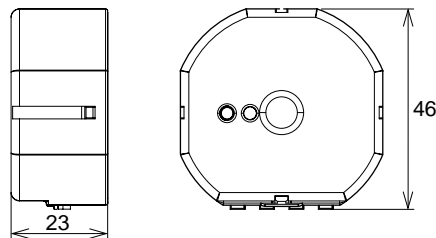

# Unica wireless

## Technical information

### Test kit

### CCT1A090

#### Area of application

The Unica wireless Test kit is used to test the transmission quality of the radio signal.

#### Technical data

- Transmission frequency: 868 MHz.
- Transmission distance: up to 300 m outdoor and typically 10-50 m indoor (depending on the construction material).
- Battery: 3 V battery, CR2032 type, supplied with 2 batteries (one for each testing device).
- Battery life time: depends on use, usually between 5 and 7 years (approximately 20,000 operations at 20°C).
- Operating temperature: - 5 °C to +50 °C.
- Humidity: 20% - 95% without condensation.
- Protection class: IP 20.

#### Standards

In accordance with:

- EN 61000-6-2, EN 61001-6-3.
- ETSI EN 300220, ETSI EN 301489.
- EMC directive: 89/336/EEC.
- R&TTE directive: 99/5/EEC.

#### Installation

- The Unica wireless test kit is supplied with 2 identical products to be used by pair (1 emitter, 1 receiver).
- Place the Unica test devices in the various rooms where the equipment is to be installed to check the quality of the radio signal link.



3 LED indicate the radio signal reception level (green, orange, red).

#### Dimensions (mm)

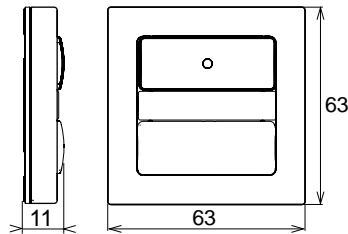

## Introduction

- The Unica wireless system is used for wireless control of lamps and other electrical equipment.
- The system consist of emitters, receivers and combined modules containing both emitters and receivers.
- The Unica wireless products can be programmed and thus linked with 2 different programming modes:
  - Simple mode programming.
  - Scenario mode programming.
- Each time you program a function between an emitter and a receiver you create a link. Unica wireless products can contain up to 32 links, except the combined modules which can contain up to 64 links.

## Simple mode

- "Simple mode" is used to link Unica wireless products for simple functions such as on/off, dim (for receivers with the dimmer function), open/close (for roller blinds). One or more emitters can be linked to one or more receivers.
- "Simple mode" is always used the 2 poles of a key:
  - Top to switch on/dim up/open.
  - Bottom to switch off/dim down/close.

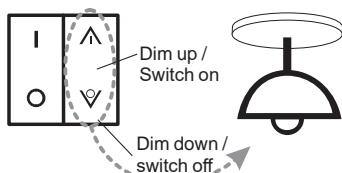

Example of "simple mode" for light dimming

The covers (2 modules or 2 x 1 module) have to be removed to access to the programming keys and the emitters have to be programmed before the receivers.

## Scenario mode

- The Unica wireless system can be programmed to remember various settings, called "Scenario mode". With a "Scenario mode" you get predefined lighting atmospheres with just one press of a key.
- "Scenario mode" is particularly useful when the receivers are designed as dimmers. A "Turn off all" function should be programmed into all "Scenario mode".
- With a "Scenario mode", each pole is independant and activates it's scenario.

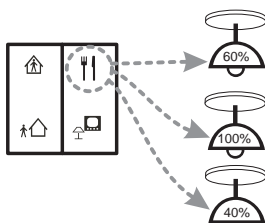

Example of "Scenario mode" for dinner

The covers (2 modules or 2 x 1 module) have to be removed to access to the programming keys and the emitters have to be programmed before the receivers.

## Emitter(s) programming

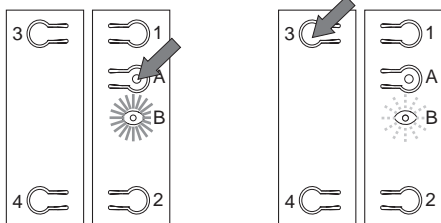

Start the programming by pressing the programming button **A** once. LED **B** lights up red.

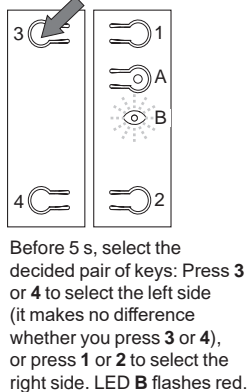

Before 5 s, select the decided pair of keys: Press **3** or **4** to select the left side (it makes no difference whether you press **3** or **4**), or press **1** or **2** to select the right side. LED **B** flashes red.

Repeat this operation on other emitter(s) if needed.

## Emitter(s) programming

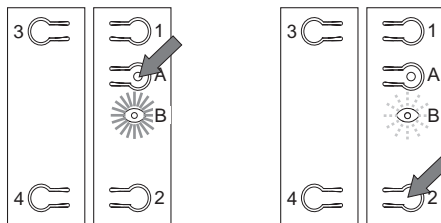

Start the programming by pressing the programming button **A** twice. LED **B** lights up green.

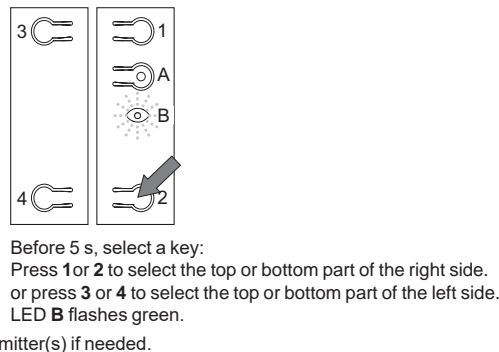

Before 5 s, select a key: Press **1** or **2** to select the top or bottom part of the right side. or press **3** or **4** to select the top or bottom part of the left side. LED **B** flashes green.

Repeat this operation on other emitter(s) if needed.

## Receiver(s) programming

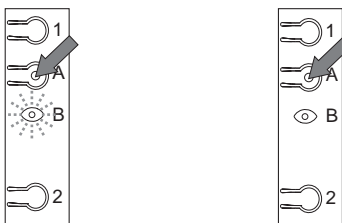

Select the receiver by pressing the programming button **A** once. Wait until LED **B** flashes red. (after 5 s with a combined module). Repeat this operation on other receiver(s) if needed.

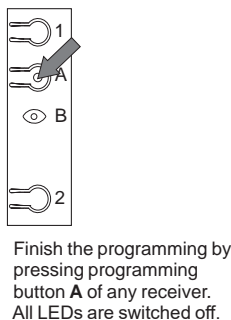

Finish the programming by pressing programming button **A** of any receiver. All LEDs are switched off.

## Receiver(s) programming

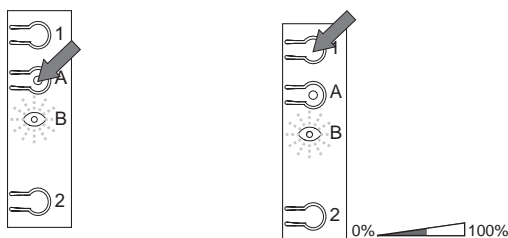

Select the receiver by pressing the programming button **A** once. Wait until LED **B** flashes green. (after 5 s with a combined module).

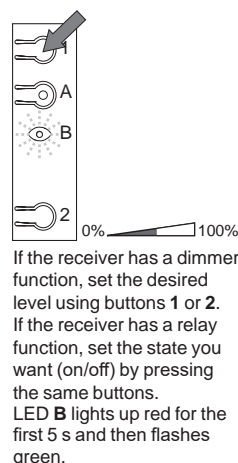

If the receiver has a dimmer function, set the desired level using buttons **1** or **2**. If the receiver has a relay function, set the state you want (on/off) by pressing the same buttons. LED **B** lights up red for the first 5 s and then flashes green.

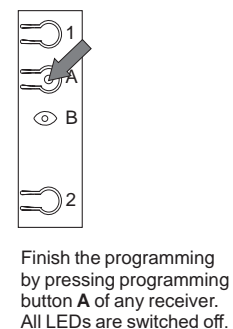

Finish the programming by pressing programming button **A** of any receiver. All LEDs are switched off.

Repeat this operation on other receiver(s) if needed.

## Programming examples (cont'd)

### "Simple mode" example

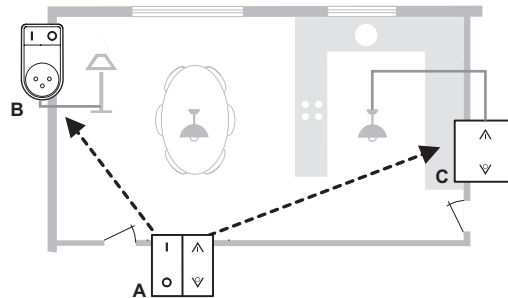

The battery-powered push-button **A** can control:

- With the left key, the lamp connected to the mobile socket-outlet **B**.
- With the right key, the ceiling lamp in the kitchen connected to the combined dimmer **C**.

### "Scenario mode" example

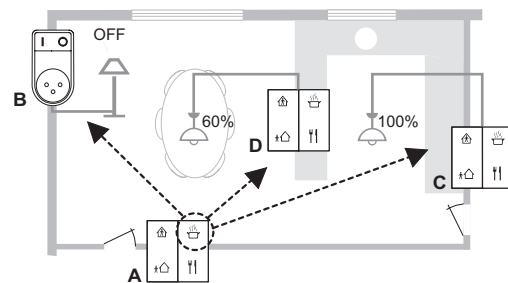

The battery-powered push-button **A** contain 4 Scenario programs.

When the family wants to prepare food, pressing the "food preparation" symbol will cause:

- The lamp connected to the mobile socket-outlet **B** to be turned off.
- The ceiling lamp above the dinning table connected to the combined dimmer **D** to be adjusted to 60%.
- The ceiling lamp in the kitchen connected to the combined dimmer **C** to be set to 100%.

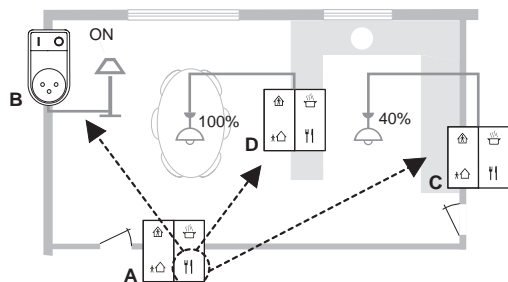

In the same way, pressing the "eating" symbol causes:

- The lamp connected to the mobile socket-outlet **B** to be switched on.
- The ceiling lamp above the dinning table connected to the combined dimmer **D** to be adjusted to 100%.
- The ceiling lamp in the kitchen connected to the combined dimmer **C** to be set to 40%.

Finally, when you press the "I'm home" symbol, all lamps are switched on at full strength; when you press the "I'm leaving" symbol, everything is switched off.



# Unica for KNX system



## Greater flexibility and comfort, better energy efficiency with KNX

More and more electronic appliances are needed for modern comfortable homes that contain everything from computers to home cinemas. Does this mean simply increase electricity consumption despite rising energy costs? A better, faster, cheaper and cleaner solution is to use energy more efficiently. This is not only better for the environment but for your wallet too.



# Intelligent and good looking home

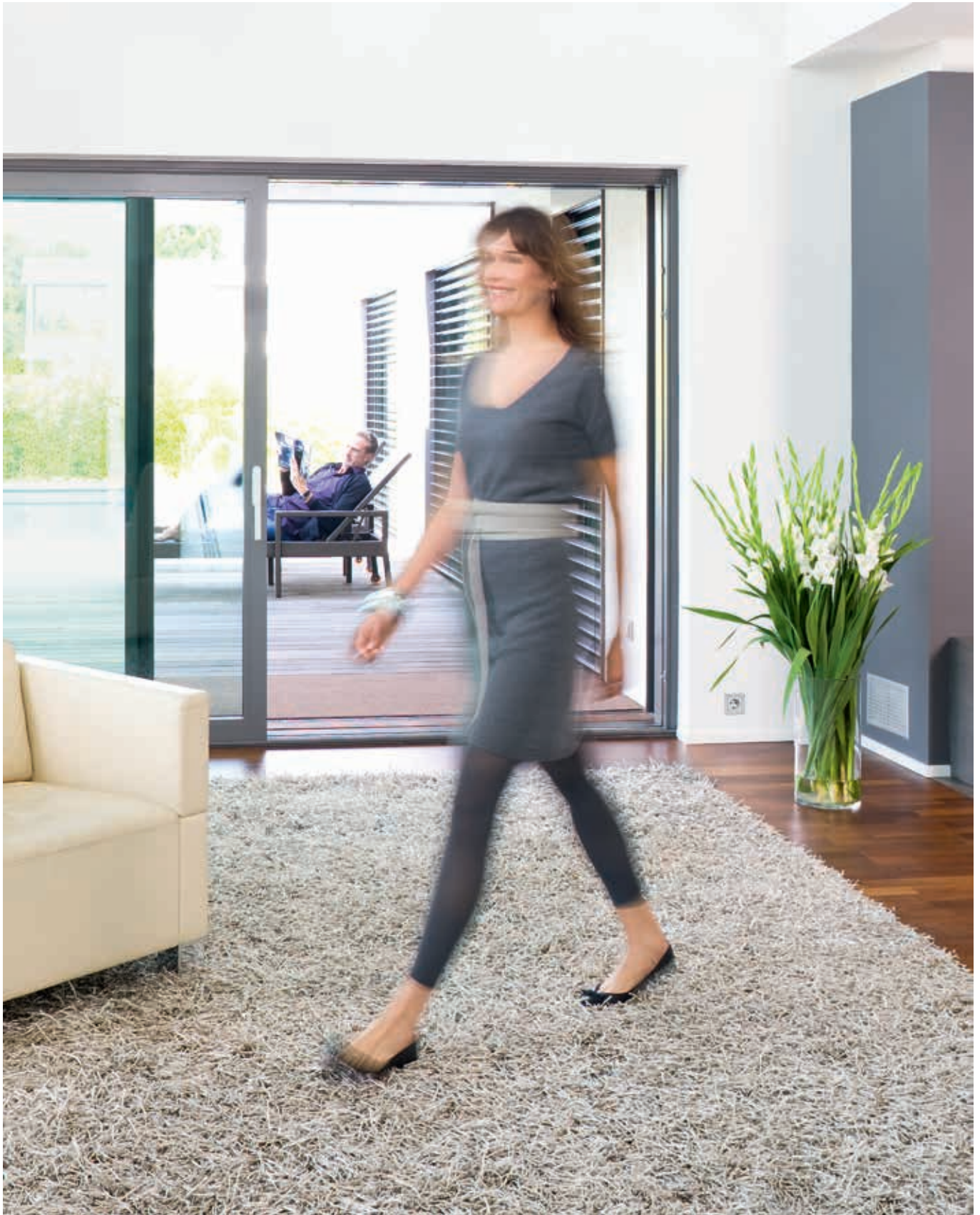



# Connect Unica to your KNX system!



Reading in your favourite armchair in the evening, watching TV on the sofa or dining with family or friends is all the more comfortable if you don't have to get up to switch each light, lamp or thermostat on or off individually.

By setting up individual scenes – for instance using a Unica multi-function push-button – you can combine a wide range of different functions. Once a scene has been created, it can be started at the push of a button – to create a suitable light mood when watching TV or reading for instance or when leaving the house in the morning. If, when doing so, you want the blinds to be raised, the lights switched off and heating turned down, you can activate the «Not at home» scene and all functions will be executed automatically.



#### Push-button

- Can be used to control lights or roller blinds.
- The system can be used to control lights and roller blinds according to the sunlight when coupled with a sensor.



#### IR push-button

- Can be used to control lights or roller blinds.
- Can be controlled by KNX IR remote control.



#### Automatic lighting control

- Can activate roller blinds or lights
- The system can be used to control lights and roller blinds according to movement detection in corridors, staircases.











#### Individual heating control

- Presence-dependent room heating.
  - Heat is supplied automatically at the exact time required and individually via controllable room temperature control units. No need to turn the radiators up and down manually.
- Don't worry: if you forget to do it, the KNX system will remember to do it for you.



Interested by the intelligent system? [See KNX catalog](#)

### Unica KNX range

| Product type  | Description  | Notes   | Range                           | Colour      | Reference          |
|---|--|---|---------------------------------|-------------|--------------------|
|    | Push-button, 2 buttons and 2 blue status LEDs, with screwless bus connecting terminals                       | The status LED is located under the symbol window which can be taken off.   | Class, Top                      | ■ aluminium | <b>MGU3.530.30</b> |
|   |  |   |                                 | ■ graphite  | <b>MGU3.530.12</b> |
|    | Push-button, 4 buttons and 4 blue status LEDs, with screwless bus connecting terminals                       | The status LED is located under the symbol window which can be taken off.   | Class, Top                      | ■ aluminium | <b>MGU3.531.30</b> |
|   |  |   |                                 | ■ graphite  | <b>MGU3.531.12</b> |
|    | Push-button, 2 buttons, blue status LED and Infra Red (IR) receiver, with screwless bus connecting terminals | The status LED is located under the symbol window which can be taken off. The functions of each of the button can be triggered using an IR remote control. The push-button is pre-programmed for operation with a Schneider Electric IR remote control Distance. Many other IR remote controls (e.g. existing TV or CD player remote controls) can be taught into the push-buttons. | Class, Top                      | ■ aluminium | <b>MGU3.532.30</b> |
|   |  |   |                                 | ■ graphite  | <b>MGU3.532.12</b> |
|    | Infra Red (IR) remote control for IR push-button receiver  |   | Class, Top, Plus, Colors, Basic | □ white     | <b>MGU3.532.18</b> |
|   |  |   |                                 | ■ ivory     | <b>MGU3.532.25</b> |
|  | Movement detector  |   | Class, Top                      | ■ aluminium | <b>MGU3.533.30</b> |
|   |  |   |                                 | ■ graphite  | <b>MGU3.533.12</b> |
|  | Room temperature control unit  |   | Plus, Colors, Basic             | □ white     | <b>MGU3.533.18</b> |
|   |  |   |                                 | ■ ivory     | <b>MGU3.533.25</b> |
|  | Room temperature control unit  |   | Class, Top                      | ■ aluminium | <b>MGU3.534.30</b> |
|   |  |   |                                 | ■ graphite  | <b>MGU3.534.12</b> |
|  | Room temperature control unit  |   | Plus, Colors, Basic             | □ white     | <b>MGU3.534.18</b> |
|   |  |   |                                 | ■ ivory     | <b>MGU3.534.25</b> |

### Detailed presentation of the range

Unica Class, Unica Top: see page 57.

Unica Plus, Unica Colors, Unica Basic: see page 112.

# Unica KNX

## Technical information

### Push-buttons

Depending on the push-button, you have either two or four operating surfaces available to which you assign different functions via the ETS.

For example, you can:

- Switch and toggle
- Dimming
- Control blinds
- Save and retrieve scenes
- Call up linear regulator functions
- Save edge functions

If required, you can disable the buttons and define the type of disabling.

The push-button with an IR receiver will allow you to operate each push-button by IR remote control as well.

#### Technical data

- Power supply: DC 24 V
- KNX connection: bus connecting terminal
- Display elements:
  - Status LEDs
  - 1 programming LED
- Operating elements:
  - Control keys
  - 1 programming button
- Ambient operating temperature: -5 °C to +45 °C
- IR receiver:
  - Angle of reception: approx. 60°
  - Reception range: Dependent on the IR remote control used
- IR channels: 9
- Type of protection: IP 20
- Initialisation: The device is ready for operation after 5 to 10 seconds.

#### Software functions

- Switching, toggling
- Dimming (single/dual-surface)
- Blind (single/dual-surface)
- Pulse edges trigger 1-, 2-, 4- or 8-bit telegrams (distinction between short and long operation)
- Pulse edges with 2-byte telegrams (distinction between short and long operation)
- 8-bit linear regulator
- Scene retrieval
- Scene saving
- Disable functions.

#### Connections, displays and operating elements

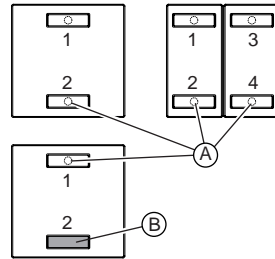

- (A) Status LEDs
- (B) IR receiver (no status LED)
- 1-4: Button assignment in the ETS

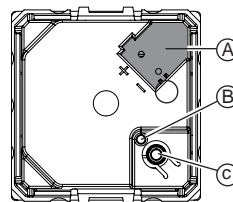

- (A) Bus connection
- (B) Programming LED
- (C) Programming button

#### Dimensions

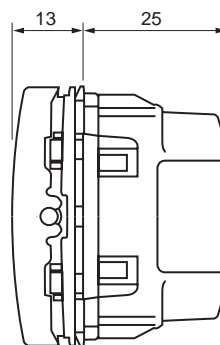

# Unica KNX

## Technical information

### Movement detector

#### Area of application

- Movement detector for indoors.
- The movement detector detects moving heat sources, (e.g. people), within a radius of 180° and up to a distance of approx. 9 m at an mounting height of 2.15 m.
- The range refers to average conditions for the specified mounting height and is therefore a guide value. The range and sensitivity can vary greatly when the temperature fluctuates.
- When a movement is detected, a defined data telegram is transmitted. The rotary switch for detection brightness is used to regulate from which ambient brightness level at which movements should be detected. Here, values between 10 and 1000 lux are possible (in the ETS value from 10 to 2000 lux are possible). The range and the overshoot time can be set at two further rotary switches.
- The movement detector also has two movement sensors. You can set their sensitivity and range sector-specifically in the ETS.
- The movement detector has an integrated bus coupler and its power is supplied via KNX.

#### Technical data

- Angle of detection: 180°
- Number of movement sensors: 2, sector-orientated, adjustable (ETS)
- Recommended mounting height: 1 m to 2,5 m
- Range: at 2.15 m mounting height, approx. 9 m on all sides, adjustable in 10 steps (rotary switch or ETS)
- Detection brightness: infinite setting from approx. 10 lux to approx. 1000 lux (rotary switch) or from 10 lux to 2000 lux (ETS)
- Overshoot time: adjustable in 6 steps from approx. 1 s to approx. 8 min (rotary switch) or adjustable from 1 s to 255 hours (ETS)

#### Standards

**EC guidelines:** Low-voltage guideline 2006/95/EEC and EMC guideline 2004/108/EC.

#### Software functions

Five movement blocks: up to four functions can be triggered per block. Telegrams: 1 bit, 1 byte, 2 bytes.  
Normal operation and surveillance operation, master, slave, safety pause, disable function. Sensitivity, brightness and staircase timer can be set using the ETS or the potentiometer.  
Two movement sensors: the sensitivity and range can be set separately for each sensor. Self-adjusting staircase timer.

#### Dimensions

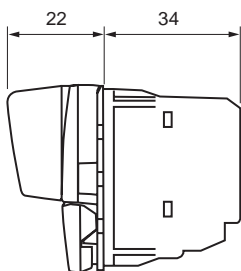

#### Connections, displays and operating elements

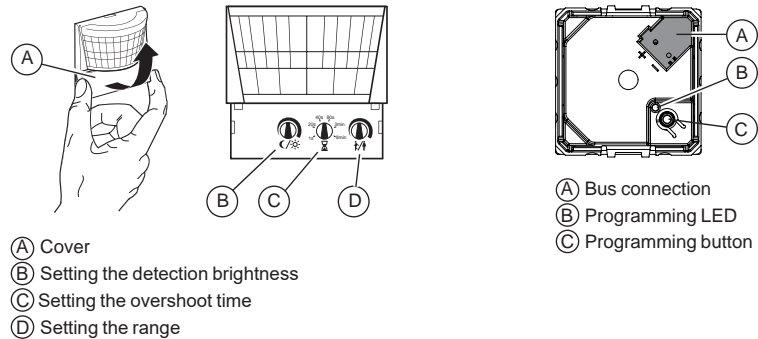

#### Use

- Observe the area of detection: Any mounting height which deviates from this will affect the range.

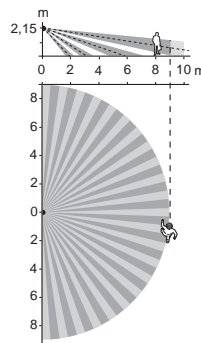

- Install the movement detector laterally with respect to the direction of movement so that the beam paths are intersected as vertically as possible.
- Only mount the movement detector in positions which allow the required area to be monitored optimally.

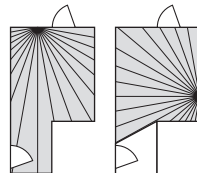

- In order to ensure continuous monitoring, e.g. of a long hall, the areas of detection have to intersect.
- Movement detectors can detect all objects that radiate heat. You should select an installation site that will not result in undesired heat sources being detected, such as:
  - switched-on lights in the area of detection
  - open fires (such as in fireplaces)
  - windows where the influence of alternating sunlight and clouds could cause rapid changes in temperature.
  - larger heat sources (e.g. cars), that are detected through windows.
  - sunlit rooms with reflecting objects (e.g. the floor), which can be the cause of rapid changes in temperature.
  - windowpanes heated up by sunlight
  - dogs, cats, etc.
- Install movement detectors in a wind-resistant switch box: With switch boxes and pipe cabling systems, a draught at the back of the equipment could trigger the movement detector.
- Avoid direct sunlight. This can destroy the sensor in extreme cases.

# KNX room temperature control unit

## Area of application

The Room temperature control unit with display (referred to as Controller from here on) can be used for heating and cooling with infinitely variable KNX valve drives or for controlling switch actuators and heating actuators.

## Technical data

- Power supply: via KNX
- Power consumption: approx. 9 mA
- Connection: bus connecting terminal
- Display elements: 1x display
- Operating elements: 4 push-buttons
- Measuring range: 0 to 40 °C
- Measuring accuracy:  $\pm 1$  K, depending on installation site; offset can be parameterised
- Operating temperature: -5°C to +45°C
- Controller type:
  - 2-step
  - Continuous PI controller
  - Switching PI controller (PWM)
- Controller mode:
  - heating with 1 controller output
  - Cooling with 1 controller output
  - Heating and cooling with separate controller outputs
  - 2-step heating with 2 controller outputs
  - 2-step cooling with 2 controller outputs
  - 2 controller outputs
- Type of protection: IP 20
- EC guidelines:
  - Low-voltage guideline 2006/95/EEC
  - EMC directive 2004/108/EEC

## Software functions

### Functions of the room temperature control unit:

- Controller type: 2-step control, continuous PI controller, switching PI controller (PWM)
- Output: continuous in the range 0 to 100% or switching ON/OFF
- Controller mode:
  - Heating with one controller output
  - Cooling with one controller output
  - Heating and cooling with separate controller outputs
  - Heating and cooling with one controller output
  - 2-step heating with 2 control outputs
  - 2-step cooling with 2 control outputs
  - 2-step heating and cooling with 4 control outputs
- Operating modes: Comfort, comfort extension, standby, night reduction, frost/heat protection
- Move all setpoints, save all setpoint temperatures and operating modes when reset, external temperature monitoring, additional output of the control value as 1 byte value on the PWM.
- Monitoring function for the actual temperature, valve protection function.

### Functions of the push-buttons:

Selection of 1-4 operating modes each push-button. Move setpoint.

## Dimensions

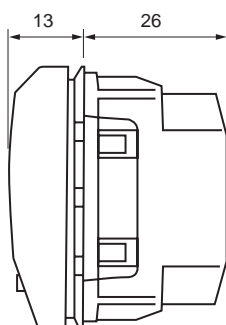

## Use

KNX Room temperature control unit with display and 4 buttons. 2 buttons allow to shift set values and change operation modes, the other 2 buttons are used for navigation in the menu. The room temperature control unit can be used for heating and cooling with infinitely adjustable KNX valve drives or to trigger switch actuators and heating actuators. With the white backlit display for showing e.g. the time, date, temperature and operating mode. Menu for setting default operating modes, setpoint value, working/non-working day (external trigger), display mode, time, switching times and brightness of the display.

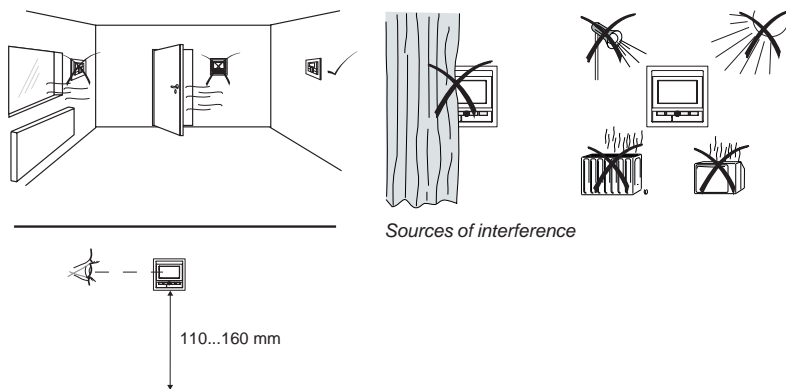

## Connections, displays and operating elements

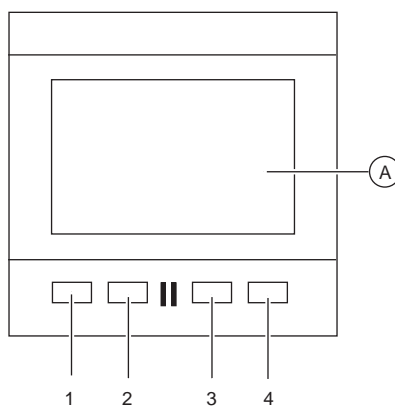

1 + 4: Menu navigation push-buttons

2 + 3: Push-buttons

(A) Display

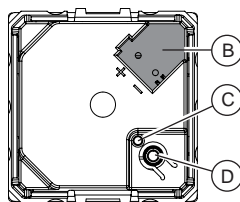

(B) Bus connection

(C) Programming LED

(D) Programming button

# Reference number overview

| Ref          | page | Ref           | page | Ref           | page | Ref           | page | Ref            | page |
|--------------|------|---------------|------|---------------|------|---------------|------|----------------|------|
| CCT1A000     | 58   | MGU2.801.55   | 137  | MGU3.041.30   | 45   | MGU3.105.25   | 86   | MGU3.163.25S   | 87   |
| CCT1A000     | 115  | MGU2.801.57   | 137  | MGU3.043.18   | 99   | MGU3.105.25N  | 87   | MGU3.163.30    | 32   |
| CCT1A010     | 58   | MGU2.802.18   | 137  | MGU3.045.12   | 44   | MGU3.105.30   | 32   | MGU3.163.30N   | 33   |
| CCT1A010     | 115  | MGU2.802.25   | 137  | MGU3.045.18   | 98   | MGU3.105.30N  | 33   | MGU3.163.30S   | 33   |
| CCT1A020     | 57   | MGU2.802.55   | 137  | MGU3.045.25   | 98   | MGU3.105T.18  | 86   | MGU3.201.12    | 32   |
| CCT1A020     | 114  | MGU2.802.57   | 137  | MGU3.045.30   | 44   | MGU3.105T.18N | 87   | MGU3.201.12N   | 33   |
| CCT1A021     | 57   | MGU2.803.18   | 137  | MGU3.046.18   | 98   | MGU3.105T.30N | 33   | MGU3.201.12S   | 33   |
| CCT1A021     | 114  | MGU2.803.25   | 137  | MGU3.046.30   | 44   | MGU3.106.12   | 34   | MGU3.201.18N   | 87   |
| CCT1A022     | 57   | MGU2.803.55   | 137  | MGU3.047.03   | 45   | MGU3.106.12C  | 34   | MGU3.201.18S   | 87   |
| CCT1A022     | 114  | MGU2.803.57   | 137  | MGU3.047.03   | 99   | MGU3.106.12CN | 34   | MGU3.201.25    | 86   |
| CCT1A023     | 57   | MGU2.804.18   | 137  | MGU3.047.12   | 45   | MGU3.106.12L  | 34   | MGU3.201.25N   | 87   |
| CCT1A023     | 114  | MGU2.804.25   | 137  | MGU3.047.18   | 99   | MGU3.106.12LN | 34   | MGU3.201.25S   | 87   |
| CCT1A030     | 58   | MGU2.804.55   | 137  | MGU3.047.25   | 99   | MGU3.106.12N  | 34   | MGU3.201.30    | 32   |
| CCT1A030     | 115  | MGU2.804.57   | 137  | MGU3.047.30   | 45   | MGU3.106.18   | 88   | MGU3.201.30N   | 33   |
| CCT1A031     | 58   | MGU2.806.18   | 137  | MGU3.048.18   | 99   | MGU3.106.18C  | 88   | MGU3.201.30S   | 33   |
| CCT1A031     | 115  | MGU2.806.25   | 137  | MGU3.048.30   | 45   | MGU3.106.18CN | 88   | MGU3.201.30N   | 33   |
| CCT1A090     | 58   | MGU2.806.55   | 137  | MGU3.057.03   | 43   | MGU3.106.18L  | 88   | MGU3.201T.12N  | 33   |
| CCT1A090     | 115  | MGU2.806.57   | 137  | MGU3.057.03   | 97   | MGU3.106.18LN | 88   | MGU3.201T.18   | 86   |
| ENN35303     | 119  | MGU3.020.18   | 99   | MGU3.057.03SL | 43   | MGU3.106.18N  | 88   | MGU3.201T.18N  | 87   |
| ENN37303     | 119  | MGU3.020.25   | 99   | MGU3.057.03SL | 97   | MGU3.106.25   | 88   | MGU3.201T.25   | 86   |
| MGU0.570.12  | 58   | MGU3.021.12   | 45   | MGU3.057.06   | 43   | MGU3.106.25C  | 88   | MGU3.201T.30N  | 33   |
| MGU0.570.18  | 115  | MGU3.021.18   | 99   | MGU3.057.06   | 97   | MGU3.106.25CN | 88   | MGU3.203.12    | 32   |
| MGU0.570.25  | 115  | MGU3.021.25   | 99   | MGU3.057.12   | 43   | MGU3.106.25L  | 88   | MGU3.203.12N   | 33   |
| MGU0.570.30  | 58   | MGU3.021.30   | 45   | MGU3.057.12TA | 43   | MGU3.106.25LN | 88   | MGU3.203.12S   | 33   |
| MGU0.821     | 51   | MGU3.023.12   | 44   | MGU3.057.18   | 97   | MGU3.106.25N  | 88   | MGU3.203.12VMC | 36   |
| MGU0.821     | 108  | MGU3.023.18   | 98   | MGU3.057.18SL | 97   | MGU3.106.30   | 34   | MGU3.203.18    | 86   |
| MGU0.822.AL  | 35   | MGU3.023.25   | 98   | MGU3.057.18TA | 97   | MGU3.106.30C  | 34   | MGU3.203.18N   | 87   |
| MGU0.822.AL  | 89   | MGU3.023.30   | 44   | MGU3.057.25   | 97   | MGU3.106.30CN | 34   | MGU3.203.18S   | 87   |
| MGU0.822.AZL | 35   | MGU3.027.18   | 100  | MGU3.057.25TA | 97   | MGU3.106.30L  | 34   | MGU3.203.18VMC | 90   |
| MGU0.822.AZL | 89   | MGU3.027.25   | 100  | MGU3.057.30   | 43   | MGU3.106.30LN | 34   | MGU3.203.25    | 86   |
| MGU0.823.AM  | 35   | MGU3.028.12   | 46   | MGU3.057.30SL | 43   | MGU3.106.30N  | 34   | MGU3.203.25N   | 87   |
| MGU0.823.AM  | 89   | MGU3.028.18   | 100  | MGU3.057.30TA | 43   | MGU3.106.30N  | 34   | MGU3.203.25S   | 87   |
| MGU0.824     | 42   | MGU3.028.30   | 46   | MGU3.059.03   | 98   | MGU3.106T.12  | 34   | MGU3.203.30    | 32   |
| MGU0.824     | 96   | MGU3.030.12   | 44   | MGU3.059.03SL | 44   | MGU3.106T.12N | 34   | MGU3.203.30N   | 33   |
| MGU0.825.AL  | 35   | MGU3.030.18   | 98   | MGU3.059.12   | 44   | MGU3.106T.18  | 88   | MGU3.203.30S   | 33   |
| MGU0.825.AL  | 89   | MGU3.030.30   | 44   | MGU3.059.18   | 98   | MGU3.106T.18N | 88   | MGU3.203.30VMC | 36   |
| MGU0.825.AZL | 35   | MGU3.031.12   | 45   | MGU3.059.25   | 98   | MGU3.106T.25  | 88   | MGU3.203T.18   | 86   |
| MGU0.825.AZL | 89   | MGU3.031.18   | 99   | MGU3.059.25   | 98   | MGU3.106T.25N | 88   | MGU3.203T.30   | 32   |
| MGU0.839.12  | 46   | MGU3.031.25   | 99   | MGU3.059.30   | 44   | MGU3.106T.30  | 34   | MGU3.205.12    | 32   |
| MGU0.839.18  | 100  | MGU3.031.30   | 45   | MGU3.061.12   | 46   | MGU3.106T.30N | 34   | MGU3.205.12N   | 33   |
| MGU0.839.30  | 46   | MGU3.033.12   | 45   | MGU3.061.18   | 100  | MGU3.107T.12  | 36   | MGU3.205.18    | 86   |
| MGU2.002.18  | 152  | MGU3.033.18   | 99   | MGU3.061.25   | 100  | MGU3.107T.18  | 90   | MGU3.205.18N   | 87   |
| MGU2.002.18M | 152  | MGU3.033.25   | 99   | MGU3.061.30   | 46   | MGU3.107T.25  | 90   | MGU3.205.25    | 86   |
| MGU2.002.25  | 152  | MGU3.033.30   | 45   | MGU3.068.18   | 99   | MGU3.107T.30  | 36   | MGU3.205.25N   | 87   |
| MGU2.002.25M | 152  | MGU3.036.12   | 43   | MGU3.068.30   | 45   | MGU3.108T.12  | 36   | MGU3.205.30    | 32   |
| MGU2.002.559 | 152  | MGU3.036.18   | 97   | MGU3.077.12   | 45   | MGU3.108T.18  | 90   | MGU3.205.30N   | 33   |
| MGU2.002.858 | 152  | MGU3.036.25   | 97   | MGU3.077.18   | 99   | MGU3.108T.25  | 90   | MGU3.205.30S   | 33   |
| MGU2.002.859 | 152  | MGU3.036.30   | 43   | MGU3.077.25   | 99   | MGU3.108T.30  | 36   | MGU3.205T.30   | 32   |
| MGU2.004.18  | 152  | MGU3.037.03   | 43   | MGU3.077.30   | 45   | MGU3.108T.30  | 36   | MGU3.206.12    | 34   |
| MGU2.004.25  | 152  | MGU3.037.03   | 97   | MGU3.101.12   | 32   | MGU3.109T.12  | 36   | MGU3.206.12C   | 34   |
| MGU2.004.559 | 152  | MGU3.037.03SL | 43   | MGU3.101.12N  | 33   | MGU3.109T.18  | 90   | MGU3.206.12CN  | 34   |
| MGU2.004.858 | 152  | MGU3.037.03SL | 97   | MGU3.101.18   | 86   | MGU3.109T.25  | 90   | MGU3.206.12L   | 34   |
| MGU2.004.859 | 152  | MGU3.037.06   | 43   | MGU3.101.18N  | 87   | MGU3.109T.30  | 36   | MGU3.206.12LN  | 34   |
| MGU2.006.18  | 152  | MGU3.037.06   | 97   | MGU3.101.18S  | 87   | MGU3.127T.12  | 36   | MGU3.206.12N   | 34   |
| MGU2.006.25  | 152  | MGU3.037.12   | 43   | MGU3.101.25   | 86   | MGU3.127T.30  | 36   | MGU3.206.18    | 88   |
| MGU2.006.559 | 152  | MGU3.037.12SL | 43   | MGU3.101.25N  | 87   | MGU3.136.12   | 34   | MGU3.206.18C   | 88   |
| MGU2.006.858 | 152  | MGU3.037.12TA | 43   | MGU3.101.25S  | 87   | MGU3.136.18   | 88   | MGU3.206.18CN  | 88   |
| MGU2.006.859 | 152  | MGU3.037.18   | 97   | MGU3.101.30   | 32   | MGU3.136.25   | 88   | MGU3.206.18L   | 88   |
| MGU2.008.18  | 152  | MGU3.037.18SL | 97   | MGU3.101.30N  | 33   | MGU3.136.30   | 34   | MGU3.206.18L   | 88   |
| MGU2.008.25  | 152  | MGU3.037.18TA | 97   | MGU3.101T.18  | 86   | MGU3.161.12   | 32   | MGU3.206.18LN  | 88   |
| MGU2.008.559 | 152  | MGU3.037.25   | 97   | MGU3.101T.18N | 87   | MGU3.161.12N  | 33   | MGU3.206.18N   | 88   |
| MGU2.008.858 | 152  | MGU3.037.25SL | 97   | MGU3.101T.30  | 32   | MGU3.161.12S  | 33   | MGU3.206.25    | 88   |
| MGU2.008.859 | 152  | MGU3.037.25TA | 97   | MGU3.101T.30N | 33   | MGU3.161.12S  | 86   | MGU3.206.25C   | 88   |
| MGU2.010.18  | 152  | MGU3.037.30   | 43   | MGU3.103.12   | 32   | MGU3.161.18   | 86   | MGU3.206.25CN  | 88   |
| MGU2.010.25  | 152  | MGU3.037.30SL | 43   | MGU3.103.18   | 86   | MGU3.161.18N  | 87   | MGU3.206.25L   | 88   |
| MGU2.502.18  | 149  | MGU3.037.30TA | 43   | MGU3.103.18N  | 87   | MGU3.161.18S  | 87   | MGU3.206.25LN  | 88   |
| MGU2.702.16  | 136  | MGU3.037.61   | 43   | MGU3.103.18S  | 87   | MGU3.161.25   | 86   | MGU3.206.25N   | 88   |
| MGU2.702.17  | 136  | MGU3.039.03   | 98   | MGU3.103.25   | 86   | MGU3.161.25N  | 87   | MGU3.206.30    | 34   |
| MGU2.702.18  | 136  | MGU3.039.03SL | 44   | MGU3.103.25N  | 87   | MGU3.161.25N  | 87   | MGU3.206.30C   | 34   |
| MGU2.702.25  | 136  | MGU3.039.03SL | 98   | MGU3.103.25S  | 87   | MGU3.161.25S  | 87   | MGU3.206.30CN  | 34   |
| MGU2.704.16  | 136  | MGU3.039.12   | 44   | MGU3.103.30   | 32   | MGU3.161.30   | 32   | MGU3.206.30LN  | 34   |
| MGU2.704.18  | 136  | MGU3.039.12SL | 44   | MGU3.103.30N  | 33   | MGU3.161.30N  | 33   | MGU3.206.30L   | 34   |
| MGU2.704.25  | 136  | MGU3.039.18   | 98   | MGU3.103.30S  | 33   | MGU3.161.30S  | 33   | MGU3.206.30LN  | 34   |
| MGU2.706.16  | 136  | MGU3.039.18SL | 98   | MGU3.103T.12N | 33   | MGU3.162.12   | 32   | MGU3.206.30N   | 34   |
| MGU2.706.17  | 136  | MGU3.039.25   | 98   | MGU3.103T.18  | 86   | MGU3.162.12S  | 33   | MGU3.206.30S   | 33   |
| MGU2.706.18  | 136  | MGU3.039.25   | 98   | MGU3.103T.18N | 87   | MGU3.162.18   | 86   | MGU3.206T.18   | 88   |
| MGU2.706.25  | 136  | MGU3.039.30   | 44   | MGU3.103T.25  | 86   | MGU3.162.18S  | 87   | MGU3.206T.18N  | 88   |
| MGU2.708.16  | 136  | MGU3.039.30SL | 44   | MGU3.103T.30  | 32   | MGU3.162.25   | 86   | MGU3.206T.30N  | 34   |
| MGU2.708.17  | 136  | MGU3.040.18   | 97   | MGU3.105.12   | 32   | MGU3.162.25S  | 87   | MGU3.207.12    | 36   |
| MGU2.708.18  | 136  | MGU3.040.25   | 97   | MGU3.105.12N  | 33   | MGU3.162.30S  | 33   | MGU3.207.18    | 90   |
| MGU2.708.25  | 136  | MGU3.041.12   | 45   | MGU3.105.18   | 86   | MGU3.163.12   | 32   | MGU3.207.25    | 90   |
| MGU2.801.18  | 137  | MGU3.041.18   | 99   | MGU3.105.18N  | 87   | MGU3.163.12N  | 33   | MGU3.207.30    | 36   |
| MGU2.801.25  | 137  | MGU3.041.25   | 99   |               |      | MGU3.163.12S  | 33   | MGU3.207T.12   | 90   |
|              |      |               |      |               |      | MGU3.163.18   | 86   | MGU3.208.12    | 36   |
|              |      |               |      |               |      | MGU3.163.18N  | 87   | MGU3.208.18    | 90   |
|              |      |               |      |               |      | MGU3.163.18S  | 87   | MGU3.208.25    | 90   |
|              |      |               |      |               |      | MGU3.163.25   | 86   | MGU3.208.30    | 36   |
|              |      |               |      |               |      | MGU3.163.25N  | 87   | MGU3.208T.18   | 90   |
|              |      |               |      |               |      |               |      | MGU3.211.12    | 32   |

## Reference number overview

| Ref            | page | Ref         | page | Ref         | page | Ref         | page | Ref           | page |
|----------------|------|-------------|------|-------------|------|-------------|------|---------------|------|
| MGU3.211.18    | 86   | MGU3.411.25 | 104  | MGU3.444.12 | 47   | MGU3.490.18 | 108  | MGU3.535.18   | 95   |
| MGU3.211.25    | 86   | MGU3.411.30 | 47   | MGU3.444.18 | 104  | MGU3.490.25 | 108  | MGU3.535.25   | 95   |
| MGU3.211.30    | 32   | MGU3.412.12 | 47   | MGU3.444.25 | 104  | MGU3.490.30 | 51   | MGU3.535.30   | 41   |
| MGU3.213.12    | 32   | MGU3.412.18 | 104  | MGU3.444.30 | 47   | MGU3.491.12 | 51   | MGU3.540.12   | 42   |
| MGU3.213.18    | 86   | MGU3.412.25 | 104  | MGU3.445.12 | 47   | MGU3.491.18 | 108  | MGU3.540.12CS | 42   |
| MGU3.213.25    | 86   | MGU3.412.30 | 47   | MGU3.445.18 | 104  | MGU3.491.25 | 108  | MGU3.540.18   | 96   |
| MGU3.213.30    | 32   | MGU3.413.12 | 47   | MGU3.445.25 | 104  | MGU3.491.30 | 51   | MGU3.540.25   | 96   |
| MGU3.214.12    | 36   | MGU3.413.18 | 104  | MGU3.445.30 | 47   | MGU3.492.12 | 51   | MGU3.540.30   | 42   |
| MGU3.214.18    | 90   | MGU3.413.25 | 104  | MGU3.446.12 | 47   | MGU3.492.18 | 108  | MGU3.540.30CS | 42   |
| MGU3.214.30    | 36   | MGU3.413.30 | 47   | MGU3.446.18 | 104  | MGU3.492.25 | 108  | MGU3.541.12   | 41   |
| MGU3.216.18CN  | 89   | MGU3.414.12 | 47   | MGU3.446.25 | 104  | MGU3.492.30 | 51   | MGU3.541.18   | 95   |
| MGU3.216.25CN  | 89   | MGU3.414.18 | 104  | MGU3.446.30 | 47   | MGU3.493.12 | 51   | MGU3.541.25   | 95   |
| MGU3.216.30CN  | 35   | MGU3.414.25 | 104  | MGU3.447.12 | 47   | MGU3.493.18 | 108  | MGU3.541.30   | 41   |
| MGU3.223.18    | 91   | MGU3.414.30 | 47   | MGU3.447.18 | 104  | MGU3.493.25 | 108  | MGU3.545.12   | 42   |
| MGU3.224.18    | 91   | MGU3.415.12 | 47   | MGU3.447.25 | 104  | MGU3.493.30 | 51   | MGU3.545.18   | 96   |
| MGU3.224.18S   | 91   | MGU3.415.18 | 104  | MGU3.447.30 | 47   | MGU3.493.12 | 51   | MGU3.545.25   | 96   |
| MGU3.224.25    | 91   | MGU3.415.25 | 104  | MGU3.450.12 | 49   | MGU3.495.18 | 108  | MGU3.545.30   | 42   |
| MGU3.224.25S   | 91   | MGU3.415.30 | 47   | MGU3.450.18 | 106  | MGU3.495.25 | 108  | MGU3.546.12   | 42   |
| MGU3.224.30    | 37   | MGU3.416.12 | 47   | MGU3.450.30 | 49   | MGU3.495.30 | 51   | MGU3.546.18   | 96   |
| MGU3.224.30S   | 37   | MGU3.416.18 | 104  | MGU3.451.12 | 49   | MGU3.497.12 | 51   | MGU3.546.25   | 96   |
| MGU3.226.12    | 36   | MGU3.416.25 | 104  | MGU3.451.18 | 106  | MGU3.497.18 | 108  | MGU3.546.30   | 42   |
| MGU3.226.18    | 90   | MGU3.416.30 | 47   | MGU3.451.25 | 106  | MGU3.497.25 | 108  | MGU3.549.12   | 39   |
| MGU3.226.25    | 90   | MGU3.417.12 | 47   | MGU3.451.30 | 49   | MGU3.497.30 | 51   | MGU3.559.18   | 93   |
| MGU3.226.30    | 36   | MGU3.417.18 | 104  | MGU3.452.12 | 49   | MGU3.498.12 | 51   | MGU3.559.25   | 93   |
| MGU3.231.12    | 37   | MGU3.417.25 | 104  | MGU3.452.18 | 106  | MGU3.498.18 | 108  | MGU3.559.30   | 39   |
| MGU3.231.18    | 91   | MGU3.417.30 | 47   | MGU3.452.25 | 106  | MGU3.498.25 | 108  | MGU3.572.12   | 56   |
| MGU3.231.25    | 91   | MGU3.418.12 | 53   | MGU3.452.30 | 49   | MGU3.498.30 | 51   | MGU3.572.18   | 113  |
| MGU3.231.30    | 37   | MGU3.418.18 | 110  | MGU3.453.12 | 49   | MGU3.499.12 | 51   | MGU3.572.25   | 113  |
| MGU3.232.12S   | 37   | MGU3.418.25 | 110  | MGU3.453.18 | 106  | MGU3.499.18 | 108  | MGU3.572.30   | 56   |
| MGU3.232.18S   | 91   | MGU3.418.30 | 53   | MGU3.453.25 | 106  | MGU3.499.25 | 108  | MGU3.573.12   | 56   |
| MGU3.232.25S   | 91   | MGU3.420.12 | 47   | MGU3.453.30 | 49   | MGU3.499.30 | 51   | MGU3.573.18   | 113  |
| MGU3.232.30S   | 37   | MGU3.420.18 | 104  | MGU3.454.12 | 49   | MGU3.501.12 | 41   | MGU3.573.25   | 113  |
| MGU3.236.12    | 34   | MGU3.420.25 | 104  | MGU3.454.18 | 106  | MGU3.501.18 | 95   | MGU3.573.30   | 56   |
| MGU3.236.18    | 88   | MGU3.420.30 | 47   | MGU3.454.25 | 106  | MGU3.501.25 | 95   | MGU3.574.12   | 56   |
| MGU3.236.25    | 88   | MGU3.421.18 | 104  | MGU3.454.30 | 49   | MGU3.501.30 | 41   | MGU3.574.18   | 113  |
| MGU3.236.30    | 34   | MGU3.421.25 | 104  | MGU3.455.12 | 49   | MGU3.503.12 | 41   | MGU3.574.25   | 113  |
| MGU3.246.1212V | 35   | MGU3.422.12 | 47   | MGU3.455.18 | 106  | MGU3.503.18 | 95   | MGU3.574.30   | 56   |
| MGU3.246.1812V | 89   | MGU3.422.18 | 104  | MGU3.455.25 | 106  | MGU3.503.25 | 95   | MGU3.579.12   | 35   |
| MGU3.246.2512V | 89   | MGU3.422.25 | 104  | MGU3.455.30 | 49   | MGU3.503.30 | 41   | MGU3.579.18   | 89   |
| MGU3.246.3012V | 35   | MGU3.422.30 | 47   | MGU3.456.12 | 49   | MGU3.505.12 | 41   | MGU3.579.25   | 89   |
| MGU3.261.12    | 32   | MGU3.423.12 | 47   | MGU3.456.18 | 106  | MGU3.505.18 | 95   | MGU3.579.30   | 35   |
| MGU3.261.12N   | 33   | MGU3.423.18 | 104  | MGU3.456.25 | 106  | MGU3.505.25 | 95   | MGU3.610.18   | 92   |
| MGU3.261.12S   | 33   | MGU3.423.25 | 104  | MGU3.456.30 | 49   | MGU3.505.30 | 41   | MGU3.610.25   | 92   |
| MGU3.261.18    | 86   | MGU3.423.30 | 47   | MGU3.462.12 | 50   | MGU3.510.12 | 39   | MGU3.611.18   | 92   |
| MGU3.261.18N   | 87   | MGU3.424.12 | 47   | MGU3.462.18 | 107  | MGU3.510.18 | 93   | MGU3.611.25   | 92   |
| MGU3.261.18S   | 87   | MGU3.424.18 | 104  | MGU3.462.25 | 107  | MGU3.510.25 | 93   | MGU3.612.18   | 92   |
| MGU3.261.25    | 86   | MGU3.424.25 | 104  | MGU3.462.30 | 50   | MGU3.510.30 | 39   | MGU3.612.25   | 92   |
| MGU3.261.25N   | 87   | MGU3.424.30 | 47   | MGU3.463.12 | 50   | MGU3.511.12 | 39   | MGU3.614.18   | 92   |
| MGU3.261.25S   | 87   | MGU3.425.12 | 47   | MGU3.463.18 | 107  | MGU3.511.18 | 93   | MGU3.614.25   | 92   |
| MGU3.261.30    | 32   | MGU3.425.18 | 104  | MGU3.463.25 | 107  | MGU3.511.25 | 93   | MGU3.615.18   | 92   |
| MGU3.261.30N   | 33   | MGU3.425.25 | 104  | MGU3.463.30 | 50   | MGU3.511.30 | 39   | MGU3.615.25   | 92   |
| MGU3.261.30S   | 33   | MGU3.425.30 | 47   | MGU3.464.12 | 50   | MGU3.515.12 | 39   | MGU3.630.18   | 92   |
| MGU3.262.12    | 32   | MGU3.426.12 | 47   | MGU3.464.18 | 107  | MGU3.515.18 | 93   | MGU3.630.25   | 92   |
| MGU3.262.12S   | 33   | MGU3.426.18 | 104  | MGU3.464.25 | 107  | MGU3.515.25 | 93   | MGU3.630.30   | 38   |
| MGU3.262.18    | 86   | MGU3.426.25 | 104  | MGU3.464.30 | 50   | MGU3.515.30 | 39   | MGU 3.631.12  | 38   |
| MGU3.262.18S   | 87   | MGU3.426.30 | 47   | MGU3.465.12 | 50   | MGU3.524.12 | 40   | MGU3.631.18   | 92   |
| MGU3.262.25    | 86   | MGU3.427.12 | 47   | MGU3.465.18 | 107  | MGU3.524.18 | 94   | MGU3.631.25   | 92   |
| MGU3.262.25S   | 87   | MGU3.427.18 | 104  | MGU3.465.25 | 107  | MGU3.524.25 | 94   | MGU3.631.30   | 38   |
| MGU3.262.30    | 32   | MGU3.427.25 | 104  | MGU3.465.30 | 50   | MGU3.524.30 | 40   | MGU3.632.18   | 92   |
| MGU3.262.30S   | 33   | MGU3.427.30 | 47   | MGU3.466.12 | 50   | MGU3.525.12 | 40   | MGU3.632.25   | 92   |
| MGU3.263.12    | 32   | MGU3.428.12 | 53   | MGU3.466.18 | 107  | MGU3.525.18 | 94   | MGU3.654.18   | 92   |
| MGU3.263.12N   | 33   | MGU3.428.18 | 110  | MGU3.466.25 | 107  | MGU3.525.25 | 94   | MGU3.654.25   | 92   |
| MGU3.263.12S   | 33   | MGU3.428.25 | 110  | MGU3.466.30 | 50   | MGU3.525.30 | 40   | MGU3.655.18   | 92   |
| MGU3.263.18    | 86   | MGU3.428.30 | 53   | MGU3.467.12 | 50   | MGU3.530.12 | 59   | MGU3.655.25   | 92   |
| MGU3.263.18N   | 87   | MGU3.429.12 | 52   | MGU3.467.18 | 107  | MGU3.530.18 | 116  | MGU3.656.18   | 92   |
| MGU3.263.18S   | 87   | MGU3.429.18 | 109  | MGU3.467.25 | 107  | MGU3.530.25 | 116  | MGU3.656.25   | 92   |
| MGU3.263.25    | 86   | MGU3.429.25 | 109  | MGU3.467.30 | 50   | MGU3.530.30 | 59   | MGU3.701.12   | 35   |
| MGU3.263.25N   | 87   | MGU3.429.30 | 52   | MGU3.468.12 | 49   | MGU3.531.12 | 59   | MGU3.701.18   | 89   |
| MGU3.263.25S   | 87   | MGU3.430.12 | 52   | MGU3.468.18 | 106  | MGU3.531.18 | 116  | MGU3.701.25   | 89   |
| MGU3.263.30    | 32   | MGU3.430.18 | 109  | MGU3.468.25 | 106  | MGU3.531.25 | 116  | MGU3.701.30   | 35   |
| MGU3.263.30N   | 33   | MGU3.430.25 | 109  | MGU3.468.30 | 49   | MGU3.531.30 | 59   | MGU3.710.12   | 42   |
| MGU3.263.30S   | 33   | MGU3.430.30 | 52   | MGU3.469.12 | 49   | MGU3.532.12 | 59   | MGU3.710.18   | 96   |
| MGU3.283.12    | 42   | MGU3.431.12 | 52   | MGU3.469.18 | 106  | MGU3.532.18 | 116  | MGU3.710.25   | 96   |
| MGU3.283.12CS  | 42   | MGU3.431.18 | 109  | MGU3.469.25 | 106  | MGU3.532.25 | 116  | MGU3.710.30   | 42   |
| MGU3.283.18    | 96   | MGU3.431.25 | 109  | MGU3.469.30 | 49   | MGU3.532.30 | 59   | MGU3.711.12   | 42   |
| MGU3.283.25    | 96   | MGU3.431.30 | 52   | MGU3.486.12 | 53   | MGU3.532.12 | 60   | MGU3.711.18   | 96   |
| MGU3.283.30    | 42   | MGU3.432.12 | 52   | MGU3.486.18 | 110  | MGU3.533.18 | 117  | MGU3.711.25   | 96   |
| MGU3.283.30CS  | 42   | MGU3.432.18 | 109  | MGU3.486.25 | 110  | MGU3.533.25 | 117  | MGU3.711.30   | 42   |
| MGU3.410.12    | 47   | MGU3.432.25 | 109  | MGU3.486.30 | 53   | MGU3.533.30 | 60   | MGU3.712      | 42   |
| MGU3.410.18    | 104  | MGU3.432.30 | 52   | MGU3.487.12 | 53   | MGU3.534.12 | 60   | MGU3.712      | 96   |
| MGU3.410.25    | 104  | MGU3.433.12 | 52   | MGU3.487.18 | 110  | MGU3.534.18 | 117  | MGU3.713.12   | 42   |
| MGU3.410.30    | 47   | MGU3.433.18 | 109  | MGU3.487.25 | 110  | MGU3.534.25 | 117  | MGU3.713.18   | 96   |
| MGU3.411.12    | 47   | MGU3.433.25 | 109  | MGU3.487.30 | 53   | MGU3.534.30 | 60   | MGU3.713.25   | 96   |
| MGU3.411.18    | 104  | MGU3.433.30 | 52   | MGU3.490.12 | 51   | MGU3.535.12 | 41   | MGU3.713.30   | 42   |

# Reference number overview

| Ref          | page | Ref         | page | Ref           | page | Ref           | page | Ref           | page |
|--------------|------|-------------|------|---------------|------|---------------|------|---------------|------|
| MGU3.716.12  | 42   | MGU4.102.13 | 142  | MGU5.064.18   | 99   | MGU6.004V.551 | 125  | MGU6.006V.577 | 126  |
| MGU3.716.18  | 96   | MGU4.102.18 | 142  | MGU5.064.30   | 45   | MGU6.004V.554 | 125  | MGU6.006V.824 | 126  |
| MGU3.716.25  | 96   | MGU4.102.24 | 142  | MGU5.512.12ZD | 39   | MGU6.004V.563 | 125  | MGU6.006V.851 | 126  |
| MGU3.716.30  | 42   | MGU4.102.25 | 142  | MGU5.512.18ZD | 93   | MGU6.004V.565 | 125  | MGU6.006V.854 | 126  |
| MGU3.775.12A | 51   | MGU4.102.30 | 142  | MGU5.512.25ZD | 93   | MGU6.004V.566 | 125  | MGU6.006V.865 | 126  |
| MGU3.775.12R | 51   | MGU4.102.42 | 142  | MGU5.512.30ZD | 39   | MGU6.004V.567 | 125  | MGU6.006V.867 | 126  |
| MGU3.775.12T | 51   | MGU4.102.51 | 142  | MGU6.002.12   | 76   | MGU6.004V.569 | 125  | MGU6.006V.869 | 126  |
| MGU3.775.12V | 51   | MGU4.102.54 | 142  | MGU6.002.18   | 124  | MGU6.004V.570 | 125  | MGU6.006V.870 | 126  |
| MGU3.775.18A | 108  | MGU4.102.58 | 142  | MGU6.002.25   | 124  | MGU6.004V.571 | 125  | MGU6.006V.871 | 126  |
| MGU3.775.18R | 108  | MGU4.102.59 | 142  | MGU6.002.30   | 76   | MGU6.004V.572 | 125  | MGU6.006V.872 | 126  |
| MGU3.775.18T | 108  | MGU4.102.60 | 142  | MGU6.002.524  | 124  | MGU6.004V.573 | 125  | MGU6.006V.873 | 126  |
| MGU3.775.18V | 108  | MGU4.102.62 | 142  | MGU6.002.542  | 124  | MGU6.004V.574 | 125  | MGU6.006V.874 | 126  |
| MGU3.775.25A | 108  | MGU4.102.64 | 142  | MGU6.002.551  | 124  | MGU6.004V.576 | 125  | MGU6.006V.876 | 126  |
| MGU3.775.25R | 108  | MGU4.102.67 | 142  | MGU6.002.554  | 124  | MGU6.004V.577 | 125  | MGU6.006V.877 | 126  |
| MGU3.775.25T | 108  | MGU4.103.13 | 142  | MGU6.002.563  | 124  | MGU6.004V.824 | 125  | MGU6.008.12   | 77   |
| MGU3.775.25V | 108  | MGU4.103.18 | 142  | MGU6.002.565  | 124  | MGU6.004V.842 | 125  | MGU6.008.18   | 126  |
| MGU3.775.30A | 51   | MGU4.103.24 | 142  | MGU6.002.566  | 124  | MGU6.004V.851 | 125  | MGU6.008.25   | 126  |
| MGU3.775.30R | 51   | MGU4.103.25 | 142  | MGU6.002.567  | 124  | MGU6.004V.854 | 125  | MGU6.008.30   | 77   |
| MGU3.775.30T | 51   | MGU4.103.30 | 142  | MGU6.002.569  | 124  | MGU6.004V.863 | 125  | MGU6.008.524  | 126  |
| MGU3.775.30V | 51   | MGU4.103.42 | 142  | MGU6.002.570  | 124  | MGU6.004V.865 | 125  | MGU6.008.542  | 126  |
| MGU3.776.T   | 54   | MGU4.103.51 | 142  | MGU6.002.571  | 124  | MGU6.004V.866 | 125  | MGU6.008.551  | 126  |
| MGU3.776.T   | 111  | MGU4.103.54 | 142  | MGU6.002.572  | 124  | MGU6.004V.867 | 125  | MGU6.008.554  | 126  |
| MGU3.780.T   | 54   | MGU4.103.58 | 142  | MGU6.002.573  | 124  | MGU6.004V.869 | 125  | MGU6.008.563  | 126  |
| MGU3.780.T   | 111  | MGU4.103.59 | 142  | MGU6.002.574  | 124  | MGU6.004V.870 | 125  | MGU6.008.565  | 126  |
| MGU3.785.12  | 54   | MGU4.103.60 | 142  | MGU6.002.576  | 124  | MGU6.004V.871 | 125  | MGU6.008.566  | 126  |
| MGU3.785.18  | 111  | MGU4.103.62 | 142  | MGU6.002.577  | 124  | MGU6.004V.872 | 125  | MGU6.008.567  | 126  |
| MGU3.785.25  | 111  | MGU4.103.64 | 142  | MGU6.002.824  | 124  | MGU6.004V.873 | 125  | MGU6.008.569  | 126  |
| MGU3.785.30  | 54   | MGU4.103.67 | 142  | MGU6.002.842  | 124  | MGU6.004V.874 | 125  | MGU6.008.570  | 126  |
| MGU3.786.12  | 54   | MGU4.104.13 | 143  | MGU6.002.851  | 124  | MGU6.004V.876 | 125  | MGU6.008.571  | 126  |
| MGU3.786.18  | 111  | MGU4.104.18 | 143  | MGU6.002.854  | 124  | MGU6.004V.877 | 125  | MGU6.008.572  | 126  |
| MGU3.786.25  | 111  | MGU4.104.24 | 143  | MGU6.002.863  | 124  | MGU6.006.12   | 77   | MGU6.008.573  | 126  |
| MGU3.786.30  | 54   | MGU4.104.25 | 143  | MGU6.002.865  | 124  | MGU6.006.18   | 125  | MGU6.008.574  | 126  |
| MGU3.860.12  | 55   | MGU4.104.30 | 143  | MGU6.002.866  | 124  | MGU6.006.25   | 125  | MGU6.008.576  | 126  |
| MGU3.860.18  | 112  | MGU4.104.42 | 143  | MGU6.002.867  | 124  | MGU6.006.30   | 77   | MGU6.008.577  | 126  |
| MGU3.860.25  | 112  | MGU4.104.51 | 143  | MGU6.002.869  | 124  | MGU6.006.524  | 125  | MGU6.008.824  | 126  |
| MGU3.860.30  | 55   | MGU4.104.54 | 143  | MGU6.002.870  | 124  | MGU6.006.542  | 125  | MGU6.008.842  | 126  |
| MGU3.862.12  | 55   | MGU4.104.58 | 143  | MGU6.002.871  | 124  | MGU6.006.551  | 125  | MGU6.008.851  | 126  |
| MGU3.862.18  | 112  | MGU4.104.59 | 143  | MGU6.002.872  | 124  | MGU6.006.554  | 125  | MGU6.008.854  | 126  |
| MGU3.862.25  | 112  | MGU4.104.60 | 143  | MGU6.002.873  | 124  | MGU6.006.563  | 125  | MGU6.008.863  | 126  |
| MGU3.862.30  | 55   | MGU4.104.62 | 143  | MGU6.002.874  | 124  | MGU6.006.565  | 125  | MGU6.008.865  | 126  |
| MGU4.000.01  | 149  | MGU4.104.64 | 143  | MGU6.002.876  | 124  | MGU6.006.566  | 125  | MGU6.008.866  | 126  |
| MGU4.000.05  | 149  | MGU4.104.67 | 143  | MGU6.002.877  | 124  | MGU6.006.567  | 125  | MGU6.008.867  | 126  |
| MGU4.000.06  | 149  | MGU4.106.13 | 143  | MGU6.004.12   | 76   | MGU6.006.569  | 125  | MGU6.008.869  | 126  |
| MGU4.000.13  | 149  | MGU4.106.18 | 143  | MGU6.004.18   | 124  | MGU6.006.570  | 125  | MGU6.008.870  | 126  |
| MGU4.000.18  | 149  | MGU4.106.24 | 143  | MGU6.004.25   | 124  | MGU6.006.571  | 125  | MGU6.008.871  | 126  |
| MGU4.000.24  | 149  | MGU4.106.25 | 143  | MGU6.004.30   | 76   | MGU6.006.572  | 125  | MGU6.008.872  | 126  |
| MGU4.000.25  | 149  | MGU4.106.30 | 143  | MGU6.004.524  | 124  | MGU6.006.573  | 125  | MGU6.008.873  | 126  |
| MGU4.000.31  | 149  | MGU4.106.42 | 143  | MGU6.004.542  | 124  | MGU6.006.574  | 125  | MGU6.008.874  | 126  |
| MGU4.000.34  | 149  | MGU4.106.51 | 143  | MGU6.004.551  | 124  | MGU6.006.576  | 125  | MGU6.008.876  | 126  |
| MGU4.000.42  | 149  | MGU4.106.54 | 143  | MGU6.004.554  | 124  | MGU6.006.577  | 125  | MGU6.008.877  | 126  |
| MGU4.000.43  | 149  | MGU4.106.58 | 143  | MGU6.004.563  | 124  | MGU6.006.824  | 125  | MGU6.014V.18  | 127  |
| MGU4.000.44  | 149  | MGU4.106.59 | 143  | MGU6.004.565  | 124  | MGU6.006.842  | 125  | MGU6.014V.25  | 127  |
| MGU4.000.48  | 149  | MGU4.106.60 | 143  | MGU6.004.566  | 124  | MGU6.006.851  | 125  | MGU6.014V.551 | 127  |
| MGU4.000.51  | 149  | MGU4.106.62 | 143  | MGU6.004.567  | 124  | MGU6.006.854  | 125  | MGU6.014V.567 | 127  |
| MGU4.000.54  | 149  | MGU4.106.64 | 143  | MGU6.004.569  | 124  | MGU6.006.863  | 125  | MGU6.014V.574 | 127  |
| MGU4.000.58  | 149  | MGU4.106.67 | 143  | MGU6.004.570  | 124  | MGU6.006.865  | 125  | MGU6.014V.824 | 127  |
| MGU4.000.59  | 149  | MGU4.702.26 | 136  | MGU6.004.571  | 124  | MGU6.006.866  | 125  | MGU6.014V.867 | 127  |
| MGU4.000.60  | 149  | MGU4.702.27 | 136  | MGU6.004.572  | 124  | MGU6.006.867  | 125  | MGU6.014V.871 | 127  |
| MGU4.000.62  | 149  | MGU4.702.28 | 136  | MGU6.004.573  | 124  | MGU6.006.869  | 125  | MGU6.014V.874 | 127  |
| MGU4.000.64  | 149  | MGU4.702.29 | 136  | MGU6.004.574  | 124  | MGU6.006.870  | 125  | MGU6.014V.877 | 127  |
| MGU4.002.18  | 148  | MGU4.702.35 | 136  | MGU6.004.576  | 124  | MGU6.006.871  | 125  | MGU6.016V.18  | 127  |
| MGU4.002.25  | 148  | MGU4.702.36 | 136  | MGU6.004.577  | 124  | MGU6.006.872  | 125  | MGU6.016V.25  | 127  |
| MGU4.004.18  | 148  | MGU4.702.37 | 136  | MGU6.004.824  | 124  | MGU6.006.873  | 125  | MGU6.016V.551 | 127  |
| MGU4.004.25  | 148  | MGU4.704.26 | 136  | MGU6.004.842  | 124  | MGU6.006.874  | 125  | MGU6.016V.567 | 127  |
| MGU4.006.18  | 148  | MGU4.704.27 | 136  | MGU6.004.851  | 124  | MGU6.006.876  | 125  | MGU6.016V.577 | 127  |
| MGU4.006.25  | 148  | MGU4.704.28 | 136  | MGU6.004.854  | 124  | MGU6.006.877  | 125  | MGU6.016V.824 | 127  |
| MGU4.008.18  | 148  | MGU4.704.29 | 136  | MGU6.004.863  | 124  | MGU6.006V.12  | 77   | MGU6.016V.865 | 127  |
| MGU4.008.25  | 148  | MGU4.704.35 | 136  | MGU6.004.865  | 124  | MGU6.006V.18  | 126  | MGU6.016V.867 | 127  |
| MGU4.010.18  | 148  | MGU4.704.36 | 136  | MGU6.004.866  | 124  | MGU6.006V.25  | 126  | MGU6.016V.871 | 127  |
| MGU4.010.25  | 148  | MGU4.704.37 | 136  | MGU6.004.867  | 124  | MGU6.006V.30  | 77   | MGU6.016V.874 | 127  |
| MGU4.101.13  | 142  | MGU4.706.26 | 136  | MGU6.004.869  | 124  | MGU6.006V.524 | 126  | MGU6.016V.877 | 127  |
| MGU4.101.18  | 142  | MGU4.706.27 | 136  | MGU6.004.870  | 124  | MGU6.006V.542 | 126  | MGU6.103.12   | 79   |
| MGU4.101.24  | 142  | MGU4.706.28 | 136  | MGU6.004.871  | 124  | MGU6.006V.551 | 126  | MGU6.103.30   | 79   |
| MGU4.101.25  | 142  | MGU4.706.29 | 136  | MGU6.004.872  | 124  | MGU6.006V.563 | 126  | MGU6.103.524  | 128  |
| MGU4.101.30  | 142  | MGU4.706.35 | 136  | MGU6.004.873  | 124  | MGU6.006V.565 | 126  | MGU6.103.542  | 128  |
| MGU4.101.42  | 142  | MGU4.706.36 | 136  | MGU6.004.874  | 124  | MGU6.006V.566 | 126  | MGU6.103.551  | 128  |
| MGU4.101.51  | 142  | MGU4.706.37 | 136  | MGU6.004.876  | 124  | MGU6.006V.567 | 126  | MGU6.103.554  | 128  |
| MGU4.101.54  | 142  | MGU4.708.26 | 136  | MGU6.004.877  | 124  | MGU6.006V.569 | 126  | MGU6.103.563  | 128  |
| MGU4.101.58  | 142  | MGU4.708.27 | 136  | MGU6.004V.12  | 76   | MGU6.006V.570 | 126  | MGU6.103.565  | 128  |
| MGU4.101.59  | 142  | MGU4.708.28 | 136  | MGU6.004V.18  | 125  | MGU6.006V.571 | 126  | MGU6.103.566  | 128  |
| MGU4.101.60  | 142  | MGU4.708.29 | 136  | MGU6.004V.25  | 125  | MGU6.006V.572 | 126  | MGU6.103.567  | 128  |
| MGU4.101.62  | 142  | MGU4.708.35 | 136  | MGU6.004V.30  | 76   | MGU6.006V.573 | 126  | MGU6.103.569  | 128  |
| MGU4.101.64  | 142  | MGU4.708.36 | 136  | MGU6.004V.524 | 125  | MGU6.006V.574 | 126  | MGU6.103.570  | 128  |
| MGU4.101.67  | 142  | MGU4.708.37 | 136  | MGU6.004V.542 | 125  | MGU6.006V.576 | 126  | MGU6.103.571  | 128  |



# Reference number overview

| Ref          | page | Ref             | page | Ref             | page | Ref           | page | Ref            | page |
|--------------|------|-----------------|------|-----------------|------|---------------|------|----------------|------|
| MGU6.103.572 | 128  | MGU6.506.25     | 130  | MGU9.200.12VMC  | 55   | MGU23.063.18D | 101  | MGU61.002.865  | 130  |
| MGU6.103.573 | 128  | MGU6.702.55     | 136  | MGU9.200.18BOIL | 112  | MGU23.063.25  | 101  | MGU61.002.866  | 130  |
| MGU6.103.574 | 128  | MGU6.702.56     | 136  | MGU9.200.18H    | 112  | MGU23.063.25D | 101  | MGU61.002.867  | 130  |
| MGU6.103.576 | 128  | MGU6.702.57     | 136  | MGU9.200.18L    | 112  | MGU23.065.18  | 101  | MGU61.002.869  | 130  |
| MGU6.103.577 | 128  | MGU6.704.55     | 136  | MGU9.200.18V    | 112  | MGU23.065.18D | 101  | MGU61.002.870  | 130  |
| MGU6.103.824 | 128  | MGU6.704.56     | 136  | MGU9.200.18VMC  | 112  | MGU23.065.25  | 101  | MGU61.002.871  | 130  |
| MGU6.103.842 | 128  | MGU6.704.57     | 136  | MGU9.200.25BOIL | 112  | MGU23.065.25D | 101  | MGU61.002.872  | 130  |
| MGU6.103.851 | 128  | MGU6.706.55     | 136  | MGU9.200.25H    | 112  | MGU23.067.18  | 101  | MGU61.002.873  | 130  |
| MGU6.103.854 | 128  | MGU6.706.56     | 136  | MGU9.200.25L    | 112  | MGU23.067.18D | 101  | MGU61.002.874  | 130  |
| MGU6.103.863 | 128  | MGU6.706.57     | 136  | MGU9.200.25V    | 112  | MGU23.067.25  | 101  | MGU61.002.876  | 130  |
| MGU6.103.866 | 128  | MGU6.708.55     | 136  | MGU9.200.25VMC  | 112  | MGU23.067.25D | 101  | MGU61.002.877  | 130  |
| MGU6.103.867 | 128  | MGU6.708.56     | 136  | MGU9.200.30BOIL | 55   | MGU47.201.12P | 81   | MGU61.037.18   | 97   |
| MGU6.103.869 | 128  | MGU6.708.57     | 136  | MGU9.200.30H    | 55   | MGU47.201.18P | 152  | MGU61.037.25   | 97   |
| MGU6.103.870 | 128  | MGU7.002        | 61   | MGU9.200.30L    | 55   | MGU47.201.25P | 152  | MGU63.063.18   | 102  |
| MGU6.103.871 | 128  | MGU7.002        | 118  | MGU9.200.30V    | 55   | MGU47.201.30P | 81   | MGU63.063.25   | 102  |
| MGU6.103.872 | 128  | MGU7.002.GG     | 61   | MGU9.200.30VMC  | 55   | MGU47.202.12P | 81   | MGU63.063.524  | 102  |
| MGU6.103.873 | 128  | MGU7.002.GG     | 118  | MGU9.410.12     | 47   | MGU47.202.18P | 152  | MGU63.063.563  | 102  |
| MGU6.103.874 | 128  | MGU7.002.GL     | 61   | MGU9.410.18     | 104  | MGU47.202.25P | 152  | MGU63.063.567  | 102  |
| MGU6.103.876 | 128  | MGU7.002.GL     | 118  | MGU9.410.25     | 104  | MGU47.202.30P | 81   | MGU63.063.824  | 102  |
| MGU6.103.877 | 128  | MGU7.002.GLS    | 61   | MGU9.410.30     | 47   | MGU48.424.18  | 129  | MGU63.063.842  | 102  |
| MGU6.104.12  | 79   | MGU7.002.GLS    | 118  | MGU9.411.12     | 47   | MGU48.424.25  | 129  | MGU63.063.851  | 102  |
| MGU6.104.30  | 79   | MGU7.002.P      | 61   | MGU9.411.18     | 104  | MGU48.424.524 | 129  | MGU63.063.854  | 102  |
| MGU6.104.524 | 128  | MGU7.002.P      | 118  | MGU9.411.25     | 104  | MGU48.424.567 | 129  | MGU63.063.863  | 102  |
| MGU6.104.542 | 128  | MGU7.002.PGL    | 61   | MGU9.411.30     | 47   | MGU48.424.571 | 129  | MGU63.063.865  | 102  |
| MGU6.104.551 | 128  | MGU7.002.PGL    | 118  | MGU9.420.12     | 47   | MGU48.424.574 | 129  | MGU63.063.866  | 102  |
| MGU6.104.563 | 128  | MGU7.004.P      | 61   | MGU9.420.18     | 104  | MGU48.424.576 | 129  | MGU63.063.867  | 102  |
| MGU6.104.565 | 128  | MGU7.004.P      | 118  | MGU9.420.25     | 104  | MGU48.424.824 | 129  | MGU63.063.869  | 102  |
| MGU6.104.566 | 128  | MGU7.012        | 61   | MGU9.420.30     | 47   | MGU48.424.842 | 129  | MGU63.063.870  | 102  |
| MGU6.104.567 | 128  | MGU7.012        | 118  | MGU9.421.12     | 47   | MGU48.424.851 | 129  | MGU63.063.871  | 102  |
| MGU6.104.569 | 128  | MGU7.012.GLS    | 61   | MGU9.421.18     | 104  | MGU48.424.854 | 129  | MGU63.063.872  | 102  |
| MGU6.104.571 | 128  | MGU7.012.GLS    | 118  | MGU9.421.25     | 104  | MGU48.424.863 | 129  | MGU63.063.874  | 102  |
| MGU6.104.572 | 128  | MGU7.103        | 61   | MGU9.421.30     | 47   | MGU48.424.865 | 129  | MGU63.063.876  | 102  |
| MGU6.104.573 | 128  | MGU7.103        | 118  | MGU9.438.18     | 105  | MGU48.424.866 | 129  | MGU63.065.18   | 102  |
| MGU6.104.574 | 128  | MGU7.103.P      | 61   | MGU9.438.25     | 105  | MGU48.424.867 | 129  | MGU63.065.18D  | 102  |
| MGU6.104.576 | 128  | MGU7.103.P      | 118  | MGU9.438.30     | 48   | MGU48.424.869 | 129  | MGU63.065.25   | 102  |
| MGU6.104.577 | 128  | MGU7.104        | 61   | MGU9.439.18     | 105  | MGU48.424.871 | 129  | MGU63.065.25D  | 102  |
| MGU6.104.824 | 128  | MGU7.104        | 118  | MGU9.440.12     | 50   | MGU48.424.872 | 129  | MGU63.065.524  | 102  |
| MGU6.104.842 | 128  | MGU7.104.P      | 61   | MGU9.440.18     | 107  | MGU48.424.873 | 129  | MGU63.065.524D | 102  |
| MGU6.104.851 | 128  | MGU7.104.P      | 118  | MGU9.440.25     | 107  | MGU48.424.874 | 129  | MGU63.065.542D | 102  |
| MGU6.104.854 | 128  | MGU7.106        | 118  | MGU9.440.30     | 50   | MGU48.424.877 | 129  | MGU63.065.551  | 102  |
| MGU6.104.863 | 128  | MGU7.892        | 61   | MGU9.441.12     | 50   | MGU48.426.18  | 129  | MGU63.065.551D | 102  |
| MGU6.104.865 | 128  | MGU7.892        | 118  | MGU9.441.18     | 107  | MGU48.426.25  | 129  | MGU63.065.554  | 102  |
| MGU6.104.866 | 128  | MGU7.892.A      | 61   | MGU9.441.25     | 107  | MGU48.426.524 | 129  | MGU63.065.554D | 102  |
| MGU6.104.867 | 128  | MGU7.892.A      | 118  | MGU9.441.30     | 50   | MGU48.426.567 | 129  | MGU63.065.563D | 102  |
| MGU6.104.869 | 128  | MGU8.002.18     | 119  | MGU9.460.12     | 47   | MGU48.426.574 | 129  | MGU63.065.565  | 102  |
| MGU6.104.871 | 128  | MGU8.002.25     | 119  | MGU9.460.18     | 104  | MGU48.426.824 | 129  | MGU63.065.565D | 102  |
| MGU6.104.872 | 128  | MGU8.004.18     | 119  | MGU9.460.25     | 104  | MGU48.426.851 | 129  | MGU63.065.566D | 102  |
| MGU6.104.873 | 128  | MGU8.004.25     | 119  | MGU9.460.30     | 47   | MGU48.426.865 | 129  | MGU63.065.567  | 102  |
| MGU6.104.874 | 128  | MGU8.006.18     | 119  | MGU9.461.12     | 47   | MGU48.426.867 | 129  | MGU63.065.567D | 102  |
| MGU6.104.876 | 128  | MGU8.006.25     | 119  | MGU9.461.18     | 104  | MGU48.426.871 | 129  | MGU63.065.569  | 102  |
| MGU6.104.877 | 128  | MGU8.103.18     | 119  | MGU9.461.25     | 104  | MGU48.426.872 | 129  | MGU63.065.569D | 102  |
| MGU6.106.12  | 79   | MGU8.103.25     | 119  | MGU9.461.30     | 47   | MGU48.426.874 | 129  | MGU63.065.571  | 102  |
| MGU6.106.30  | 79   | MGU8.104.18     | 119  | MGU9.864.12     | 55   | MGU48.426.877 | 129  | MGU63.065.571D | 102  |
| MGU6.106.524 | 128  | MGU8.104.25     | 119  | MGU9.864.18     | 112  | MGU49.424.010 | 80   | MGU63.065.572  | 102  |
| MGU6.106.542 | 128  | MGU8.601        | 61   | MGU9.864.25     | 112  | MGU49.424.038 | 80   | MGU63.065.572D | 102  |
| MGU6.106.551 | 128  | MGU8.601        | 119  | MGU9.864.30     | 55   | MGU49.424.039 | 80   | MGU63.065.574  | 102  |
| MGU6.106.554 | 128  | MGU8.603        | 61   | MGU9.865.12     | 55   | MGU49.424.210 | 80   | MGU63.065.574D | 102  |
| MGU6.106.563 | 128  | MGU8.603        | 119  | MGU9.865.18     | 112  | MGU49.424.238 | 80   | MGU63.065.576D | 102  |
| MGU6.106.565 | 128  | MGU8.604        | 61   | MGU9.865.25     | 112  | MGU49.424.239 | 80   | MGU63.065.577  | 102  |
| MGU6.106.566 | 128  | MGU8.604        | 119  | MGU9.865.30     | 55   | MGU49.424.504 | 129  | MGU63.065.577D | 102  |
| MGU6.106.567 | 128  | MGU8.624        | 61   | MGU9.866.12     | 55   | MGU49.424.510 | 129  | MGU63.065.824  | 102  |
| MGU6.106.569 | 128  | MGU8.624        | 119  | MGU9.866.18     | 112  | MGU49.424.804 | 129  | MGU63.065.824D | 102  |
| MGU6.106.571 | 128  | MGU8.626        | 61   | MGU9.866.25     | 112  | MGU49.424.810 | 129  | MGU63.065.842D | 102  |
| MGU6.106.572 | 128  | MGU8.626        | 119  | MGU9.866.30     | 55   | MGU49.426.010 | 80   | MGU63.065.851  | 102  |
| MGU6.106.574 | 128  | MGU9.100.12BOIL | 55   | MGU9.868.18     | 112  | MGU49.426.038 | 80   | MGU63.065.851D | 102  |
| MGU6.106.576 | 128  | MGU9.100.12H    | 55   | MGU9.868.25     | 112  | MGU49.426.039 | 80   | MGU63.065.854  | 102  |
| MGU6.106.824 | 128  | MGU9.100.12L    | 55   | MGU9.868.30     | 55   | MGU49.426.210 | 80   | MGU63.065.854D | 102  |
| MGU6.106.842 | 128  | MGU9.100.12VMC  | 55   | MGU11.103.18    | 130  | MGU49.426.238 | 80   | MGU63.065.863  | 102  |
| MGU6.106.851 | 128  | MGU9.100.18BOIL | 112  | MGU11.103.25    | 130  | MGU49.426.239 | 80   | MGU63.065.863D | 102  |
| MGU6.106.854 | 128  | MGU9.100.18H    | 112  | MGU11.104.18    | 130  | MGU49.426.504 | 129  | MGU63.065.865  | 102  |
| MGU6.106.863 | 128  | MGU9.100.18L    | 112  | MGU11.104.25    | 130  | MGU49.426.510 | 129  | MGU63.065.865D | 102  |
| MGU6.106.865 | 128  | MGU9.100.18VMC  | 112  | MGU22.302.18    | 119  | MGU49.426.804 | 129  | MGU63.065.866  | 102  |
| MGU6.106.866 | 128  | MGU9.100.25BOIL | 112  | MGU22.302.18    | 148  | MGU49.426.810 | 129  | MGU63.065.866D | 102  |
| MGU6.106.867 | 128  | MGU9.100.25H    | 112  | MGU22.302.18    | 153  | MGU61.002.18  | 130  | MGU63.065.867  | 102  |
| MGU6.106.869 | 128  | MGU9.100.25L    | 112  | MGU22.302.25    | 119  | MGU61.002.18G | 130  | MGU63.065.867D | 102  |
| MGU6.106.870 | 128  | MGU9.100.25VMC  | 112  | MGU22.302.25    | 148  | MGU61.002.25  | 130  | MGU63.065.869  | 102  |
| MGU6.106.871 | 128  | MGU9.100.30BOIL | 55   | MGU22.302.25    | 153  | MGU61.002.25G | 130  | MGU63.065.869D | 102  |
| MGU6.106.872 | 128  | MGU9.100.30H    | 55   | MGU22.304.18    | 119  | MGU61.002.804 | 130  | MGU63.065.870  | 102  |
| MGU6.106.874 | 128  | MGU9.100.30L    | 55   | MGU22.304.18    | 148  | MGU61.002.810 | 130  | MGU63.065.870D | 102  |
| MGU6.106.876 | 128  | MGU9.100.30VMC  | 55   | MGU22.304.18    | 153  | MGU61.002.824 | 130  | MGU63.065.871D | 102  |
| MGU6.106.877 | 128  | MGU9.200.12BOIL | 55   | MGU22.304.25    | 119  | MGU61.002.842 | 130  | MGU63.065.871D | 102  |
| MGU6.502.18  | 130  | MGU9.200.12H    | 55   | MGU22.304.25    | 148  | MGU61.002.851 | 130  | MGU63.065.872  | 102  |
| MGU6.502.25  | 130  | MGU9.200.12L    | 55   | MGU22.304.25    | 153  | MGU61.002.854 | 130  | MGU63.065.872D | 102  |
| MGU6.504.18  | 130  | MGU9.200.12V    | 55   | MGU23.063.18    | 101  | MGU61.002.863 | 130  | MGU63.065.873D | 102  |

# Reference number overview

| Ref            | page | Ref            | page | Ref            | page | Ref            | page | Ref           | page |
|----------------|------|----------------|------|----------------|------|----------------|------|---------------|------|
| MGU63.065.874  | 102  | MGU66.002.510  | 124  | MGU66.006.294  | 77   | MGU66.014V.292 | 78   | MGU66.106.095 | 79   |
| MGU63.065.874D | 102  | MGU66.002.804  | 124  | MGU66.006.295  | 77   | MGU66.014V.296 | 78   | MGU66.106.096 | 79   |
| MGU63.065.876  | 102  | MGU66.002.810  | 124  | MGU66.006.296  | 77   | MGU66.014V.297 | 78   | MGU66.106.097 | 79   |
| MGU63.065.876D | 102  | MGU66.004.0M2  | 76   | MGU66.006.297  | 77   | MGU66.016V.0M2 | 78   | MGU66.106.098 | 79   |
| MGU63.065.877  | 102  | MGU66.004.0M3  | 76   | MGU66.006.298  | 77   | MGU66.016V.2M3 | 78   | MGU66.106.210 | 79   |
| MGU63.065.877D | 102  | MGU66.004.0M4  | 76   | MGU66.006.504  | 125  | MGU66.016V.2M4 | 78   | MGU66.106.238 | 79   |
| MGU63.067.18   | 103  | MGU66.004.2M2  | 76   | MGU66.006.510  | 125  | MGU66.016V.010 | 78   | MGU66.106.239 | 79   |
| MGU63.067.18D  | 103  | MGU66.004.2M3  | 76   | MGU66.006.804  | 125  | MGU66.016V.038 | 78   | MGU66.106.292 | 79   |
| MGU63.067.25   | 103  | MGU66.004.2M4  | 76   | MGU66.006.810  | 125  | MGU66.016V.039 | 78   | MGU66.106.293 | 79   |
| MGU63.067.25D  | 103  | MGU66.004.010  | 76   | MGU66.006V.0M2 | 77   | MGU66.016V.092 | 78   | MGU66.106.294 | 79   |
| MGU63.067.524  | 103  | MGU66.004.038  | 76   | MGU66.006V.0M3 | 77   | MGU66.016V.096 | 78   | MGU66.106.295 | 79   |
| MGU63.067.524D | 103  | MGU66.004.039  | 76   | MGU66.006V.0M4 | 77   | MGU66.016V.097 | 78   | MGU66.106.296 | 79   |
| MGU63.067.551  | 103  | MGU66.004.092  | 76   | MGU66.006V.2M2 | 77   | MGU66.016V.210 | 78   | MGU66.106.297 | 79   |
| MGU63.067.554  | 103  | MGU66.004.093  | 76   | MGU66.006V.2M3 | 77   | MGU66.016V.238 | 78   | MGU66.106.298 | 79   |
| MGU63.067.567  | 103  | MGU66.004.094  | 76   | MGU66.006V.2M4 | 77   | MGU66.016V.239 | 78   | MGU68.002.7A1 | 70   |
| MGU63.067.571  | 103  | MGU66.004.095  | 76   | MGU66.006V.010 | 77   | MGU66.016V.292 | 78   | MGU68.002.7A2 | 70   |
| MGU63.067.572  | 103  | MGU66.004.096  | 76   | MGU66.006V.038 | 77   | MGU66.016V.296 | 78   | MGU68.002.7A3 | 70   |
| MGU63.067.576  | 103  | MGU66.004.097  | 76   | MGU66.006V.039 | 77   | MGU66.016V.297 | 78   | MGU68.002.7C1 | 70   |
| MGU63.067.576D | 103  | MGU66.004.098  | 76   | MGU66.006V.092 | 77   | MGU66.103.0M2  | 79   | MGU68.002.7C2 | 70   |
| MGU63.067.824D | 103  | MGU66.004.210  | 76   | MGU66.006V.093 | 77   | MGU66.103.0M3  | 79   | MGU68.002.7C3 | 70   |
| MGU63.067.842  | 103  | MGU66.004.238  | 76   | MGU66.006V.094 | 77   | MGU66.103.0M4  | 79   | MGU68.002.7P1 | 70   |
| MGU63.067.851  | 103  | MGU66.004.239  | 76   | MGU66.006V.095 | 77   | MGU66.103.2M2  | 79   | MGU68.002.7P2 | 70   |
| MGU63.067.854  | 103  | MGU66.004.292  | 76   | MGU66.006V.096 | 77   | MGU66.103.2M3  | 79   | MGU68.002.7Z1 | 70   |
| MGU63.067.863  | 103  | MGU66.004.293  | 76   | MGU66.006V.097 | 77   | MGU66.103.2M4  | 79   | MGU68.004.7A1 | 70   |
| MGU63.067.865D | 103  | MGU66.004.294  | 76   | MGU66.006V.098 | 77   | MGU66.103.010  | 79   | MGU68.004.7A2 | 70   |
| MGU63.067.866  | 103  | MGU66.004.295  | 76   | MGU66.006V.210 | 77   | MGU66.103.038  | 79   | MGU68.004.7A3 | 70   |
| MGU63.067.867  | 103  | MGU66.004.296  | 76   | MGU66.006V.238 | 77   | MGU66.103.039  | 79   | MGU68.004.7C1 | 70   |
| MGU63.067.867D | 103  | MGU66.004.297  | 76   | MGU66.006V.239 | 77   | MGU66.103.092  | 79   | MGU68.004.7C2 | 70   |
| MGU63.067.869  | 103  | MGU66.004.298  | 76   | MGU66.006V.292 | 77   | MGU66.103.093  | 79   | MGU68.004.7C3 | 70   |
| MGU63.067.870  | 103  | MGU66.004.504  | 124  | MGU66.006V.293 | 77   | MGU66.103.094  | 79   | MGU68.004.7P1 | 70   |
| MGU63.067.870D | 103  | MGU66.004.510  | 124  | MGU66.006V.294 | 77   | MGU66.103.095  | 79   | MGU68.004.7P2 | 70   |
| MGU63.067.871  | 103  | MGU66.004.804  | 124  | MGU66.006V.295 | 77   | MGU66.103.096  | 79   | MGU68.004.7Z1 | 70   |
| MGU63.067.872  | 103  | MGU66.004.810  | 124  | MGU66.006V.296 | 77   | MGU66.103.097  | 79   | MGU68.006.7A1 | 70   |
| MGU63.067.872D | 103  | MGU66.004V.0M2 | 76   | MGU66.006V.297 | 77   | MGU66.103.098  | 79   | MGU68.006.7A2 | 70   |
| MGU63.067.877  | 103  | MGU66.004V.0M3 | 76   | MGU66.006V.298 | 77   | MGU66.103.204  | 79   | MGU68.006.7A3 | 70   |
| MGU63.069.18   | 103  | MGU66.004V.0M4 | 76   | MGU66.006V.504 | 126  | MGU66.103.210  | 79   | MGU68.006.7C1 | 70   |
| MGU63.069.25   | 103  | MGU66.004V.2M2 | 76   | MGU66.006V.510 | 126  | MGU66.103.238  | 79   | MGU68.006.7C2 | 70   |
| MGU63.069.524  | 103  | MGU66.004V.2M3 | 76   | MGU66.006V.804 | 126  | MGU66.103.239  | 79   | MGU68.006.7C3 | 70   |
| MGU63.069.551  | 103  | MGU66.004V.2M4 | 76   | MGU66.006V.810 | 126  | MGU66.103.292  | 79   | MGU68.006.7P1 | 70   |
| MGU63.069.567  | 103  | MGU66.004V.010 | 76   | MGU66.008.0M2  | 77   | MGU66.103.293  | 79   | MGU68.006.7P2 | 70   |
| MGU63.069.574  | 103  | MGU66.004V.038 | 76   | MGU66.008.0M3  | 77   | MGU66.103.294  | 79   | MGU68.006.7Z1 | 70   |
| MGU63.069.824  | 103  | MGU66.004V.039 | 76   | MGU66.008.0M4  | 77   | MGU66.103.295  | 79   | MGU68.008.7A1 | 70   |
| MGU63.069.824D | 103  | MGU66.004V.092 | 76   | MGU66.008.2M2  | 77   | MGU66.103.296  | 79   | MGU68.008.7A2 | 70   |
| MGU63.069.851  | 103  | MGU66.004V.093 | 76   | MGU66.008.2M3  | 77   | MGU66.103.297  | 79   | MGU68.008.7A3 | 70   |
| MGU63.069.854  | 103  | MGU66.004V.094 | 76   | MGU66.008.2M4  | 77   | MGU66.103.298  | 79   | MGU68.008.7C1 | 70   |
| MGU63.069.863  | 103  | MGU66.004V.095 | 76   | MGU66.008.010  | 77   | MGU66.103.804  | 128  | MGU68.008.7C2 | 70   |
| MGU63.069.865  | 103  | MGU66.004V.096 | 76   | MGU66.008.038  | 77   | MGU66.103.810  | 128  | MGU68.008.7C3 | 70   |
| MGU63.069.866  | 103  | MGU66.004V.097 | 76   | MGU66.008.039  | 77   | MGU66.104.0M2  | 79   | MGU68.008.7P1 | 70   |
| MGU63.069.867  | 103  | MGU66.004V.098 | 76   | MGU66.008.092  | 77   | MGU66.104.0M3  | 79   | MGU68.008.7P2 | 70   |
| MGU63.069.869  | 103  | MGU66.004V.210 | 76   | MGU66.008.093  | 77   | MGU66.104.0M4  | 79   | MGU68.008.7Z1 | 70   |
| MGU63.069.870  | 103  | MGU66.004V.238 | 76   | MGU66.008.094  | 77   | MGU66.104.2M2  | 79   | MGU70.566.12  | 53   |
| MGU63.069.871  | 103  | MGU66.004V.239 | 76   | MGU66.008.095  | 77   | MGU66.104.2M3  | 79   | MGU70.566.18  | 110  |
| MGU63.069.872  | 103  | MGU66.004V.292 | 76   | MGU66.008.096  | 77   | MGU66.104.2M4  | 79   | MGU70.566.25  | 110  |
| MGU63.069.873  | 103  | MGU66.004V.293 | 76   | MGU66.008.097  | 77   | MGU66.104.010  | 79   | MGU70.566.30  | 53   |
| MGU63.069.874  | 103  | MGU66.004V.294 | 76   | MGU66.008.098  | 77   | MGU66.104.038  | 79   | MGU70.567.12  | 53   |
| MGU63.069.876  | 103  | MGU66.004V.295 | 76   | MGU66.008.210  | 77   | MGU66.104.039  | 79   | MGU70.567.18  | 110  |
| MGU63.069.877  | 103  | MGU66.004V.296 | 76   | MGU66.008.238  | 77   | MGU66.104.092  | 79   | MGU70.567.25  | 110  |
| MGU66.002.0M2  | 76   | MGU66.004V.297 | 76   | MGU66.008.239  | 77   | MGU66.104.093  | 79   | MGU70.567.30  | 53   |
| MGU66.002.0M3  | 76   | MGU66.004V.298 | 76   | MGU66.008.292  | 77   | MGU66.104.095  | 79   | MGU70.598     | 53   |
| MGU66.002.0M4  | 76   | MGU66.004V.504 | 125  | MGU66.008.293  | 77   | MGU66.104.096  | 79   | MGU70.598     | 110  |
| MGU66.002.2M2  | 76   | MGU66.004V.510 | 125  | MGU66.008.294  | 77   | MGU66.104.097  | 79   | MGU84.071.18  | 113  |
| MGU66.002.2M3  | 76   | MGU66.004V.804 | 125  | MGU66.008.295  | 77   | MGU66.104.098  | 79   | MGU84.071.25  | 113  |
| MGU66.002.2M4  | 76   | MGU66.004V.810 | 125  | MGU66.008.296  | 77   | MGU66.104.210  | 79   | MGU86.071.12  | 56   |
| MGU66.002.010  | 76   | MGU66.006.0M2  | 77   | MGU66.008.297  | 77   | MGU66.104.238  | 79   | MGU86.071.18  | 113  |
| MGU66.002.038  | 76   | MGU66.006.0M3  | 77   | MGU66.008.298  | 77   | MGU66.104.239  | 79   | MGU86.071.25  | 113  |
| MGU66.002.039  | 76   | MGU66.006.0M4  | 77   | MGU66.008.504  | 126  | MGU66.104.292  | 79   | MGU86.071.30  | 56   |
| MGU66.002.092  | 76   | MGU66.006.2M2  | 77   | MGU66.008.510  | 126  | MGU66.104.293  | 79   | MGU87.022.18  | 119  |
| MGU66.002.093  | 76   | MGU66.006.2M3  | 77   | MGU66.008.804  | 126  | MGU66.104.294  | 79   | MGU87.022.25  | 119  |
| MGU66.002.094  | 76   | MGU66.006.2M4  | 77   | MGU66.008.810  | 126  | MGU66.104.295  | 79   | MGU87.022.58  | 61   |
| MGU66.002.095  | 76   | MGU66.006.010  | 77   | MGU66.014V.0M2 | 78   | MGU66.104.296  | 79   | MGU87.022.62  | 61   |
| MGU66.002.096  | 76   | MGU66.006.038  | 77   | MGU66.014V.0M3 | 78   | MGU66.104.297  | 79   | MGU87.024.18  | 119  |
| MGU66.002.097  | 76   | MGU66.006.039  | 77   | MGU66.014V.0M4 | 78   | MGU66.104.298  | 79   | MGU87.024.25  | 119  |
| MGU66.002.098  | 76   | MGU66.006.092  | 77   | MGU66.014V.2M2 | 78   | MGU66.106.0M2  | 79   | MGU87.024.58  | 61   |
| MGU66.002.099  | 76   | MGU66.006.093  | 77   | MGU66.014V.2M3 | 78   | MGU66.106.0M3  | 79   | MGU87.024.62  | 61   |
| MGU66.002.104  | 76   | MGU66.006.094  | 77   | MGU66.014V.2M4 | 78   | MGU66.106.0M4  | 79   | MGU87.026.18  | 119  |
| MGU66.002.238  | 76   | MGU66.006.095  | 77   | MGU66.014V.010 | 78   | MGU66.106.2M2  | 79   | MGU87.026.25  | 119  |
| MGU66.002.292  | 76   | MGU66.006.096  | 77   | MGU66.014V.038 | 78   | MGU66.106.2M3  | 79   | MGU87.026.58  | 61   |
| MGU66.002.293  | 76   | MGU66.006.097  | 77   | MGU66.014V.039 | 78   | MGU66.106.2M4  | 79   | MGU87.026.62  | 61   |
| MGU66.002.294  | 76   | MGU66.006.098  | 77   | MGU66.014V.092 | 78   | MGU66.106.010  | 79   | MGU87.026.62  | 61   |
| MGU66.002.295  | 76   | MGU66.006.210  | 77   | MGU66.014V.096 | 78   | MGU66.106.038  | 79   | MGU88.071.12  | 56   |
| MGU66.002.296  | 76   | MGU66.006.238  | 77   | MGU66.014V.097 | 78   | MGU66.106.039  | 79   | MGU88.071.30  | 56   |
| MGU66.002.297  | 76   | MGU66.006.239  | 77   | MGU66.014V.210 | 78   | MGU66.106.092  | 79   | MTN570222     | 59   |
| MGU66.002.298  | 76   | MGU66.006.292  | 77   | MGU66.014V.238 | 78   | MGU66.106.093  | 79   | MTN570222     | 116  |
| MGU66.002.504  | 124  | MGU66.006.293  | 77   | MGU66.014V.239 | 78   | MGU66.106.094  | 79   |               |      |



Life Is On



**Schneider Electric Industries SAS**

35, rue Joseph Monier  
CS 30323  
92506 Rueil Malmaison Cedex  
France

RCS Nanterre 954 503 439  
Capital social 896 313 776 €  
[www.schneider-electric.com](http://www.schneider-electric.com)

Janvier, 2017  
Unica catalogue

© 2017 - Schneider Electric. All Rights Reserved.  
All trademarks are owned by Schneider Electric Industries SAS or its affiliated companies.  
ISC01064EN

This document has been  
printed on recycled paper

