

# Product Data Sheet

## GW94358

90 RCD Range



Description	RCCB WITH OVERCURRENT PROTECTION
Code	MDC 60
No. of poles	3P
No. modules	3
Rated current	20 A
Rated residual operating current	300 mA
Type	A
Curve	C
Rated voltage (IEC/EN 61009-1, 61009-2-1)	400/415 V

Energy limiting class	1	Standard	IEC/EN 61009-1, IEC/EN 61009-2-1
Rated frequency (Hz)	50/60 Hz	Breaking capacity IEC/EN 61009-1 400V (Icn)	6000 A
Breaking capacity IEC/EN 61009-1 (Ics)	1 x Icn	Breaking capacity IEC/EN 60947-2 400V (Icu)	6 kA
Breaking capacity IEC/EN 60947-2 (Ics)	100% Icu	Insulation voltage	500 V
Level of immunity (8/20 μs)	250 A	Rated impulse withstand voltage	4 kV
Overvoltage category	III	Electrical endurance	10.000
Mechanical endurance	20.000	Section rigid cable	<=1x35 - <=2x16 - <=1x16+2x10 mm <sup>2</sup>
Section flexible cable	<=1x35 - <=2x16 - <=1x16+2x10 mm <sup>2</sup>	Double connection	YES (only down stream)
Rated tightening torque	2 Nm	Operating temperature	-25 +60° C (derating of In with T>30° C)
Stocking temperature	-40 +70 °C	Auxiliaries compatibility	Yes
Assembly position	Any		

### DIMENSIONAL

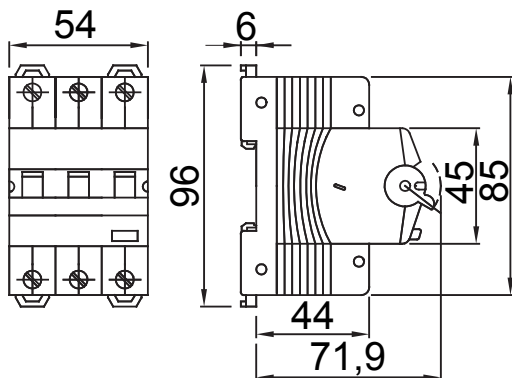

### WIRING DIAGRAM



### STANDARDS/APPROVALS

