

ERG740 ERGONOMIC HAND TOOL OPERATING INSTRUCTIONS for RSK Series Wrap Around Connectors

IMPORTANT: Read and understand all of the instructions and safety information in this manual before operating or servicing this tool.

INTENDED USE: Wrap around connectors have been designed to ground the shield of single or multiple conductor shielded cables. It is suggested that the customer evaluate the suitability of these connectors and verify their performance for the particular application.



WARNING

**KEEP ALL BODY PARTS AWAY FROM DIE NEST
DURING GAGING OR CRIMPING PROCEDURE.**



WARNING

**HANDLES ARE NON-INSULATING.
DO NOT CRIMP ON HOT ENERGIZED WIRES.**

OPERATING INSTRUCTIONS

1

MATCHING THE CONNECTOR AND DIE TO THE CABLE

1. Measure the diameter of the cable shield using a calibrated measuring tool or the RSK gauge (part number RSK-LEHRE) which is in the tool case lid. Rotate the cable in order to locate the maximum shield diameter. Exert only light pressure on the cable to get an accurate measurement, see Figure. 1.

When using the RSK gauge, try to find the appropriate slot in the gauge by ensuring that the cable only goes in the top of the slot. If the cable goes completely to the bottom of the slot, you should try the cable in the smaller adjacent slot.

Once you find the appropriate slot, you can read the associated RSK connector by the color of the slot and the appropriate die by the number marked below the slot.

2. For twisted pair and other non-symmetrical shielded cables, measure the dimension of the major axis or the largest width of the cable.

When you use the RSK gauge, try to find the appropriate slot in the gauge by fitting the largest width of the cable into the slot. Similar to step 1, if the cable goes completely to the bottom of the slot, try the next smaller adjacent slot.

3. Once the shield diameter is established, refer to Table 1 for the appropriate connector and installing die.

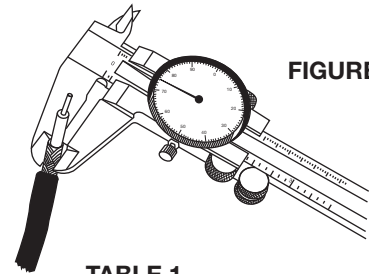

FIGURE 1

TABLE 1

DIAMETER OF SHIELD	CONNECTOR CAT. NO. & CODE	DIE CAT. NO (STEEL)	GROUND WIRE RANGE
(1.27 - 1.79 mm) .050 - .070 in.	RSK101 or RSK5101 RED	D-101A	1 OR 2 PIECES 0.25mm ² #24 AWG STR OR 1 #22 AWG STR
(1.80 - 2.28 mm) .071 - .089 in.		D-101B	
(2.29 - 2.55 mm) .090 - .100 in.	RSK201 or RSK5201 BLUE	D-201C	1 OR 2 PIECES 0.25mm ² #22 AWG STR or 1 PIECE 0.5mm ² #20 AWG STR
(2.56 - 3.00 mm) .101 - .118 in.		D-201D	
(3.01 - 3.34 mm) .119 - .131 in.		D-201E	
(3.35 - 3.65 mm) .132 - .143 in.		D-201F	
(3.66 - 4.13 mm) .144 - .162 in.	RSK301 or RSK5301 YELLOW	D-301G	1 OR 2 PIECES 0.25mm ² #22 AWG STR 1 PIECE 0.5mm ² OR 2 #20 AWG STR
(4.14 - 4.71 mm) .163 - .185 in.		D-301H	
(4.72 - 5.12 mm) .186 - .201 in.		D-301J	
(5.13 - 5.86 mm) .202 - .230 in.	RSK401 or RSK5401 GREEN	D-401K	1 OR 2 PIECES 0.5mm ² #20 AWG STR or 1 PIECE 0.75mm ² #18 AWG STR
(5.87 - 6.36 mm) .231 - .250 in.		D-401L	
(6.37 - 7.00 mm) .251 - .275 in.		D-401M	
(7.01 - 7.62 mm) .276 - .300 in.		D-401N	

2

INSTALLING THE DIES IN THE ERG740 TOOL

1. Open the tool handles completely to fully retract the ram.
2. Insert the stem of upper die into the tool frame.
3. Insert the separation spring of the lower die into the upper die opening. Push up firmly, and insert the lower die stem into the hole in the ram.

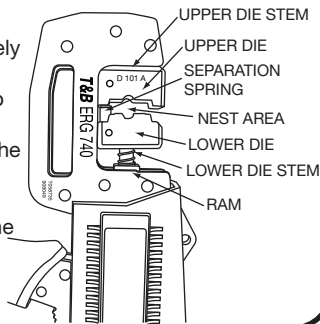

3

CABLE PREPARATION

CAUTION
During all stripping operations, use extreme care to prevent nicking or cutting of the shield or inner conductor insulation. This could result in short circuits.

NOTE: These connectors should not be used with multi-conductor shielded cables whose conductors are solid or stranded bonded wire.

1. Remove the cable jacket as required and prepare the shield as shown in the standard method illustration.
2. When the cable inner conductor insulation is vinyl of .015 in. or less thickness or Teflon* of .010 in. or less thickness, use foldback method 1 or 2 as illustrated.
3. When the shield is foil or is spiral wrapped, use foldback method 2.
4. When using either foldback method, be sure to measure the diameter of the shield after it is folded back. Refer to Table 1 for proper die selection.

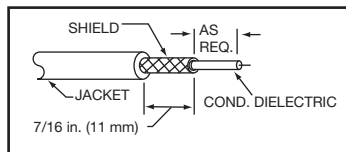

STANDARD METHOD

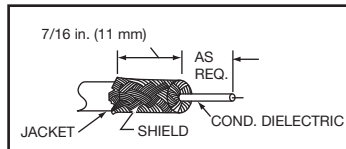

FOLDBACK METHOD 1

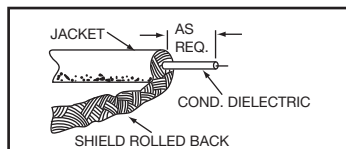

FOLDBACK METHOD 2

*Teflon is a registered trademark of E.I. Du Pont de Nemours and Company

For Parts or Service, contact the Thomas & Betts Tool Service Center at 1-800-284-TOOL (8665).

WARRANTY: Thomas & Betts sells this product with the understanding that the user will perform all necessary tests to determine the suitability of this product for the user's intended application. Thomas & Betts warrants that this product will be free from defects in materials and workmanship for the period stated on the enclosed warranty card. Upon prompt notification of any warranted defect, Thomas & Betts will, at its option, repair or replace the defective product or refund the purchase price. Proof of purchase is required. Misuse or unauthorized modification of the product voids all warranties.

Limitations and Exclusions: THE ABOVE WARRANTY IS THE SOLE WARRANTY CONCERNING THIS PRODUCT, AND IS IN LIEU OF ALL OTHER WARRANTIES EXPRESS OR IMPLIED, INCLUDING BUT NOT LIMITED TO ANY IMPLIED WARRANTY OF MERCHANTABILITY OR FITNESS FOR A PARTICULAR PURPOSE, WHICH ARE SPECIFICALLY DISCLAIMED. LIABILITY FOR BREACH OF THE ABOVE WARRANTY IS LIMITED TO COST OF REPAIR OR REPLACEMENT OF THE PRODUCT, AND UNDER NO CIRCUMSTANCES WILL THOMAS & BETTS BE LIABLE FOR ANY INDIRECT, SPECIAL, INCIDENTAL OR CONSEQUENTIAL DAMAGES.

4

GROUND WIRE PREPARATION

1. For a single ground wire, strip the wire 7/16 in (11mm) and twist the strands together.
2. For two ground wires, strip each wire 1/2 in. (12mm) and twist the two wires together.
3. If hairpinning (hooking) the ground wire is desired, strip the wire 1/2 in. (12mm) and bend it as shown. Use one die size larger.

CAUTION
Do not solder dip the ground wire ends.
Do not use solid ground wire.

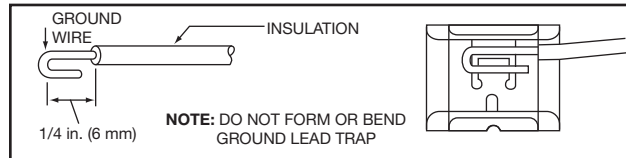

HAIRPIN GROUND WIRE

5

INSTALLING THE CONNECTOR ON SHIELDED CABLE

1. Insert the connector, with the ground trap facing up, into the nest area of the die. Be sure to center the connector.
2. Place the ground wire into the ground trap and the shielded cable into the bottom to the connector. Be sure to butt the cable jacket and the ground wire insulation against the metal connector edge. The ground wire can exit from either direction.
3. Squeeze the tool handles completely to form the connector around the shield.

CAUTION
Be sure that neither the cable outer jacket nor the ground wire insulation is under the metal portion of the connector. This will overload the dies.

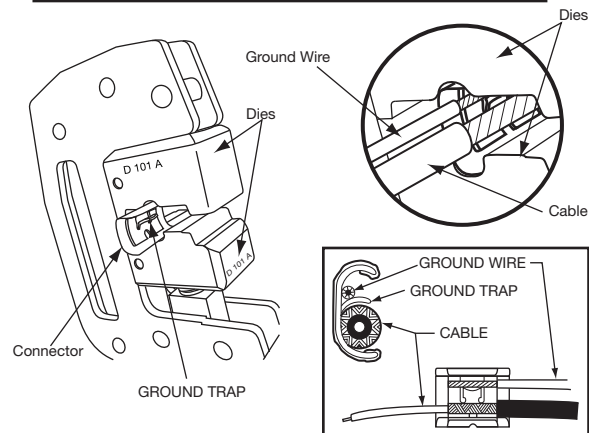

6

GAUGING THE DIES

1. Install the die set into the ERG740 Tool.
2. Close the tool handles until the die faces are touching.
3. Using calipers, measure the die nest height and compare to the die gauging chart to ensure die nest opening is within the specified tolerance range.

CAT. No.	DIM. (mm)	TOL.
D-101A	3.6 mm	±0.10 mm
D-101B	3.9 mm	±0.10 mm
D-201C	4.4 mm	±0.10 mm
D-201D	4.6 mm	±0.10 mm
D-201E	4.9 mm	±0.10 mm
D-201F	5.1 mm	±0.10 mm
D-301G	6.2 mm	±0.10 mm
D-301H	6.5 mm	±0.10 mm
D-301J	6.8 mm	±0.10 mm
D-401K	8.0 mm	±0.10 mm
D-401L	8.2 mm	±0.10 mm
D-401M	8.8 mm	±0.10 mm
D-401N	9.1 mm	±0.10 mm