

SpaceLogic Sensors

SXWS Sensor Touchscreen Covers



Note: A subset of models shown.

Product Description

SXWS sensors are a family of living space sensors for use with MP and RP Series IP controllers that use the EcoStruxure Building Operation software user interface. These sensors use an RJ-45 sensor bus that provides communication and power from the controller. SXWS living space sensors are modular and are ordered in two parts: the sensor base and the cover. Four communicating sensor base models are available that can be paired with any one of 14 touchscreen covers.

All SXWCDxxxxxx touchscreen covers display current time, temperature, humidity percentage (if equipped), CO₂ ppm (if equipped), as well as heating, cooling and Eco mode status. The touchscreen is configurable through EcoStruxure Building Operation software to add buttons for temperature setpoint, override, temperature scale, fan speed, lighting control, blind control, lighting and blind scenes, heating mode, cooling mode, and Auto HVAC mode.

SXWCDxxxxxx touchscreen covers are available in Medium matte white housings or Optimum glass panel housings available in white or black. Optimum glass panel housings are available with capacitive buttons for one-touch light and blind control located below the touchscreen.

All SXWCDxxxxxx touchscreen covers are available with a passive infrared (PIR) occupancy sensor. The system may be configured in EcoStruxure Building Operation software to override comfort settings to occupied status when occupancy is detected during scheduled unoccupied periods.

Features

- Medium matte white housing or optimum glass panel housing available in white or black
- Full color, 61mm (2.4 in.), 240 x 320 pixel, capacitive touchscreen display
- Displays sensor readings, time, network status
- Light and blind control with setpoint adjust
- Configurable preset scenes for light and blind control
- Temperature setpoint
- Override
- Display timeout
- Display lockout
- HVAC mode adjustment
- Passive Infrared (PIR) motion/occupancy sensor (optional)

Applicable Documentation

Title	Description
SXWS Living Space Sensor Base	Installation instructions for all base variants
SXWS Living Space Sensor Blank Cover	Installation instructions for blank cover without occupancy sensor
SXWS Living Space Sensor Button and Occupancy Covers	Installation instructions for 3-button covers with and without occupancy sensors and blank cover with occupancy sensor
SXWS Living Space LCD Temperature Sensor	LCD temperature sensor base and cover installation instructions
SXWS Living Space Resistive Temperature Sensor	Non-communicating temperature sensor installation instructions

USA: +1 888-444-1311
 Europe: +46 10 478 2000
 Asia: +65 6484 7877
www.schneider-electric.com

Life Is On



Available Products

SXWS Sensor Bases

Model Number	Description	Temp	RH	CO ₂	Cover	IP Controller System Bus (Communicating)
SXWSBTXXXSXX	Sensor Base, Temperature	X			Not Included	X
SXWSBTHXXSXX	Sensor Base, Temperature, Humidity	X	X		Not Included	X
SXWSBTXCXSXX	Sensor Base, Temperature, CO ₂	X		X	Not Included	X
SXWSBTHCXSSXX	Sensor Base, Temp, Humidity, CO ₂	X	X	X	Not Included	X

Covers for Use with Sensor Bases

Model Number	61mm (2.4") Color Touchscreen with Light & Blind Control	Override	Setpoint	Off-Touchscreen Light & Blind Control Buttons	Off-Touchscreen Light Control Buttons	Occupancy Sensor (PIR)	Housing Finish
SXWSCDXSELXX	X	X	X				Medium, White
SXWSCDPSELXX	X	X	X			X	Medium, White
SXWSCDXSELXW	X	X	X				Optimum, White
SXWSCDPSELXW	X	X	X			X	Optimum, White
SXWSCDXSELXB	X	X	X				Optimum, Black
SXWSCDPSELXB	X	X	X			X	Optimum, Black
SXWSC2XSELXW	X	X	X		X		Optimum, White
SXWSC4XSELXW	X	X	X	X			Optimum, White
SXWSC2PSELXW	X	X	X		X	X	Optimum, White
SXWSC4PSELXW	X	X	X	X		X	Optimum, White
SXWSC2XSELXB	X	X	X		X		Optimum, Black
SXWSC4XSELXB	X	X	X	X			Optimum, Black
SXWSC2PSELXB	X	X	X		X	X	Optimum, Black
SXWSC4PSELXB	X	X	X	X		X	Optimum, Black

USA: +1 888-444-1311
 Europe: +46 10 478 2000
 Asia: +65 6484 7877
www.schneider-electric.com

Life Is On

Schneider
Electric

Specifications

Touchscreen	
Display	61 mm (2.4"), color, capacitive overlay
Pixel count	240 x 320
Backlight	Yes
Setpoint	Temperature, Humidity or Fan Speed (setpoint type and allowable span set in EcoStruxure Building Operation software)
Override	Overrides unoccupied mode (duration and comfort parameters configured in EcoStruxure Building Operation software)
Timeout	Configurable through EcoStruxure Building Operation software
Lockout	Configurable through EcoStruxure Building Operation software
Light and Blind Control	
Number of light control zones	1 manually controlled 4 configurable in scenes
Number of blind control zones	1 manually controlled 4 configurable in scenes
User interface	Any SXWS cover with touchscreen
Communication	Sensor Bus on RP-x models with light/blind modules
Preconfigured scenes	Configurable via EcoStruxure Building Operation software
Light control	On/off/dimming
Blind control	Blind open /close/adjust Louver open/close/adjust

Occupancy Version	
Occupancy sensor	Passive infrared
Lateral detection angle	140°
Horizontal detection angle	±15°
Detection range	4-6 m (13-20 ft.) angle dependent (see detection pattern diagram, page 3)
Operating Environment	
Operating temperature	0 to 50 °C (32 to 122 °F)
Operating humidity range	0 to 95% RH, non-condensing
Housing material	High impact ABS plastic Flammability rating UL 94 V-0
Mounting location	Not suitable for wet locations. For indoor use only.
Input power	Supplied by SXWS sensor base
Regulatory Information	
Agency approvals	UL 916 European conformance CE: EN61000-6-3 EN61000 Series - industrial immunity std. FCC Part 15 Class B, REACH, RoHS, Green Premium, RCM (Australia), ICES-003 (Canada), EAC (Russia)

Dimensions mm (in.) SXWS Base Cover

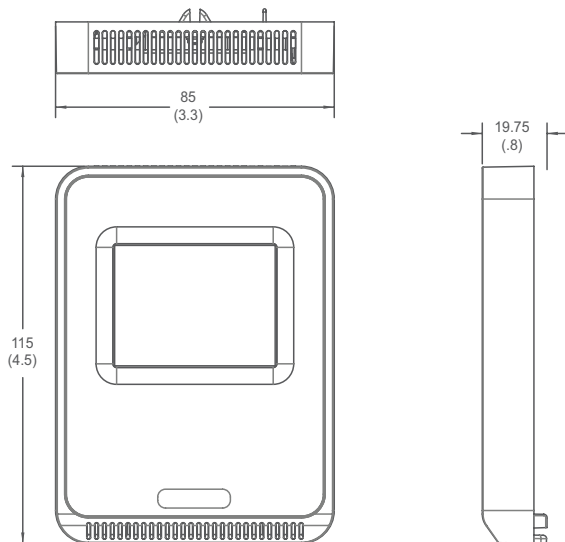

Optimum Housing

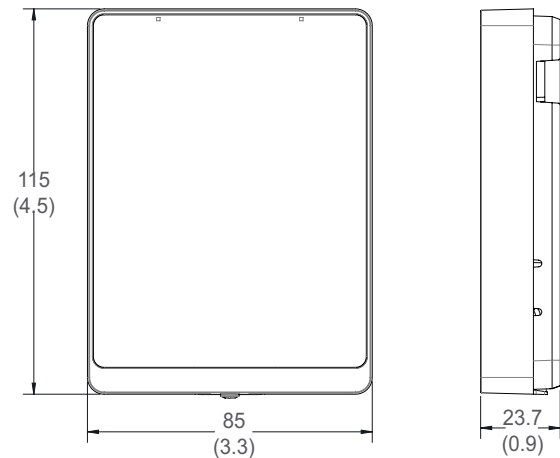

USA: +1 888-444-1311
Europe: +46 10 478 2000
Asia: +65 6484 7877
www.schneider-electric.com

Life Is On

Schneider Electric

Precautions

- This product is not intended for life or safety applications.
- Do not install this product in hazardous or classified locations.
- Read and understand the instructions before installing the product.
- Turn off all power supplying equipment before working on it.
- The installer is responsible for conformance to all applicable codes.

If this product is used in a manner not specified by the manufacturer, the protection provided by the product may be impaired. No responsibility is assumed by the manufacturer for any consequences arising out of the use of this material.

Installation

1. With sensor base fully installed, align top of cover to mounting tabs on top of sensor base. Swing cover downward until it latches at the bottom.
2. Install locking screw to secure cover in closed position.



Typical PIR Lens Detection Pattern

A typical detection pattern for the PIR cover is illustrated below.

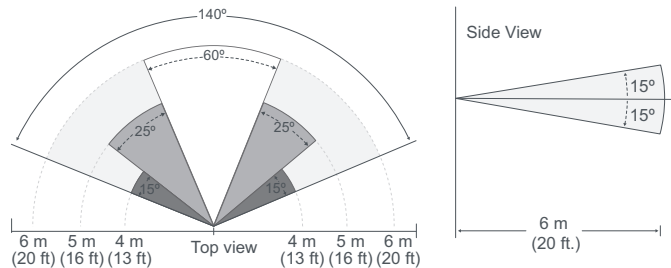

Fresnel Lens Beam and Detection Field

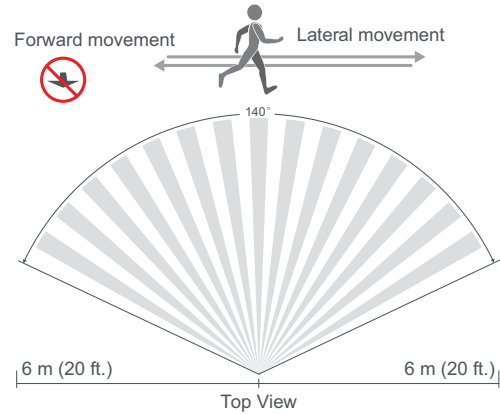

PIR Installation Considerations

Install the SXWS room unit with occupancy sensor as close to a door as possible (but not blocked by the door) or in an area with high occupant movement.

The unit should be installed 1.35 m (4.5 ft.) above the floor surface to ensure the maximum detection range is achieved. Ensure that occupants will cross the lens beam in a perpendicular path within the prescribed detection zone.

Recommended Installation Example

Room 1 shows one SXWS room unit with occupancy sensor installed beside a door in the middle of the room. Occupant traffic is high in several areas of the room. Occupant movement typically flows lateral to the PIR, maximizing detection and within the PIR detection range of 6 m (20 ft.) at 140°, and 5 m (16 ft.) between 15° to 30° laterally.

Room 2 shows one SXWS room unit with occupancy sensor installed adjacent to the door. Occupant traffic is high and ensures the occupant will almost always cross the PIR detection path laterally and within the detection range.

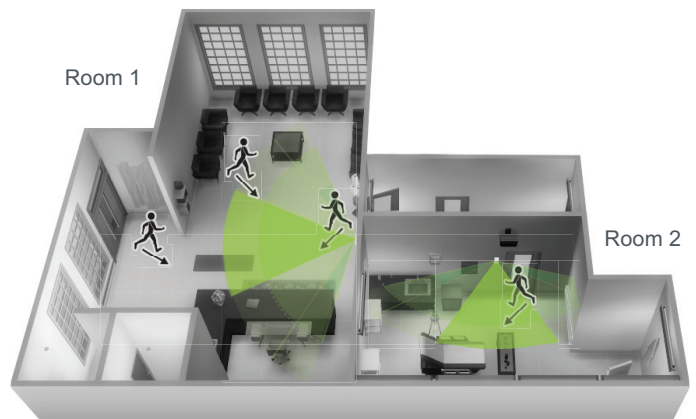

USA: +1 888-444-1311
 Europe: +46 10 478 2000
 Asia: +65 6484 7877
www.schneider-electric.com

Life Is On



Non-recommended Installation Example

Room 1 shows one SXWS room unit with occupancy sensor installed near the entrance, and a second installed beside the reception area. The unit installed at the entrance behind the door may be blocked. For the unit installed beside the reception area, occupant traffic could fall outside the detection zone.

Room 2 shows one SXWS room unit with occupancy sensor installed in a low traffic area near the door, and a second installed on the wall directly opposite the door. The unit installed near the door could be blocked by the opened door, restricting PIR detection. The unit installed opposite the door could fall outside the specified detection zone and most occupant movement may not fall within lateral crossing patterns for PIR detection.

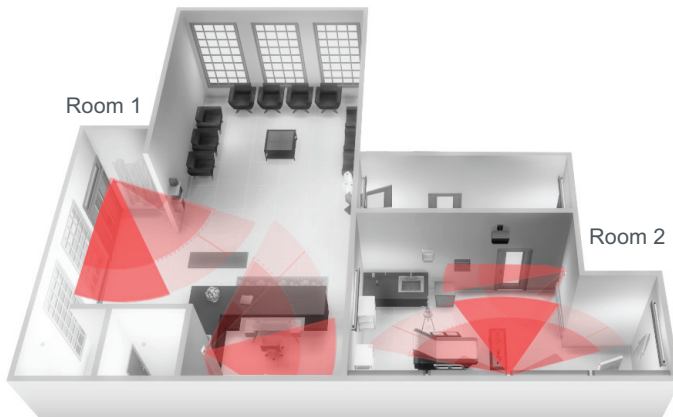

Features

Touchscreen covers connect to a sensor base and provide an attractive user interface. The cover/base unit communicates sensor readings back to the Schneider Electric IP controller via the Sensor Bus. The display provides local sensor status and allows the user to adjust comfort settings within the parameters set in EcoStruxure Building Operation software. The display and touchscreen can be configured through EcoStruxure Building Operation software to be active at specific times. For example, to minimize unintended usage, the touchscreen functionality may be disabled in public areas during business hours and fully functional during closed hours, allowing employee-only use. Display duration may also be configured in EcoStruxure Building Operation software ranging from always on to only on for a few seconds after a touch.

Touchscreen Operation

Default View

The touchscreen user interface displays applicable sensor outputs (Temp, RH, CO₂ values), heating/cooling status, time, Eco mode (if active), and menu button. The front screen and menu screen are configurable to allow control of primary functions.



The default setting for the front screen includes the Temperature Setpoint Adjustment button and integrator's submenu.



The default setting for the menu screen includes buttons for the Fan Speed, Fahrenheit/Celsius mode, Unoccupied mode and HVAC modes.

Note: During firmware updates, the display may appear to be off. Please allow five minutes for this process to complete before disconnecting the sensor. This may also occur when the sensor is first connected to a controller.

Configurable Buttons



Temperature Setpoint Adjustment



Fahrenheit/Celsius Mode



Energy Saving Scene



Lighting Menu or Toggle Switch



HVAC Modes



Perimeter Scene



Blinds Menu or Toggle Switch



Integrator's Submenu



Meeting Scene



Moments or Scenes Menu



Occupied Scene



Projector Scene



Fan Speed



Vacant Scene



Occupied Mode

Touchscreen Operation (cont.) Front Screen Icon Configuration



1 button

2 buttons

3 buttons

4 buttons

In EBO, the user chooses one of the eight primary functions to populate the first position on the activated menu.

Menu Screen Configuration

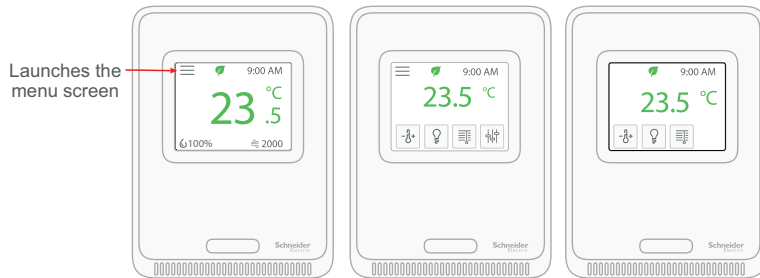

Returns to default screen

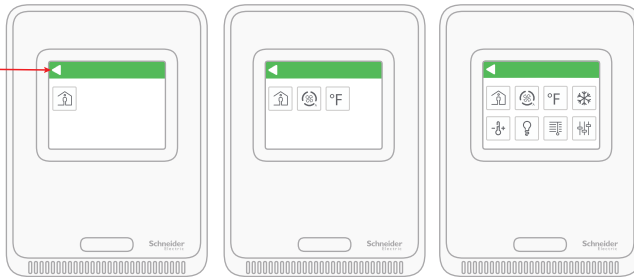

1 buttons

3 buttons

8 buttons

Touchscreen Operation (cont.) Icon Button Functions

Temperature Setpoint Adjustment



Press the thermometer icon to access the setpoint change menu.

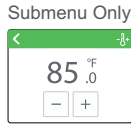

Press the arrow or wait 3 seconds to confirm and send a choice.

Lighting Menu or Toggle Switch



Press the lightbulb icon to access the lighting menu.

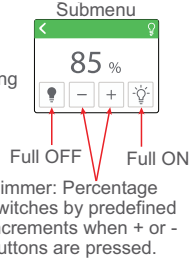

Single-press option: This single button is toggle-able.

- Turn light off
- Turn light on

Fan Speed



Press the fan icon to access the fan speed menu.

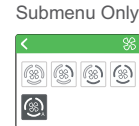

Other permutations:

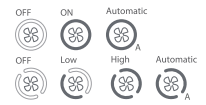

Blinds Menu or Toggle Switch



Press the blinds icon to access the blinds menu.



Single-press option: This single button is toggle-able (as an option for single-press open/close).

- Close (100%)
- Open (0%)
- Close (100%)
- Open (0%)

Moments or Scenes Menu



Press the settings icon to access the scenes menu.

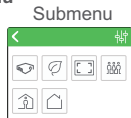

Single-press option: Any of these 'moments'/'scenes' are made available as a single-press function appearing outside the Moments menu contained on the Front menu.

- Activate projector scene

Example: Turn projector on, close blinds & dim lights to 20%.

Fahrenheit/Celsius Switch



Toggle to change temperature units.

Single Press Only

- Changes units to Fahrenheit when pressed.
- Changes units to Celsius when pressed.

HVAC Modes



Press the snowflake/heat icon to access the HVAC mode menu.

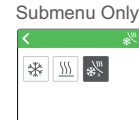

- Changes mode to Cooling mode.
- Changes mode to Heating mode.
- Changes mode to Automatic or shows automatic state.

Integrator's Submenu



Press this icon to access the integrator's menu. Defaults to the right-most button on the home screen.

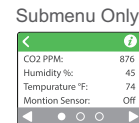

Occupied Mode



Press the occupied mode icon to access the setpoint change menu.

Single Press Only

- Call for change in schedule
- Shows the temporary state or call for end of special state

Touchscreen with Off-Screen Light and Blind Control Operation

Two-Button Models

Two-button models include fixed light on and off with dimming buttons.



Lights OFF/
Dimmer down



Lights ON/
Dimmer up



SXWSC2XSELXW



SXWSC2PSELXW
with Occupancy Sensor

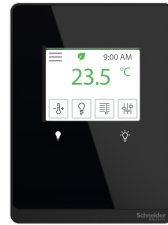

SXWSC2XSELXB

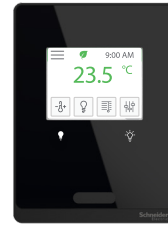

SXWSC2PSELXB
with Occupancy Sensor

Four-Button Models

Four-button models include the lighting buttons described above plus fixed blind open and close with adjustment buttons.



Close blinds/
Adjust close



Open blinds/
Adjust open



SXWSC4XSELXW



SXWSC4PSELXW
with Occupancy Sensor

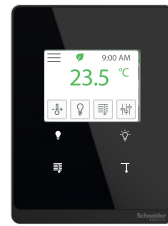

SXWSC4XSELXB

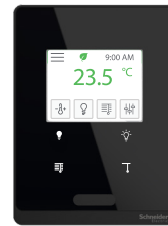

SXWSC4PSELXB
with Occupancy Sensor

Off-Screen Lighting Button Operation

Light On Button



Short Press

Display changes to lighting submenu with status. Lights in room go to 100%.

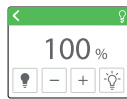

Long Press

Display changes to lighting submenu with status. Lighting percentage increases until button is released. Display provides level indication.

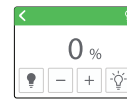

Starting state display example

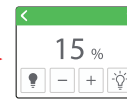

Button released

Light Off Button



Short Press

Display changes to lighting submenu with status. Lights in room go to 0%.

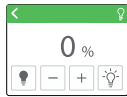

Long Press

Display changes to lighting submenu with status. Lighting percentage decreases until button is released. Display provides level indication.



Starting state display example

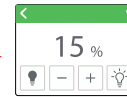

Button released

Off-Screen Blinds Button Operation

Open Blinds Button



Short Press

Display changes to Blinds submenu with status. Blinds in room go to 0%.



Long Press

Display changes to Blinds submenu with status. Blinds percentage decreases until button is released. Display provides level indication.



Starting state display example

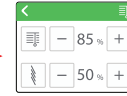

Button released

Close Blinds Button



Short Press

Display changes to Blinds submenu with status. Blinds in room go to 100%.



Long Press

Display changes to Blinds submenu with status. Blinds percentage increases until button is released. Display provides level indication.



Starting state display example

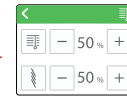

Button released

China RoHS Compliance Information Environment-Friendly Use Period (EFUP) Table

部件名称	有害物质 - Hazardous Substances					
Part Name	铅 (Pb)	汞 (Hg)	镉 (Cd)	六价铬 (Cr (VI))	多溴联苯 (PBB)	多溴二苯醚 (PBDE)
电子件 Electronic	X	O	O	O	O	O

本表格依据SJ/T11364的规定编制。

O: 表示该有害物质在该部件所有均质材料中的含量均在GB/T 26572规定的限量要求以下。

X: 表示该有害物质至少在该部件的某一均质材料中的含量超出GB/T 26572规定的限量要求。

(企业可在此处，根据实际情况对上表中打“X”的技术原因进行进一步说明。)

This table is made according to SJ/T 11364.

O: indicates that the concentration of hazardous substance in all of the homogeneous materials for this part is below the limit as stipulated in GB/T 26572.

X: indicates that concentration of hazardous substance in at least one of the homogeneous materials used for this part is above the limit as stipulated in GB/T 26572

Z000057-0B