

Digital Timer H5CC

New and improved design for easier use, programming, maintenance and user feedback. The improved user interface is intuitive and offers better overall visibility. Replacement time notification function notifies the user of potential preventive maintenance.



NEW

Basic Features

- The white-color display offers better visual clarity and visibility, and the color universal design is used.
- Up/Down Keys are provided for all six digits, which reduces the number of button operations during setup and other processes.
- An easy operation is realized by the operation guide on which each key lights up.
- The progress can be easily understood at one glance from the status indicators of the present value.
- The body depth of all models with screw terminals has been reduced to 59 mm.

Safety and Reliability

- The replacement time is notified in advance by predicting the service life.
 - The power supply circuit and input circuits are isolated except some models*, and therefore, there is no need of any wiring restrictions.
 - The free warranty period is three years.
- * They are not isolated for model H5CC-□F.

For the most recent information on models that have been certified for safety standards, refer to your OMRON website.

Refer to *Safety Precautions* on page 39.

Other Features

- Follows the ratings, characteristics, and functionality of the H5CX-□-N.
- Equipped with the Output ON/OFF Inversion Function.

Features

Basic Features

Better visual feedback and operation

The white-color display offers better visual clarity and visibility, and the color universal design is used. The keys of all six digits can be operated up/down for easier use. The LED indicator of the operable keys lights up to support setup.

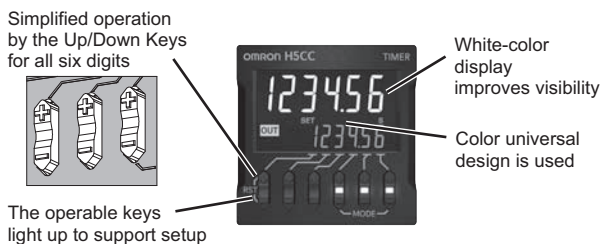

Status Notification by Status Indicator

The status can be indicated by the ratio of the present value or the measurement value to the set value, which makes it easy to understand the status.

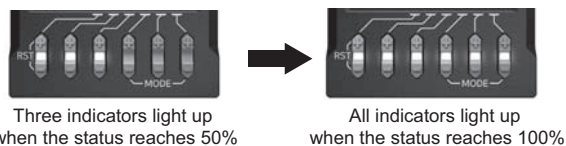

Shortened Body

The body depth of all models with screw terminals has been reduced to 59 mm, which contributes to thinner control panels!

- Models with Screw Terminals: 59 mm
- Models with Sockets: 63.7 mm (case dimension)

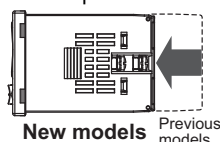

Safety and Reliability

Notification of Replacement Time

The service life prerequisites of the Timer include the relay output count and the deterioration of the electrolytic capacitors. In the H5CC, in addition to the relay output count, an alarm is displayed when the deterioration of electrolytic capacitors due to the cumulative run time reaches the standard value, and planned maintenance is supported.

Note: For details, refer to *Replacement Time Notification Function* on page 37.

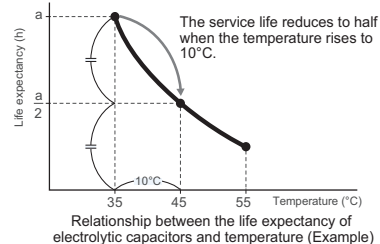

Isolated Power Supply and Input Circuits

Power supply circuit and input circuits are isolated* for safety and reliability. Previous non-isolated timers had wiring restrictions and could be damaged if wired incorrectly. The H5CC removes these worries.

* The H5CC-A11F does not isolate power supply circuit and input circuits.

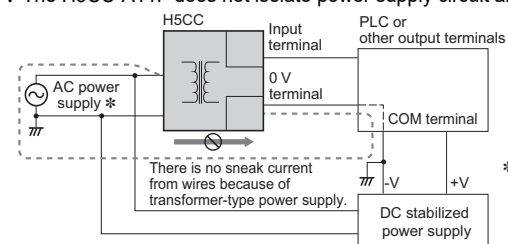

* Grounding of AC power supply implies grounding at the commercial power supply side.

Other Features

Equipped with a Key Protect Function

Any abnormality in the device due to malfunctioning or setting errors can be prevented.

Follows the Ratings, Characteristics, and Functionality of the H5CX-□-N

The H5CC follows the ratings, characteristics, and functionality of the H5CX-□-N.

Output ON/OFF Inversion Function

Conventionally, the output turns ON when the set value is reached, however, when this function is used, the output can be turned OFF when the set value is reached. As a result, the man-hours involved in checking the wiring can be reduced.

Reset Operation

To prevent operational errors, reset by pressing and holding RST keys (+ and - on the left). Then, when the reset is enabled, you will be visually guided by blinking LEDs. Note: For details, refer to *Nomenclature* on page 11.

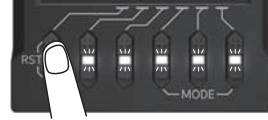

Model Number Structure

Model Configuration

H5CC Series

Type		Standard Type H5CC-A Series			
Model		H5CC-A□	H5CC-AU□	H5CC-A11□	H5CC-AWSD
Function	Timer	Yes			No
	Twin Timer	Yes			No
	Two-stage settings/ forecast output	No			Yes
Operating modes		Timer: 15 modes Twin Timer: 4 modes			Timer: 2 modes
Input		NPN/PNP input (For the H5CC-A11F, only NPN input is available.)			
External connections		Screw terminal block		11-pin socket	Screw terminal block
External power supply		None	Provided	None	
Instantaneous contact		None			
Gate input		Supported			
Power supply voltage		100 to 240 VAC, 12 to 48 VDC/24 VAC, 24 to 240 VDC/VAC (only for the H5CC-□F)			12 to 48 VDC/24 VAC

Type		Economy Type H5CC-L Series	
Model		H5CC-L8□	H5CC-L8E□
Function	Timer	Yes	
	Twin Timer	Yes	
	Two-stage settings/ forecast output	No	
Operating modes		Timer: 15 modes Twin Timer: 4 modes	Timer: 4 modes Twin Timer: 2 modes
Input		NPN input	None
External connections		8-pin socket	
External power supply		None	
Instantaneous contact		None	Provided
Gate input		Not supported	
Power supply voltage		100 to 240 VAC, 12 to 48 VDC/24 VAC, 24 to 240 VDC/VAC (only for the H5CC-□F)	

Model Number Legend (Not all possible combinations of functions are available.)

H5CC-□□□□□
 1 2 3 4 5

1. Type

Symbol	Meaning
A	Standard type
L	Economy type

2. Terminal structure

Symbol	Meaning
None	Screw terminals
8	8-pin socket
11	11-pin socket

3. Settings

Symbol	Meaning
None	One stage
W	Two stages

4. Output type

Symbol	Meaning
None	Contact output (time-limit SPDT)
E	Contact output (time-limit SPDT + instantaneous SPDT) *
U	Contact output (time-limit SPDT) + transistor output (time-limit SPST) (with external power supply)
S	Transistor output

5. Supply voltage

Symbol	Meaning
None	100 to 240 VAC 50/60 Hz
D	12 to 48 VDC/24 VAC 50/60 Hz
F	24 to 240 VDC/24 to 240 VAC 50/60 Hz

* Can be used as a time-limit DPDT output.

Note: Estimates can be provided for coatings and other specifications that are not given in the datasheet. Ask your OMRON representative for details.

Ordering Information

Type	Time ranges	Operating modes	External connections	Inputs	Outputs	Power supply voltage	Models
H5CC-A	0.001 to 999.999 s 0.01 to 9999.99 s 0.1 to 99999.9 s 1 to 999999 s 1s to 99 h 59 min 59 s 0.1 to 99999.9 min 1 to 999999 min 1 min to 9999 h 59 min 0.1 to 99999.9 h 1 to 999999 h	A: Signal ON delay I F-1: Cumulative (Timer does not reset when power comes ON.)	Screw terminal blocks	Signal, Reset, Gate (NPN/PNP inputs)	Transistor output (DPST)	12 to 48 VDC/24 VAC	H5CC-AWSD
		<Timer Mode> A: Signal ON delay I A-1: Signal ON delay II A-2: Power ON delay I A-3: Power ON delay II b: Flicker I b-1: Flicker II b-5: One-shot flicker C: Signal ON/OFF delay I d: Signal OFF delay I E: Interval F: Cumulative G: Signal ON/OFF delay II H: Signal OFF delay II Z: ON/OFF-duty-adjustable flicker S: Stopwatch <Twin Timer Mode> toff: Flicker OFF start I ton: Flicker ON start I toff-1: Flicker OFF start II ton-1: Flicker ON start II	Screw terminal blocks	Signal, Reset, Gate (NPN/PNP inputs)	Contact output (time-limit SPDT)	100 to 240 VAC	H5CC-A
					12 to 48 VDC/24 VAC	H5CC-AD	
					Transistor output (SPST)	100 to 240 VAC	H5CC-AS
					12 to 48 VDC/24 VAC	H5CC-ASD	
					Contact output (SPDT) + transistor output (SPST)	100 to 240 VAC	H5CC-AU
					12 to 48 VDC/24 VAC	H5CC-AUD	
					Contact output (time-limit SPDT)	100 to 240 VAC	H5CC-A11
					12 to 48 VDC/24 VAC	H5CC-A11D	
					Transistor output (SPST)	100 to 240 VAC	H5CC-A11S
12 to 48 VDC/24 VAC	H5CC-A11SD						
Signal, Reset, Gate (NPN inputs)	Contact output (time-limit SPDT)	24 to 240 VDC/VAC	H5CC-A11F				
H5CC-L	0.001 to 999.999 s 0.01 to 9999.99 s 0.1 to 99999.9 s 1 to 999999 s 1s to 99 h 59 min 59 s 0.1 to 99999.9 min 1 to 999999 min 1 min to 9999 h 59 min 0.1 to 99999.9 h 1 to 999999 h	<Timer Mode> A-2: Power ON delay I b: Flicker I E: Interval Z: ON/OFF-duty-adjustable flicker <Twin Timer Mode> toff: Flicker OFF start I ton: Flicker ON start I	8-pin socket	None	Contact output (time-limit SPDT)	100 to 240 VAC	H5CC-L8
					12 to 48 VDC/24 VAC	H5CC-L8D	
					Transistor output (SPST)	100 to 240 VAC	H5CC-L8S
					12 to 48 VDC/24 VAC	H5CC-L8SD	
					Contact output (time-limit SPDT + instantaneous SPDT) Models with instantaneous contact outputs	100 to 240 VAC	H5CC-L8E
					12 to 48 VDC/24 VAC	H5CC-L8ED	
					24 to 240 VDC/VAC	H5CC-L8EF	

Accessories (Order Separately)

Soft Cover

Models	Remarks	Page
Y92A-48F1		13

Hard Cover

Models	Remarks	Page
Y92A-48		13

Flush Mounting Adapter

Models	Remarks	Page
Y92F-30	Included with models with terminal blocks.	13
Y92F-45	Use this Adapter to install the Timer in a cutout previously made for a DIN 72 x 72 mm device (panel cutout: 68 x 68 mm).	
Y92F-38	Use for replacement of the 81-dia. hole device (H3AM).	

Waterproof Packing

Models	Remarks	Page
Y92S-P6	Included with models with terminal blocks.	13

Connection Sockets

Models	Type	Connectable Timers	Remarks	Page
P2CF-08	Front Connecting Socket	H5CC-L8□	Round crimp terminals cannot be used. Use forked crimp terminals.	14
P2CF-08-E	Front Connecting Socket (Finger-safe Type)			
P2CF-11	Front Connecting Socket	H5CC-A11□	Round crimp terminals cannot be used. Use forked crimp terminals.	
P2CF-11-E	Front Connecting Socket (Finger-safe Type)			
P3G-08	Back Connecting Socket	H5CC-L8□	A Y92A-48G Terminal Cover can be used with the Socket to enable finger protection.	
P3GA-11		H5CC-A11□		

Terminal Covers for P3G-08 and P3GA-11 Back Connecting Sockets

Models	Remarks	Page
Y92A-48G		15



H5CC Digital Timers

- Equipped with a replacement time notification function.
- The white-color display further improves visibility, and the color universal design is used. The Up/Down Keys make it easier to use the Timer.
- Compatible with the ratings, characteristics, and function of the H5CX-□-N.



For the most recent information on models that have been certified for safety standards, refer to your OMRON website.

Specifications

Ratings

Item	Models	H5CC-A□	H5CC-A11□	H5CC-L8□
Classification		Standard Type		Economy Type
Ratings	Power supply voltage *1	<ul style="list-style-type: none"> • 100 to 240 VAC 50/60 Hz • 12 to 48 VDC/24 VAC 50/60 Hz • 24 to 240 VDC/24 to 240 VAC 50/60 Hz (only for the H5CC-□F) 		
	Allowable voltage fluctuation range	85% to 110% of rated supply voltage (90% to 110% at 12 to 48 VDC)		
	Power consumption	Approx. 6.5 VA at 100 to 240 VAC Approx. 5.4 VA/3.2 W at 24 VAC/12 to 48 VDC Approx. 5.6 VA/2.7 W at 24 to 240 VAC/24 to 240 VDC *2		
Mounting method		Flush mounting	Flush mounting, surface mounting, DIN track mounting	
External connections		Screw terminals	11-pin socket	8-pin socket
Degree of protection		IEC IP66 for panel surface only and when Y92S-P6 Waterproof Packing is used		
Digits		6 digits		
Time ranges		0.001 s to 999.999 s, 0.01 s to 9999.99 s, 0.1 s to 99999.9 s, 1 s to 999999 s, 1 s to 99 h 59 min 59 s, 0.1 m to 99999.9 min, 1 min to 999999 min, 1 min to 9999 h 59 min, 0.1 h to 99999.9 h, 1 h to 999999 h		
Timer mode		Elapsed time (Up), remaining time (Down) (selectable)		
Inputs	Input signals	Signal, Reset, Gate		Signal, Reset (no inputs on the H5CC-L8E□)
	Input method	No-voltage (NPN) input/voltage (PNP) input (switchable) (only no-voltage input is available for the H5CC-A11F) No-voltage input ON impedance: 1 kΩ max. (Leakage current: approx. 12 mA when 0 Ω) (Approx. 1 mA for the H5CC-A11F) ON residual voltage: 3 V max. (1 V max. for the H5CC-A11F) OFF impedance: 100 kΩ min. Voltage input High (logic) level: 4.5 to 30 VDC Low (logic) level: 0 to 2 VDC (Input resistance: approx. 4.7 kΩ)		No-voltage input ON-impedance: 1 kΩ max. (Leakage current: 12 mA when 0 Ω) ON residual voltage: 3 V max. OFF impedance: 100 kΩ min.
	Signal, reset, gate	Minimum input signal width: 1 or 20 ms (selectable, 50 ms for the H5CC-A11F)		
Reset system		Power reset (depending on output mode), external reset, manual reset, automatic reset (depending on output mode)		
Power reset		Minimum power-opening time: 0.5 s (except for A-3, b-1, F, ton-1, and toff-1 mode) (1 s for the H5CC-AU□ and 0.1 s for the H5CC-□F)		
Reset voltage		10% max. of power supply voltage		
Sensor waiting time		250 ms max. (Control output is turned OFF and no input is accepted during sensor waiting time.)		
Output	Output modes	A: Signal ON delay I, A-1: Signal ON delay II, A2: Power ON delay I, A3: Power ON delay II, b: Flicker I, b-1: Flicker II, b-5: One-shot flicker, C: Signal ON/OFF delay I, d: Signal OFF delay I, E: Interval, F: Cumulative, G: Signal ON/OFF delay II, H: Signal OFF delay II, Z: ON/OFF-duty-adjustable flicker, S: Stopwatch, toff: Flicker OFF start I, ton: Flicker ON start I, toff-1: Flicker OFF start II, ton-1: Flicker ON start II		H5CC-L8E□ A2: Power ON delay I, b: Flicker I, E: Interval, Z: ON/OFF-duty-adjustable flicker, toff: Flicker OFF start I, ton: Flicker ON start I
	One-shot time	0.01 to 99.99 s		
	Control output	<ul style="list-style-type: none"> • Models with Contact Outputs 5 A at 250 VAC/30 VDC, resistive load (cos =1) Minimum applicable load: 10 mA at 5 VDC (failure level: P, reference value) Contact materials: AgSnIn • Transistor output: NPN open collector, 100 mA at 30 VDC max., residual voltage: 1.5 VDC max. (Approx. 1 V), Leakage current: 0.1 mA max. 		
External power supply		12 VDC (±10%), 100 mA (only for the H5CC-AU□) Note. Refer to <i>Precautions for Correct Use</i> on page 41 for details.		
Display method *3		7-segment, negative transmissive LCD; Present value: 10-mm-high characters, white Set value: 6-mm-high characters, green	7-segment, negative transmissive LCD; Present value: 10-mm-high characters, white Set value: 6-mm-high characters, green	
Memory backup		No-volatile memory (overwrites: 100,000 times min.) that can store data for 10 years min.		
Operating temperature range		-10 to 55°C (-10 to 50°C if timers are mounted side by side) (with no icing or condensation)		
Storage temperature range		-25 to 70°C (with no icing or condensation)		
Operating humidity range		25% to 85%		
Case color		Black (N1.5)		
Attachments		Flush mounting adapter, waterproof packing, terminal cover	---	

*1. Do not use the output from an inverter as the power supply. The ripple must be 20% maximum for DC power.

*2. Inrush current will flow for a short time when the power supply is turned ON.

Inrush Current (Reference Values)

Voltage	Applied voltage	Inrush current (peak value)	Time
100 to 240 VAC	264 VAC	6.5 A	0.74 ms
12 to 48 VDC/24 VAC	26.4 VAC	13.6 A	0.88 ms
	52.8 VDC	12.9 A	0.80 ms
24 to 240 VDC/24 to 240 VAC	264 VAC	5.5 A	0.26 ms
	264 VDC	3.9 A	0.26 ms

*3. The display is lit only when the power is ON. Nothing is displayed when power is OFF.

H5CC

Item	Models	H5CC-AWSD
Classification		Digital Timer with two-stage setting, and forecast output
Ratings	Power supply voltage	12 to 48 VDC/24 VAC 50/60 Hz
	Allowable voltage fluctuation range	85% to 110% of rated supply voltage (90% to 110% at 12 to 48 VDC)
	Power consumption	Approx. 5.32 VA/3.17 W at 24 VAC/12 to 48 VDC *1
Mounting method		Flush mounting
External connections		Screw terminals
Degree of protection		IEC IP66 for panel surface only and when Y92S-P6 Waterproof Packing is used
Time range		0.001 s to 999.999 s, 0.01 s to 9999.99 s, 0.1 s to 99999.9 s, 1 s to 999999 s, 1 s to 99 h 59 min 59 s, 0.1 min to 99999.9 min, 1 min to 999999 min, 1 min to 9999 h 59 min, 0.1 h to 99999.9h, 1 h to 999999 h
Timer mode		Elapsed time (Up)
Inputs	Input signals	Signal, reset, gate
	Input method	No-voltage (NPN) input/voltage (PNP) input (switchable) No-voltage input ON impedance: 1 kΩ max. (Leakage current: 12 mA when 0 Ω) ON residual voltage: 3 V max. OFF impedance: 100 kΩ min. Voltage input High (logic) level: 4.5 to 30 VDC Low (logic) level: 0 to 2 VDC (Input resistance: approx. 4.7 kΩ)
	Signal, reset, gate	Minimum input signal width: 1 or 20 ms (selectable, same for all input)
Reset system		Power resets (only for A mode), external and manual reset
Power reset		Minimum power-opening time: 0.5 s (except for F-1 mode)
Reset voltage		10% max. of power supply voltage
Sensor waiting time		250 ms max. (Control output is turned OFF and no input is accepted during sensor waiting time.)
Outputs	Output modes	A, F-1
	Output type	Transistor output: NPN open collector, 100 mA at 30 VDC max. residual voltage: 1.5 VDC max. (Approx. 1 V) Leakage current: 0.1 mA max.
Display		7-segment, negative transmissive LCD; Present value: 10-mm-high characters, white Set value: 6-mm-high characters, green *2
Memory backup		No-volatile memory (overwrites: 100,000 times min.) that can store data for 10 years min.
Operating temperature range		-10 to 55°C (-10 to 50°C if timers are mounted side by side) (with no icing or condensation)
Storage temperature range		-25 to 70°C (with no icing or condensation)
Operating humidity range		25% to 85%
Case color		Black (N1.5)
Attachments		Waterproof packing, flush mounting adapter, terminal cover

*1. Inrush current will flow for a short time when the power supply is turned ON.
 Inrush Current (Reference Values)

Voltage	Applied voltage	Inrush current (peak value)	Time
12 to 48 VDC/24 VAC	52.8 VAC	13.6 A	0.88 ms
	42.8 VDC	12.9 A	0.80 ms

*2. The display is lit only when the power is ON. Nothing is displayed when power is OFF.

Characteristics

Accuracy of operating time and setting error (including temperature and voltage influences)		Power-ON start: $\pm 0.01\% \pm 0.05$ s max. *1 Signal start: $\pm 0.005\% \pm 0.03$ s max. *1 Signal start for transistor output model: $\pm 0.005\% \pm 3$ ms max. *1 *2 If the set value is within the sensor waiting time at startup the control output of the H5CC will not turn ON until the sensor waiting time passes. *1. The values are based on the set value. *2. The value is applied for a minimum input signal width of 1 ms.
Insulation resistance		100 M Ω min. (at 500 VDC) between current-carrying terminal and exposed non-current-carrying metal parts, between non-continuous contacts
Dielectric strength		2,900 VAC, 50/60 Hz for 1 min between current-carrying terminal and operating section 2,000 VAC, 50/60 Hz for 1 min between power supply and input circuits for models other than the H5CC-A11F and H5CC-L8E□ (1,500 VAC for 12 to 48 VDC/24 VAC) 1,500 VAC, 50/60 Hz for 1 min between control output, power supply, and input circuits (for models other than the H5CC-L8E□) for H5CC-□SD 2,000 VAC, 50/60 Hz for 1 min between control output, power supply, and input circuits (for models other than the H5CC-L8E□) for other models 1,000 VAC, 50/60 Hz for 1 min between non-continuous contacts
Impulse withstand voltage		5 kV (between power terminals) for 100 to 240 VAC, 1.0 kV for 24 VAC/12 to 48 VDC 7.4 kV (between current-carrying terminal and operating section)
Static immunity		Malfunction: 8 kV Destruction: 15 kV
Vibration resistance	Destruction	10 to 55 Hz with 0.75-mm single amplitude each in three directions for 2 h each
	Malfunction	10 to 55 Hz with 0.35-mm single amplitude each in three directions for 10 min each
Shock resistance	Destruction	300 m/s ² in three directions, three cycles
	Malfunction	100 m/s ² in three directions, three cycles
Life expectancy	Mechanical	10,000,000 operations min. (under no load at switching frequency of 1,800 operations/h and ambient temperature of 23°C)
	Electrical	100,000 operations min. (5 A at 250 VAC, resistive load at 1,800 operations/h and ambient temperature of 23°C) *
Weight		Approx. 115 g (Timer only)

* Refer to Electrical Life Test Curve.

Electrical Life Test Curve (Reference Values)

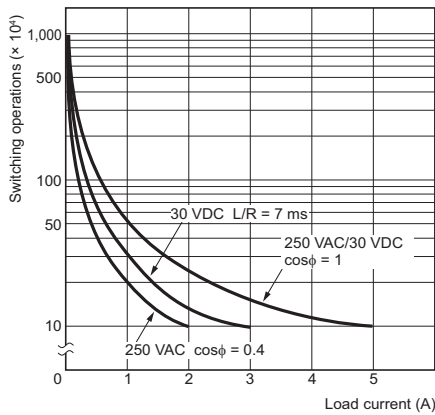

A maximum current of 0.15 A can be switched at 125 VDC (cosφ = 1)
and a maximum current of 0.1 A can be switched if L/R is 7 ms.
 In both cases, a life of 100,000 operations can be expected.

Applicable Standards

Approved safety standards	cULus (or cURus): UL508/CSA C22.2 No. 14 *1 Conforms to EN61812-1: Pollution degree 2/overvoltage category III B300 PILOT DUTY, 1/4 HP 120 VAC, 1/3 HP, 240 VAC, 5 A, 250 VAC/30 VDC resistive load VDE0106/P100 CCC: GB/T 14048.5 Pollution degree 2/overvoltage category III *2 RCM UKCA	
EMC	(EMI) Emission Enclosure: EN61812-1 EN55011 Group 1 class A Emission AC mains: EN55011 Group 1 class A (EMS) Immunity ESD: EN61812-1 EN61000-4-2: 4 kV contact discharge 8 kV air discharge Immunity RF-interference: EN61000-4-3: 10 V/m (Amplitude modulated, 80 MHz to 1 GHz); 3 V/m (Amplitude modulated, 1.4 G to 2 GHz); 1 V/m (Amplitude modulated, 2 G to 2.7 GHz); 10 V/m (Pulse-modulated, 900 MHz±5 MHz)	Immunity Conducted Disturbance: EN61000-4-6: 10 V (0.15 to 80 MHz) Immunity Burst: EN61000-4-4: 2 kV power-line; 1 kV I/O signal-line Immunity Surge: EN61000-4-5: 1 kV line to lines (power and output lines (relay outputs)); 2 kV line to ground (power and output lines (relay outputs)) Immunity Voltage Dip/Interruption: EN61000-4-11: Voltage Dip 1 cycle, 100% (rated voltage) 10/12 cycle, 60% (rated voltage) 25/30 cycle, 30% (rated voltage) Interruption 250/300 cycle, 100% (rated voltage)

*1. The following safety standards apply to models with sockets (H5CC-L8□/A11□).

cUL (Listing): Applicable when an OMRON P2CF(-E) Socket is used.

cUR (Recognition): Applicable when any other socket is used.

*2. CCC certification requirements

Rated operating voltage Ue Rated operating current Ie	Contact output: AC-15: Ue: 250 VAC, Ie: 3 A AC-13: Ue: 250 VAC, Ie: 5 A DC-13: Ue: 30 VDC, Ie: 0.5 A Transistor output: DC-13: Ue: 30 VDC, Ie: 0.1 A
Rated insulation voltage	250 V
Rated impulse withstand voltage (altitude: 2,000 m max.)	4 kV (at 240 VAC)
Conditional short-circuit current	1000 A

I/O Functions

For details, refer to the timing charts on page 20, page 31, and page 36.

Inputs *1	Start signal	Normally functions to start timing. In modes A-2 and A-3, disable timing. In mode S, starts and stops timing.	
	Reset	<ul style="list-style-type: none"> Resets present value. (In elapsed time mode, the present value returns to 0; in remaining time mode, the present value returns to the set value.) Count inputs are not accepted and control output turns OFF while reset input is ON. Reset indicator is lit while reset input is ON. 	
	Gate *2	Disables timing. (If a reset occurs while the gate input is ON, a reset will be performed.)	
Outputs	Control output (OUT)		
	Forecast value setting *3	Control output (OUT2)	Turns ON when the present value reaches the set value.
		Forecast output (OUT1)	Turns ON when the present value reaches the forecast value.
	Absolute value setting *3	Control output 2 (OUT2)	Turns ON when the present value reaches the set value 2.
Control output 1 (OUT1)		Turns ON when the present value reaches the set value 1.	

*1. The H5CC-L8E□ does not have an input.

*2. The H5CC-L□ does not have a gate input.

*3. For the H5CC-AWSD.

Response Delay Time When Resetting (Transistor Output)

The following table shows the output delay time from when the reset signal is input until the output is turned OFF.

(Reference value)

Minimum reset signal width	Output delay time
1 ms	0.58 to 0.78 ms
20 ms	13.7 to 17.2 ms

Connections

Block Diagram

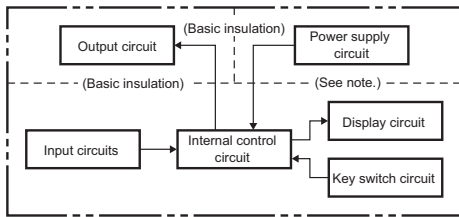

Note: Basic insulation is provided between the power supply circuit and the input circuits. However, basic insulation is not provided in the H5CC-□F.

Terminal Arrangement

Confirm that the power supply meets specifications before use.

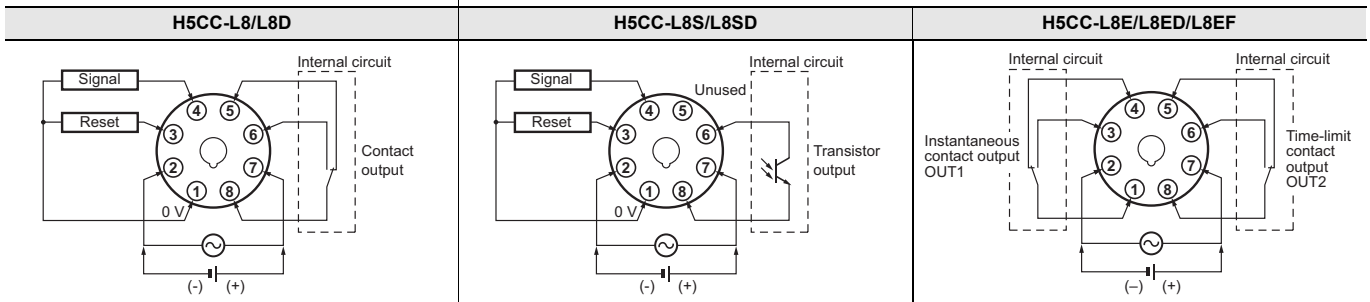
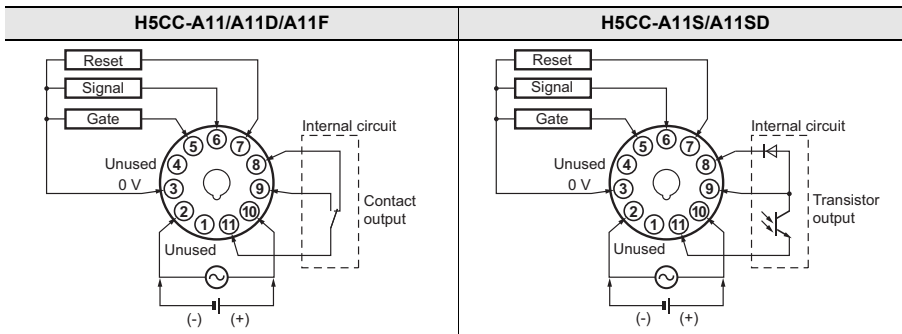
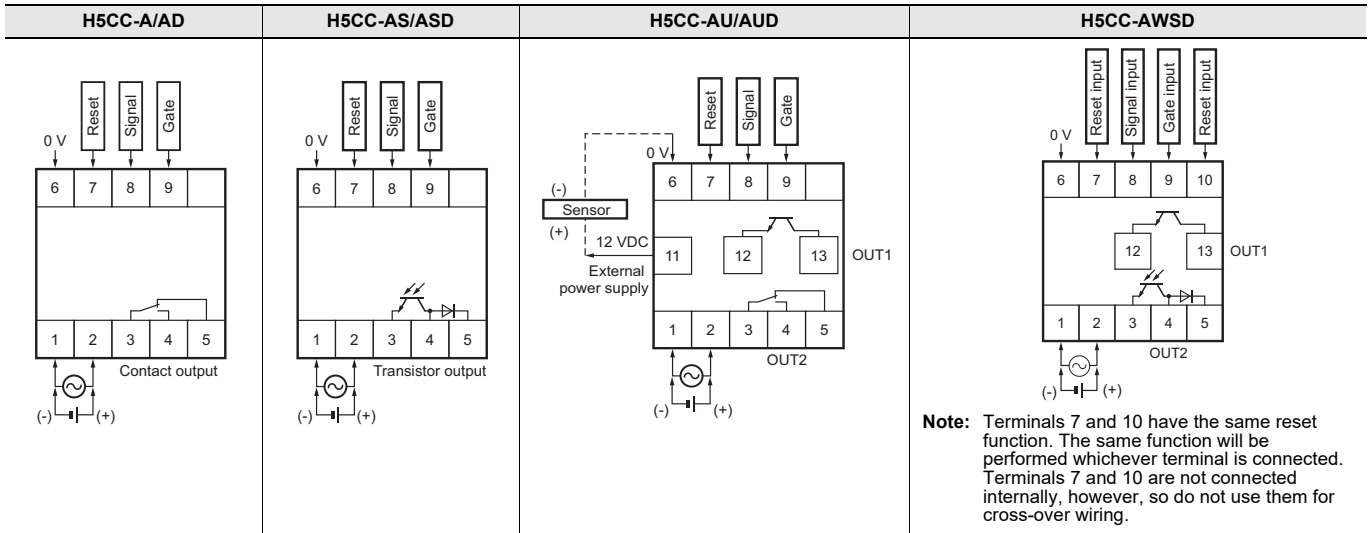

Note: Do not connect unused terminals as relay terminals.

Transistor Output

- The transistor output of the H5CC is insulated from the internal circuitry by a photocoupler, so the transistor output can be used as both NPN and PNP output.

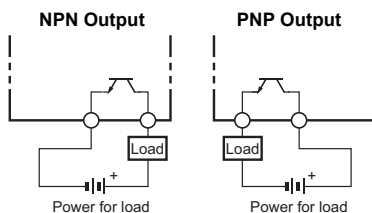

- The diode connected to the collector of the output transistor is used to absorb inverted voltage that is generated when an inductive load is connected to the H5CC.

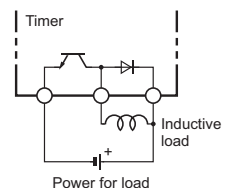

Input Circuits

Signal, Reset, and Gate Input

No-voltage Inputs (NPN Inputs)
Other than the H5CC-A11F

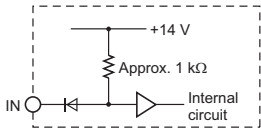

H5CC-A11F

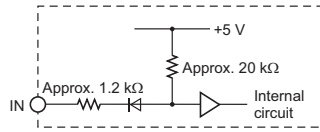

Voltage Inputs (PNP Inputs)

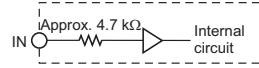

Input Connections

The inputs of the H5CC are no-voltage (short-circuit or open) inputs or voltage inputs. (Reverse connection is not possible because there is polarity.) (The inputs of the H5CC-A11F/L8□ are no-voltage inputs only. The H5CC-L8E□ does not have an input.)

No-voltage Inputs (NPN Inputs)

Open Collector

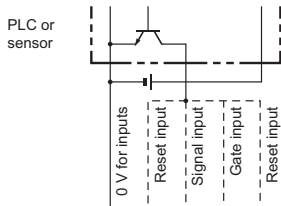

H5CC-A□	6	7	8	9	-
H5CC-AWSD	6	7	8	9	10
H5CC-A11□	3	7	6	5	-
H5CC-L8□	1	3	4	-	-

Note: Operate with transistor ON

Voltage Output

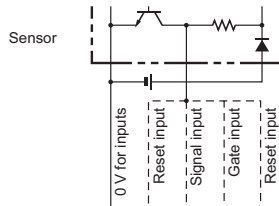

H5CC-A□	6	7	8	9	-
H5CC-AWSD	6	7	8	9	10
H5CC-A11□	3	7	6	5	-
H5CC-L8□	1	3	4	-	-

Note: Operate with transistor ON

Contact Input

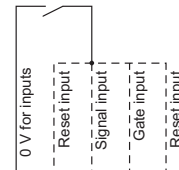

H5CC-A□	6	7	8	9	-
H5CC-AWSD	6	7	8	9	10
H5CC-A11□	3	7	6	5	-
H5CC-L8□	1	3	4	-	-

Note: Operate with relay ON

DC Two-wire Sensor

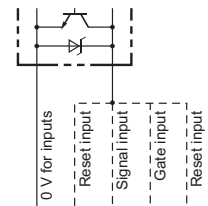

H5CC-A□	6	7	8	9	-
H5CC-AWSD	6	7	8	9	10
H5CC-A11□	3	7	6	5	-
H5CC-L8□	1	3	4	-	-

Note: Operate with transistor ON

No-voltage Input Signal Levels

No-contact input	Short-circuit level (Transistor ON) <ul style="list-style-type: none"> Residual voltage: 3.0 VDC max. (1.0 VDC max. for the H5CC-A11F) Impedance when ON: 1 kΩ max. (The leakage current is approx. 12 mA when the impedance is 0 Ω.) (Approx. 1 mA for the H5CC-A11F)
	Open level (transistor OFF) <ul style="list-style-type: none"> OFF impedance: 100 kΩ min.
Contact input	Use contacts which can adequately switch 5 mA at 10 V.

* The DC voltage must be 30 VDC max.

Applicable Two-wire Sensor

- Leakage current: 1.5 mA max.
- Switching capacity: 5 mA min.
- Residual voltage: 3.0 VDC max. (1.0 VDC max. for the H5CC-A11F)
- Operating voltage: 10 VDC

Note: When an AC input signal will be input to signal, reset, and gate inputs. Input the signal via a relay, etc. because AC input cannot be input directly.

(Example)
Connection example

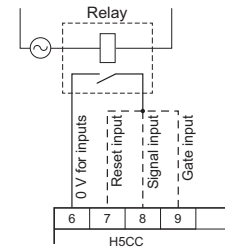

Voltage Inputs (PNP Inputs) Note: The inputs of the H5CC-A11F/L8□ are no-voltage inputs only.

No-contact Input (NPN Transistor)

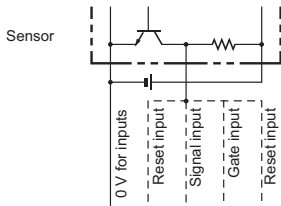

H5CC-A□	6	7	8	9	-
H5CC-AWSD	6	7	8	9	10
H5CC-A11□	3	7	6	5	-

Note: Operate with transistor OFF

No-contact Input (PNP Transistor)

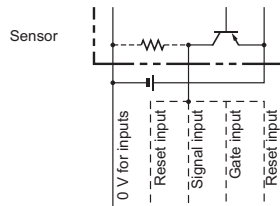

H5CC-A□	6	7	8	9	-
H5CC-AWSD	6	7	8	9	10
H5CC-A11□	3	7	6	5	-

Note: Operate with transistor ON

Contact Input

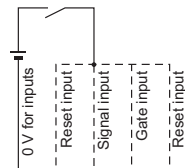

H5CC-A□	6	7	8	9	-
H5CC-AWSD	6	7	8	9	10
H5CC-A11□	3	7	6	5	-

Note: Operate with relay ON

Voltage Input Signal Levels

High level (Input ON): 4.5 to 30 VDC	* The DC voltage must be 30 VDC max. * Input resistance: Approx. 4.7 kΩ
Low level (Input OFF): 0 to 2 VDC	

Nomenclature

Display Section

- 1. Key Protection Indicator** (yellow)
Lit when the key protect switch is ON.
- 2. Control Output Indicator** (yellow)
Forecast value setting (for the H5CC-AWSD)
Forecast output ON: OUT 1 is lit.
Control output ON: OUT 2 is lit.
Absolute value setting (for the H5CC-AWSD)
Control output 1 ON: OUT 1 is lit.
Control output 2 ON: OUT 2 is lit.
- 3. Reset Indicator** (yellow)
Lit when the reset input or Reset Key is ON.
- 4. Present Value Display** (Main display)
(Character height: 10 mm, white)
- 5. Time Unit Indicators** (green)
(If the time range is 0 min, 0 h, 0.0 h, or 0 h 0 min, these indicators flash to indicate timing operation.)
- 6. Set Value Display** (Sub-display)
(Character height: 6 mm, green)
- 7. Set Value 1, 2 Indicator** (green)

Character Size
for Main Display

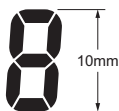

Character Size
for Sub-display

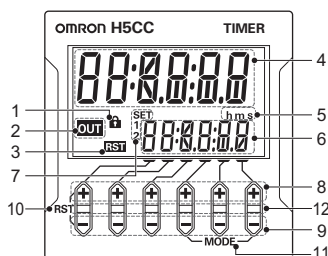

Operation Keys

- 8. Up Keys (UP1 to UP6)**
(UP1, 2, 3, 4, 5, 6 from right to left)
- 9. Down Keys (DW1 to DW6)**
(DW1, 2, 3, 4, 5, 6 from right to left)

10. Reset Operation (UP6+DW6) *

- Press RST keys (UP6+DW6) simultaneously for at least one second.
- LED on each key starts blinking.
Do not release the keys until the LED starts blinking. Otherwise the setting value may change. If not blink, that is because the keys are not pressed simultaneously. In this case, release the keys after pressing for at least 1 second, and restart from 1.
- Press and hold until the LED turns off.
If you release the keys while blinking, the reset operation will be interrupted.



11. Mode Operation (UP1+UP3 or DW1+DW3)

<Change of setting item>

- Press MODE keys (UP1+UP3 or DW1+DW3) simultaneously to switch setting items.

<Move to Function Setting Mode>

- Press MODE key (UP1+UP3 or DW1+DW3) for at least 2 seconds simultaneously.
LEDs on UP1 (DW1) and UP3 (DW3) key start blinking.
Do not release the keys until the LEDs start blinking. Otherwise the setting value may change. If not blink, that is because the keys are not pressed simultaneously. In this case, release the keys after pressing for at least one second, and restart from 1.
- Press and hold until the LED turns off. If you release the keys during blinking, the mode will not be moved to Function Setting Mode.

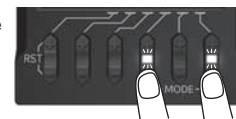

DW1+DW3

12. Status indicator

<When Run mode is not selected.>

- When the indicator display mode is ON
The ratio of the measurement value to the set value is displayed from 0 to 100%.
- When the indicator display mode is all off or all lit
All off or all lit display.

Note. When you press the Up Key or the Down Key, the status indicator display goes off, and the pressed key lights up or blinks.

<When Function Setting Mode is not selected>

- The keys that can be set light up for notification.

Switches

13. Key-protect Switch

(Default setting) OFF (Disable) ← → ON (Enable)

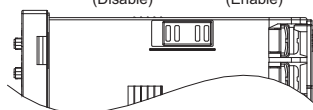

H5CC

Dimensions

(Unit: mm)

Digital Timers

Digital Timers

H5CC-AI/-AD/-AS/-ASD/-AU/-AUD/-AWSD (Flush Mounting Models)

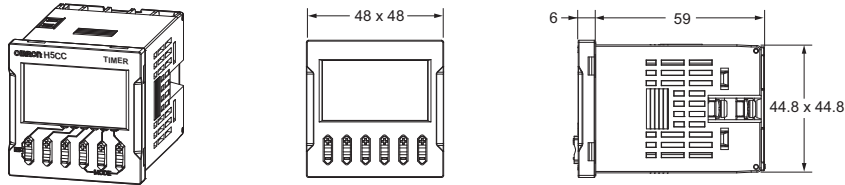

Note: M3.5 terminal screw
(effective length: 6 mm)

H5CC-A11/-A11D/-A11F/-A11S/-A11SD (Flush Mounting/Surface Mounting Models)

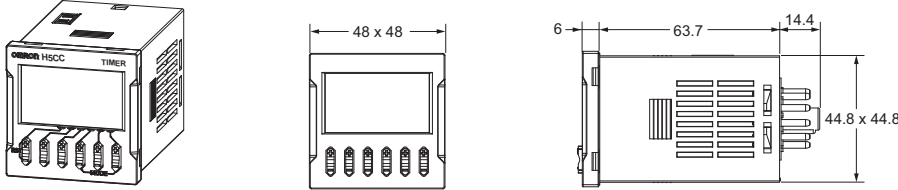

H5CC-L8/-L8D/-L8S/-L8SD/-L8E/-L8ED/-L8EF (Flush Mounting/Surface Mounting Models)

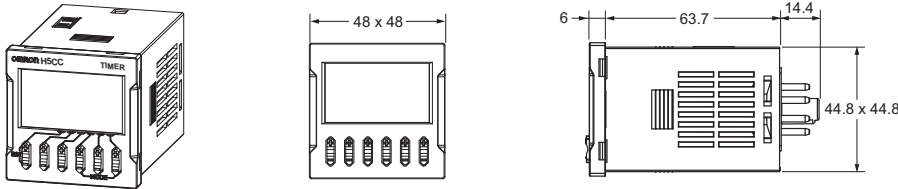

Dimensions with Flush Mounting Adapter

H5CC-AI/-AD/-AS/-ASD/-AU/-AUD/-AWSD (Flush Mounting Models) (Provided with Adapter and Waterproof Packing)

Panel Cutouts

Panel cutouts are as shown below. (According to DIN 43700.)

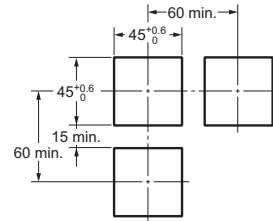
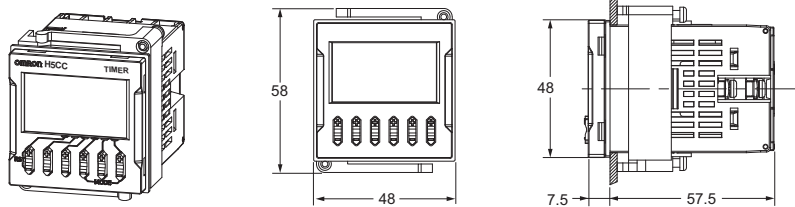

H5CC-L8/-L8D/-L8S/-L8SD/-L8E/-L8ED/-L8DF/ -A11/-A11D/-A11F/-A11S/-A11SD (Flush Mounting Models) (Adapter and Waterproof Packing Ordered Separately)

Note: 1. The mounting panel thickness should be 1 to 5 mm.

Note: 2. To allow easier operation, it is recommended that Adapters be mounted so that the gap between sides with hooks is at least 15 mm (i.e., with the panel cutouts separated by at least 60 mm).

Note: 3. It is possible to horizontally mount Timers side by side. Attach the Flush Mounting Adapters so that the surfaces without hooks are on the sides of the Timers. If they are mounted side-by-side, water resistance will be lost.

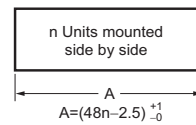
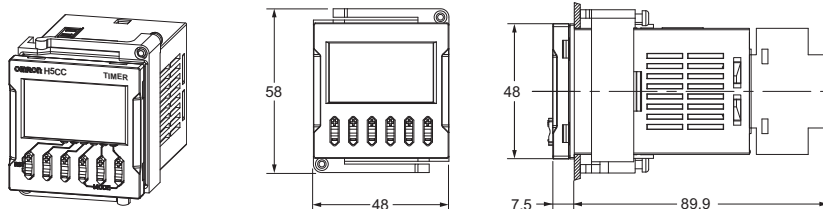

With Y92A-48F1 attached.
 $A = \{48n - 2.5 + (n-1) \times 4\} \begin{smallmatrix} +1 \\ -0 \end{smallmatrix}$
With Y92A-48 attached.
 $A = \{51n - 5.5\} \begin{smallmatrix} +1 \\ -0 \end{smallmatrix}$

Dimensions with Front Connecting Socket

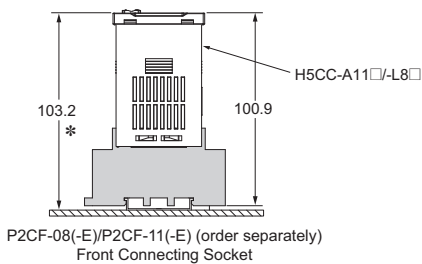

* These dimensions depend on the kind of DIN track and Sockets.
(Reference value.)

Accessories (Order Separately)

Note: Depending on the operating environment, the condition of resin products may deteriorate, and may shrink or become harder. Therefore, it is recommended that resin products are replaced regularly.

Soft Cover Y92A-48F1

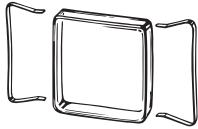

The Soft Cover is attached by inserting the front part between the holding clips.

Hard Cover Y92A-48

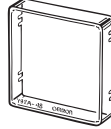

Protecting the Timer in Environments Subject to Oil

The H5CC's panel surface is water-resistant (IP□6) and so even if drops of water penetrate the gaps between the keys, there will be no adverse effect on internal circuits. If, however, there is a possibility of oil being present on the operator's hands, use the Soft Cover. The Soft Cover ensures protection equivalent to IP54 against oil. Do not, however, use the H5CC in locations where the front section would come in direct contact with oil.

Waterproof Packing

Y92S-P6

* The Waterproof Packing is included with models with screw terminals.

Order the Waterproof Packing separately if it is lost or damaged.

The Waterproof Packing can be used to achieve IP66 protection.

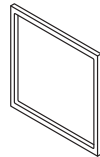

The Waterproof Packing will deteriorate, harden, and shrink depending on the application environment. To ensure maintaining the IP□6 waterproof level, periodically replace the Waterproof Packing. The periodic replacement period will depend on the application environment. You must confirm the proper replacement period. Use one year or less as a guideline. If the Waterproof Packing is not replaced periodically, the waterproof level will not be maintained. It is not necessary to mount the Waterproof Packing if waterproof construction is not required.

Flush Mounting Adapter

Y92F-30

Order the Flush Mounting Adapter separately if it is lost or damaged.

Note: A Flush Mounting Adapter is included with models with screw terminals.

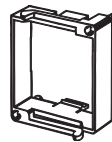

Y92F-38

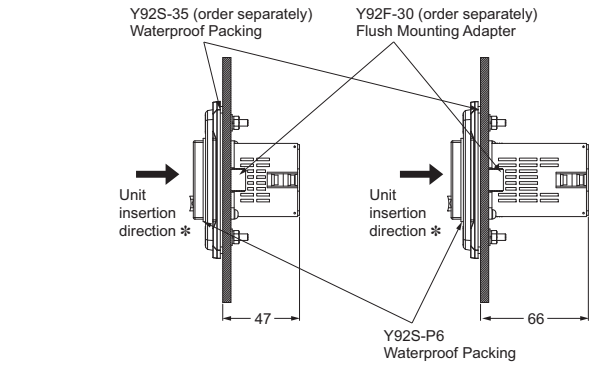
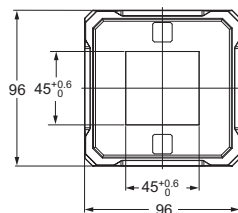

- * Insert the timer unit from front side of adapter.
- * Use Waterproof Packing to provide a level of water protection that complies with IP□6 standards.
- * It is not necessary to mount the Waterproof Packing if waterproof construction is not required.

Waterproof Packing Y92S-35

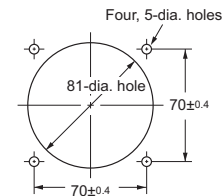

The Y92S-35 is not provided with the Y92F-38. Order separately, if water protection is required. Use Waterproof Packing to provide a level of water protection that complies with IP65 standards. Depending on the operating environment, the Waterproof Packing may deteriorate, contract, or harden and so regular replacement is recommended. The periodic replacement period will depend on the application environment. You must confirm the proper replacement period. Use one year or less as a guideline. If the Waterproof Packing is not replaced periodically, the waterproof level will not be maintained.

Y92F-45

Note: 1. The adapter is black in color.

Note: 2. The Y92F-45 can be used in combination with the Y92F-30 Adapter provided with the Timer.

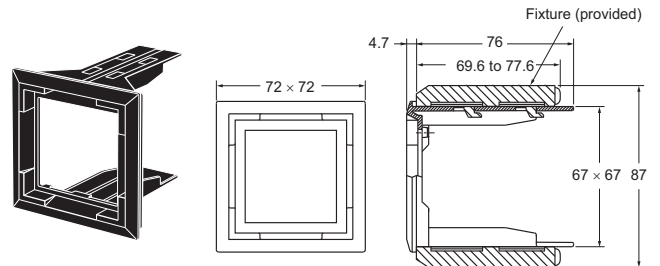

<H5CC Mounting Example>

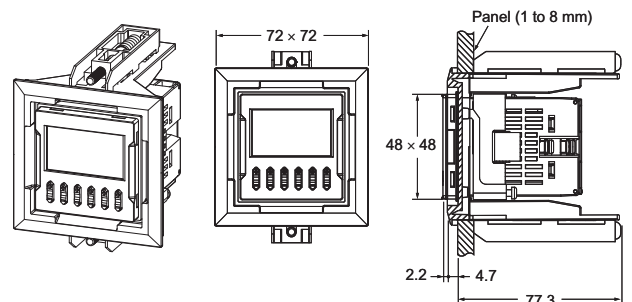

Connection Sockets Front Connecting Sockets

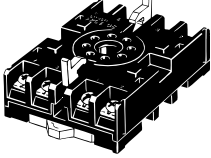
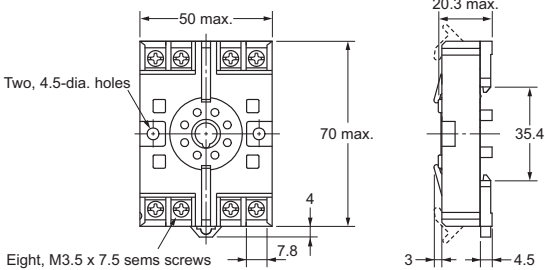
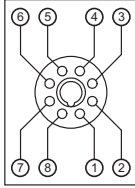
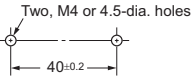
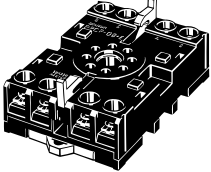
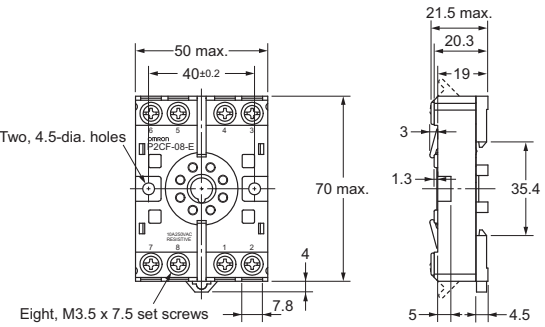
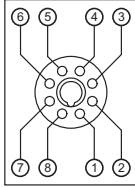
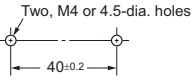
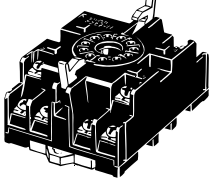
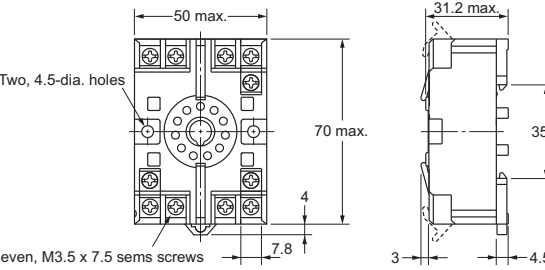
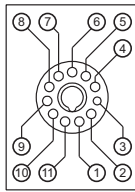
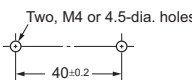
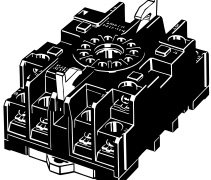
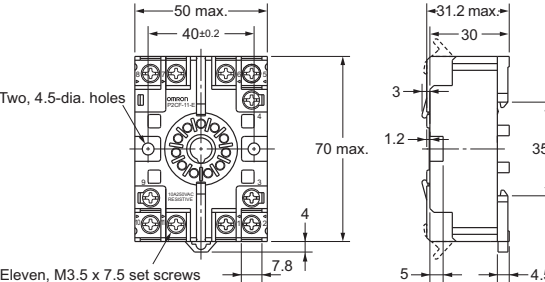
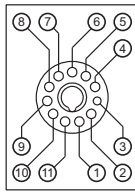
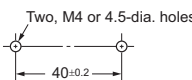
Model	Dimensions	Terminal arrangement and internal connections	Mounting hole dimensions
P2CF-08 			 <p>Note: The Socket can also be mounted to DIN track.</p>
P2CF-08-E (Finger-safe Type) 		 <p>(Top View)</p>	 <p>Note: The Socket can also be mounted to DIN track.</p>
P2CF-11 			 <p>Note: The Socket can also be mounted to DIN track.</p>
P2CF-11-E (Finger-safe Type) 		 <p>(Top View)</p>	 <p>Note: The Socket can also be mounted to DIN track.</p>

Note: Round crimp terminals cannot be used on Finger-safe Sockets. Use forked crimp terminals. The P2CF has hooks to fix the timer so the holding clips are not required.

Back Connecting Sockets

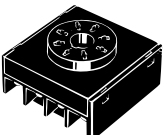
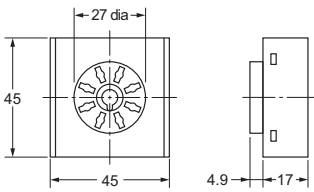
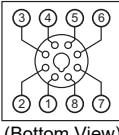
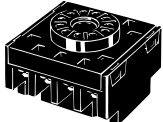
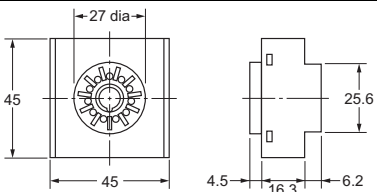
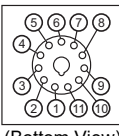
Model	Dimensions	Terminal arrangement and internal connections
P3G-08 		 <p>(Bottom View)</p>
P3GA-11 		 <p>(Bottom View)</p>

Note: A Y92A-48G Terminal Cover can be used with the Socket to enable finger protection.

Terminal Covers for P3G-08 and P3GA-11 Back Connecting Sockets

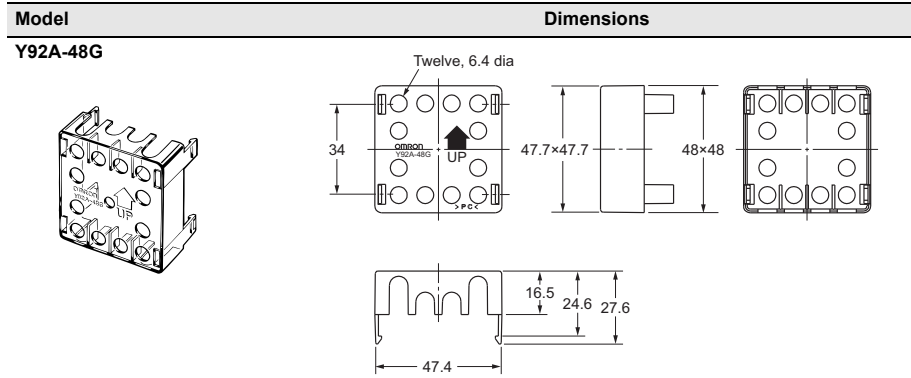

Note: The Terminal Cover can be used with a Back Connecting Socket (P3G-08 or P3GA-11) to enable finger protection.

Optional Products for Track Mounting

Mounting Track

PFP-100N
PFP-50N

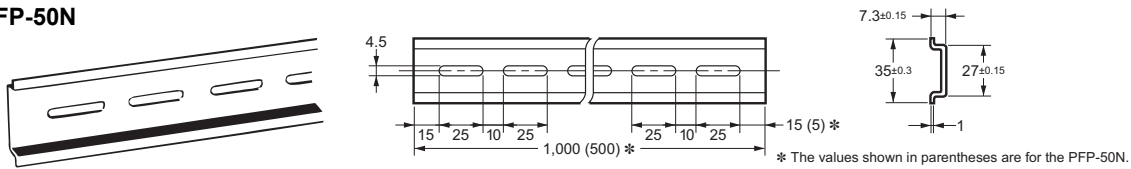

Mounting Track

PFP-100N2

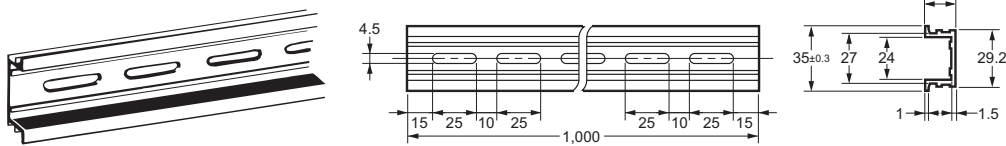

End Plate

PFP-M

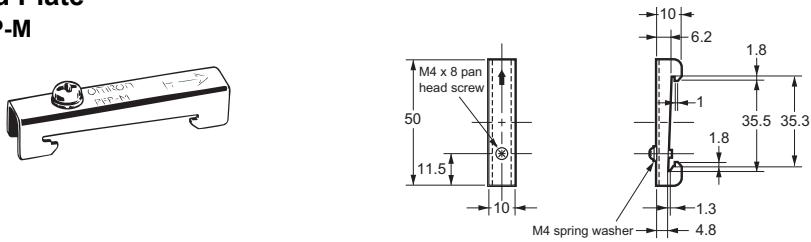

Spacer

PFP-S

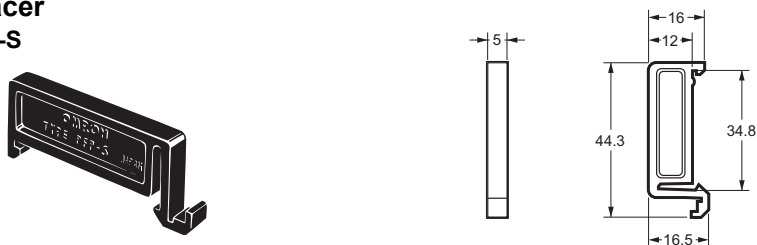

Note: Order Spacers in increments of 10. The above prices are the standard prices for one item.

Operating Procedures of the H5CC-A□/L□

Setting Procedure Guide

Settings for Timer Operation *

Use the following settings.

Settings for Twin Timer Operation *

Refer to page 26.

* "Timer" is set in the default settings. Refer to page 33 for information on switching models.

Step1

Change to Function Setting Mode.

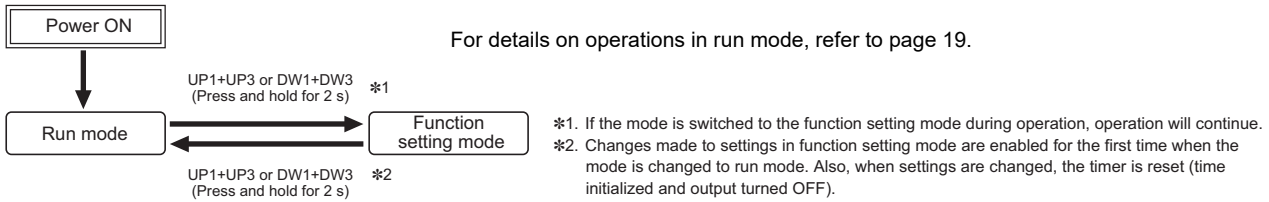

The characters displayed in reverse video are the default settings. In the function setting mode, the status indicators of the keys that can be set light up.

(Example) In the case of the Output time

A value from 0.01 to 99.99 s can be set, and therefore the status indicators of the UP1 to UP4 Keys (DW1 to DW4 Keys) light up.

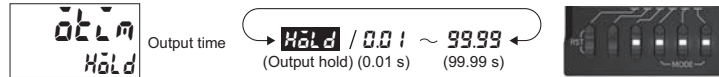

Time Range List

Display	Set Value
-----	0.01 s to 9999.99 s (default setting)
-----.	0.1 s to 99999.9 s
-----.	1 s to 999999 s
-----.	0 h 0 min 01 s to 99 h 59 min 59 s
-----.	0.1 min to 99999.9 min
-----.	1 min to 999999 min
-----.	0 h 01 min to 9999 h 59 min
-----.	0.1 h to 99999.9 h
-----.	1 h to 999999 h
-----.	0.001 s to 999.999 s

* Use UP1+UP3 to move up and DW1+DW3 to move down

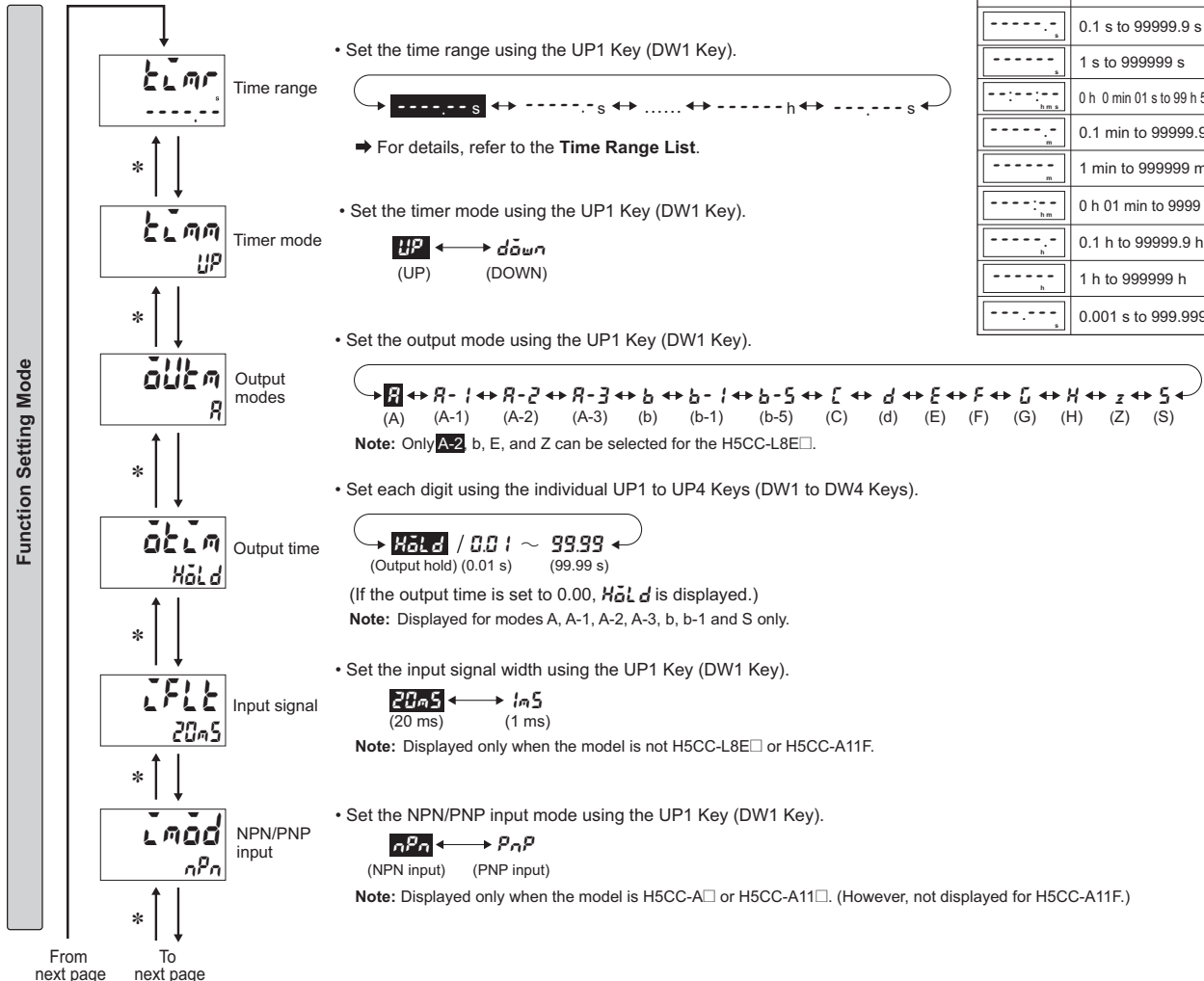

To previous page From previous page

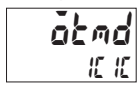

Instantaneous/
time-limit

• Set the function (instantaneous or time-limit operation) for the instantaneous output (output 1) using the UP1 Key (DW1 Key).

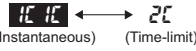

Note: Displayed only when the model is H5CC-L8E□.

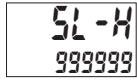

Set value
upper limit

• Set the digits for the set value limit using the corresponding UP1 to UP6 Keys (DW1 to DW6 Keys).

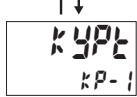

Key protect
level

• Set the key protect level using the UP1 Key (DW1 Key).

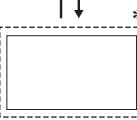
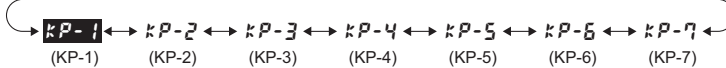

Output
inversion

*1 Set the output inversion using the UP1 Key (DW1 Key).

When the model is not H5CC-L8E□

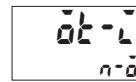

Output
inversion

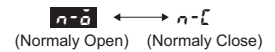

When the model is H5CC-L8E□

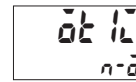

Output 1
(OUT1)
inversion

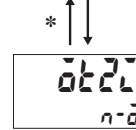
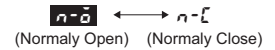

Output 2
(OUT2)
inversion

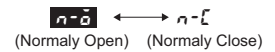

Indicator
display mode

• Set the indicator display mode using the UP1 Key (DW1 Key).



(Count status is turned OFF, and the status indicator is all off.) (Indicator display is turned OFF, and the status indicator is all lit.)

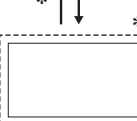

Output ON
count alarm
set value/
monitor value

*2 Set each digit using the individual UP1 to UP4 Keys (DW1 to DW4 Keys).

When the model is not H5CC-L8E□

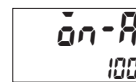

Output ON
count alarm
set value

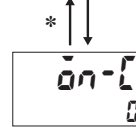

Output ON
count
monitor value

Note: The monitor value is only displayed. It cannot be set.

When the model is H5CC-L8E□



Time-limit
output 1
(OUT1)
ON count
alarm set value



Time-limit
output 2
(OUT2)
ON count
alarm set value

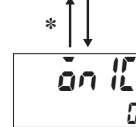

Time-limit
output 1
(OUT1)
ON count
monitor value

Note: The monitor value is only displayed. It cannot be set.

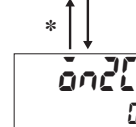

Time-limit
output 2
(OUT2)
ON count
monitor value

Note: The monitor value is only displayed. It cannot be set.

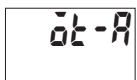

Cumulative
run time
(OT-A)
alarm set value

• Set each digit using the individual UP1 to UP3 Keys (DW1 to DW3 Keys).

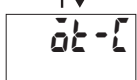

Cumulative
run time
(OT-C)
monitor value

Note: The monitor value is only displayed. It cannot be set.

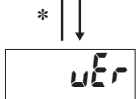

Software
version
(ver.)

Note: The software version is only displayed. It cannot be set.

Explanation of Functions

Operating Procedures for Timer Function

Time Range (t_{min} - t_{max})

Set the range to be timed in the range 0.001 s to 999,999 h.

Timer Mode (t_{min} - t_{max})

Set either the elapsed time (UP) or remaining time (DOWN) mode. In UP mode, the elapsed time is displayed, and in DOWN mode, the remaining time is displayed.

Output Mode (o_{min} - o_{max})

Set the output mode. The possible settings are A, A-1, A-2, A-3, b, b-1, b-5, C, d, E, F, G, H, Z and S. (For details on output mode operation, refer to *Timing Charts* on page 20.)

Output Time (o_{min} - o_{max})

When using one-shot output, set the output time for one-shot output (0.01 to 99.99 s). One-shot output can be used only if the selected output mode is A, A-1, A-2, A-3, b, b-1 or S. If the output time is set to 0.00, *H₀₀ d* is displayed, and the output is held.

Input Signal Width (i_{min} - i_{max})

Set the minimum signal input width (20 ms or 1 ms) for signal, reset, and gate inputs. The same setting is used for all external inputs (signal, reset, and gate inputs). If contacts are used for the input signal, set the input signal width to 20 ms. Processing to eliminate chattering is performed for this setting.

NPN/PNP Input Mode (i_{min} - i_{max})

Select either NPN input (no-voltage input) or PNP input (voltage input) as the input format. Set an NPN input when using a two-wire sensor. The same setting is used for all external inputs. For details on input connections, refer to page 10.

Instantaneous/Time-limit (o_{min} - o_{max})

Set the contact output to time-limit SPDT + instantaneous SPDT or time-limit DPDT operation.

Set Value Upper Limit (S_{min} - S_{max})

Set the upper limit for the set value when it is set in run mode. The limit can be set to between 1 and 999999. This setting does not apply to the ON duty in Z mode.

Key Protect Level (k_{min} - k_{max})

Set the key protect level. Refer to *Key Protect Level* on page 38.

Output inversion (o_{min} - i_{min}, o_{max} - i_{max}, o_{min} - i_{max})

Set logical inversion of output ON/OFF. In the case of two outputs, it is possible to individually set output inversion for each of output 1 and output 2 (OUT1 and OUT2). If output inversion is *o_{min} - o_{max}* (Normally Open), the output turns ON when the set value is reached. If output inversion is *o_{min} - i_{max}* (Normally close), the output turns OFF when the set value is reached.

Indicator Display Mode (i_{min} - i_{max})

Settings can be made to display the present value in status indicator. When this mode is ON, the status indicator changes in accordance with the ratio of the present value to the set value. In the case of ALOF, the indicator display is turned OFF, and the status indicator is all off. In the case of ALLT, the indicator display is turned OFF, and the status indicator is all lit.

(Example 1) When incrementing input is performed

The status indicators light up in an order starting from the left, when the status reaches 1/6, 2/6, 3/6 (50%), 4/6, 5/6, 6/6 (100%) in accordance with the ratio of the present value to the set value. Three indicators on the left light up when the status reaches 50%, and all indicators light up when the status reaches 100%. All indicators are lit even when the status is 100% or more. All indicators turn off when the value changes from 999999 to 0. If the timer continues thereafter, the status indicator will light up according to the present value.

(Example 2) When decrementing input is performed

The status indicators turn off in an order starting from the right, when the status reaches 5/6, 4/6, 3/6 (50%), 2/6, 1/6, 0 in accordance with the ratio of the present value to the set value. Three indicators on the right turn off when the status reaches 50%, and all indicators turn off when the status reaches 0.

Output ON Count Alarm Set Value (o_{min} - R_{min}, o_{max} - R_{max}, o_{min} - R_{max})

Set the alarm value for the output ON count. The limit can be set between 0 × 1000 (0 times) and 9999 × 1000 (9,999,000 times). Only the underlined values are set. The alarm will be disabled if 0 is set. 100,000 times is set in the default settings. If the total output ON count reaches the alarm set value or above, an RPLC (replacement time) error can be displayed on the Timer. For details, refer to page 37.

Output ON Count Monitor Value (o_{min} - L_{min})

The monitor value is only displayed. It cannot be set. The output ON count will be 1,000 times the displayed value.

ON Count Monitor Values for Outputs 1 and 2 (OUT1 and OUT2) (o_{min} - L_{min} and o_{max} - L_{max})

The monitor value for output 1 and 2 (OUT1 and OUT2) is only displayed. It cannot be set. The output ON count will be 1,000 times the displayed value.

Cumulative Run Time Alarm Set Value (o_{min} - R_{min})

The cumulative run time for notifying the replacement time can be set. For details, refer to page 37.

Cumulative Run Time Monitor (o_{min} - L_{min})

The cumulative run time is displayed. It is not a setting item. The numerical values are displayed in increments of 0.1 years.

Operation in Run Mode

Operating Procedures for Timer Function

Present value

Set value

- Set each digit for the output time using the corresponding UP1 to UP6 Keys (DW1 to DW6 Keys).

Note: H5CC-L8E□ Precautions
Set the Timer's set value before using the Timer in a self-holding circuit.

▪ When Output Mode Z Is Selected

Present value

ON duty ratio

- Set each digit for the output time using the corresponding UP1 to UP3 Keys (DW1 to DW3 Keys). (The UP4 to UP6 Keys (DW4 to DW6 Keys) cannot be used.)

* ↑ ↓

Present value

Cycle time

- Set each digit for the output time using the corresponding UP1 to UP6 Keys (DW1 to DW6 Keys).

Note. Each time the UP1 + UP3 or DW1 + DW3 are pressed, the sub-display will switch between ON duty ratio ("SET1" is lit) and cycle time ("SET2" is lit).

Present Value and Set Value

These items are displayed when the power is turned ON. The present value is displayed in the main display and the set value is displayed in the sub-display.

The values displayed will be determined by the settings made for the time range and the timer mode in function setting mode.

Present Value and ON Duty Ratio (Output Mode = Z)

The present value is displayed in the main display and the ON duty ratio is displayed in the sub-display. Set the ON duty ratio used in ON/OFF-duty-adjustable flicker mode (Z) as a percentage.

$$\text{ON time} = \text{Cycle time} \times \frac{\text{ON duty ratio (\%)}}{100}$$

- The output accuracy will vary with the time range, even if the ON duty ratio setting is the same. Therefore, if fine output time adjustment is required, it is recommended that the time range for the cycle time is set as small as possible.

Examples:

1. When Time Range = - - - - s (9999 s)

$$20(\text{s}) \times \frac{31(\%)}{100} = 6.2(\text{s})$$

Rounded off to the nearest integer (because of the time range setting) → ON time = 6 s

2. When Time Range = - - . - s (99.99 s)

$$20.00(\text{s}) \times \frac{31(\%)}{100} = 6.200(\text{s})$$

Rounded off to 2 decimal places (because of the time range setting) → ON time = 6.20 s

If a cycle time is set, cyclic control can be performed in ON/OFF-duty-adjustable flicker mode simply by changing the ON duty ratio.

Present Value and Cycle Time (Output Mode = Z)

The present value is displayed in the main display and the cycle time is displayed in the sub-display.

Set the cycle time.

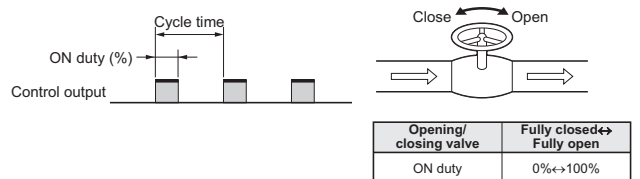
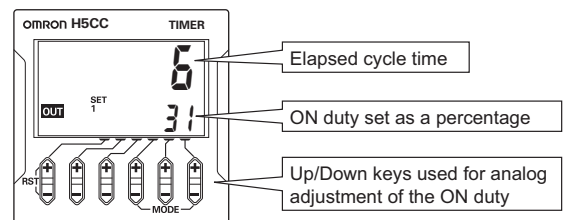

Timing Charts

Operating Procedures for Timer Function

Models Other than the H5CC-L8E□

The gate input is not included in the H5CC-L8□ models.

 Either one-shot output or sustained output can be selected.

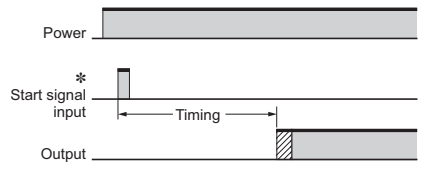
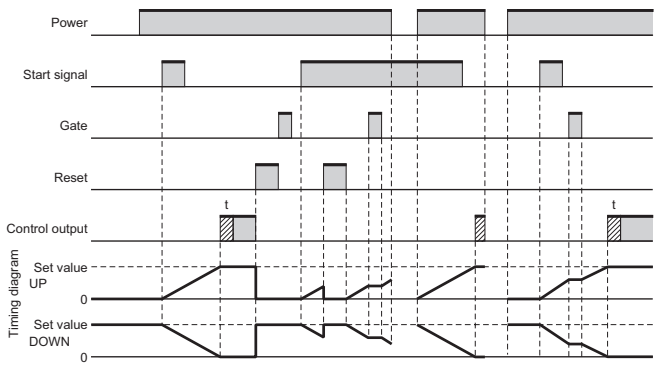
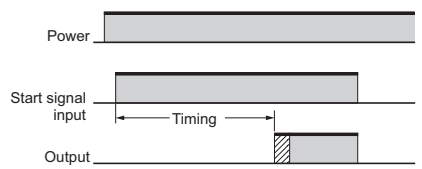
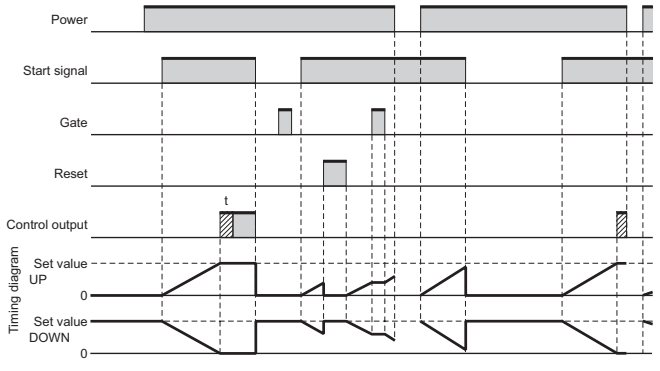
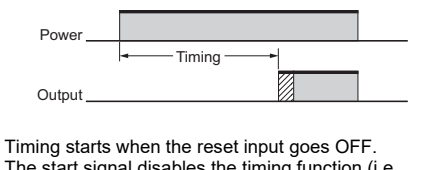
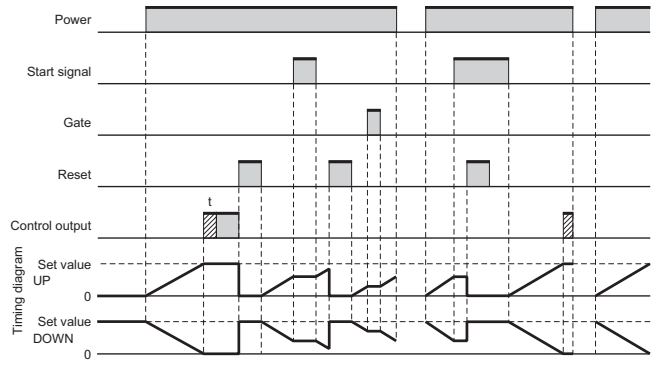
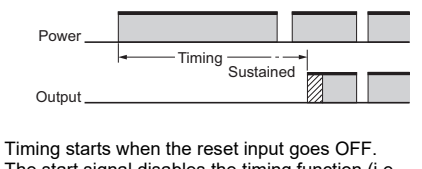
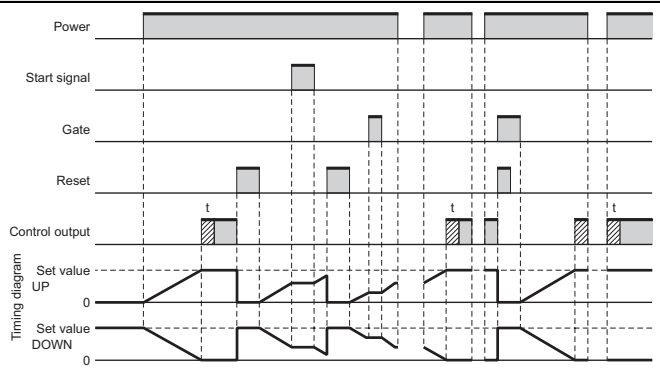
Mode A: Signal ON delay I (Timer resets when power comes ON.)	
Basic operation	Detailed operation
 <p>* Start signal input is disabled during timing.</p> <p>Timing starts when the start signal goes ON. While the start signal is ON, the timer starts when the power comes ON or when the reset input goes OFF. The control output is controlled using a sustained or one-shot time period.</p> <p>Note: Output is instantaneous when setting is 0.</p>	
Mode A-1: Signal ON delay II (Timer resets when power comes ON.)	
Basic operation	Detailed operation
 <p>Timing starts when the start signal goes ON, and resets when the start signal goes OFF. While the start signal is ON, the timer starts when the power comes ON or when the reset input goes OFF. The control output is controlled using a sustained or one-shot time period.</p> <p>Note: Output is instantaneous when setting is 0.</p>	
Mode A-2: Power ON delay I (Timer resets when power comes ON.)	
Basic operation	Detailed operation
 <p>Timing starts when the reset input goes OFF. The start signal disables the timing function (i.e., same function as the gate input). The control output is controlled using a sustained or one-shot time period.</p> <p>Note: Output is instantaneous when setting is 0.</p>	
Mode A-3: Power ON delay II (Timer does not reset when power comes ON.)	
Basic operation	Detailed operation
 <p>Timing starts when the reset input goes OFF. The start signal disables the timing function (i.e., same function as the gate input). The control output is controlled using a sustained or one-shot time period.</p> <p>Note: Output is instantaneous when setting is 0.</p>	

Mode b: Flicker I (Timer resets when power comes ON.)

Basic operation

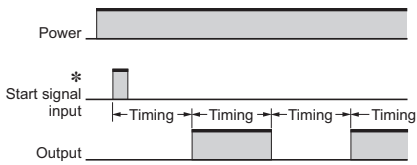

* Start signal input is disabled during timing.

Timing starts when the start signal goes ON.
The status of the control output is reversed when time is up (OFF at start).

While the start signal is ON, the timer starts when the power comes ON or when the reset input goes OFF.

Note: Normal output operation will not be possible if the set time is too short.
Set the value to at least 100 ms (contact output type).

Detailed operation

Sustained Output

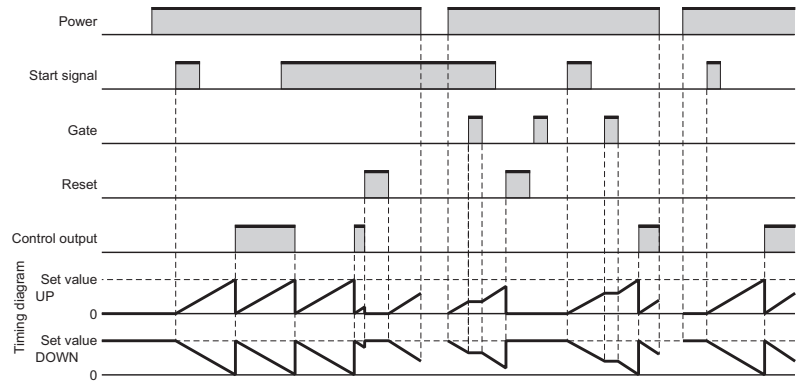

One-shot Output

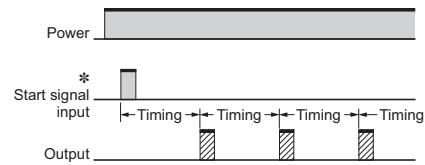
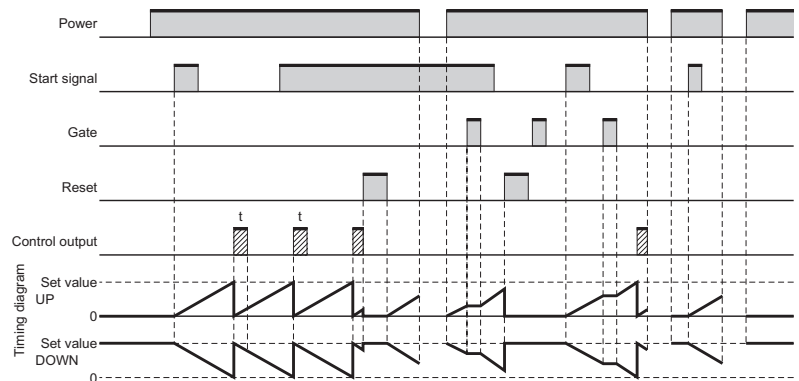

* Start signal input is disabled during timing.

Timing starts when the start signal goes ON.
The control output is turned ON when time is up.

While the start signal is ON, the timer starts when the power comes ON or when the reset input goes OFF.

Note: Normal output operation will not be possible if the set time is too short.
Set the value to at least 100 ms (contact output type).

Mode b-1: Flicker II (Timer does not reset when power comes ON.)

Basic operation

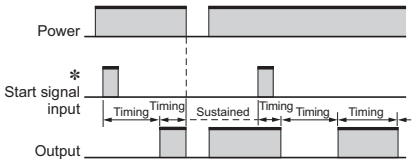

* Start signal input is disabled during timing.

Timing starts when the start signal goes ON.
The status of the control output is reversed when time is up (OFF at start).

While the start signal is ON, the timer starts when the power comes ON or when the reset input goes OFF.

Note: Normal output operation will not be possible if the set time is too short.
Set the value to at least 100 ms (contact output type).

Detailed operation

Sustained Output

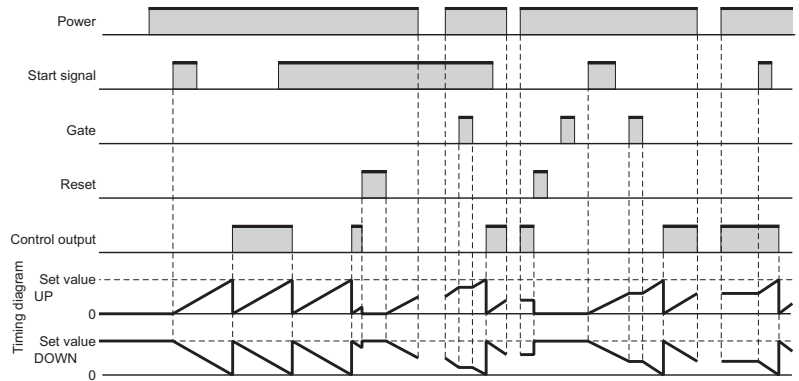

One-shot Output

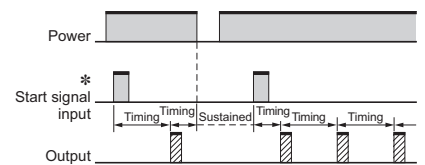
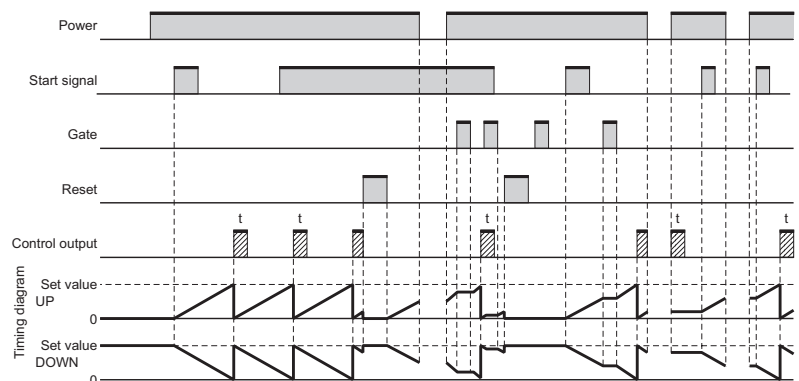

* Start signal input is disabled during timing.

Timing starts when the start signal goes ON.
The control output is turned ON when time is up.

While the start signal is ON, the timer starts when the power comes ON or when the reset input goes OFF.

Note: Normal output operation will not be possible if the set time is too short.
Set the value to at least 100 ms (contact output type).

H5CC

Timer

Mode b-5: One-shot flicker (Timer resets when power comes ON.)

Basic operation

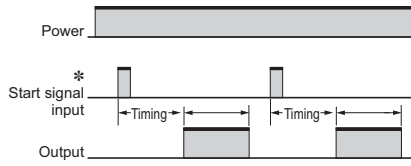

* Start signal input is disabled during timing.

Timing starts when the start signal goes ON. The control output is turned ON when time is up. It resets in one cycle.

While the start signal is ON, the timer starts when the power comes ON or when the reset input goes OFF.

Note: Normal output operation will not be possible if the set time is too short. Set the value to at least 100 ms (contact output type).

Detailed operation

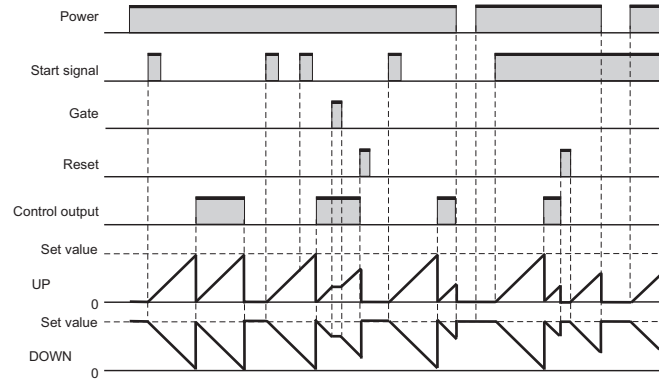

Mode C: Signal ON/OFF delay I (Timer resets when power comes ON.)

Basic operation

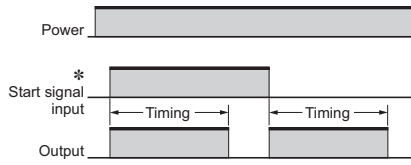

* Start signal input is enabled during timing.

While the start signal is ON, the timer starts when the power comes ON or when the reset input goes OFF. The timer resets when the time is up.

Note: Output is disabled when the setting is 0.

Detailed operation

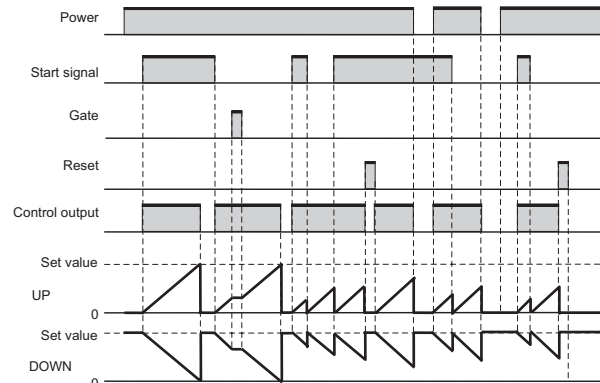

Mode d: Signal OFF delay I (Timer resets when power comes ON.)

Basic operation

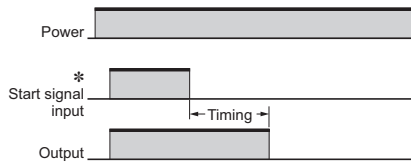

* Start signal input is enabled during timing.

The control output is ON when the start signal is ON (except when the power is OFF or the reset is ON). The timer resets when the time is up.

Note: Output functions only during start signal input when setting is 0.

Detailed operation

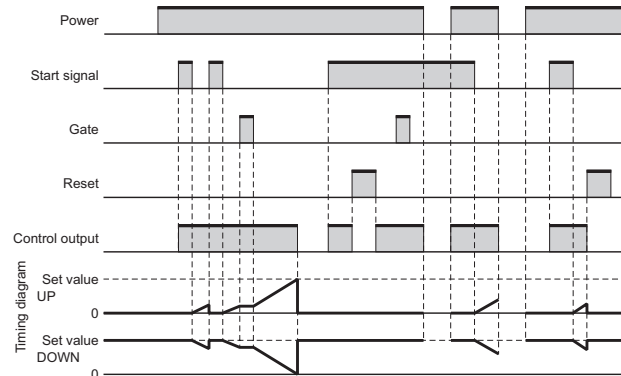

Mode E: Interval (Timer resets when power comes ON.)

Basic operation

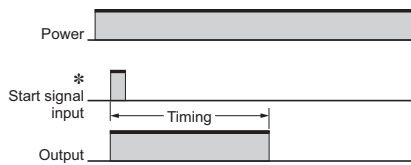

* Start signal input is enabled during timing.

Timing starts when the start signal comes ON. The timer resets when the time is up.

While the start signal is ON, the timer starts when the power comes ON or when the reset input goes OFF.

Note: Output is disabled when the setting is 0.

Detailed operation

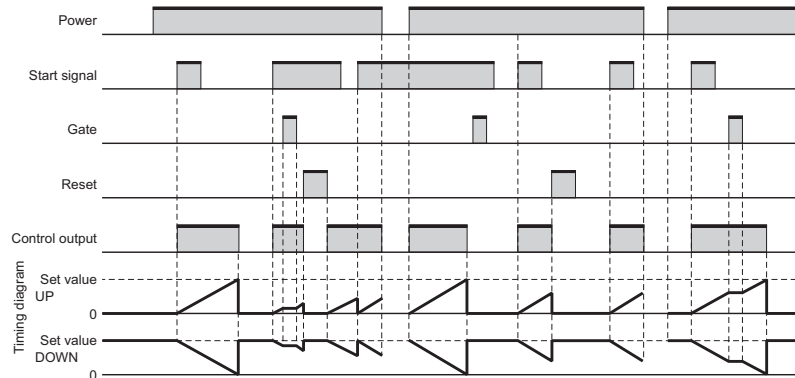

Mode F: Cumulative (Timer does not reset when power comes ON.)

Basic operation

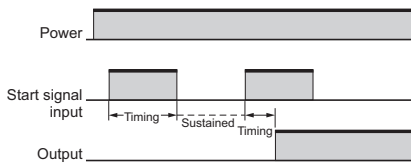

Start signal enables timing (timing is stopped when the start signal is OFF or when the power is OFF). A sustained control output is used.

Note: Output is instantaneous when setting is 0. When the H5CC is used with power-ON start, there will be a timer error (approximately 100 ms each time the H5CC is turned ON) due to the characteristics of the internal circuit. Use the H5CC with signal start if timer accuracy is required.

Detailed operation

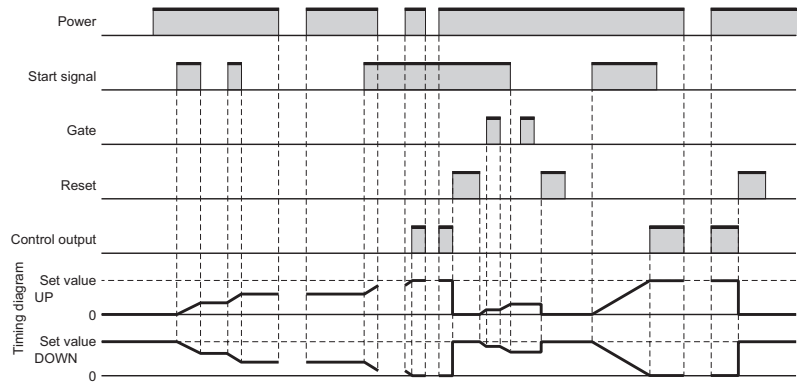

Mode G: Signal ON/OFF delay II (Timer resets when power comes ON.)

Basic operation

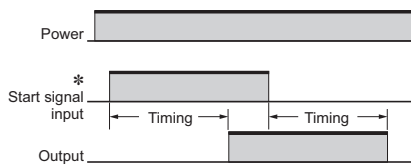

* Start signal input is enabled during timing.

While the start signal is ON, the timer starts when the power comes ON or when the reset input goes OFF. The timer resets when the time is up.

Note: Output functions only during start signal input when setting is 0.

Detailed operation

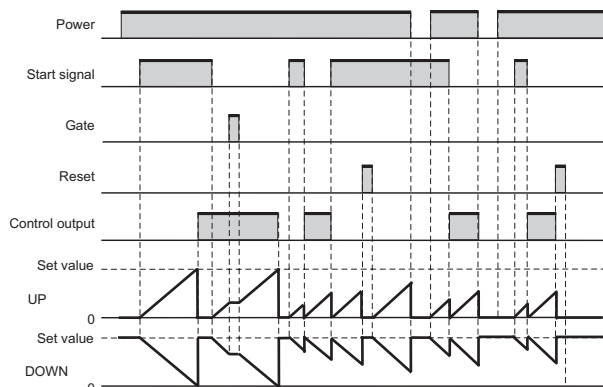

Mode H: Signal OFF delay II (Timer resets when power comes ON.)

Basic operation

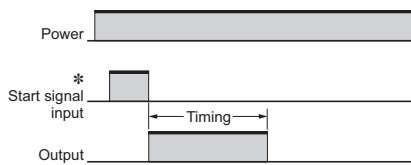

* Start signal input is enabled during timing.

The control output is OFF when the start signal is ON. The timer resets when the time is up.

Note: Output is disabled when the setting is 0.

Detailed operation

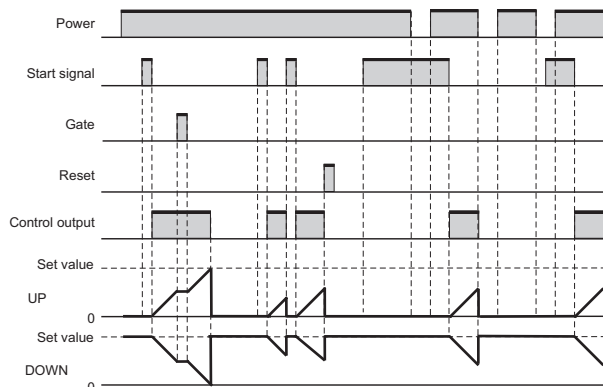

Mode Z: ON/OFF-duty-adjustable flicker (Timer resets when power comes ON.)

Basic operation

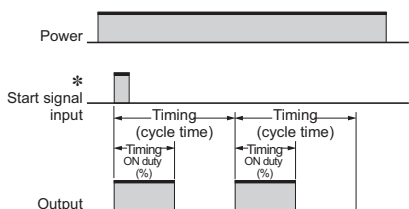

* Start signal input is disabled during timing.

Timing starts when the start signal goes ON. The status of the control output is reversed when time is up (ON at start).

While the start signal is ON, the timer starts when the power comes ON or when the reset input goes OFF.

Note: Normal output operation will not be possible if the set time is too short. Set the value to at least 100 ms (contact output type).

Detailed operation

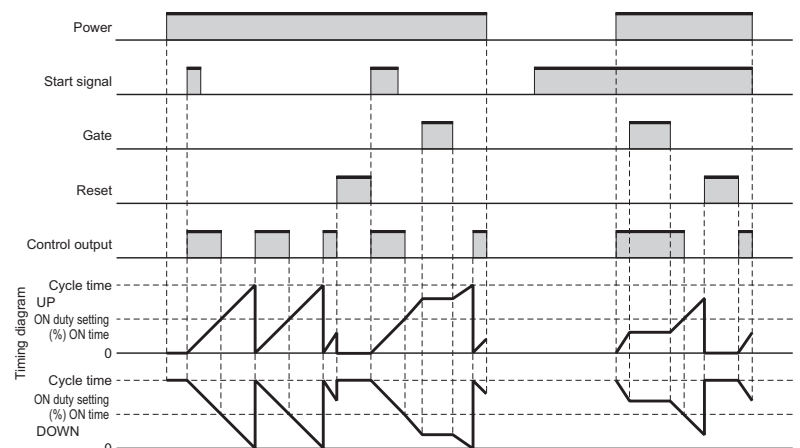

H5CC

Timer

Mode S: Stopwatch (Timer resets when power comes ON.)

Basic operation

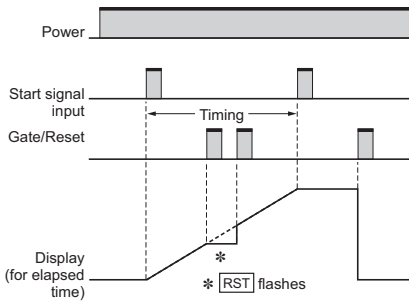

The signal starts and stops timing.
The display is held and timing is continued if the reset or gate input is received during timing operation.
The timer resets if the reset or gate input is received when the timing operation is stopped.

Note: Output is instantaneous when setting is 0.

Detailed operation

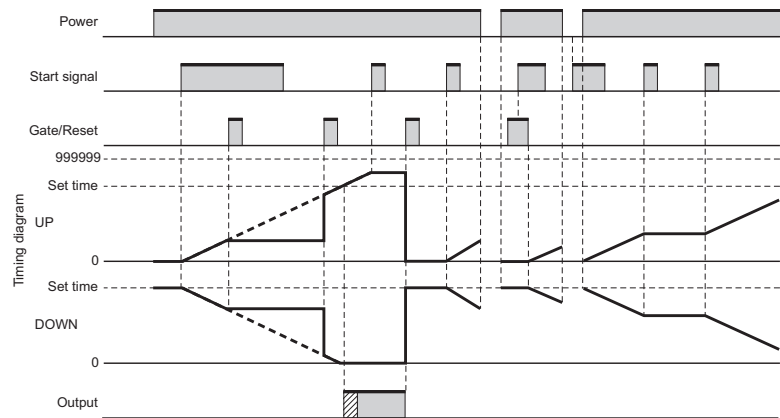

H5CC-L8E□

Either one-shot output or sustained output can be selected.

Mode A-2: Power ON delay (Timer resets when power comes ON.)

Basic operation

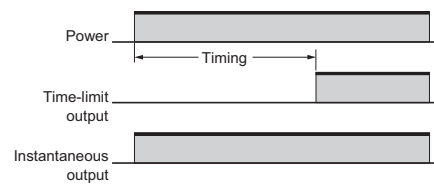

The Timer starts when the power comes ON or when the reset input goes OFF.

Note: Output is instantaneous when setting is 0.

Detailed operation

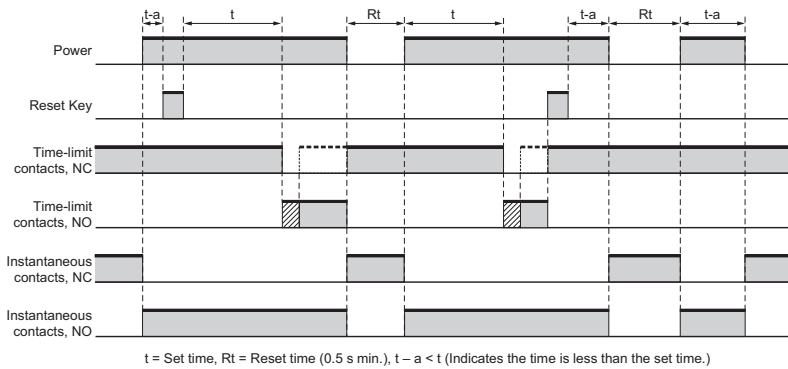

Mode b: Flicker I (Timer resets when power comes ON.)

Basic operation

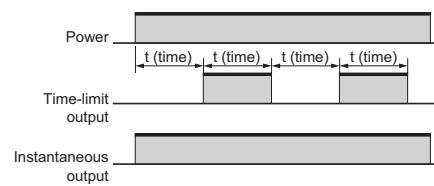

The Timer starts when the power comes ON or when the reset input goes OFF.

Note: Normal output operation will not be possible if the set time is too short.
Set the value to at least 100 ms.

Detailed operation

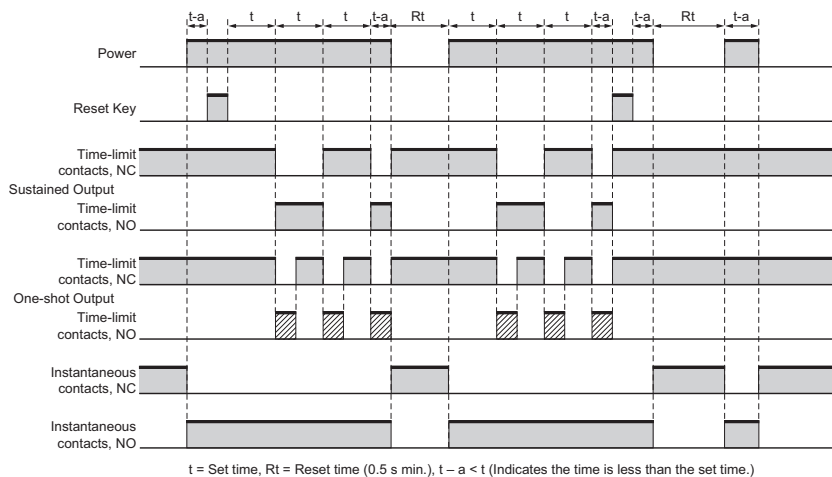

Note: H5CC-L8E□ Precautions

Set the Timer's set value before using the Timer in a self-holding circuit.

Mode E: Interval (Timer resets when power comes ON.)

Basic operation

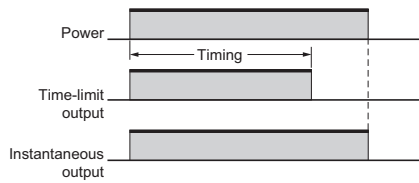

The Timer starts when the power comes ON or when the reset input goes OFF.

Note: Output is not instantaneous when setting is 0.

Detailed operation

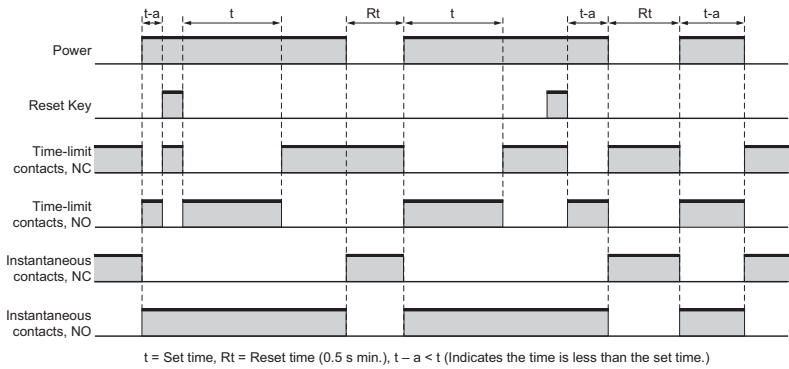

Mode Z: ON/OFF-duty-adjustable flicker (Timer resets when power comes ON.)

Basic operation

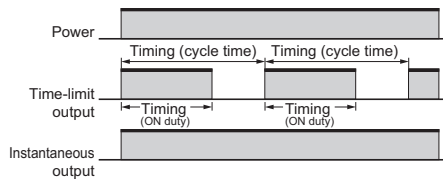

The Timer starts when the power comes ON or when the reset input goes OFF.

Note: Normal output operation will not be possible if the set time is too short. Set the value to at least 100 ms.

Detailed operation

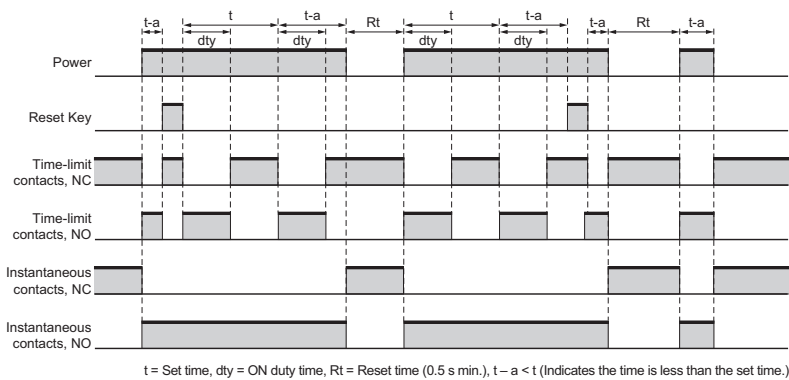

Note: H5CC-L8E□ Precautions

Set the Timer's set value before using the Timer in a self-holding circuit.

Setting Procedure Guide

Operating Procedures for Twin Timer Function

Step1 Switching to a Twin Timer

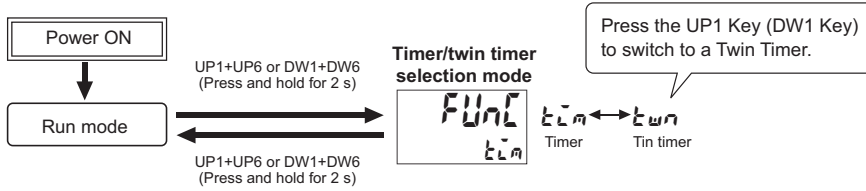

Step2

Change to Function Setting Mode.

For details on operations in run mode, refer to page 30.

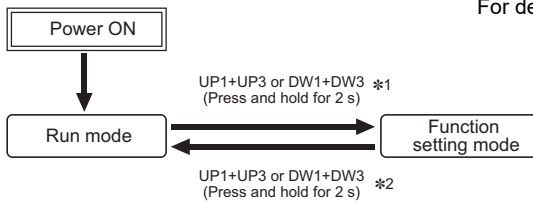

- *1. If the mode is switched to the function setting mode during operation, operation will continue.
- *2. Changes made to settings in function setting mode are enabled for the first time when the mode is changed to run mode. Also, when settings are changed, the timer is reset (time initialized and output turned OFF).

The characters displayed in reverse video are the default settings. In the function setting mode, the status indicators of the keys that can be set light up.

(Example) In the case of the set value upper limit 1

A value from 1 to 999999 can be set, and therefore the status indicators of the UP1 to UP6 Keys (DW1 to DW6 Keys) light up.

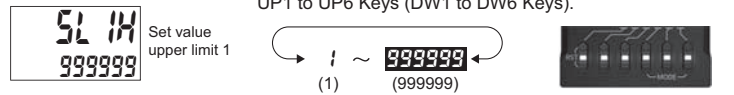

* Use UP1+UP3 to move up and DW1+DW3 to move down

Time Range List

Display	Set Value
-----s	0.01 s to 9999.99 s (default setting)
-----.s	0.1 s to 99999.9 s
-----s	1 s to 999999 s
-----h m s	0 h 0 min 01 s to 99 h 59 min 59 s
-----m	0.1 min to 99999.9 min
-----m	1 min to 999999 min
-----h m	0 h 01 min to 9999 h 59 min
-----h	0.1 h to 99999.9 h
-----h	1 h to 999999 h
-----s	0.001 s to 999.999 s

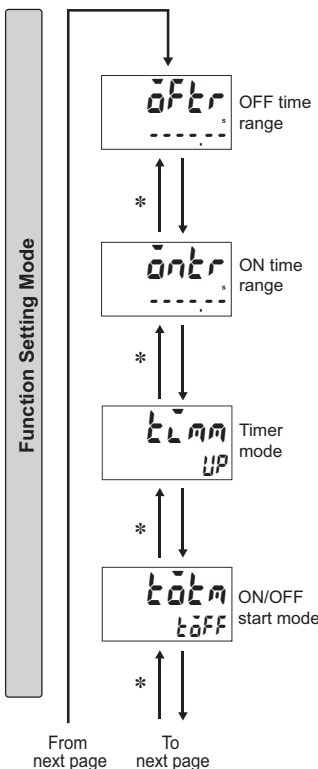

• Set the OFF time range using the UP1 Key (DW1 Key).



• Set the ON time range using the UP1 Key (DW1 Key).



• Set the timer mode using the UP1 Key (DW1 Key).

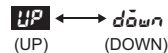

• Set the twin timer output mode using the UP1 Key (DW1 Key).

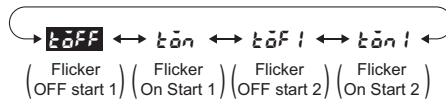

Note: Only Flicker OFF Start 1 or Flicker ON Start 1 can be selected for the H5CC-L8E□.

Function Setting Mode

To previous page

From previous page

Input signal width

 20ms

• Set the input signal width using the UP1 Key (DW1 Key).

20ms ↔ 1ms
 (20 ms) (1 ms)

Note: Displayed only when the model is not H5CC-L8E□ or H5CC-A11F.

NPN/PNP input

 NPN

• Set the NPN/PNP input mode using the UP1 Key (DW1 Key).

NPN ↔ PNP
 (NPN input) (PNP input)

Note: Displayed only when the model is H5CC-A□ or H5CC-A11□. (However, not displayed for H5CC-A11F.)

Instantaneous/
time-limit

 IL IL

• Set the function (instantaneous or time-limit operation) for the instantaneous output (out 1) using the UP1 Key (DW1 Key).

IL IL ↔ 2L
 (Instantaneous) (Time-limit)

Note: Displayed only when the model is H5CC-L8E□.

Set value upper limit 1

 5L 14
 999999

• Set the digits for the set value limit using the corresponding UP1 to UP6 Keys (DW1 to DW6 Keys).

1 ~ 999999
 (1) (999999)

Set value upper limit 2

 5L 24
 999999

• Set the digits for the set value limit using the corresponding UP1 to UP6 Keys (DW1 to DW6 Keys).

1 ~ 999999
 (1) (999999)

Key protect level

 KP-1

• Set the key protect level using the UP1 Key (DW1 Key).

KP-1 ↔ KP-2 ↔ KP-3 ↔ KP-4 ↔ KP-5 ↔ KP-6 ↔ KP-7
 (KP-1) (KP-2) (KP-3) (KP-4) (KP-5) (KP-6) (KP-7)

Output inversion

 n-o

*1 Set the output inversion using the UP1 Key (DW1 Key).

When the model is not H5CC-L8E□

n-o ↔ n-c
 (Normally Open) (Normally Close)

When the model is H5CC-L8E□

Output 1 (OUT1) inversion

 n-o ↔ n-c
 (Normally Open) (Normally Close)

Output 2 (OUT2) inversion

 n-o ↔ n-c
 (Normally Open) (Normally Close)

From next page

To next page

• Set the indicator display mode using the UP1 Key (DW1 Key).

o-n ↔ AL OF ↔ ALL L
 (Count status (Indicator display is turned OFF, and the status indicator is all off.) (Indicator display is turned OFF, and the status indicator is all lit.)

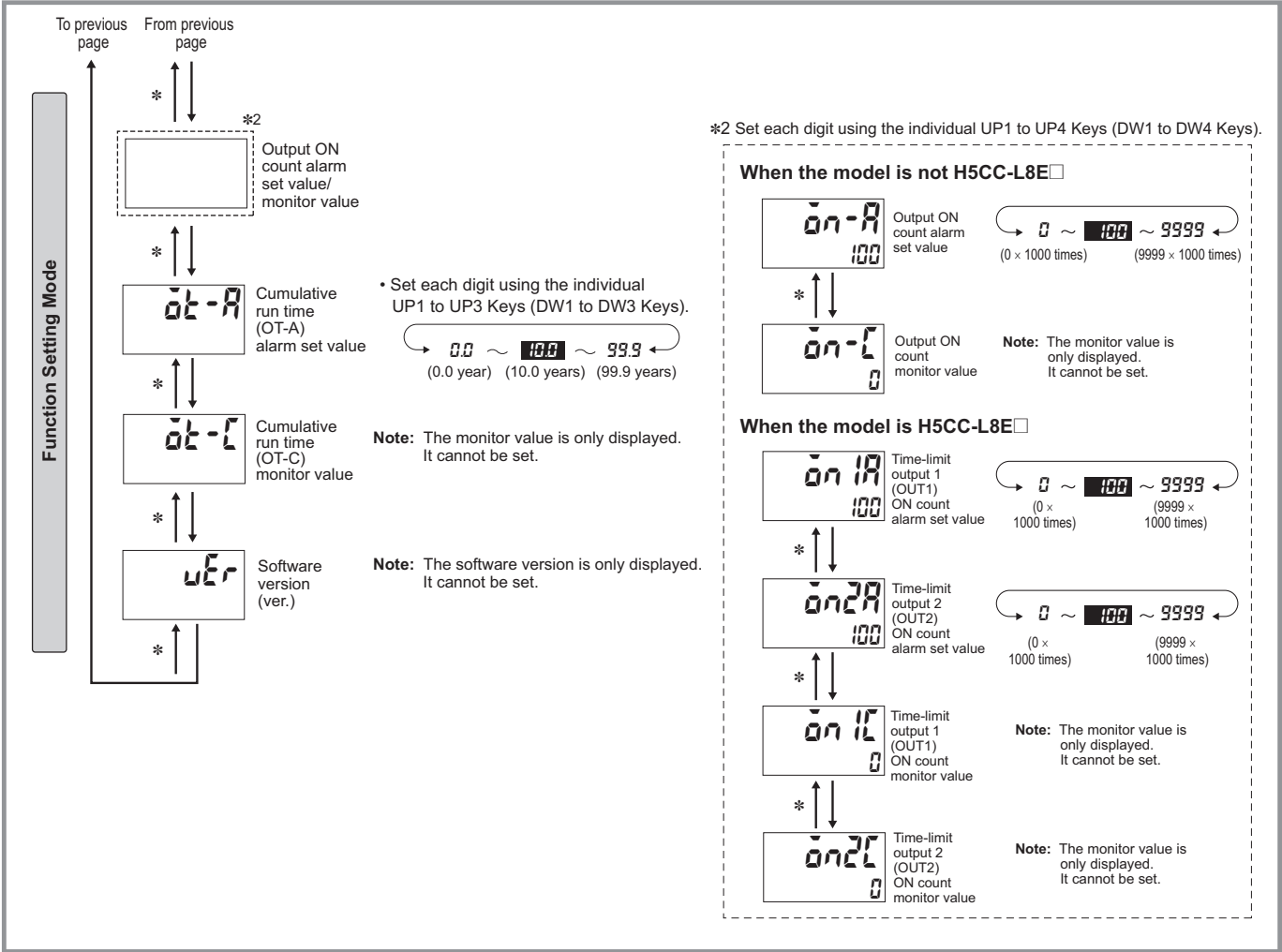

Explanation of Functions

Operating Procedures for Twin Timer Function

OFF Time Range ($\bar{\alpha}F\bar{t}r$)

Set the time range for the OFF time in the range 0.001 s to 999,999 h.

ON Time Range ($\bar{\alpha}n\bar{t}r$)

Set the time range for the ON time in the range 0.001 s to 999,999 h.

Timer Mode ($\bar{t}\bar{m}m$)

Set either the elapsed time (UP) or remaining time (DOWN) mode. In UP mode, the elapsed time is displayed, and in DOWN mode, the remaining time is displayed.

ON/OFF Start Mode ($\bar{t}\bar{\alpha}\bar{t}m$)

Set the output mode.
Set either flicker OFF start or flicker ON start.
(For details on output mode operation, refer to *Timing Charts* on page 31.)

Input Signal Width ($\bar{t}F\bar{t}\bar{t}$)

Set the minimum signal input width (20 ms or 1 ms) for signal, reset, and gate inputs.

The same setting is used for all external inputs (signal, reset, and gate inputs).

If contacts are used for the input signal, set the input signal width to 20 ms.

Processing to eliminate chattering is performed for this setting.

NPN/PNP Input Mode ($\bar{t}n\bar{\alpha}d$)

Select either NPN input (no-voltage input) or PNP input (voltage input) as the input format.

Set an NPN input when using a two-wire sensor. The same setting is used for all external inputs.

For details on input connections, refer to page 10.

Instantaneous/Time-limit ($\bar{\alpha}\bar{t}m\bar{d}$)

Set the contact output to time-limit SPDT + instantaneous SPDT or time-limit DPDT operation.

Set Value Upper Limit 1, 2 ($\bar{S}\bar{L}\bar{1}\bar{H}$ and $\bar{S}\bar{L}\bar{2}\bar{H}$)

Set the upper limit for the set value when it is set in run mode. The limit can be set to between 1 and 999999.

Key Protect Level ($\bar{k}\bar{y}\bar{P}\bar{L}$)

Set the key protect level.
Refer to *Key Protect Level* on page 38.

Output inversion ($\bar{\alpha}\bar{t}\bar{-}\bar{t}$, $\bar{\alpha}\bar{t}\bar{1}\bar{-}$, $\bar{\alpha}\bar{t}\bar{2}\bar{-}$)

Set logical inversion of output ON/OFF. In the case of two outputs, it is possible to individually set output inversion for each of output 1 and output 2 (OUT1 and OUT2). If output inversion is $n\bar{\alpha}$ (Normally Open), the output turns ON when the set value is reached. If output inversion is $n\bar{t}$ (Normally close), the output turns OFF when the set value is reached.

Indicator Display Mode ($\bar{t}n\bar{d}\bar{t}$)

Settings can be made to display the present value in status indicator. When this mode is ON, the status indicator changes in accordance with the ratio of the present value to the set value. In the case of ALOF, the indicator display is turned OFF, and the status indicator is all off. In the case of ALLT, the indicator display is turned OFF, and the status indicator is all lit.

(Example 1) When incrementing input is performed
The status indicators light up in an order starting from the left, when the status reaches 1/6, 2/6, 3/6 (50%), 4/6, 5/6, 6/6 (100%) in accordance with the ratio of the present value to the set value. Three indicators on the left light up when the status reaches 50%, and all indicators light up when the status reaches 100%. All indicators are lit even when the status is 100% or more. All indicators turn off when the value changes from 999999 to 0. If the timer continues thereafter, the status indicator will light up according to the present value.

(Example 2) When decrementing input is performed
The status indicators turn off in an order starting from the right, when the status reaches 5/6, 4/6, 3/6 (50%), 2/6, 1/6, 0 in accordance with the ratio of the present value to the set value. Three indicators on the right turn off when the status reaches 50%, and all indicators turn off when the status reaches 0.

Output ON Count Alarm Set Value ($\bar{\alpha}n\bar{-}R$, $\bar{\alpha}n\bar{1}R$, $\bar{\alpha}n\bar{2}R$)

Set the alarm value for the output ON count.
The limit can be set between $\underline{0}\times 1000$ (0 times) and $\underline{9999}\times 1000$ (9,999,000 times). Only the underlined values are set. The alarm will be disabled if 0 is set.

100,000 times is set in the default settings.

If the total output ON count reaches the alarm set value or above, an RPLC (replacement time) error can be displayed on the Timer. For details, refer to page 37.

Output ON Count Monitor Value ($\bar{\alpha}n\bar{-}L$)

The monitor value is only displayed. It cannot be set.
The output ON count will be 1,000 times the displayed value.

ON Count Monitor Values for Outputs 1 and 2 (OUT1 and OUT2) ($\bar{\alpha}n\bar{1}L$ and $\bar{\alpha}n\bar{2}L$)

The monitor value for output 1 and 2 (OUT1 and OUT2) is only displayed. It cannot be set.
The output ON count will be 1,000 times the displayed value.

Cumulative Run Time Alarm Set Value ($\bar{\alpha}\bar{t}\bar{-}R$)

The cumulative run time for notifying the replacement time can be set. For details, refer to page 37.

Cumulative Run Time Monitor ($\bar{\alpha}\bar{t}\bar{-}L$)

The cumulative run time is displayed. It is not a setting item. The numerical values are displayed in increments of 0.1 years.

Operation in Run Mode

Operating Procedures for Twin Timer Function

Present value
 OFF set time

*

Present value
 ON set time

▪ Set the digits for the OFF set time using the corresponding UP1 to UP6 Keys (DW1 to DW6 Keys).
 0 ↔ 1 ↔ 2 ↔ 3 ↔ 4 ↔ 5 ↔ 6 ↔ 7 ↔ 8 ↔ 9

▪ Set the digits for the ON set time using the corresponding UP1 to UP6 Keys (DW1 to DW6 Keys).
 0 ↔ 1 ↔ 2 ↔ 3 ↔ 4 ↔ 5 ↔ 6 ↔ 7 ↔ 8 ↔ 9

Note: 1. The display will automatically show the OFF set time when the OFF time is being timed and the ON set time when the ON time is being timed.
Note: 2. H5CC-L8E□ Precautions
 Set the Timer's set value before using the Timer in a self-holding circuit.

Present Value and OFF Set Time

The present value is displayed in the main display and the OFF set time is displayed in the sub-display.
Set the OFF time.

Present Value and ON Set Time

The present value is displayed in the main display and the ON set time is displayed in the sub-display.
Set the ON time.

Timing Charts

Operating Procedures for Twin Timer Function

Models Other than the H5CC-L8E□

The gate input is not included in the H5CC-L8□ models.

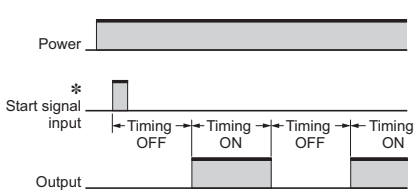
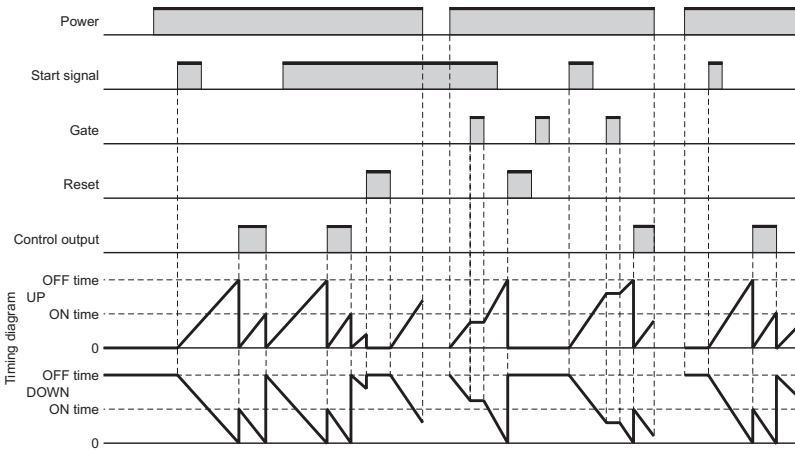
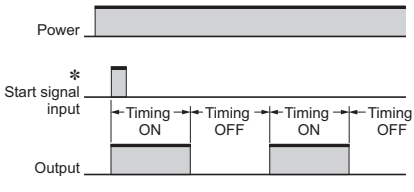
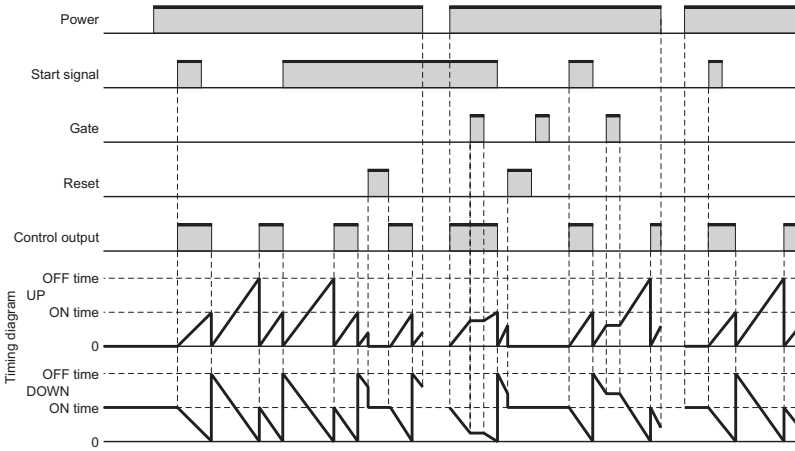
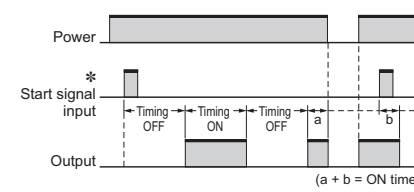
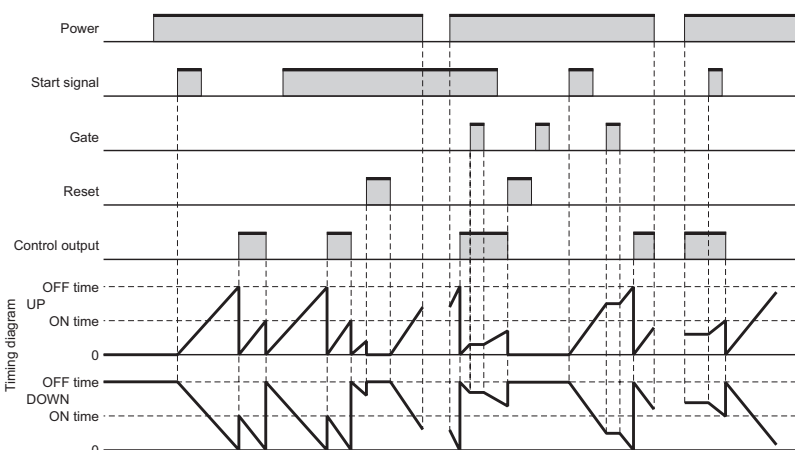
Mode toff: Flicker OFF start I (Timer resets when power comes ON.)	
Basic operation	Detailed operation
 <p>* Start signal input is disabled during timing.</p> <p>Timing starts when the start signal goes ON. The status of the control output is reversed when time is up (OFF at start). While the start signal is ON, the Timer starts when the power comes ON or when the reset input goes OFF.</p> <p>Note: Normal output operation will not be possible if the set time is too short. Set the ON time and OFF time to at least 100 ms (contact output type).</p>	
Mode ton: Flicker ON start I (Timer resets when power comes ON.)	
Basic operation	Detailed operation
 <p>* Start signal input is disabled during timing.</p> <p>Timing starts when the start signal goes ON. The status of the control output is reversed when time is up (ON at start). While the start signal is ON, the Timer starts when the power comes ON or when the reset input goes OFF.</p> <p>Note: Normal output operation will not be possible if the set time is too short. Set the ON time and OFF time to at least 100 ms (contact output type).</p>	
Mode toff-1: Flicker OFF start II (Timer does not reset when power comes ON.)	
Basic operation	Detailed operation
 <p>* Start signal input is disabled during timing.</p> <p>Timing starts when the start signal goes ON. The status of the control output is reversed when time is up (OFF at start). While the start signal is ON, the Timer starts when the power comes ON or when the reset input goes OFF.</p> <p>Note: Normal output operation will not be possible if the set time is too short. Set the ON time and OFF time to at least 100 ms (contact output type).</p>	

H5CC

Twin Timer

Mode ton-1: Flicker ON start II (Timer does not reset when power comes ON.)

Basic operation

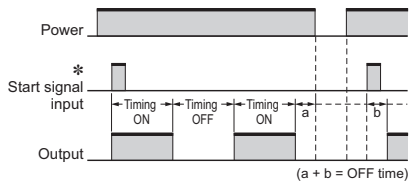

* Start signal input is disabled during timing.

Timing starts when the start signal goes ON.
The status of the control output is reversed when time is up (ON at start).
While the start signal is ON, the Timer starts when the power comes ON or when the reset input goes OFF.

Note: Normal output operation will not be possible if the set time is too short.
Set the ON time and OFF time to at least 100 ms (contact output type).

Detailed operation

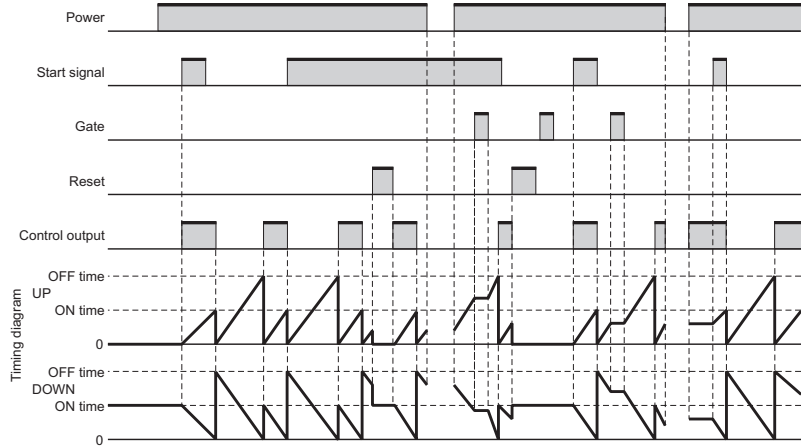

H5CC-L8E

Mode toff: Flicker OFF start I (Timer resets when power comes ON.)

Basic operation

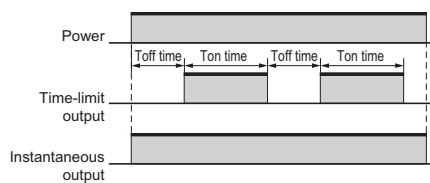

The Timer starts when the power comes ON or when the reset input goes OFF.

Note: Normal output operation will not be possible if the set time is too short.
Set the ON time and OFF time to at least 100 ms.

Detailed operation

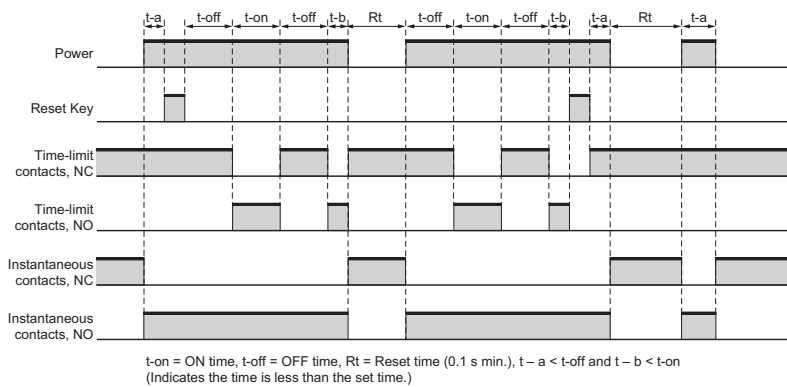

Mode ton: Flicker ON start I (Timer resets when power comes ON.)

Basic operation

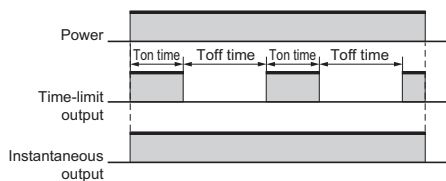

The Timer starts when the power comes ON or when the reset input goes OFF.

Note: Normal output operation will not be possible if the set time is too short.
Set the ON time and OFF time to at least 100 ms.

Detailed operation

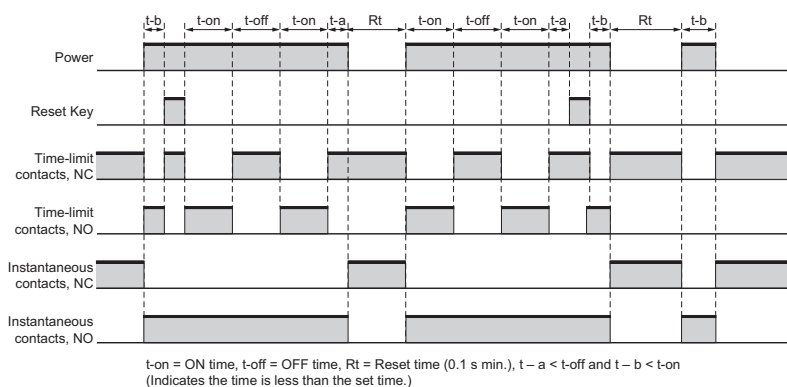

* H5CC-L8E Precautions

Set the Timer's set value before using the Timer in a self-holding circuit.

Timer/Twin Timer Selection Mode (Function Selection)

Select whether the H5CC is used as a timer or a twin timer in timer/twin timer selection mode.

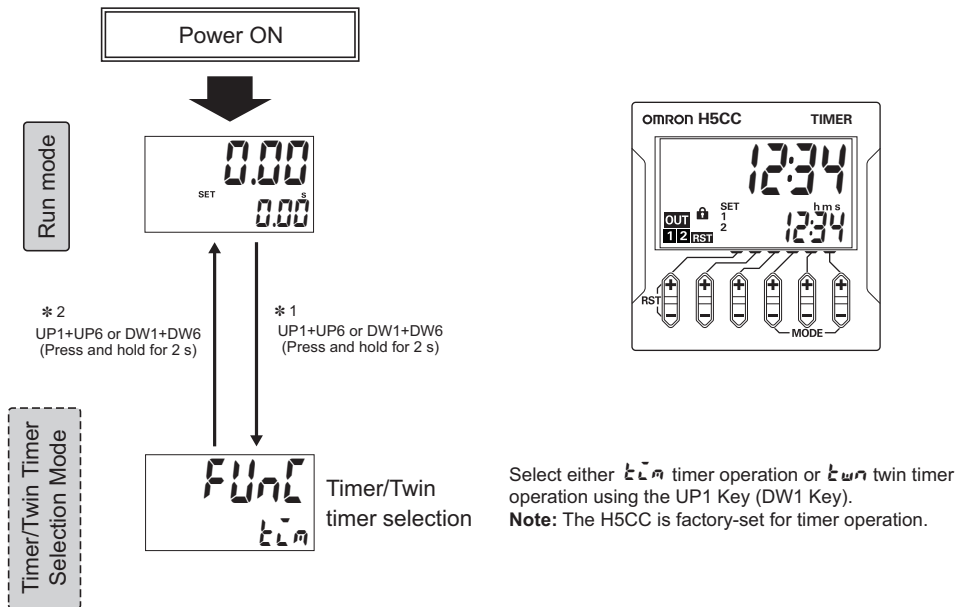

*1. When the mode is changed to timer/twin timer selection mode, the present value is reset and output turns OFF.

*2. Setting changes made in timer/twin timer selection mode are enabled when the mode is changed to run mode.

If the configuration is changed, the set values and set time are initialized. To initialize the set values and set time, set t (timer) \rightarrow t (twin timer) or t (twin timer) \rightarrow t (timer) in timer/twin timer selection mode, return to run mode, set t (twin time) \rightarrow t (timer) or t (timer) \rightarrow t (twin timer) in timer/twin timer selection mode again, and return to run mode. However, the output ON count monitor value ($\bar{a}n-L$, $\bar{a}n-IL$, or $\bar{a}n2L$) and cumulative run time monitor ($\bar{a}t-L$) are not initialized.

Operating Procedures of the H5CC-AWSD

Operation in Run Mode

Set the digits for the set values using the corresponding UP1 to UP6 Keys (DW1 to DW6 Keys).

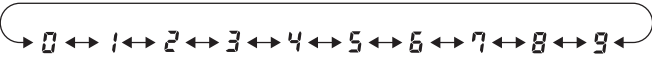

Forecast Value Setting

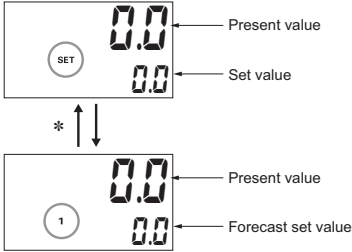

* Each time the UP1 + UP3 or DW1 + DW3 are pressed, the sub-display will switch between the set value ("SET" is lit) and the forecast set value ("1" is lit).

Absolute Value Setting

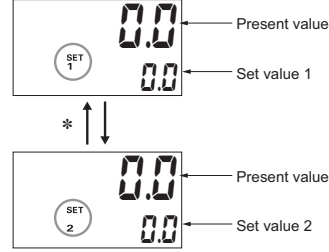

* Each time the UP1 + UP3 or DW1 + DW3 are pressed, the sub-display will switch between set value 1 ("SET 1" is lit) and set value 2 ("SET 2" is lit).

Operation in Function Setting Mode

Change to Function Setting Mode.

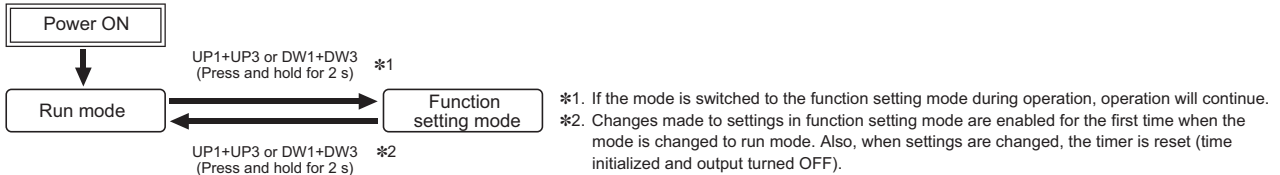

The characters displayed in reverse video are the default settings. In the function setting mode, the status indicators of the keys that can be set light up.

(Example) In the case of the set value upper limit

A value from 1 to 999999 can be set, and therefore the status indicators of the UP1 to UP6 Keys (DW1 to DW6 Keys) light up.

• Set the digits for the set values using the corresponding UP1 to UP6 Keys (DW1 to DW6 Keys).

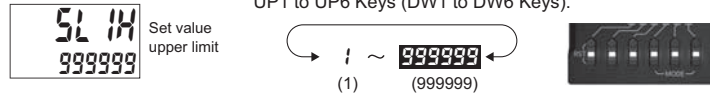

* Use UP1+UP3 to move up and DW1+DW3 to move down

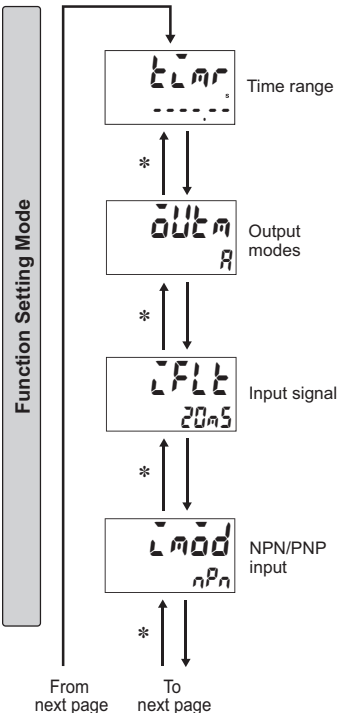

• Set the time range using the UP1 Key (DW1 Key).



• Set the output mode using the UP1 Key (DW1 Key).



• Set the input signal width using the UP1 Key (DW1 Key).

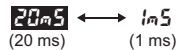

• Set the NPN/PNP mode using the UP1 Key (DW1 Key).

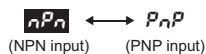

Time Range List

Display	Set Value
---:--:-- s	0.01 s to 9999.99 s (default setting)
---:--:-- s	0.1 s to 99999.9 s
---:--:-- s	1 s to 999999 s
---:--:-- h m s	0 h 0 min 01 s to 99 h 59 min 59 s
---:--:-- m	0.1 min to 99999.9 min
---:--:-- m	1 min to 999999 min
---:--:-- h m	0 h 01 min to 9999 h 59 min
---:--:-- h	0.1 h to 99999.9 h
---:--:-- h	1 h to 999999 h
---:--:-- s	0.001 s to 999.999 s

Function Setting Mode

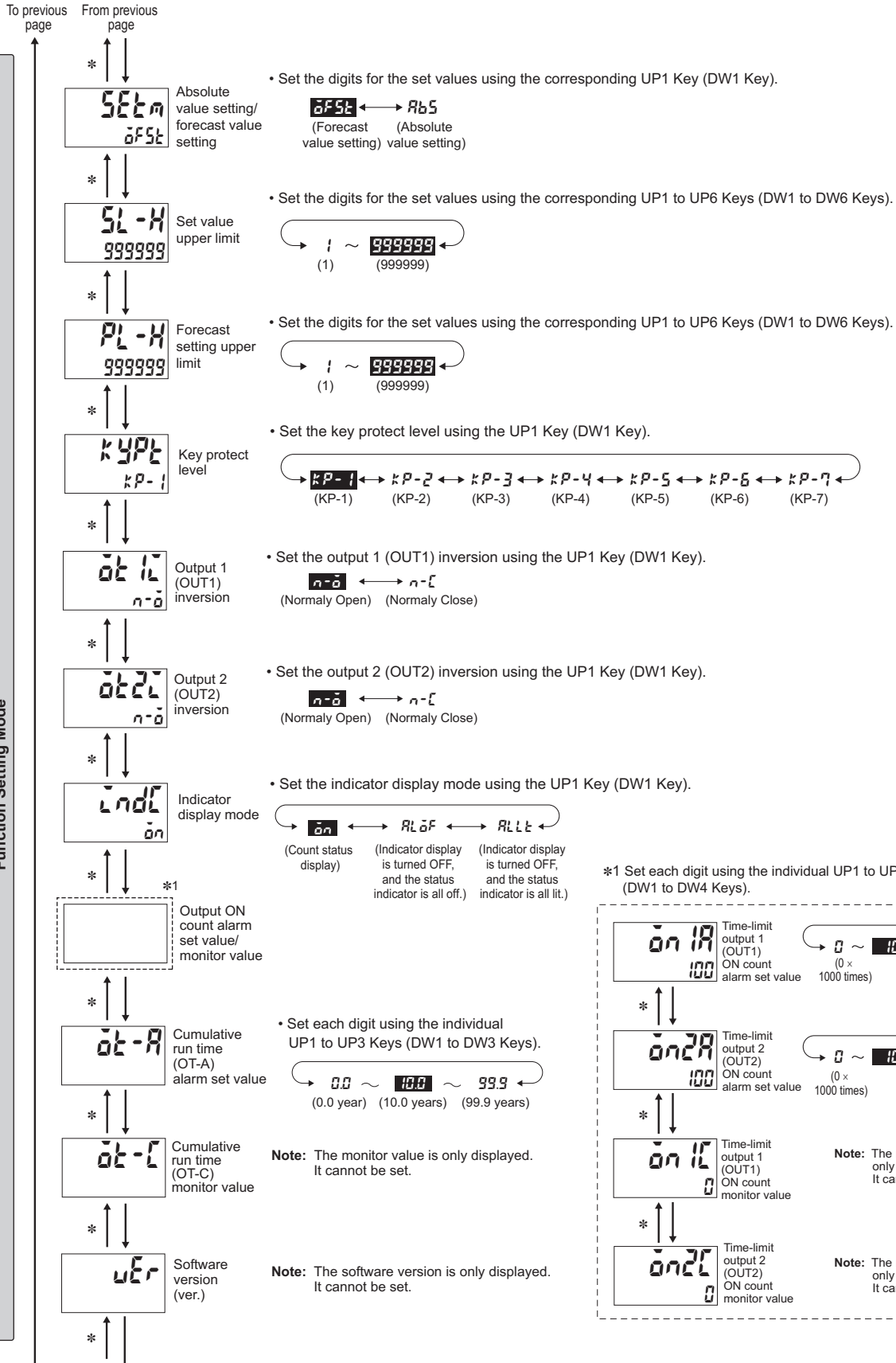

*1 Set each digit using the individual UP1 to UP4 Keys (DW1 to DW4 Keys).

<p>Screen: <code>on 1A</code> and <code>100</code></p> <p>Time-limit output 1 (OUT1) ON count alarm set value</p> <p>Range: <code>0</code> ~ <code>100</code> ~ <code>9999</code></p> <p>(0 x) (1000 times) (9999 x 1000 times)</p>	
<p>Screen: <code>on 2A</code> and <code>100</code></p> <p>Time-limit output 2 (OUT2) ON count alarm set value</p> <p>Range: <code>0</code> ~ <code>100</code> ~ <code>9999</code></p> <p>(0 x) (1000 times) (9999 x 1000 times)</p>	
<p>Screen: <code>on 1C</code> and <code>0</code></p> <p>Time-limit output 1 (OUT1) ON count monitor value</p> <p>Note: The monitor value is only displayed. It cannot be set.</p>	
<p>Screen: <code>on 2C</code> and <code>0</code></p> <p>Time-limit output 2 (OUT2) ON count monitor value</p> <p>Note: The monitor value is only displayed. It cannot be set.</p>	

Explanation of Functions (Refer to page 18 for the explanation of other functions.)

Absolute value setting/forecast value setting (5E6 m)

Set value 1 can be set as the forecast value setting (5F5k) or the absolute value setting (5B5).

Forecast Value Setting

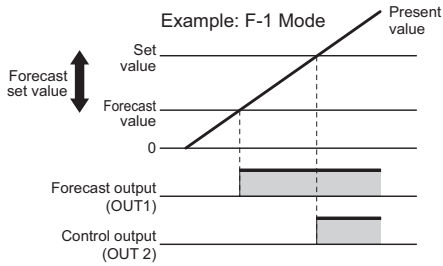

- OUT1 (forecast output) turns ON when the present value reaches the forecast value.
The forecast value = set value - forecast set value
* The forecast set value is used to set the deviation for the set value.
- OUT2 (control output) turns ON when the present value reaches the set value.
- If the forecast set value \geq set value, OUT1 (forecast output) will turn ON as soon as timing starts.

Absolute Value Setting

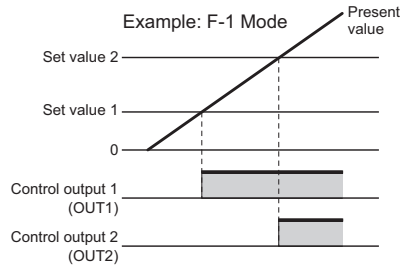

- OUT1 (control output 1) turns ON when the present value reaches set value 1.
- OUT2 (control output 2) turns ON when the present value reaches set value 2.

Refer to pages 18 and 29 for information on other functions.

Timing Charts

Mode A: Signal ON delay (Timer resets when power comes ON.)

Basic operation

* Start signal input is disabled during timing.

- Timing starts when the start signal goes ON.
- While the start signal is ON, the Timer starts when the power comes ON or when the reset input goes OFF.
- A sustained control output is used.
- Timing stops when the time is up.

Note: Output is instantaneous when the set value is 0.

Detailed operation

The names in parentheses are used for the absolute value setting.

Mode F-1: Cumulative (Timer does not reset when power comes ON.)

Basic operation

- Start signal enables timing (timing is stopped when the start signal is OFF or when the power is OFF).
- A sustained control output is used.
- Timing continues even after the time is up.

Note: Output is instantaneous when the set value is 0.

When the H5CC is used with power-ON start, there will be a timer error (approximately 100 ms each time the H5CC is turned ON) due to the characteristics of the internal circuit. Use the H5CC with signal start if timer accuracy is required.

Detailed operation

The names in parentheses are used for the absolute value setting.

Note: The forecast value = set value - forecast set value
* The forecast set value is used to set the deviation for the set value.

Replacement Time Notification Function

The Timer includes parts such as electrolytic capacitors and relays that deteriorate with time or with repeated operations. The H5CC is equipped with a function for notifying the replacement time by the cumulative run time and ON count of the relay contact.

When either one of the deterioration of the electrolytic capacitors due to the cumulative run time or the deterioration of the relay contact due to the output ON count reaches the replacement time, **RPLC** (REPLACE) can be displayed on the Timer. For details on RPLC display, refer to *Self-diagnosis Function* on this page.

Cumulative Run Time Alarm Set Value ($\bar{0}t - \bar{R}$)

The cumulative run time can be set in a range from 0.0 to 99.9 years. The replacement time notification function is disabled if 0 is set. 10 years is set in the default settings.

If the cumulative run time reaches the alarm set value or above, an RPLC (replacement time) error can be displayed on the Timer.

The extent of deterioration of electrolytic capacitors varies depending on the capacitor temperature and usage period. According to the default settings, the ambient temperature is 35°C, the output load is 50%, and the utilization rate is 100%. If you change the usage conditions to actual ones, use H5CC replacement time calculation tool on the OMRON website.

Output ON Count Alarm Set Value ($\bar{0}n - \bar{R}$, $\bar{0}n \bar{1}\bar{R}$, $\bar{0}n\bar{2}\bar{R}$)

Set the alarm value for the output ON count.

The limit can be set between $\underline{0} \times 1000$ (0 times) and $\underline{9999} \times 1000$ (9,999,000 times). Only the underlined values are set. The alarm will be disabled if 0 is set.

100,000 times is set in the default settings.

If the total output ON count reaches the alarm set value or above, an RPLC (replacement time) error can be displayed on the Timer.

Self-diagnostic Function

The following displays will appear if an error occurs.

Main display	Sub-display	Description	Output status	Correction method	Set value after reset
E1	Not lit	CPU error	OFF	Either perform reset operation or reset the power supply.	No change
E2	Not lit	Memory error (RAM)	OFF	Turn ON the power again.	No change
E2	SUm	Memory error (non-volatile memory) *1	OFF	Reset operation	Factory setting
RPLC *3	No change	The cumulative run time or output ON count reaches the replacement time	No change	Reset operation *2	No change

*1. This includes times when the life of the non-volatile memory has expired.

*2. This is displayed if the alarm value setting for either of the two outputs is exceeded if a model with two outputs is used. The total ON count will not be cleared by reset operation.

*3. The normal display and **RPLC** will appear alternately.

When reset operation is performed, **RPLC** will not be displayed even if the alarm set value is exceeded.

(Monitoring is possible, however, because the counter will continue without the cumulative run time and output ON count being cleared.)

RPLC is displayed again if the power is turned OFF/ON after the **RPLC** display is cleared during recovery by the reset operation. If you do not want to display **RPLC** when the power is turned OFF/ON, either change the alarm set value to the present value or above, or change the alarm set value to 0 to disable it.

Key Protect Level

When the key-protect switch is set to ON, it is possible to prevent setting errors by prohibiting the use of certain operation keys by specifying the key protect level (KP-1 to KP-7). The key protect level is set in the function setting mode. The key protect indicator is lit when the key-protect switch is ON.

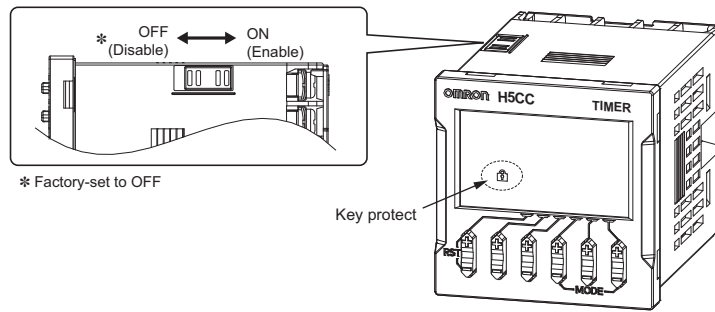

Level	Meaning	Details			
		Changing mode #1	Switching display during operation #2	Reset Key	Up/Down Keys
KP-1 (default setting)		Invalid	Valid	Valid	Valid
KP-2		Invalid	Valid	Invalid	Valid
KP-3		Invalid	Valid	Valid	Invalid
KP-4		Invalid	Valid	Invalid	Invalid
KP-5		Invalid	Invalid	Invalid	Invalid
KP-6		Invalid	Invalid	Valid	Valid
KP-7		Invalid	Invalid	Invalid	Valid

*1. Changing mode to configuration selection mode or function setting mode.

*2. Switching between SEt 1 (or SEt 2) and SEt 2 (or 1) in the operating mode when the operating mode is z, kOn, kOFF, kOn I, or kOF I.





Safety Precautions for All H5CC Series (Common)

Be sure to read the precautions for all Timers.

Warning Indications

 CAUTION	Indicates a potentially hazardous situation which, if not avoided, may result in minor or moderate injury or in property damage.
Precautions for Safe Use	Supplementary comments on what to do or avoid doing, to use the product safely.
Precautions for Correct Use	Supplementary comments on what to do or avoid doing, to prevent failure to operate, malfunction or undesirable effect on product performance.

Meaning of Product Safety Symbols

	Caution against electric shock Used to warn of the risk of electric shock under specific conditions.
	General prohibition Indicates the instructions of unspecified prohibited action.
	No disassembly Use to indicate prohibition when there is a risk of minor injury from electrical shock or other source if the product is disassembled.
	General instructions Used for general mandatory action precautions for which there is no specified symbol.

CAUTION

Do not allow pieces of metal, wire clippings, or fine metallic shavings or fillings from installation to enter the product. Doing so may occasionally result in electric shock, fire, or malfunction. 

Do not use the Timer where subject to flammable or explosive gas. Minor injury due to explosion may occasionally occur. 

Fire may occasionally occur. Tighten the terminal screws to the rated torque below. 

H5CC terminals and

P3GA-11/P3G-08 socket terminals

: 6.55 to 7.97 lb-in (0.74 to 0.90 N·m)

P2CF socket terminals: 4.4 lb-in (0.5 N·m)

Do not touch any of the terminals while power is being supplied. Be sure to mount the terminal cover after wiring. Minor injury due to electric shock may occasionally occur. 

The life expectancy of the output relay varies considerably according to its usage. Use the output relay within its rated load and electrical life expectancy. If the output relay is used beyond its life expectancy, its contacts may become fused or there may be a risk of fire. Also, be sure that the load current does not exceed the rated load current and when using a heater, be sure to use a thermal switch in the load circuit. 

Do not disassemble, modify, or repair the Timer or touch internal components. Minor electric shock, fire, or malfunction may occasionally occur. 

Precautions for Safe Use

- When mounting the Timer to a panel, tighten the two mounting screws alternately, a little at a time, so as to keep them at an equal tightness. If the panel screws are tightened unequally, water may enter the panel.

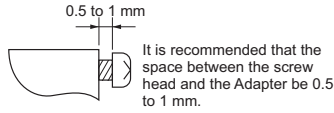

- Store the Timer at the specified temperature. If the Timer has been stored at a temperature of less than -10°C , allow the Timer to stand at room temperature for at least 3 hours before use.
- Mounting the Timer side-by-side may reduce the life expectancies of internal components.
- Use the Timer within the specified ranges for the ambient operating temperature and humidity.
- Do not use in the following locations:
 - Locations subject to sudden or extreme changes in temperature.
 - Locations subject to oil.
 - Locations where high humidity may result in condensation.
 - Locations prone to icing.
 - Locations with excessive vibration or shock.
 - Locations subject to exposure chemicals.
 - Locations subject to water.
 - Locations subject to bugs and small animals.
- Do not use this Timer in dusty environments, in locations where corrosive gasses are present, or in locations subject to direct sunlight.
- Install the Timer well away from any sources of static electricity, such as pipes transporting molding materials, powders, or liquids.
- Internal elements may be destroyed if a voltage outside the rated voltage range is applied.
- Be sure that polarity is correct when wiring the terminals.
- Separate the Timer from sources of noise, such as devices with input signals from power lines carrying noise, and wiring for I/O signals.
- Do not connect more than two crimp terminals to the same terminal.
- Up to two wires of the same size and type can be inserted into a single terminals.
- Use the specified wires for wiring. Applicable Wires: AWG 18 to AWG 22, solid or twisted, copper Stripping length: 5 to 6 mm (recommended)
- Install a switch or circuit breaker that allows the operator to immediately turn OFF the power, and label it to clearly indicate its function.
- When the Timer is operated with no-voltage input (NPN input) for models other than the H5CC-A11F, approximately 14 V is output from the input terminals. Use a sensor that contains a diode.

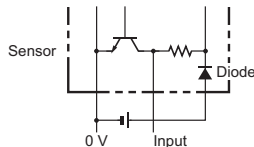

- Use a switch, relay, or other contact so that the rated power supply voltage will be reached within 0.1 seconds. If the power supply voltage is not reached quickly enough, the Timer may malfunction or outputs may be unstable.
- Use a switch, relay, or other contact to turn the power supply OFF instantaneously. Outputs may malfunction and memory errors may occur if the power supply voltage is decreased gradually.

H5CC-A□/-L□:

- When changing the set value during a timing operation, the output will turn ON if the set value is changed as follows because of the use of a constant read-in system:
 - Elapsed time (UP) mode: Present value \geq Set value
 - Remaining time (DOWN) mode: Elapsed time \geq Set value (The present value is set to 0.)
 When in the remaining time mode, the amount the set value is changed is added to or subtracted from the present value. Operation with a set value of 0 will vary with the output mode. Refer to the timing charts.

H5CC-AWSD:

- When changing the set value during a timing operation, the output will turn ON if the set value is changed as follows because of the use of a constant read-in system:
 - Forecast Value Setting
 - When the present value \geq the set value, OUT2 (control output) turns ON. When the present value \geq the forecast value (forecast value = set value - forecast set value), OUT1 (forecast output) turns ON.
 - Absolute Value Setting
 - When the present value \geq set value 2, OUT2 (control output 2) turns ON. When the present value \geq the forecast value 1, OUT1 (control output 1) turns ON. When the set value is 0, the output turns ON the moment the signal is input. The reset operation turns OFF the output. Refer to the timing charts.
- Do not use organic solvents (such as paint thinners or benzene), strong alkali, or strong acids. They will damage the external finish.
- Confirm that indications are working normally, including the backlight LED and LCD. The indicator LEDs, LCD, and resin parts may deteriorate more quickly depending on the application environment, preventing normal indications. Periodic inspection and replacement are required.
- The waterproof packing may deteriorate, shrink, or harden depending on the application environment. Periodic inspection and replacement are required.

Precautions for Correct Use

- Read this manual carefully before using the product.
- An inrush current of approx. 14 A will flow for a short time when the power supply is turned ON. If the capacity of the power supply is not sufficient, the Timer may not start. Be sure to use a power supply with sufficient capacity.
- Make sure the power supply voltage and loads are within the specifications and ratings for the product.
- When turning the power ON and OFF, input signal reception is possible, unstable, or impossible as shown in the diagram below. To allow for the startup time of peripheral devices (sensors, etc.), the Timer starts timing operation between 200 to 250 ms after power is turned ON. For this reason, in operations where timing starts from power ON, the time display will actually start from 249 ms. If the set value is 249 ms or less, the time until output turns ON will be a fixed value between 200 and 250. The present value display will start from 250 ms. (Normal operation is possible for set values of 250 ms or more.) In applications where a set value of 249 ms or less is required, use start timing with signal input.
- Note that the input signal will not be accepted after 5 to 505 ms has elapsed from when the power supply is turned OFF in the case of the H5CC-A□/L8□, after 5 to 105 ms has elapsed from when the power supply is turned OFF in the case of the H5CC-A11F, and after 5 to 1005 ms has elapsed from when the power supply is turned OFF in the case of the H5CC-AU□.

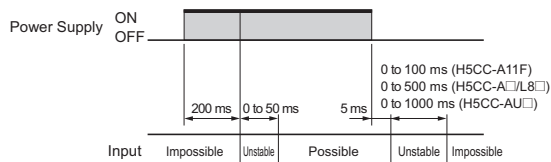

- Inrush current generated by turning ON or OFF the power supply may deteriorate contacts on the power supply circuit. Turn ON or OFF to a device with the rated current of more than 14 A.
- Make sure that all settings are appropriate for the application. Unexpected operation resulting in property damage or accidents may occur if the settings are not appropriate.
- Do not leave the Timer for long periods at a high temperature with output current in the ON state. Doing so may result in the premature deterioration of internal components (e.g., electrolytic capacitors). Do not install the product close contact with the heating element.
- Non-volatile memory is used as backup memory when the power is interrupted. The write life of the non-volatile memory is 100,000 writes. The non-volatile memory is written when the power is turned OFF or when switching from function setting mode or configuration selection mode to run mode.
- Dispose of the product according to local ordinances as they apply.
- Do not use because it may be damaged inside the product when the product fall by mistake.
- Check all wiring before you turn ON the power supply to the Timer.
- Doing so may cause incoming radio wave interference. Do not use the product near radio wave receivers.
- Install product so that the load doesn't span the product body.
- H5CC models with a 24 to 240-VAC/24 to 240-VDC power supply use a transformerless power supply system in which the power supply terminals are not isolated from the signal input terminals. Unwanted current paths may occasionally burn or destroy internal components depending on the wiring. Always check the wiring sufficiently before use.
- Do not wire the terminals which are not used.
- If there is a transformer or other device with a large inductance component on the power line, the inductance will cause a reverse voltage. If that occurs, insert a CR filter in the power line to reduce the reverse voltage.

- Do not use in a circuit with the waveform that is distorted. The error will increase due to the influence of the distorted waveform.
- The capacity of the external power supply is 100 mA at 12 V. When using an H5CC-AUD external power supply, reduce the load with the power supply voltage, as shown in the following diagram (DC power supplies only).

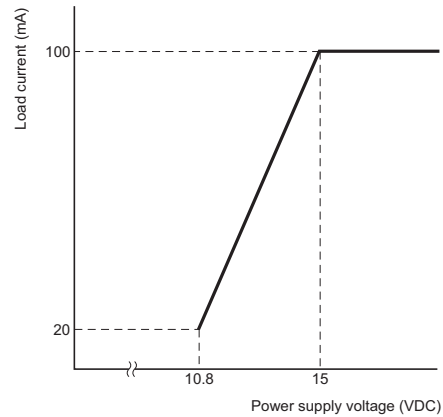

Conformance to EN/IEC Standards

- When conforming to EMC standards, refer to the information provided in this datasheet for cable selection and other conditions.
- This is a class A product. In residential areas it may cause radio interference, in which case the user may be required to take adequate measures to reduce interference.
- Basic insulation is provided between the power supply and input terminals. (No insulation is provided between the power supply and input terminals for the H5CC-A11F.) Basic insulation is provided between power supply and output terminals, and between input and output terminals.
- When double insulation or reinforced insulation is required, apply double insulation or reinforced insulation as defined in IEC 60664 that is suitable for the maximum operating voltage with clearances or solid insulation.
- Connect the input and output terminals to devices that do not have any exposed charged parts.

Terms and Conditions Agreement

Read and understand this catalog.

Please read and understand this catalog before purchasing the products. Please consult your OMRON representative if you have any questions or comments.

Warranties.

(a) Exclusive Warranty. Omron's exclusive warranty is that the Products will be free from defects in materials and workmanship for a period of twelve months from the date of sale by Omron (or such other period expressed in writing by Omron). Omron disclaims all other warranties, express or implied.

(b) Limitations. OMRON MAKES NO WARRANTY OR REPRESENTATION, EXPRESS OR IMPLIED, ABOUT NON-INFRINGEMENT, MERCHANTABILITY OR FITNESS FOR A PARTICULAR PURPOSE OF THE PRODUCTS. BUYER ACKNOWLEDGES THAT IT ALONE HAS DETERMINED THAT THE PRODUCTS WILL SUITABLY MEET THE REQUIREMENTS OF THEIR INTENDED USE.

Omron further disclaims all warranties and responsibility of any type for claims or expenses based on infringement by the Products or otherwise of any intellectual property right. (c) Buyer Remedy. Omron's sole obligation hereunder shall be, at Omron's election, to (i) replace (in the form originally shipped with Buyer responsible for labor charges for removal or replacement thereof) the non-complying Product, (ii) repair the non-complying Product, or (iii) repay or credit Buyer an amount equal to the purchase price of the non-complying Product; provided that in no event shall Omron be responsible for warranty, repair, indemnity or any other claims or expenses regarding the Products unless Omron's analysis confirms that the Products were properly handled, stored, installed and maintained and not subject to contamination, abuse, misuse or inappropriate modification. Return of any Products by Buyer must be approved in writing by Omron before shipment. Omron Companies shall not be liable for the suitability or unsuitability or the results from the use of Products in combination with any electrical or electronic components, circuits, system assemblies or any other materials or substances or environments. Any advice, recommendations or information given orally or in writing, are not to be construed as an amendment or addition to the above warranty.

See <http://www.omron.com/global/> or contact your Omron representative for published information.

Limitation on Liability; Etc.

OMRON COMPANIES SHALL NOT BE LIABLE FOR SPECIAL, INDIRECT, INCIDENTAL, OR CONSEQUENTIAL DAMAGES, LOSS OF PROFITS OR PRODUCTION OR COMMERCIAL LOSS IN ANY WAY CONNECTED WITH THE PRODUCTS, WHETHER SUCH CLAIM IS BASED IN CONTRACT, WARRANTY, NEGLIGENCE OR STRICT LIABILITY.

Further, in no event shall liability of Omron Companies exceed the individual price of the Product on which liability is asserted.

Suitability of Use.

Omron Companies shall not be responsible for conformity with any standards, codes or regulations which apply to the combination of the Product in the Buyer's application or use of the Product. At Buyer's request, Omron will provide applicable third party certification documents identifying ratings and limitations of use which apply to the Product. This information by itself is not sufficient for a complete determination of the suitability of the Product in combination with the end product, machine, system, or other application or use. Buyer shall be solely responsible for determining appropriateness of the particular Product with respect to Buyer's application, product or system. Buyer shall take application responsibility in all cases.

NEVER USE THE PRODUCT FOR AN APPLICATION INVOLVING SERIOUS RISK TO LIFE OR PROPERTY OR IN LARGE QUANTITIES WITHOUT ENSURING THAT THE SYSTEM AS A WHOLE HAS BEEN DESIGNED TO ADDRESS THE RISKS, AND THAT THE OMRON PRODUCT(S) IS PROPERLY RATED AND INSTALLED FOR THE INTENDED USE WITHIN THE OVERALL EQUIPMENT OR SYSTEM.

Programmable Products.

Omron Companies shall not be responsible for the user's programming of a programmable Product, or any consequence thereof.

Performance Data.

Data presented in Omron Company websites, catalogs and other materials is provided as a guide for the user in determining suitability and does not constitute a warranty. It may represent the result of Omron's test conditions, and the user must correlate it to actual application requirements. Actual performance is subject to the Omron's Warranty and Limitations of Liability.

Change in Specifications.

Product specifications and accessories may be changed at any time based on improvements and other reasons. It is our practice to change part numbers when published ratings or features are changed, or when significant construction changes are made. However, some specifications of the Product may be changed without any notice. When in doubt, special part numbers may be assigned to fix or establish key specifications for your application. Please consult with your Omron's representative at any time to confirm actual specifications of purchased Product.

Errors and Omissions.

Information presented by Omron Companies has been checked and is believed to be accurate; however, no responsibility is assumed for clerical, typographical or proofreading errors or omissions.

Note: Do not use this document to operate the Unit.

OMRON Corporation Industrial Automation Company

Kyoto, JAPAN

Contact : www.ia.omron.com

Regional Headquarters

OMRON EUROPE B.V.

Wegalaan 67-69, 2132 JD Hoofddorp
The Netherlands
Tel: (31) 2356-81-300 Fax: (31) 2356-81-388

OMRON ELECTRONICS LLC

2895 Greenspoint Parkway, Suite 200
Hoffman Estates, IL 60169 U.S.A.
Tel: (1) 847-843-7900 Fax: (1) 847-843-7787

OMRON ASIA PACIFIC PTE. LTD.

438B Alexandra Road, #08-01/02 Alexandra
Technopark, Singapore 119968
Tel: (65) 6835-3011 Fax: (65) 6835-3011

OMRON (CHINA) CO., LTD.

Room 2211, Bank of China Tower,
200 Yin Cheng Zhong Road,
PuDong New Area, Shanghai, 200120, China
Tel: (86) 21-6023-0333 Fax: (86) 21-5037-2388

Authorized Distributor:

©OMRON Corporation 2023-2024 All Rights Reserved.
In the interest of product improvement,
specifications are subject to change without notice.

CSM_2_1

Cat. No. L220-E1-02 0124 (0323)