

# Miniature Power Relays MY Series

**Best-selling, general-purpose relays that can be selected based on operating environment and application**

- Wiring work can be shortened by as much as 60%\* compared to conventional screw terminal sockets by combining with push-in plus terminal sockets (PYF-□-PU) that feature light insertion force and strong pull-out strength to achieve less wiring work.
- In addition to our standard type (MY-GS-R), an abundant lineup of models including latching relays that retain contact operation status (MYK) and sealed relays suitable for environments where dust and corrosive gases are present (MYQ/MYH) are also available.
- Selection is possible to suit the application, such as models with operation indicators and models with latching levers (MY-GS-R).

\* When both push-in plus terminals and screw terminal sockets are combined with plug-in terminal types (according to actual OMRON measurements as of November 2015)

 Refer to *Safety Precautions* on pages 62 to 63 and *Safety Precautions for All Relays*.



Refer to the standards certifications and compliance section of your OMRON website for the latest information on certified models.

## Miniature Power Relay Types

MY-GS-R Miniature Power Relays .....	From page 4
MY(S) Miniature Power Relays.....	From page 13
MYK Miniature Power Latching Relays.....	From page 32
MYQ/MYH Miniature Power Sealed Relays .....	From page 37

## Common Information

Common Options (Order Separately).....	From page 43
Common Safety Precautions .....	From page 62

Model List

Selection

Use this as reference when selecting the model.

MY-GS-R

MY(S)

MYK

MYQ-MYH

Common Options (Order Separately)

Common Precautions

Firstly Choice!

This general-purpose model can be used for a wide range of applications

MY-GS-R

page 4



Choose this model if you want to properly control a microload!

MY□Z Bifurcated contacts  
MY□Z-CBG Crossbar bifurcated contacts

page 13



Choose this model if you want to maintain the operation status of the contact!

MYK Latching Relays

page 32



Choose this model in an environment with a large amount of corrosive gases and dust!

MYQ Plastic Sealed Relays  
MYH Hermetically Sealed Relays  
page 37



Miniature Power Relays: MY

Classification	Number of poles	Contacts	Plug-in terminals			PCB terminals	Case-surface mounting			
			Standard	With operation indicator	With latching lever					
Standard models	2	Single	MY2-GS-R	MY2N-GS-R	MY2IN-GS-R	MY2-02	MY2F			
		Bifurcated	MY2Z	MY2ZN						
	3	Single	MY3	MY3N		MY3-02	MY3F			
		4	Single	MY4-GS-R	MY4N-GS-R			MY4IN-GS-R	MY4-02	MY4F
			Bifurcated	MY4Z(S)	MY4ZN(S)			MY4ZIN(S)		
	Crossbar bifurcated	MY4Z-CBG	MY4ZN-CBG							
Models with built-in diode for coil surge absorption	Type 1 	2	Single		MY2N-D2-GS-R	MY2IN-D2-GS-R				
			Bifurcated		MY2ZN-D2					
		3	Single		MY3N-D2					
	Type 2 	4	Single		MY4N-D2-GS-R	MY4IN-D2-GS-R				
			Bifurcated		MY4ZN-D2(S)	MY4ZIN-D2(S)				
		2	Single		MY2N1-D2(S)	MY2IN1-D2(S)				
Models with built-in CR circuit for coil surge absorption	4	Single		MY4N1-D2(S)	MY4IN1-D2(S)					
		Bifurcated		MY4ZN1-D2(S)	MY4ZIN1-D2(S)					
		2	Single		MY2N-CR-GS-R	MY2IN-CR-GS-R				
	4	Single		MY4N-CR-GS-R	MY4IN-CR-GS-R					
		Bifurcated		MY4ZN-CR(S)	MY4ZIN-CR(S)					

Miniature Power Latching Relays (MYK)

Classification	Number of poles	Contacts	Plug-in terminals		PCB terminals
				With operation indicator	
Standard models	2	Single	MY2K		MY2K-02

Miniature Power Sealed Relays (MYQ/MYH)

Classification	Number of poles	Contacts	Plug-in terminals		PCB terminals
				With operation indicator	
Plastic Sealed Relays	4	Single	MYQ4	MYQ4N	MYQ4-02
		Bifurcated	MYQ4Z		MYQ4Z-02
Hermetically Sealed Relays	4	Single	MY4H		MY4H-0
		Bifurcated	MY4ZH		MY4ZH-0

Refer to Front-connecting Sockets and Back-connecting Sockets in *Common Options (Order Separately)* on pages 43 and 45 for main unit and socket combinations.

MY-GS-R

MY(S)

MYK

MYQ-MYH

Common Options (Order Separately)

Common Precautions

# MY-GS-R

MY-GS-R

MY(S)

MYK

MYQ-MYH

Common Options (Order Separately)

Common Precautions

## Mechanical Indicators Added as a Standard Feature to Our Best-selling MY General-purpose Relays



- A lineup of models with latching levers added for easier circuit checking.
- Reduces wiring work by 60% when combined with the PYF-PU Push-In Plus Socket (according to actual OMRON measurements).
- Relays with AC and DC coils have different colors of operating indicators (LEDs).
- Printing on the coil tape indicates the operating coil specification.
- Mechanical operation indicators are a standard feature on all models.
- UL, CSA, IEC (VDE certification), and CQC.

Refer to the *Common Relay Precautions*.

## Features

### Common to all specifications

- Mechanical indicators are a standard feature on all models so that you can easily check the contact status.
- The color of the LED shows whether the coil voltage is AC or DC.

Mechanical indicators (one on left and one on right)

Contacts ON (coil energized)

Contacts OFF (coil de-energized)

LED operation indicator  
Relay with AC coil: Red  
Relay with DC coil: Green



Relay with AC Coil (LED: Red)



Relay with AC Coil (LED: Red)



Relay with DC Coil (LED: Green)

### With latching lever

- Useful for the operation check of relay sequence circuits.
- The coil voltage AC/DC can be identified by the color of the latching lever (AC coil specification: red, DC coil specification: Blue).

### Latching lever operating method

	Normal State	Mode 1: Momentary State	Mode 2: Locked State
When seen from the top			
When seen from the side			
Operation Description	---	Slide the lever one step and press the yellow button with an insulated tool to operate the contacts.	If you slide the lever two steps, the contacts lock in the operation position.

## Model Number Structure

### Model Number Legend

MY □ □ □ - □ □ - GS - R DC24

1    2    3                      4    5

1. Number of Poles  
2: 2 poles  
4: 4 poles
2. Latching Lever  
Blank: Without latching lever  
I: With latching lever
3. LED Operation Indicator  
Blank: Built-in mechanical indicators  
N: LED operation indicator and built-in mechanical indicators
4. Coil Surge Absorption  
Blank: Standard models  
D2: Models with built-in diodes  
CR: Models with built-in CR circuits
5. Operating Coil Voltage  
Display Example: DC24

## List of Models

### Miniature Power Relays (MY-GS-R)

Category	Number of poles	Contact structure	Plug-in (octal pins) terminals		
				With operation indicator	
				With latching lever	
Standard models	2	Single	MY2-GS-R	MY2N-GS-R	MY2IN-GS-R
	4		MY4-GS-R	MY4N-GS-R	MY4IN-GS-R
Models with built-in diodes for coil surge absorption	2		---	MY2N-D2-GS-R	MY2IN-D2-GS-R
	4		---	MY4N-D2-GS-R	MY4IN-D2-GS-R
Models with built-in CR circuits for coil surge absorption	2		---	MY2N-CR-GS-R	MY2IN-CR-GS-R
	4		---	MY4N-CR-GS-R	MY4IN-CR-GS-R

MY-GS-R

MY(S)

MYK

MYQ-MYH

Common Options (Order Separately)

Common Precautions

# MY-GS-R

## Ordering Information

### Main unit

#### Standard model without operation indicator

Number of poles	Model	Rated voltage (V)
2	MY2-GS-R	12, 24, 48, 100/110, 110/120, 200/220, 220/240 VAC 6, 12, 24, 48, 100/110 VDC
4	MY4-GS-R	12, 24, 48, 100/110, 110/120, 200/220, 220/240 VAC 6, 12, 24, 48, 100/110 VDC

#### Standard model with operation indicator

Number of poles	Model	Rated voltage (V)
2	MY2N-GS-R	12, 24, 48, 100/110, 110/120, 200/220, 220/240 VAC 6, 12, 24, 48, 100/110, 220 VDC
4	MY4N-GS-R	12, 24, 48, 100/110, 110/120, 200/220, 220/240 VAC 6, 12, 24, 48, 100/110, 220 VDC

#### Standard model with operation indicator and latching lever

Number of poles	Model	Rated voltage (V)
2	MY2IN-GS-R	12, 24, 48, 100/110, 110/120, 200/220, 220/240 VAC 6, 12, 24, 48, 100/110, 220 VDC
4	MY4IN-GS-R	12, 24, 48, 100/110, 110/120, 200/220, 220/240 VAC 6, 12, 24, 48, 100/110, 220 VDC

#### Models with built-in diodes for coil surge absorption with operation indicator

Number of poles	Model	Rated voltage (V)
2	MY2N-D2-GS-R	12, 24, 48, 100/110, 220 VDC
4	MY4N-D2-GS-R	12, 24, 48, 100/110, 220 VDC

#### Models with built-in diodes for coil surge absorption with operation indicator and latching lever

Number of poles	Model	Rated voltage (V)
2	MY2IN-D2-GS-R	12, 24, 48, 100/110, 220 VDC
4	MY4IN-D2-GS-R	12, 24, 48, 100/110, 220 VDC

#### Models with built-in CR circuits for coil surge absorption with operation indicator

Number of poles	Model	Rated voltage (V)
2	MY2N-CR-GS-R	100/110, 110/120, 200/220, 220/240 VAC
4	MY4N-CR-GS-R	100/110, 110/120, 200/220, 220/240 VAC

#### Models with built-in CR circuits for coil surge absorption with operation indicator and latching lever

Number of poles	Model	Rated voltage (V)
2	MY2IN-CR-GS-R	100/110, 110/120, 200/220, 220/240 VAC
4	MY4IN-CR-GS-R	100/110, 110/120, 200/220, 220/240 VAC

MY-GS-R

MY(S)

MYK

MYQ-MYH

Common Options (Order Separately)

Common Precautions

# Ratings and Specifications

## Ratings

### Main unit

#### Operating Coil

Item	Rated current (mA)		Coil resistance (Ω)	Coil inductance (H)		Must-operate voltage	Must-release voltage	Maximum voltage	Power consumption (VA, W)	
	50 Hz	60 Hz		Armature OFF	Armature ON					
Rated voltage	Percentage of rated voltage									
AC	12	106.5	91	46	0.17	0.33	80% max. *1	30% min. *2	110%	Approx. 0.9 to 1.3 (at 60 Hz)
	24	53.8	46	180	0.69	1.3				
	48	25.7	21.1	788	3.22	5.66				
	100/110	11.7/12.9	10.0/11.0	3,750	14.54	24.6				
	110/120	9.9/10.8	8.4/9.2	4,430	19.2	32.1				
	200/220	6.2/6.8	5.3/5.8	12,950	54.75	94.07				
	220/240	5.2/6.2	4.3/5.0	15,920	83.5	136.4				
DC	6	146 (151)		41.0 (39.8)	0.17	0.33	10% min. *2			Approx. 0.9
	12	72.7 (75)		165 (160)	0.73	1.37				
	24	36.3 (37.7)		662 (636)	3.2	5.72				
	48	17.6 (18.8)		2,725 (2,560)	10.6	21.0				
	100/110	8.7 (9.0)/9.6 (9.9)		11,440 (11,100)	45.6	86.2				
	220	3.6		60,394	362.3	452.9				

- Note:**
- The rated current and coil resistance are measured at a coil temperature of 23°C with tolerances of +15%/–20% for the AC rated current and +15% for the DC coil resistance.
  - The AC coil resistance and inductance values are reference values only (at 60 Hz).
  - Operating characteristics were measured at a coil temperature of 23°C.
  - The values in parentheses for the rated currents and coil voltages of DC coils are for models with LED operation indicators.
  - The maximum voltage capacity was measured at an ambient temperature of 23°C.

- \*1. There is variation between products, but actual values are 80% max.  
The Relay will operate if 80% or higher of the rated voltage is applied. However, to achieve the specified characteristics, apply the rated voltage to the coil.
- \*2. There is variation between products, but actual values are 30% minimum for AC and 10% minimum for DC. To ensure release, use a value that is lower than the specified value.

### Contacts

	2 poles			4 poles		
	Resistive load	Inductive load (cos φ = 0.4, L/R = 7 ms)		Resistive load	Inductive load (cos φ = 0.4, L/R = 7 ms)	
Contact configuration	DPDT			4PDT		
Contact structure	Single					
Contact material	Ag					
Rated load	10 A at 250 VAC 10 A at 30 VDC	5 A at 220 VAC 5 A at 24 VDC	2 A at 220 VAC 2 A at 24 VDC	6 A at 250 VAC 6 A at 30 VDC	3 A at 220 VAC 3 A at 24 VDC	0.8 A at 220 VAC 1.5 A at 24 VDC
Electrical endurance *1	100,000 operations	500,000 operations		30,000 operations	200,000 operations	
Rated carry current	10 A			6 A *2		
Maximum contact voltage	250 VAC, 220 VDC			250 VAC, 220 VDC		
Maximum contact current	10 A			6 A *2		
Maximum switching capacity	2,500 VA 300 W	440 VA 48 W		1,500 VA 180 W	176 VA 36 W	
Minimum load (reference values) *3	1 mA at 5 VDC					

- \*1. Rated load, switching frequency: 2,400 operations/h. Ambient temperature condition: 23°C. Duty ratio: 33%.
- \*2. 4 poles of 6 A is for an ambient temperature of 50°C. At an ambient temperature of 70°C, the value is 3 A.
- \*3. These values are guides for the switchable limits for minute load levels, such as in electronic circuits. Actual characteristics may be different. These values will depend on the switching frequency, atmosphere, and expected reliability level. Confirm applicability in the actual system under actual application conditions.

MY-GS-R

MY(S)

MYK

MYQ-MYH

Common Options (Order Separately)

Common Precautions

Characteristics

Main unit

		2 poles	4 poles
Contact resistance *1		100 mΩ max.	
Operation time *2		20 ms max.	
Release time *2		20 ms max.	
Maximum operating frequency	Mechanical	18,000 operations/h	
	Rated load	2,400 operations/h	
Insulation resistance *3		1,000 MΩ min.	
Dielectric strength	Between coil and contacts	2,000 VAC at 50/60 Hz for 1 min.	
	Between contacts of different polarity	2,000 VAC at 50/60 Hz for 1 min.	
	Between contacts of the same polarity	1,000 VAC at 50/60 Hz for 1 min.	
Vibration resistance	Destruction	10 to 55 to 10 Hz, Double amplitude: 1.0 mm	
	Malfunction	10 to 55 to 10 Hz, Double amplitude: 1.0 mm	
Shock resistance	Destruction	1,000 m/s <sup>2</sup> (approx. 100 G)	
	Malfunction	200 m/s <sup>2</sup> (Approx. 20 G)	
Mechanical endurance		50,000,000 operations (switching frequency: 18,000 operations/h)	
Ambient operating temperature		Standard models: -55 to 70°C (with no icing or condensation) Models with LED operation indicators: -40 to 70°C (with no icing or condensation)	
Ambient humidity		5% to 85%	
Weight		Approx. 35 g	

Note: The above values are initial values.

\*1. Measurement conditions: 1 A at 5 VDC using the voltage drop method.

\*2. Measurement conditions: With rated operating power applied, not including contact bounce time.

\*3. Measurement conditions: For 500 VDC applied to the same location as for dielectric strength measurement.

Certified Ratings for Models Certified for Safety Standards

The rated values for safety standard certification are not the same as individually defined performance values. Always check the specifications before use.

Main unit

UL-certified Models: UL508

MY-GS	Number of poles	Coil ratings	Contact ratings	Certified number of operations
	2	12 VAC, 24 VAC, 48 VAC, 100/110 VAC, 110/120 VAC, 200/220 VAC, or 220/240 VAC 6 VDC, 12 VDC, 24 VDC, 48 VDC, 100/110 VDC, or 220 VDC	5 A, 30 VDC (General Use) 10 A, 30 VDC (General Use) 5 A, 250 VAC (General Use) 10 A, 250 VAC (General Use)	6,000 operations
	4	12 VAC, 24 VAC, 48 VAC, 100/110 VAC, 110/120 VAC, 200/220 VAC, or 220/240 VAC 6 VDC, 12 VDC, 24 VDC, 48 VDC, 100/110 VDC, or 220 VDC	3 A, 30 VDC (General Use) 6 A, 30 VDC Resistive Load 3 A, 250 VAC (General Use) 6 A, 250 VAC Resistive Load	6,000 operations

CSA-certified Models: CSA C22.2 No.14

MY-GS	Number of poles	Coil ratings	Contact ratings	Certified number of operations
	2	12 VAC, 24 VAC, 48 VAC, 100/110 VAC, 110/120 VAC, 200/220 VAC, or 220/240 VAC 6 VDC, 12 VDC, 24 VDC, 48 VDC, 100/110 VDC, or 220 VDC	5 A, 30 VDC (General Use) 10 A, 30 VDC (General Use) 5 A, 250 VAC (General Use) 10 A, 250 VAC (General Use)	6,000 operations
	4	12 VAC, 24 VAC, 48 VAC, 100/110 VAC, 110/120 VAC, 200/220 VAC, or 220/240 VAC 6 VDC, 12 VDC, 24 VDC, 48 VDC, 100/110 VDC, or 220 VDC	3 A, 30 VDC (General Use) 6 A, 30 VDC Resistive Load 3 A, 250 VAC (General Use) 6 A, 250 VAC Resistive Load	6,000 operations

VDE-certified Models: EN 61810-1

MY-GS	Number of poles	Coil ratings	Contact ratings	Certified number of operations
	2	12 VAC, 24 VAC, 48 VAC, 100/110 VAC, 110/120 VAC, 200/220 VAC, or 220/240 VAC 6 VDC, 12 VDC, 24 VDC, 48 VDC, 100/110 VDC, or 220 VDC	10 A, 30 VDC (L/R = 0) 10 A, 250 VAC (cosφ = 1)	10,000 operations
	4	12 VAC, 24 VAC, 48 VAC, 100/110 VAC, 110/120 VAC, 200/220 VAC, or 220/240 VAC 6 VDC, 12 VDC, 24 VDC, 48 VDC, 100/110 VDC, or 220 VDC	6 A, 30 VDC (L/R = 0) 6 A, 250 VAC (cosφ = 1)	10,000 operations

CQC-certified Models

Model	Standard number	Certification No.
MY-GS	GB/T 21711.1	CQC18002198531



# Engineering Data (Reference Value)

## Maximum Switching Capacity

MY2□□-□□-GS-R (AC load)

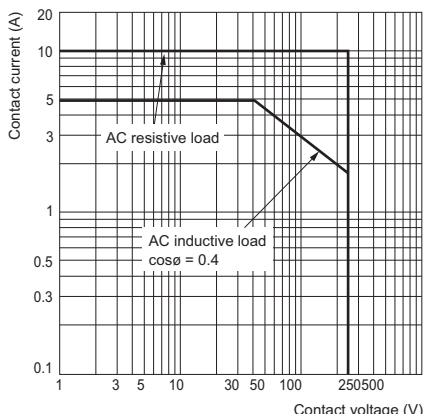

MY2□□-□□-GS-R (DC load)

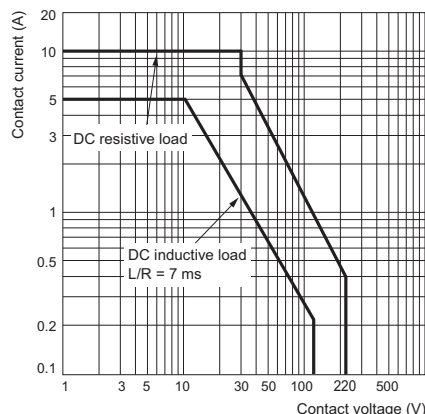

MY4□□-□□-GS-R (AC load)

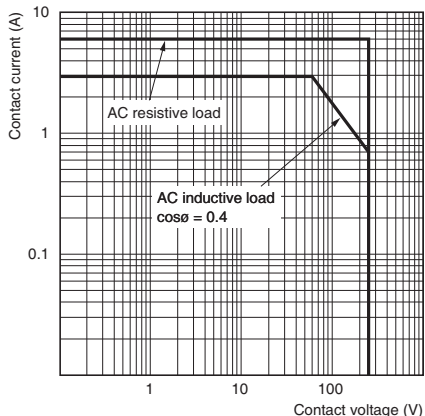

MY4□□-□□-GS-R (DC load)

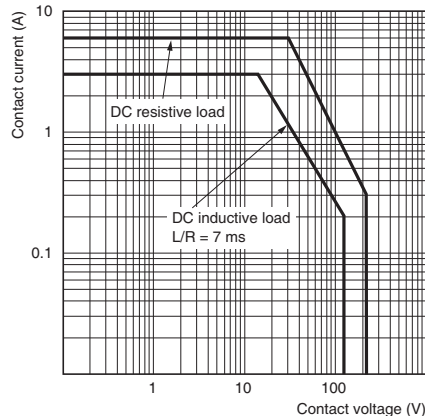

MY-GS-R

MY(S)

MYK

MYQ-MYH

Common Options (Order Separately)

Common Precautions

MY-GS-R

MY(S)

MYK

MYQ-MYH

Common Options (Order Separately)

Common Precautions

## Endurance Curve

### MY2□□-□□-GS-R (Resistive Load)

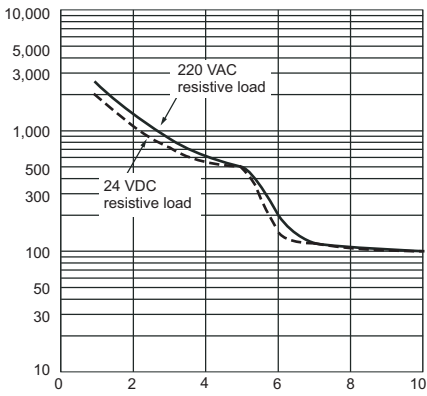

### MY2□□-□□-GS-R (Inductive Load)

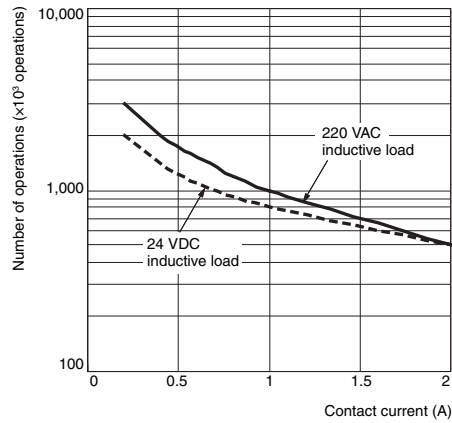

### MY4□□-□□-GS-R (Resistive Load)

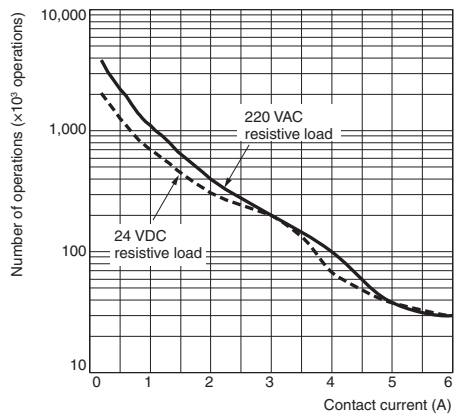

### MY4□□-□□-GS-R (Inductive Load)

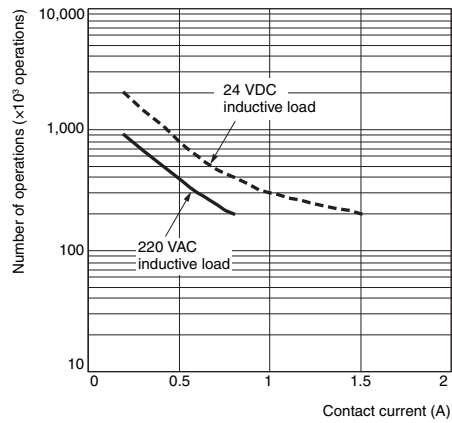

- Note:** 1. Number of operations: AC load, 50 Hz, 80%  
 2. Switching condition: NO or NC

Ambient Temperature vs. Must-operate and Must-release Voltage

MY2□□-□□-GS-R AC Models

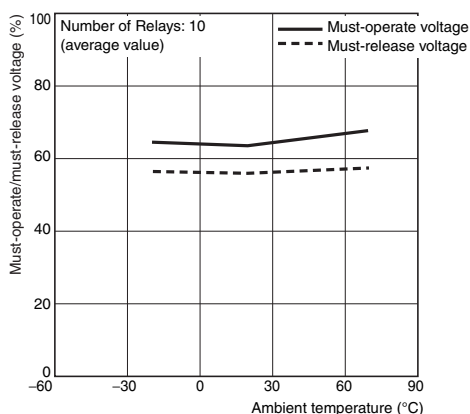

MY2□□-□□-GS-R DC Models

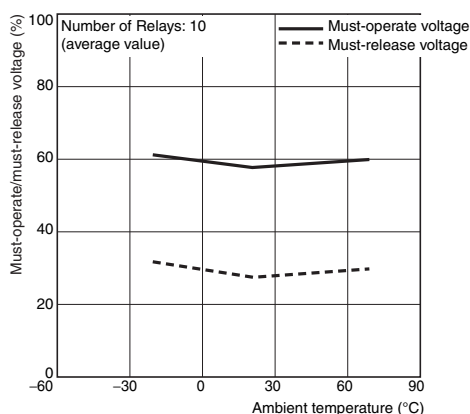

MY4□□-□□-GS-R AC Models

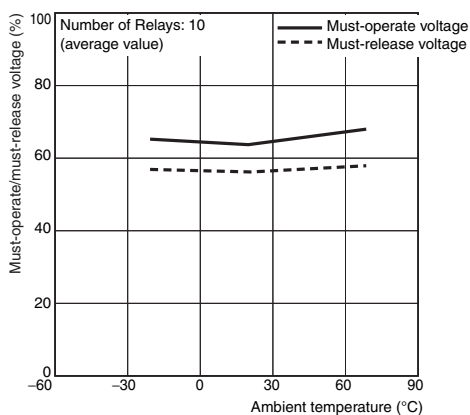

MY4□□-□□-GS-R DC Models

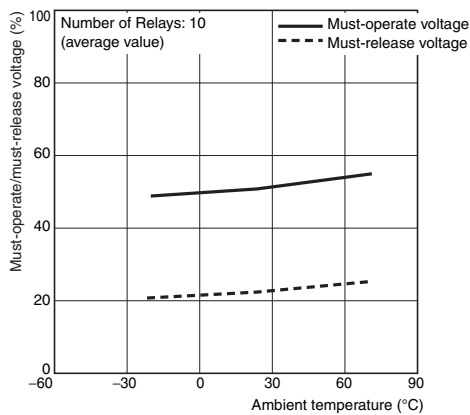

Ambient Temperature vs. Coil Temperature Rise

MY2□□-□□-GS-R AC Models, 50 Hz

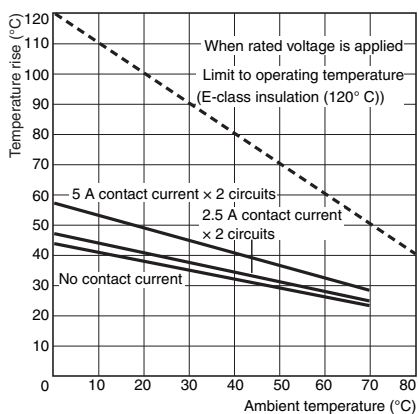

MY2□□-□□-GS-R DC Models

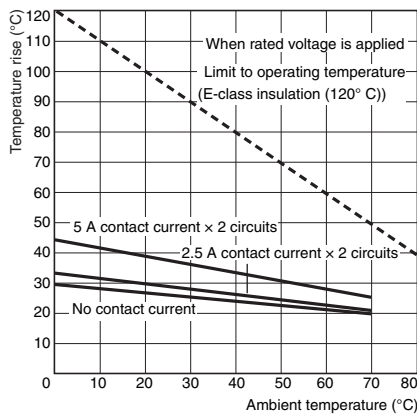

MY4□□-□□-GS-R AC Models, 50 Hz

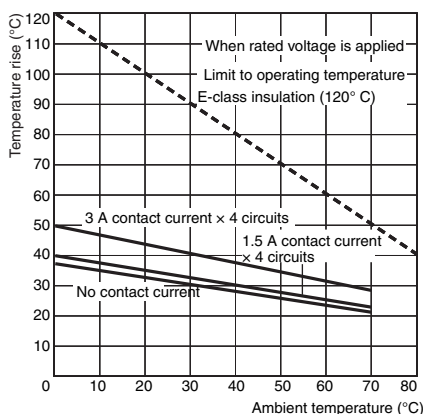

MY4□□-□□-GS-R DC Models

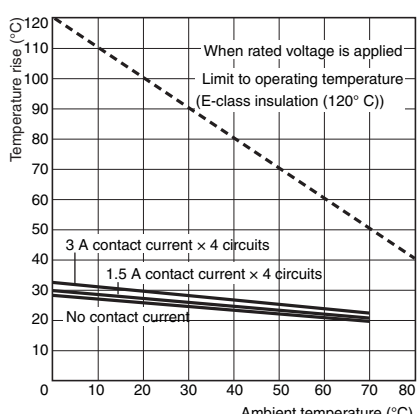

MY-GS-R

MY(S)

MYK

MYQ-MYH

Common Options (Order Separately)

Common Precautions

# MY-GS-R

## Dimensions

(Unit: mm)

### Relays

MY2-GS-R  
MY2N-GS-R  
MY2N-D2-GS-R  
MY2N-CR-GS-R

MY2IN-GS-R  
MY2IN-D2-GS-R  
MY2IN-CR-GS-R

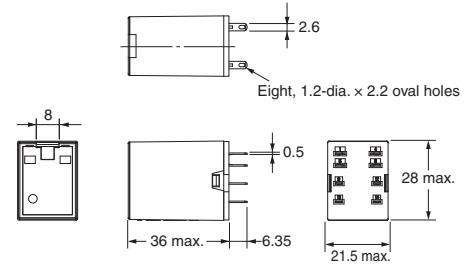
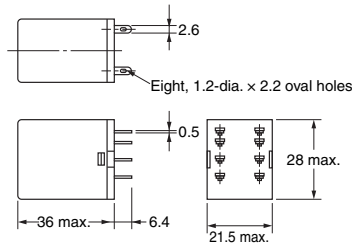

Terminal Arrangement/Internal Connections (Bottom View)

MY2-GS-R	MY2□N-GS-R			MY2□N-D2-GS-R		MY2□N-CR-GS-R
Standard Models	AC Models	DC Models (except 220 VDC)	DC Models (for 220 VDC)	DC Models (except 220 VDC)	DC Models (for 220 VDC)	AC Models
(The coil has no polarity.)	(The coil has no polarity.)	(The coil has no polarity.)	(The coil has no polarity.)	(The coil has polarity.)	(The coil has polarity.)	(The coil has no polarity.)

- Note:**
1. An AC model has coil disconnection self-diagnosis.
  2. For models with built-in diodes for coil surge absorption, check the coil polarity when wiring and wire all connections correctly.
  3. The indicator is red for AC and green for DC.
  4. The LED operation indicators indicate the energization of the coil and do not necessarily represent contact operation.

MY4-GS-R  
MY4N-GS-R  
MY4N-D2-GS-R  
MY4N-CR-GS-R

MY4IN-GS-R  
MY4IN-D2-GS-R  
MY4IN-CR-GS-R

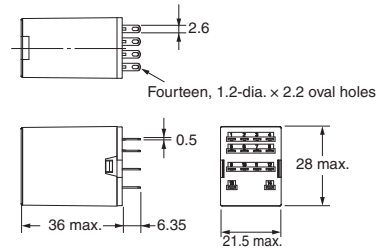
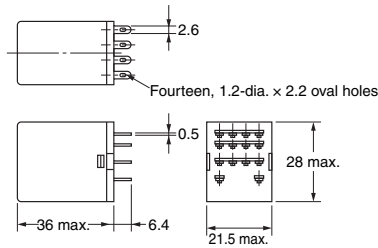

Terminal Arrangement/Internal Connections (Bottom View)

MY4-GS-R	MY4□N-GS-R			MY4□N-D2-GS-R		MY4□N-CR-GS-R
Standard Models	AC Models	DC Models (except 220 VDC)	DC Models (for 220 VDC)	DC Models (except 220 VDC)	DC Models (for 220 VDC)	DC Models
(The coil has no polarity.)	(The coil has no polarity.)	(The coil has no polarity.)	(The coil has no polarity.)	(The coil has polarity.)	(The coil has polarity.)	(The coil has no polarity.)

- Note:**
1. An AC model has coil disconnection self-diagnosis.
  2. For models with built-in diodes for coil surge absorption, check the coil polarity when wiring and wire all connections correctly.
  3. The indicator is red for AC and green for DC.
  4. The LED operation indicators indicate the energization of the coil and do not necessarily represent contact operation.

MY-GS-R

MY(S)

MYK

MYQ-MYH

Common Options (Order Separately)

Common Precautions

## Best-selling, general-purpose relays

- AC/DC coil voltage specifications can now be more easily distinguished thanks to the use of color-coded coil tape and operation indicators (LED).
- Latching levers convenient for circuit checking and MY(S) models equipped with mechanical operation indicators and operation indicators for monitoring operation status are available.
- Contact materials and contact structures can be selected based on contact reliability and corrosion resistance.

\*Voltage is printed on white tape in the case of the Standard 3-pole model (MY3).

 Refer to *Safety Precautions* on pages 62 to 63 and *Safety Precautions for All Relays*.



Refer to the standards certifications and compliance section of your OMRON website for the latest information on certified models.

## Features

### 1. More easily distinguished AC/DC coil voltage specifications

- Distinguished using color-coded coil tape\*
- Distinguished using color-coded operation indicators (LED)

\* Voltage is printed on white tape in the case of the Standard 3-pole model (MY3).

Example: MY2



Coil tape  
Pink = AC voltage AC coil specification

Example: MY4



Coil tape  
Blue = DC voltage DC coil specification

Example: MY4



Operation indicator (LED)  
Red = AC voltage AC coil specification

Example: MY4



Operation indicator (LED)  
Green = DC voltage DC coil specification

### 2. Latching levers convenient for circuit checking and MY(S) models equipped with mechanical operation indicators and operation indicators for monitoring operation status are available.

- Latching lever operating procedure
- Mechanical operation indicator/LED operation indicator

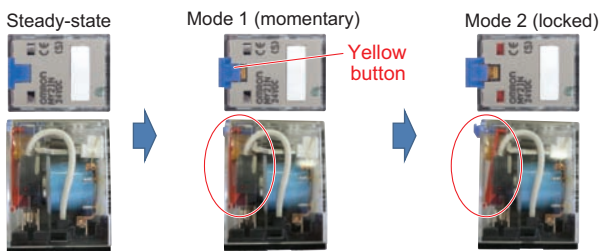

Sliding the lever to the first stage and pressing the yellow button using an insulated flat-blade screwdriver, etc., will operate the contacts.

Sliding the lever to the second stage will lock the contacts in the operating position.



Mechanical operation indicator (two locations on left and right) Contacts ON (coil energization)

LED operation indicator  
AC coil specification: Red  
DC coil specification: Green



AC coil specification (LED: Red)

### 3. Contact materials and contact structures can be selected based on contact reliability and corrosion resistance.

Contact reliability			Corrosion resistance		
	Contact structure		Contact material	Typical model	
High ↑	Crossbar bifurcated contacts 	High ↑	Au cladding + AgPd	MY4Z-CBG	
	Bifurcated contacts 		Au cladding + Ag alloy Au plating + Ag alloy	MY4Z MY2Z	
Low ↓	Single contacts 	Low ↓	Au cladding + Ag alloy	MY4	
			Ag alloy	MY2	

MY-GS-R

MY(S)

MYK

MYQ-MYH

Common Options (Order Separately)

Common Precautions

# MY(S)

## Model Number Structure

### Model Number Legend

#### ● Plug-in Terminals

##### Standard models

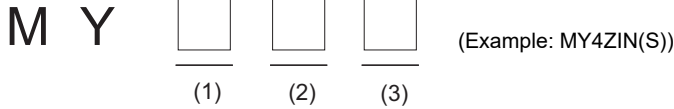

##### (1) Number of poles

- 2: 2-pole
- 3: 3-pole
- 4: 4-pole

##### (2) Contacts

- None: Single
- Z: Bifurcated
- Z-CBG: Crossbar bifurcated

##### (3) Options

- None, (S): None
- N, N(S): With operation indicator (A2/14: +)
- N1(S): With operation indicator (A1/13: +)
- IN(S): With operation indicator/latching lever (A2/14: +)
- IN1(S): With operation indicator/latching lever (A1/13: +)

#### Models with built-in diode for coil surge absorption

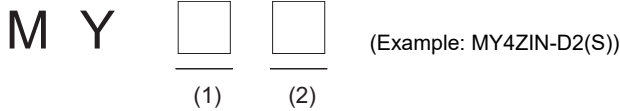

##### (1) Number of poles/contacts

- 2: 2-pole, single contacts
- 2Z: 2-pole, bifurcated contacts
- 3: 3-pole, single contacts
- 4: 4-pole, single contacts
- 4Z: 4-pole, bifurcated contacts

##### (2) Options

- N-D2, N-D2(S): Built-in diode for coil surge absorption, with operation indicator (A2/14: +)
- N1-D2(S): Built-in diode for coil surge absorption, with operation indicator (A1/13: +)
- IN-D2(S): Built-in diode for coil surge absorption, with operation indicator/latching lever (A2/14: +)
- IN1-D2(S): Built-in diode for coil surge absorption, with operation indicator/latching lever (A1/13: +)

#### Models with built-in CR circuit for coil surge absorption

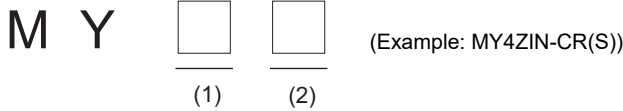

##### (1) Number of poles/contacts

- 2: 2-pole, single contacts
- 2Z: 2-pole, bifurcated contacts
- 4: 4-pole, single contacts
- 4Z: 4-pole, bifurcated contacts

##### (2) Options

- N-CR, N-CR(S): Built-in CR circuit for coil surge absorption, with operation indicator
- IN-CR(S): Built-in CR circuit for coil surge absorption, with operation indicator/latching lever

#### ● PCB terminals/case surface mounted

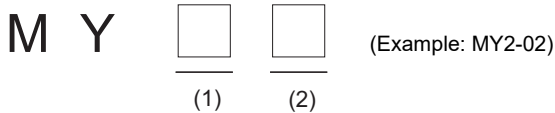

##### (1) Number of poles/contacts

- 2: 2-pole, single contacts
- 3: 3-pole, single contacts
- 4: 4-pole, single contacts
- 4Z: 4-pole, bifurcated contacts

##### (2) Terminals

- 02: PCB terminals
- F: Case-surface mounting

MY-GS-R

MY(S)

MYK

MYQ-MYH

Common Options (Order Separately)

Common Precautions

# Ordering Information



When your order, specify the rated voltage.

## ● Plug-in Terminals

Without operation indicator

Classification	Number of poles	Contacts	Model	Rated voltage
Standard models	2	Single	MY2(S)	6, 12, 24, 48/50, 110/120, 220/240 VAC 6, 12, 24, 48, 100/110 VDC
		Bifurcated	MY2Z	12, 24, 110/120, 220/240 VAC 12, 24, 100/110 VDC
	3	Single	MY3	12, 24, 110/120, 220/240 VAC 12, 24, 48, 100/110 VDC
		4	Single	MY4(S)
	Bifurcated		MY4Z(S)	6, 12, 24, 48/50, 110/120, 220/240 VAC 6, 12, 24, 48, 100/110 VDC
	Crossbar bifurcated		MY4Z-CBG	100/110, 110/120, 200/220 VAC 12, 24, 48, 100/110 VDC

With operation indicator

Classification	Number of poles	Contacts	Model	Rated voltage	
Standard models	2	Single	Type 1	MY2N(S)	6, 12, 24, 48/50, 110/120, 220/240 VAC 6, 12, 24, 48, 100/110 VDC
			Type 2	MY2N1(S)	6, 12, 24, 48, 100/110 VDC
		Bifurcated	MY2ZN	110/120, 220/240 VAC 24 VDC	
	3	Single	MY3N	24, 110/120, 220/240 VAC 12, 24, 48, 100/110 VDC	
		4	Single	Type 1	MY4N(S)
	Type 2			MY4N1(S)	6, 12, 24, 48, 100/110 VDC
	Bifurcated		Type 1	MY4ZN(S)	6, 12, 24, 48/50, 110/120, 220/240 VAC 6, 12, 24, 48, 100/110 VDC
			Type 2	MY4ZN1(S)	6, 12, 24, 48, 100/110 VDC
	Crossbar bifurcated		MY4ZN-CBG	100/110, 200/220 VAC 24 VDC	
	Models with built-in diode for coil surge absorption		2	Single	MY2N-D2(S)
		Bifurcated		MY2ZN-D2	24 VDC
		3	Single	MY3N-D2	12, 24, 48 VDC
4			Single	MY4N-D2(S)	6, 12, 24, 48, 100/110 VDC
		Bifurcated	MY4ZN-D2(S)	6, 12, 24, 48, 100/110 VDC	
Type 1 		2	Single	MY2N1-D2(S)	6, 12, 24, 48, 100/110 VDC
	4	Single	MY4N1-D2(S)	6, 12, 24, 48, 100/110 VDC	
		Bifurcated	MY4ZN1-D2(S)	6, 12, 24, 48, 100/110 VDC	
Type 2 	2	Single	MY2N-CR(S)	110/120, 220/240 VAC	
	4	Single	MY4N-CR(S)	110/120, 220/240 VAC	
		Bifurcated	MY4ZN-CR(S)	110/120, 220/240 VAC	

MY-GS-R

MY(S)

MYK

MYQ-MYH

Common Options (Order Separately)

Common Precautions

# MY(S)

MY-GS-R

## With operation indicator/latching lever

Classification		Number of poles	Contacts	Model	Rated voltage
Standard models	2	Single	Type 1	MY2IN(S)	6, 12, 24, 48/50, 110/120, 220/240 VAC 6, 12, 24, 48, 100/110 VDC
			Type 2	MY2IN1(S)	6, 12, 24, 48, 100/110 VDC
	4	Single	Type 1	MY4IN(S)	6, 12, 24, 48/50, 110/120, 220/240 VAC 6, 12, 24, 48, 100/110 VDC
			Type 2	MY4IN1(S)	6, 12, 24, 48, 100/110 VDC
		Bifurcated	Type 1	MY4ZIN(S)	6, 12, 24, 48/50, 110/120, 220/240 VAC 6, 12, 24, 48, 100/110 VDC
			Type 2	MY4ZIN1(S)	6, 12, 24, 48, 100/110 VDC
Models with built-in diode for coil surge absorption	Type 1	2	Single	MY2IN-D2(S)	6, 12, 24, 48, 100/110 VDC
	Type 1	4	Single	MY4IN-D2(S)	6, 12, 24, 48, 100/110 VDC
			Bifurcated	MY4ZIN-D2(S)	6, 12, 24, 48, 100/110 VDC
	Type 2	2	Single	MY2IN1-D2(S)	6, 12, 24, 48, 100/110 VDC
			4	Single	MY4IN1-D2(S)
	Bifurcated	MY4ZIN1-D2(S)		6, 12, 24, 48, 100/110 VDC	
Models with built-in CR circuit for coil surge absorption	2	Single		MY2IN-CR(S)	110/120, 220/240 VAC
				MY4IN-CR(S)	110/120, 220/240 VAC
	4	Bifurcated	MY4ZIN-CR(S)	110/120, 220/240 VAC	

MY(S)

MYK

## ●PCB terminals

Classification		Number of poles	Contacts	Model	Rated voltage
Standard models (compliant with Electrical Appliances and Material Safety Act)	2	Single		MY2-02	12, 24, 100/110, 110/120, 200/220, 220/240 VAC 12, 24, 48, 100/110 VDC
			3	Single	MY3-02
	4	Single		MY4-02	12, 24, 100/110, 110/120, 200/220, 220/240 VAC 12, 24, 48, 100/110 VDC
			Bifurcated	MY4Z-02	100/110, 110/120, 200/220 VAC 12, 24, 48, 100/110 VDC

MYQ-MYH

## ●Case-surface mounting

Classification		Number of poles	Contacts	Model	Rated voltage
Standard models (compliant with Electrical Appliances and Material Safety Act)	2	Single		MY2F	24, 100/110, 110/120, 200/220, 220/240 VAC 12, 24, 48, 100/110 VDC
			3	Single	MY3F
	4	Single		MY4F	24, 100/110, 110/120, 200/220 VAC 12, 24, 48, 100/110 VDC
			Bifurcated	MY4ZF	200/220 VAC 12, 24 VDC

Common Options (Order Separately)

Common Precautions



# Ratings and Specifications

## Ratings Operating Coils

Terminal Type	Classification	Number of poles	Contacts	Without operation indicator	With operation indicator	With latching lever
Plug-in terminals	Standard models	2	Single	MY2(S)	MY2N(S), MY2N1(S)	MY2IN(S), MY2IN1(S)
		4	Single	MY4(S)	MY4N(S), MY4N1(S)	MY4IN(S), MY4IN1(S)
			Bifurcated	MY4Z(S)	MY4ZN(S), MY4ZN1(S)	MY4ZIN(S), MY4ZIN1(S)
	Models with built-in diode for coil surge absorption	2	Single		MY2N-D2(S), MY2N1-D2(S)	MY2IN-D2(S), MY2IN1-D2(S)
		4	Single		MY4N-D2(S), MY4N1-D2(S)	MY4IN-D2(S), MY4IN1-D2(S)
			Bifurcated		MY4ZN-D2(S), MY4ZN1-D2(S)	MY4ZIN-D2(S), MY4ZIN1-D2(S)
	Models with built-in CR circuit for coil surge absorption	2	Single		MY2N-CR(S)	MY2IN-CR(S)
		4	Single		MY4N-CR(S)	MY4IN-CR(S)
			Bifurcated		MY4ZN-CR(S)	MY4ZIN-CR(S)

Item	Rated current (mA)		Coil resistance (Ω)	Coil inductance (H)		Must operate voltage (V)	Must release voltage (V)	Maximum voltage (V)	Power consumption (VA, W)
	Rated voltage (V)	50 Hz		60 Hz	Armature OFF				
AC	6	214.1	183	12.2	0.04	0.08	30% min.*2	110% of rated voltage	Approx. 0.9 to 1.3 (at 60 Hz)
	12	106.5	91	46	0.17	0.33			
	24	53.8	46	180	0.69	1.30			
	48/50	24.7/25.7	21.1/22.0	788	3.22	5.66			
	110/120	9.9/10.8	8.4/9.2	4,430	19.20	32.1			
	220/240	4.8/5.3	4.2/4.6	18,790	83.50	136.4			
DC	6	151		39.8	0.17	0.33	10% min.*2	110% of rated voltage	Approx. 0.9
	12	75		160	0.73	1.37			
	24	37.7		636	3.20	5.72			
	48	18.8		2,560	10.60	21.0			
	100/110	9.0/9.9		11,100	45.60	86.2			

- Note:**
- The rated current and coil resistance are measured at a coil temperature of 23°C with tolerances of +15%/-20% for AC rated current and ±15% for DC coil resistance.
  - The AC coil resistance and inductance values are reference values only (at 60 Hz).
  - Operating characteristics were measured at a coil temperature of 23°C.
  - The maximum voltage capacity was measured at an ambient temperature of 23°C.
  - Power consumption drop was measured for the above data. When driving transistors, check leakage current and connect a bleeder resistor if required.

- \*1. There is variation between products, but actual values are 80% maximum.  
To ensure operation, apply at least 80% of the rated value (at a coil temperature of 23°C).
- \*2. There is variation between products, but actual values are 30% minimum for AC and 10% minimum for DC. To ensure release, use a value that is lower than the specified value.

MY-GS-R

MY(S)

MYK

MYQ-MYH

Common Options (Order Separately)

Common Precautions

# MY(S)

MY-GS-R

Terminal Type	Classification	Number of poles	Contacts	Without operation indicator	With operation indicator
Plug-in terminals	Standard models	2	Bifurcated	MY2Z	MY2ZN
		3	Single	MY3	MY3N
		4	Crossbar bifurcated	MY4Z-CBG	MY4ZN-CBG
	Models with built-in diode for coil surge absorption	2	Bifurcated		MY2ZN-D2
		3	Single		MY3N-D2
PCB terminals	Standard models	2	Single	MY2-02	
		3	Single	MY3-02	
		4	Single	MY4-02	
			Bifurcated	MY4Z-02	
		Case-surface mounting	Standard models	2	Single
3	Single			MY3F	
4	Single			MY4F	
	Bifurcated			MY4ZF	

MY(S)

Rated voltage (V)	Item	Rated current (mA)		Coil resistance (Ω)	Coil inductance (H)		Must operate voltage (V)	Must release voltage (V)	Maximum voltage (V)	Power consumption (VA, W)
		50 Hz	60 Hz		Armature OFF	Armature ON				
AC	12	106.5	91	46	0.17	0.33	80% max.*1	30% min.*2	110% of rated voltage	Approx. 0.9 to 1.3 (at 60 Hz)
	24	53.8	46	180	0.69	1.3				
	100/110	11.7/12.9	10/11	3,750	14.54	24.6				
	110/120	9.9/10.8	8.4/9.2	4,430	19.2	32.1				
	200/220	6.2/6.8	5.3/5.8	12,950	54.75	94.07				
DC	12	75		160	0.73	1.37	10% min.*2			Approx. 0.9
	24	36.9		650	3.2	5.72				
	48	18.5		2,600	10.6	21.0				
	100/110	9.1/10		11,000	45.6	86.2				

MYK

- Note:**
- The rated current and coil resistance are measured at a coil temperature of 23°C with tolerances of +15%/-20% for AC rated current and ±15% for DC coil resistance.
  - The AC coil resistance and inductance values are reference values only (at 60 Hz).
  - Operating characteristics were measured at a coil temperature of 23°C.
  - The maximum voltage capacity was measured at an ambient temperature of 23°C.

- \*1. There is variation between products, but actual values are 80% maximum. To ensure operation, apply at least 80% of the rated value.  
 \*2. There is variation between products, but actual values are 30% minimum for AC and 10% minimum for DC. To ensure release, use a value that is lower than the specified value.

MYQ-MYH

Common Options (Order Separately)

Common Precautions

**Contact Ratings**

Number of poles (contact configuration) Contact structure Load	2-pole (DPDT)				3-pole (3PDT)	
	Single		Bifurcated		Single	
	Resistive load	Inductive load (cos φ = 0.4, L/R = 7 ms)	Resistive load	Inductive load (cos φ = 0.4, L/R = 7 ms)	Resistive load	Inductive load (cos φ = 0.4, L/R = 7 ms)
<b>Rated load</b>	5 A at 250 VAC 5 A at 30 VDC	2 A at 250 VAC 2 A at 30 VDC	5 A at 220 VAC 5 A at 24 VDC	2 A at 220 VAC 2 A at 24 VDC	5 A at 220 VAC 5 A at 24 VDC	2 A at 220 VAC 2 A at 24 VDC
<b>Rated carry current*1</b>	10 A		5 A		5 A	
<b>Maximum switching voltage</b>	250 VAC, 125 VDC				250 VAC, 125 VDC	
<b>Maximum switching current</b>	10 A		5 A		5 A	
<b>Maximum switching power</b>	2,500 VA 300 W	500 VA 60 W	1,100 VA 120 W	440 VA 48 W	1,100 VA 120 W	440 VA 48 W
<b>Contact material</b>	Ag		Au plating + Ag		Ag	

Number of poles (contact configuration) Contact structure Load	4-pole (4PDT)					
	Single		Bifurcated		Crossbar bifurcated (CBG)	
	Resistive load	Inductive load (cos φ = 0.4, L/R = 7 ms)	Resistive load	Inductive load (cos φ = 0.4, L/R = 7 ms)	Resistive load	Inductive load (cos φ = 0.4, L/R = 7 ms)
<b>Rated load</b>	3 A at 250 VAC 3 A at 30 VDC	0.8 A at 250 VAC 1.5 A at 30 VDC	3 A at 250 VAC 3 A at 30 VDC	0.8 A at 250 VAC 1.5 A at 30 VDC	1 A at 220 VAC 1 A at 24 VDC	0.3 A at 220 VAC 0.5 A at 24 VDC
<b>Rated carry current*1</b>	5 A				1 A	
<b>Maximum switching voltage</b>	250 VAC, 125 VDC					
<b>Maximum switching current</b>	5 A				1 A	
<b>Maximum switching power</b>	1,250 VA 150 W	200 VA 45 W	1,250 VA 150 W	200 VA 45 W	220 VA 24 W	66 VA 12 W
<b>Contact material</b>	Au cladding + Ag alloy				Au cladding + AgPd	

\*1. If you use a Socket, do not exceed the rated carry current of the Socket.

MY-GS-R

MY(S)

MYK

MYQ-MYH

Common Options (Order Separately)

Common Precautions

Characteristics

Number of poles (contact configuration)	2-pole (DPDT)		3-pole (3PDT)		4-pole (4PDT)		
	Single	Bifurcated	Single	Single	Bifurcated	Crossbar bifurcated (CBG)	
Contact resistance*1 *2	100 mΩ max.	50 mΩ max.	50 mΩ max.	100 mΩ max.	100 mΩ max.	100 mΩ max.	
Operate time*3	20 ms max.						
Release time*3	20 ms max.						
Maximum switching frequency	Mechanical	18,000 operations/h					
	Rated load	1,800 operations/h					
Insulation resistance*4	100 MΩ min.						
Dielectric strength	Between coil and contacts	2,000 VAC, 50/60 Hz for 1 min					700 VAC at 50/60 Hz for 1 min
	Between contacts of different polarity						
	Between contacts of the same polarity	1,000 VAC at 50/60 Hz for 1 min					
Vibration resistance	Destruction	10 to 55 to 10 Hz, 0.5-mm single amplitude (1.0-mm double amplitude)					
	Malfunction	10 to 55 to 10 Hz, 0.5-mm single amplitude (1.0-mm double amplitude)					
Shock resistance	Destruction	1,000 m/s <sup>2</sup>					
	Malfunction	200 m/s <sup>2</sup>					
Endurance	Mechanical	AC: 50,000,000 operations min. DC: 100,000,000 operations min. (switching frequency: 18,000 operations/h)	AC: 50,000,000 operations min. DC: 50,000,000 operations min. (switching frequency: 18,000 operations/h)	AC: 50,000,000 operations min. DC: 100,000,000 operations min. (switching frequency: 18,000 operations/h)	AC: 50,000,000 operations min. DC: 100,000,000 operations min. (switching frequency: 18,000 operations/h)	AC: 20,000,000 operations min. DC: 20,000,000 operations min. (switching frequency: 18,000 operations/h)	AC: 5,000,000 operations min. DC: 5,000,000 operations min. (switching frequency: 18,000 operations/h)
	Electrical*5	500,000 operations min. (rated load, switching frequency: 1,800 operations/h)	200,000 operations min. (rated load, switching frequency: 1,800 operations/h)	500,000 operations min. (rated load, switching frequency: 1,800 operations/h)	200,000 operations min. (rated load, switching frequency: 1,800 operations/h)	100,000 operations min. (rated load, switching frequency: 1,800 operations/h)	50,000 operations min. (rated load, switching frequency: 1,800 operations/h)
Failure rate P value (reference value)*6	1 mA at 5 VDC	100 μA at 1 VDC	1 mA at 5 VDC	1 mA at 1 VDC	100 μA at 1 VDC	100 μA at 1 VDC	
Weight	Approx. 35 g	Approx. 35 g	Approx. 35 g	Approx. 35 g	Approx. 35 g	Approx. 35 g	

Note: The data shown above are initial values.

\*1. Models with latching lever are 100 mΩ maximum.

\*2. Measurement conditions: 1 A at 5 VDC using the voltage drop method.

\*3. Measurement conditions: With rated operating power applied, not including contact bounce.

\*4. Measurement conditions: For 500 VDC applied to the same location as for dielectric strength measurement.

\*5. Ambient temperature condition: 23°C

\*6. This value was measured at a switching frequency of 120 operations per minute.

Number of poles (contact configuration)	2-pole (DPDT)				3-pole (3PDT)		4-pole (4PDT)			
	Single		Bifurcated		Single		Single/bifurcated		Crossbar bifurcated (CBG)	
Contact structure	Without operation indicator	With operation indicator	Without operation indicator	With operation indicator	Without operation indicator	With operation indicator	Without operation indicator	With operation indicator	Without operation indicator	With operation indicator
Operation indicator										
Ambient operating temperature*1	-55 to +70%		-55 to +70%	-55 to +60%*2	-55 to +70%	-55 to +60% *2	-55 to +70%		-55 to +70%	-55 to +60%
Ambient operating humidity	5 to 85%RH									

\*1. With no icing or condensation.

\*2. This limitation is due to the diode junction temperature and elements used.

MY-GS-R

MY(S)

MYK

MYQ-MYH

Common Options (Order Separately)

Common Precautions

**Certified Standards**

●UL certification (File No. E41515)

Model	Standard number	Category	Listed/ Recognized	Operating Coil ratings	No. of poles	Contact ratings	Certified number of operations
MY2□(S) MY2□-D2(S) MY2□-CR(S)	UL508	NRNT2	Recognition	6 to 240 VAC 6 to 125 VDC	2	10 A, 250 VAC (General Use) 10 A, 30 VDC (General Use) 7 A, 240 VAC (General Use) 7 A, 24 VDC (Resistive) 5 A, 240 VAC (General Use) 5 A, 250 VAC (Resistive) 5 A, 30 VDC (Resistive) 3 A, 265 VAC (Resistive)	6,000
						1/6 HP, 250 VAC 1/8 HP, 265 VAC 1/10 HP, 120 VAC	1,000
						B300 Pilot Duty (Same polarity)	6,000
MY2Z□ MY2-02 MY2F	UL508	NRNT2	Recognition	6 to 240 VAC 6 to 125 VDC	2	7 A, 240 VAC (General Use) 7 A, 24 VDC (Resistive) 5 A, 240 VAC (General Use) 5 A, 250 VAC (Resistive) 5 A, 30 VDC (Resistive) 3 A, 265 VAC (Resistive)	6,000
						1/6 HP, 250 VAC 1/8 HP, 265 VAC 1/10 HP, 120 VAC	1,000
						B300 Pilot Duty (Same polarity)	6,000
MY3□ MY3N-D2 MY3-02 MY3F	UL508	NRNT2	Recognition	6 to 240 VAC 6 to 125 VDC	3	5 A, 28 VDC (Resistive) 5 A, 240 VAC (General Use)	6,000
						1/6 HP, 250 VAC	1,000
MY4□(S) MY4□-D2(S) MY4□-CR(S) MY4□-02 MY4□F	UL508	NRNT2	Recognition	6 to 240 VAC 6 to 125 VDC	4	5 A, 28 VDC (General Use) (Same polarity) 5 A, 240 VAC (General Use) (Same polarity) 5 A, 30 VDC (Resistive) (Same polarity) 5 A, 250 VAC (Resistive) (Same polarity) 0.2 A, 120 VDC (Resistive) (Same polarity)	6,000
						1/6 HP, 250 VAC (Same polarity) 1/10 HP, 120 VAC (Same polarity)	1,000
						B300 Pilot Duty (Same polarity)	6,000

MY-GS-R

MY(S)

MYK

MYQ-MYH

Common Options (Order Separately)

Common Precautions

# MY(S)

MY-GS-R

MY(S)

MYK

MYQ-MYH

Common Options (Order Separately)

Common Precautions

## ● CSA certification (File No. LR31928)

Model	Standard number	Class number	Operating Coil ratings	No. of poles	Contact ratings	Certified number of operations
MY2□(S) MY2□-D2(S) MY2□-CR(S)	C22.2 NO.0, No.14		6 to 240 VAC 6 to 125 VDC	2	7 A, 240 VAC (Resistive) 7 A, 24 VDC (Resistive) 5 A, 240 VAC (General Use) 5 A, 250 VAC (Resistive) 5 A, 30 VDC (Resistive)	6,000
					1/6 HP, 250 VAC (Same polarity) 1/10 HP, 120 VAC (Same polarity)	1,000
MY2Z□ MY2-02 MY2F	C22.2 NO.0, No.14		6 to 240 VAC 6 to 125 VDC	2	7 A, 240 VAC (General Use) (Same polarity) 7 A, 24 VDC (Resistive) (Same polarity) 5 A, 240 VAC (General Use) (Same polarity) 5 A, 30 VDC (Resistive) 5 A, 250 VAC (Resistive) (Same polarity) 0.2 A, 120 VDC (Resistive)	6,000
					1/6 HP, 250 VAC 1/10 HP, 120 VAC	1,000
MY3□ MY3N-D2 MY3-02 MY3F	C22.2 NO.0, No.14		6 to 240 VAC 6 to 125 VDC	3	5 A, 28 VDC (Resistive) 5 A, 240 VAC (General Use) 7 A, 240 VAC (General Use) 7 A, 24 VDC (Resistive)	6,000
					1/6 HP, 250 VAC	1,000
MY4□(S) MY4□-D2(S) MY4□-CR(S)	C22.2 No.14	3211 07	6 to 240 VAC 6 to 125 VDC	4	5 A, 240 VAC (General Use) (Same polarity) 5 A, 28 VDC (General Use) (Same polarity) 5 A, 250 VAC (Resistive) (Same polarity) 5 A, 30 VDC (Resistive) (Same polarity) 0.2 A, 120 VDC (Resistive) (Same polarity)	6,000
					1/6 HP, 250 VAC (Same polarity) 1/10 HP, 120 VAC (Same polarity)	1,000
					B300 Pilot Duty (Same polarity)	6,000
MY4□-02 MY4□F	C22.2 NO.0, No.14	3211 07	6 to 240 VAC 6 to 125 VDC	4	7 A, 240 VAC (General Use) (Same polarity) 7 A, 24 VDC (Resistive) (Same polarity) 5 A, 240 VAC (General Use) (Same polarity) 5 A, 30 VDC (Resistive) 5 A, 250 VAC (Resistive) (Same polarity) 0.2 A, 120 VDC (Resistive)	6,000
					1/6 HP, 250 VAC 1/10 HP, 120 VAC	1,000

## ● TÜV Rheinland certification (Certification No. R50030059)

Model	Operating Coil ratings	Contact ratings	Certified number of operations
MY2Z□ MY2-02 MY2F	6 to 125 VDC, 6 to 240 VAC	5 A, 250 VAC (cos φ = 1.0)	100,000
MY3□ MY3N-D2 MY3-02 MY3F		5 A, 250 VAC (cos φ = 1.0) 0.8 A, 250 VAC (cos φ = 0.4)	
MY4□-02 MY4□F		3 A, 120 VAC (cos φ = 1.0) 0.8 A, 250 VAC (cos φ = 0.4)	

●CE Marking

Model	EMC Directive	Low Voltage Directive	Machinery Directive	Safety Category
MY2□□(S) MY2□□-D2(S) MY2□□-CR(S) MY2Z□ MY2ZN-D2 MY2F	Not applicable	Applicable	Not applicable	1
MY3□ MY3N-D2 MY3F				
MY4□(S) MY4□-D2(S) MY4□-CR(S) MY4□F				

●LR certification (Lloyd's Register)

Model	Environmental Category	Operating Coil ratings
MY2□(S) MY2□-D2(S) MY2□-CR(S)	ENV2,3	6 to 240 VAC 6 to 125 VDC
MY2Z□ MY2ZN-D2	ENV2,3	6 to 240 VAC 6 to 125 VDC
MY4□(S) MY4□-D2(S) MY4□-CR(S)	ENV2,3	6 to 240 VAC 6 to 125 VDC

●VDE certification

Model	Standard number	Certification No.	Operating Coil ratings	Contact ratings	Certified number of operations
MY2□(S) MY2□-D2(S) MY2□-CR(S)	EN 61810-1	112467UG	6, 12, 24, 48/50, 100/110, 110/120, 200/220, 220/240 VAC 6, 12, 24, 48, 100/110, 125 VDC	10A, 250 VAC (cos φ = 1) 10A, 30 VDC (L/R = 0 ms)	MY2: 100,000 MY4: 100,000 MY4Z: 50,000 (AC)
MY4□(S) MY4□-D2(S) MY4□-CR(S)			6, 12, 24, 48/50, 100/110, 110/120, 200/220, 220/240 VAC 6, 12, 24, 48, 100/110, 125 VDC		

MY-GS-R

MY(S)

MYK

MYQ-MYH

Common Options (Order Separately)

Common Precautions

# MY(S)

## Engineering Data (Reference Value)

### ● Maximum Switching Capacity

MY2(S)

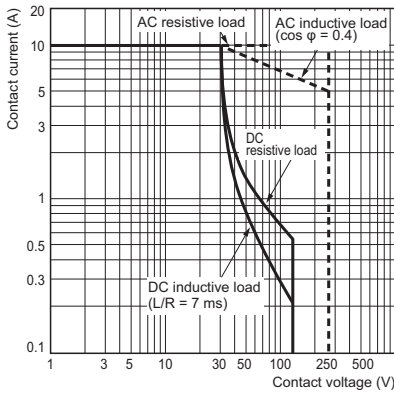

MY3

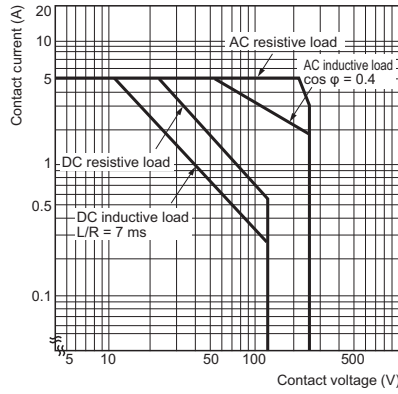

MY4(S)

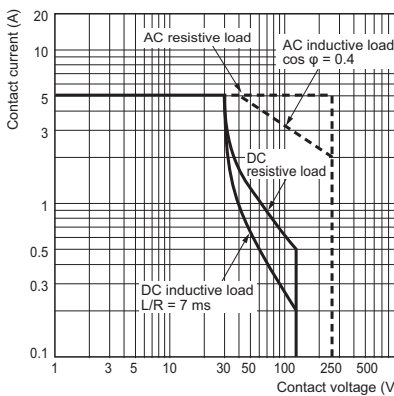

MY4Z-CBG

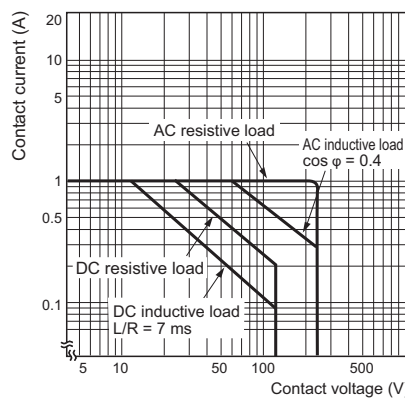

### ● Endurance Curve

MY2(S)

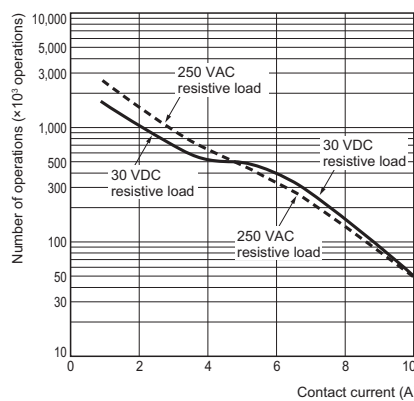

MY2(S)

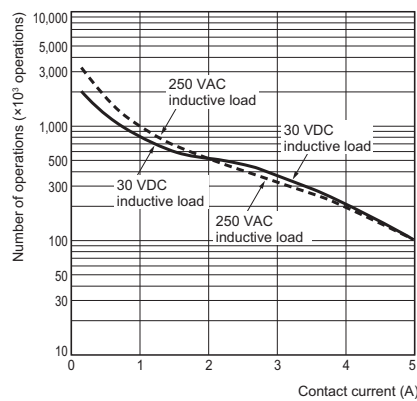

MY3

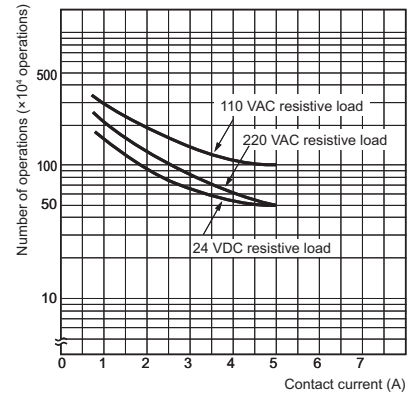

MY3

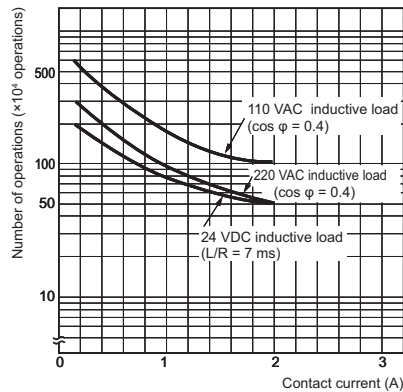

MY4(S)

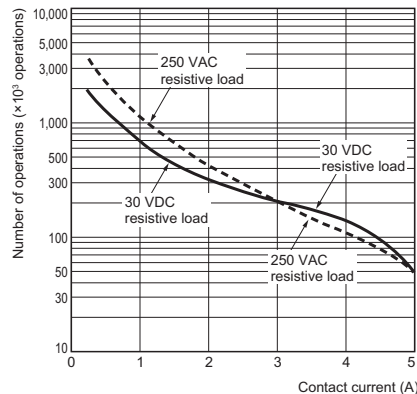

MY4(S)

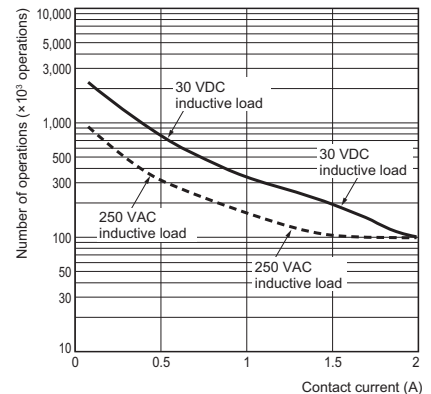

MY-GS-R

MY(S)

MYK

MYQ-MYH

Common Options (Order Separately)

Common Precautions



MY4Z(S)

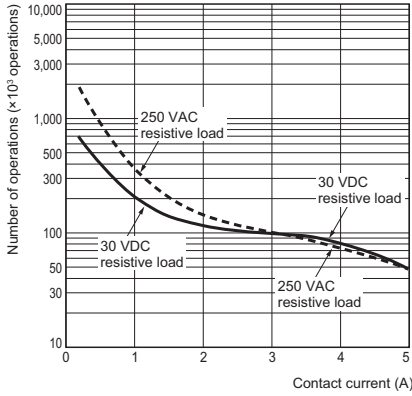

MY4Z(S)

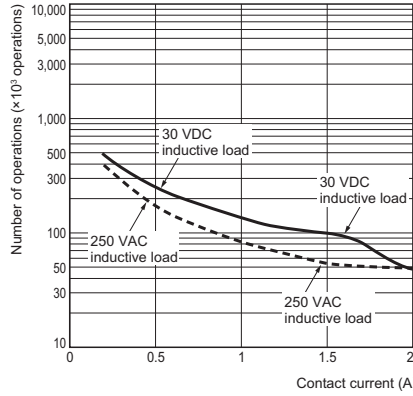

● Ambient Temperature vs. Must-operate and Must-release Voltage

MY2 AC Models

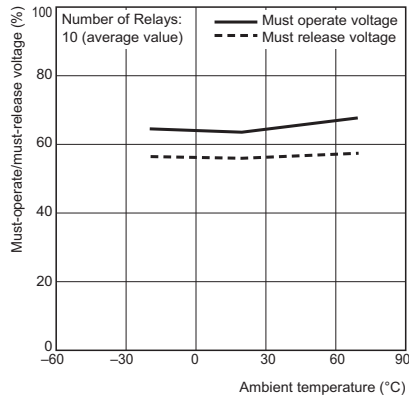

MY2 DC Models

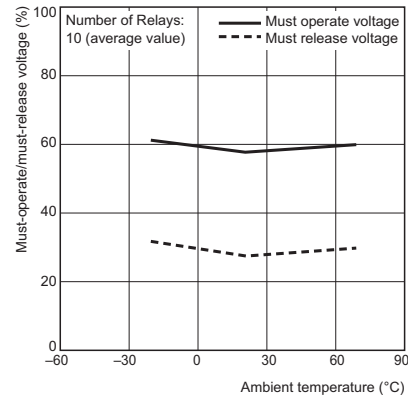

MY4 AC Models

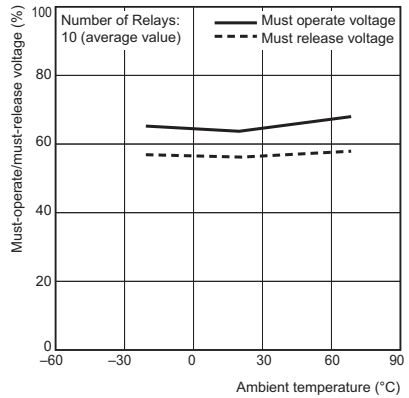

MY4 DC Models

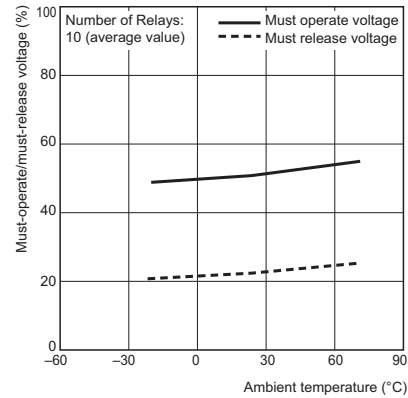

## ● Ambient Temperature vs. Coil Temperature Rise

### MY2 AC Models, 50 Hz

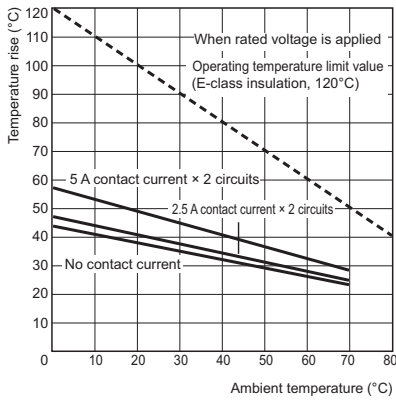

### MY2 DC Models

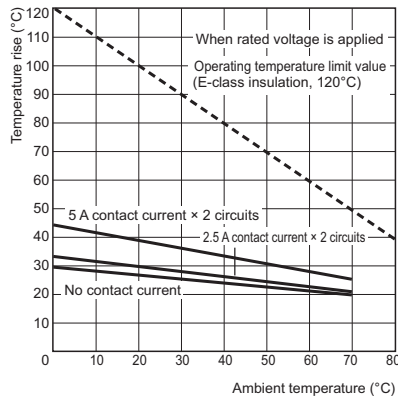

### MY4 AC Models, 50 Hz

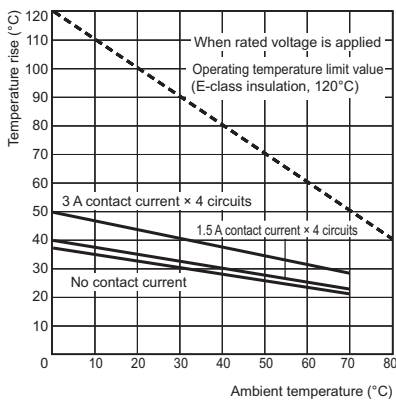

### MY4 DC Models

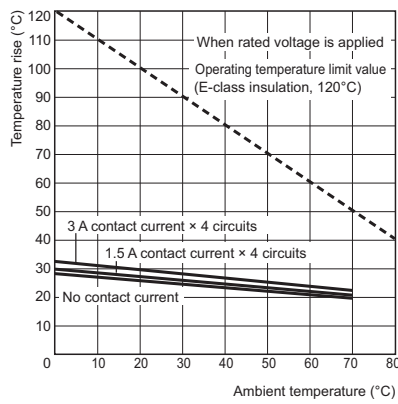

## Models with built-in diode for coil surge absorption MY□-D

### With Diode

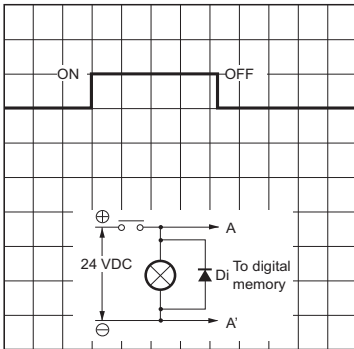

### Without Diode

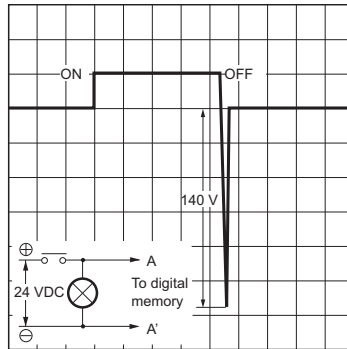

- Note:**
1. Make sure that the polarity is correct.
  2. The release time will increase, but the 20-ms specification for standard models is satisfied.
  3. Diode properties: The diode has a reversed dielectric strength of 1,000 V.  
Forward current: 1 A

**Models with built-in CR circuit for coil surge absorption MY□-CR**

**With CR**

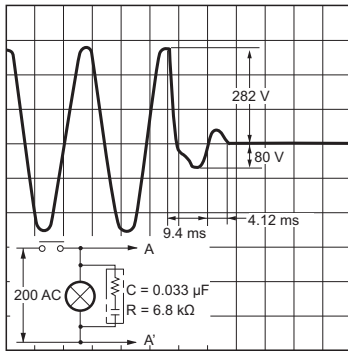

**Without CR**

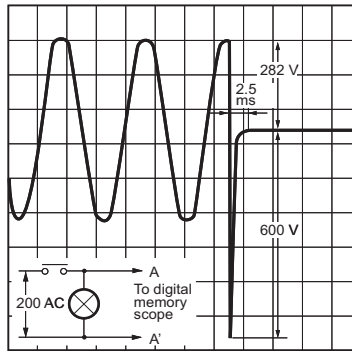

**● Contact Reliability Test MY4Z-CBG (Modified Allen Bradley Circuit)**

Contact load: 5 VDC, 1 mA resistive load

Malfunction level: Contact resistance of 100 Ω

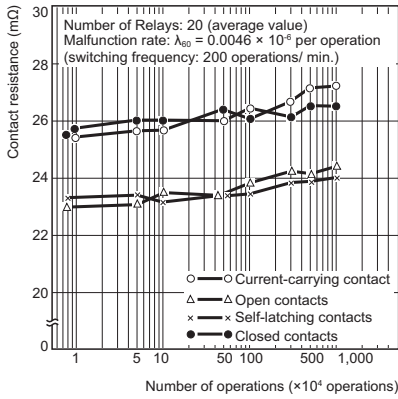

**Common Specifications for MY2, MY3, MY4, MY4Z, MY□-02, MY□F, and MY(S)**

**● Shock Malfunction**

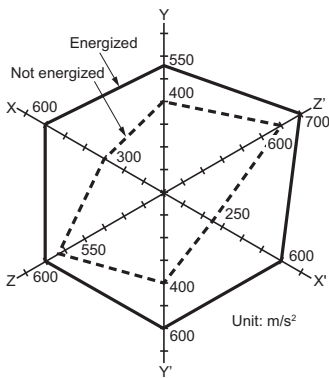

N = 20

Measurement: Shock was applied 3 times each in 6 directions along 3 axes with the Relay energized and not energized to check the shock values that cause the Relay to malfunction.

Criteria: Non-energized: 200 m/s<sup>2</sup>,  
 Energized: 200 m/s<sup>2</sup>

**Shock direction**

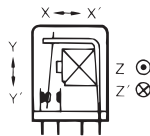

MY-GS-R

MY(S)

MYK

MYQ-MYH

Common Options (Order Separately)

Common Precautions

# MY(S)

## Dimensions

(Unit: mm)

### ● Plug-in terminals

MY2□(S)

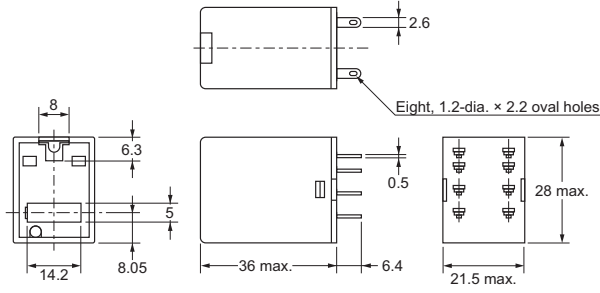

**Note:** The picture is lockable test button type.

### Terminal Arrangement/Internal Connections (Bottom View)

**MY2IN(S)**  
(AC Model)

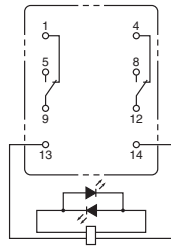

**MY2IN(S)**  
(DC Models)

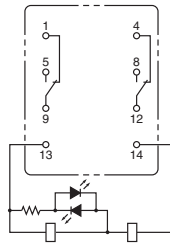

**MY2IN-D2(S)**  
(DC Models Only)

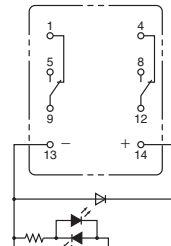

**MY2IN-CR**  
(AC Models Only)

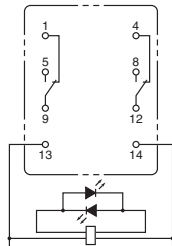

**MY2IN1(S)**  
(DC Models)

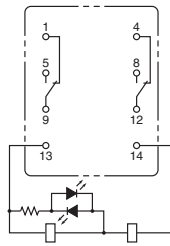

**MY2IN1-D2(S)**  
(DC Models Only)

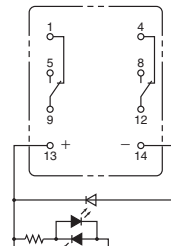

**Note:** For the DC models, check the coil polarity when wiring and wire all connections correctly.

MY-GS-R

MY(S)

MYK

MYQ-MYH

Common Options (Order Separately)

Common Precautions

**MY2Z□**  
**MY2ZN-D2**

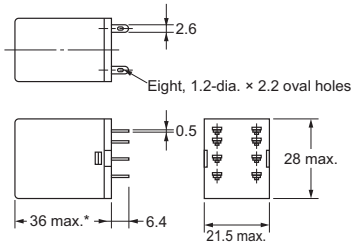
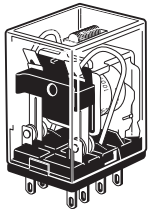

\* For the MY2Z-CR and MY2ZN-CR, this dimension is 53 mm maximum.

**Terminal Arrangement/Internal Connection Diagram (Bottom View)**

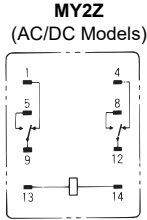

(Coil has no polarity)

**MY2ZN**

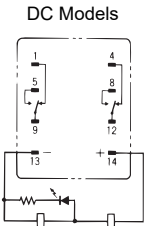

(Coil has polarity)

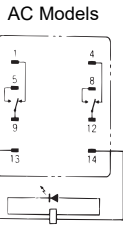

(Coil has no polarity)

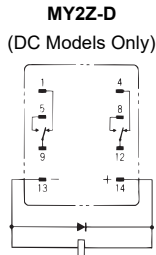

(Coil has polarity)

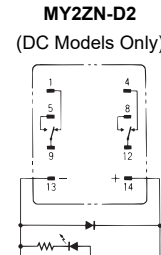

(Coil has polarity)

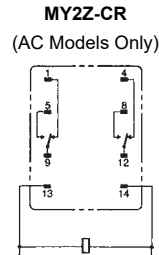

(Coil has no polarity)

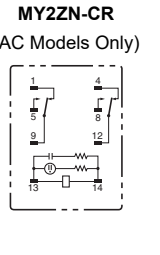

(Coil has no polarity)

- Note:**
1. An AC model has coil disconnection self-diagnosis.
  2. For the DC models, check the coil polarity when wiring and wire all connections correctly.
  3. The indicator is red for AC and green for DC.
  4. The operation indicator indicates the energization of the coil and does not represent contact operation.

**MY3□**  
**MY3N-D2**

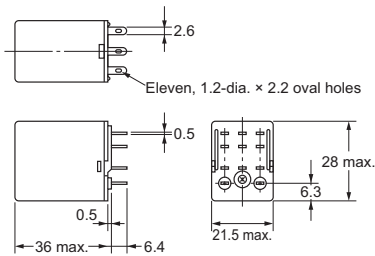
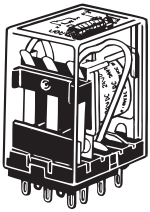

**Terminal Arrangement/Internal Connection Diagram (Bottom View)**

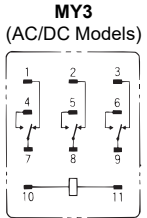

(Coil has no polarity)

**MY3N**

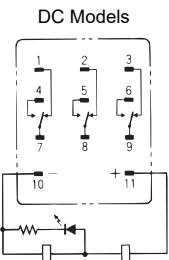

(Coil has polarity)

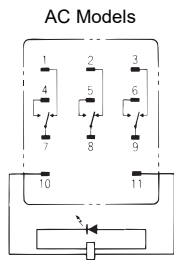

(Coil has no polarity)

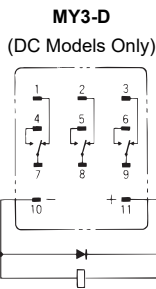

(Coil has polarity)

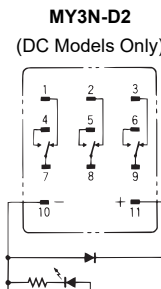

(Coil has polarity)

- Note:**
1. An AC model has coil disconnection self-diagnosis.
  2. For the DC models, check the coil polarity when wiring and wire all connections correctly.
  3. The indicator is red for AC and green for DC.
  4. The operation indicator indicates the energization of the coil and does not represent contact operation.

# MY(S)

MY-GS-R

MY(S)

MYK

MYQ-MYH

Common Options (Order Separately)

Common Precautions

## MY4□(S)

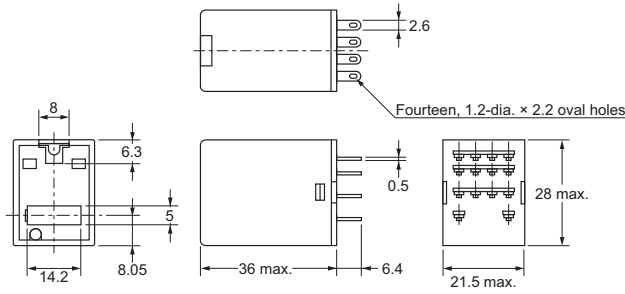

Note: The picture is lockable test button type.

### Terminal Arrangement/Internal Connections (Bottom View)

MY4(Z)IN(S)  
(DC Models)

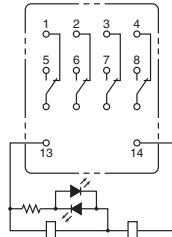

MY4(Z)IN(S)  
(AC Models)

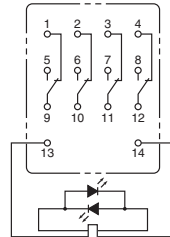

MY4(Z)IN-D2(S)  
(DC Models Only)

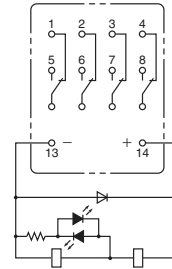

MY4(Z)IN-CR(S)  
(AC Models Only)

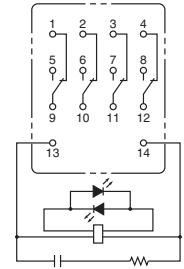

MY4(Z)IN1(S)  
(DC Models)

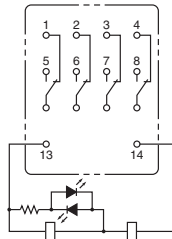

MY4(Z)IN1-D2(S)  
(DC Models Only)

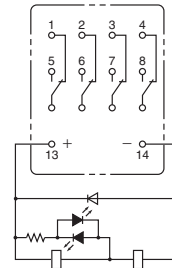

Note: For the DC models, check the coil polarity when wiring and wire all connections correctly.

## MY4□-CBG

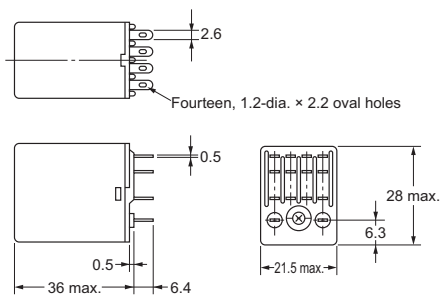
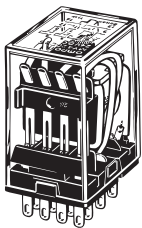

### Terminal Arrangement/Internal Connection Diagram (Bottom View) MY4Z-CBG (AC/DC Models)

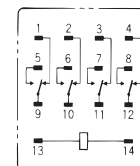

(The coil has no polarity.)

●PCB terminals

MY2-02  
MY3-02  
MY4□-02



The figure and outline drawing show MY4-02. The 2-pole and 3-pole models conform to these dimensions.

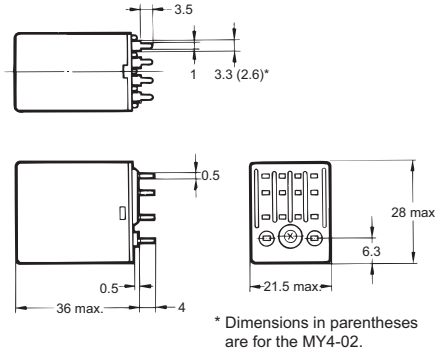

PCB Processing Dimensions (Bottom View)

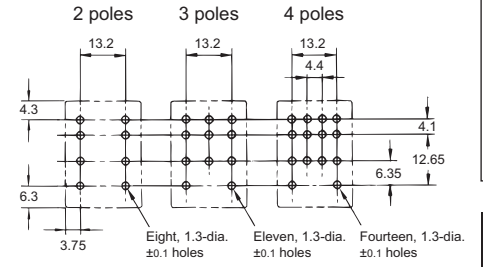

**Note:** 1. The dimensional tolerance is ±0.1.  
2. Refer to the terminal arrangement and internal connections diagrams for the MY2, MY3, MY4, and MY4Z.

●Case-surface mounting

MY2F  
MY3F  
MY4□F



The above figure is for the MY4F. The 2-pole and 3-pole models conform to these dimensions.

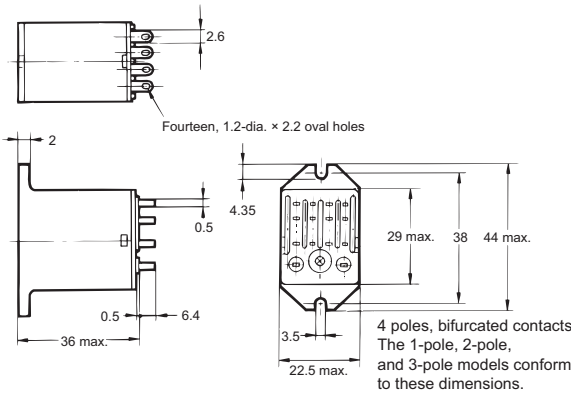

Mounting Hole Dimensions

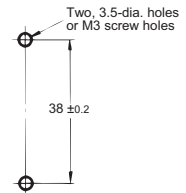

**Note:** Refer to the terminal arrangement and internal connections diagrams for the MY2, MY3, MY4, and MY4Z.

MY-GS-R

MY(S)

MYK

MYQ-MYH

Common Options (Order Separately)

Common Precautions

MY-GS-R

## Latching miniature power relays that retain contact operation status

- A low power consumption type that retains contacts using a magnetic lock system.
- Equipped with mechanical operation indicators to make operation status easy-to-see.



MY(S)

⚠ Refer to *Safety Precautions* on pages 62 to 63 and *Safety Precautions for All Relays*.

## Features

### Latching Relays MYK

Retains contact operation status.

Contact operation status can be seen at a glance thanks to the mechanical operation indicator.

MYK

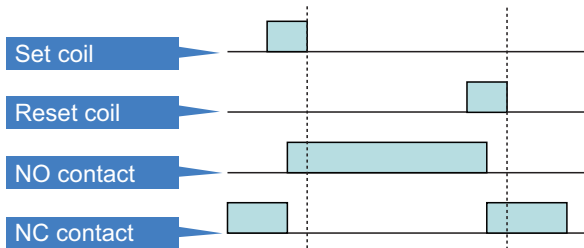

NO contact turns on when voltage is applied to the set coil and stays on even if voltage stops being applied to the set coil. NO contact turns off when voltage is applied to the reset coil, after which NC contact will turn on.\*

\*MYK features a magnetic lock system.

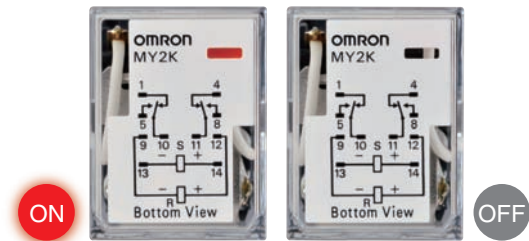

MYQ-MYH

Common Options (Order Separately)

Common Precautions



## Model Number Structure

### Model Number Legend

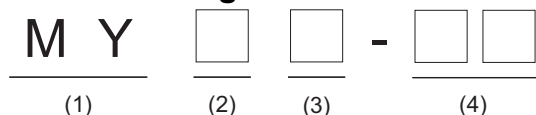

**(1) Basic model name**

MY: Miniature Power Relays

**(3) Type**

K: Latching relay

**(2) Number of poles/contacts**

2: 2-pole, single

**(4) Options, terminal type**

None: Plug-in terminals

02: PCB terminals

## Ordering Information

When your order, specify the rated voltage.

### Main unit

● Plug-in terminals

Classification	Number of poles	Contacts	Model	Rated voltage
Standard models (compliant with Electrical Appliances and Material Safety Act)	2	Single	MY2K	12, 24, 100, 100/110 VAC
				12, 24, 48 VDC

● PCB terminals

Classification	Number of poles	Contacts	Model	Rated voltage
Standard models (compliant with Electrical Appliances and Material Safety Act)	2	Single	MY2K-02	24, 100 VAC
				12, 24 VDC

MY-GS-R

MY(S)

MYK

MYQ-MYH

Common Options (Order Separately)

Common Precautions

# Ratings and Specifications

## Ratings

### ● Operating coil

Rated voltage (V)	Set coil			Reset coil			Must operate voltage (V)	Must release voltage (V)	Maximum voltage (V)	Power consumption (VA, W)	
	Rated current (mA)		Coil resistance (Ω)	Rated current (mA)		Coil resistance (Ω)				Set coil	Reset coil
	50 Hz	60 Hz		50 Hz	60 Hz						
AC	12	57	56	72	39	38.2	80% max.*	80% max.	110% max. of rated voltage	Approx. 0.6 to 0.9 (at 60 Hz)	Approx. 0.2 to 0.5 (at 60 Hz)
	24	27.4	26.4	320	18.6	18.1					
	100	7.1	6.9	5,400	3.5	3.4					
DC	12	110		110	50		80% max.*	80% max.	110% max. of rated voltage	Approx. 1.3	Approx. 0.6
	24	52		470	25						
	48	27		1,800	16						

**Note:** 1. The rated current for AC is the value measured with a DC ammeter in half-wave rectification.  
 2. The rated current and coil resistance are measured at a coil temperature of 23°C with tolerances of +15%/-20% for AC rated current and ±15% for DC coil resistance.  
 3. The AC coil resistance is a reference value only.  
 4. Operating characteristics were measured at a coil temperature of 23°C.  
 5. The maximum voltage capacity was measured at an ambient temperature of 23°C.  
 \*There is variation between products, but actual values are 80% maximum.

### ● Contact Ratings

Number of poles (contact configuration) Contact structure	2-pole (DPDT)	
	Single	
	Resistive load	Inductive load (cos φ = 0.4, L/R = 7 ms)
Rated load	3 A at 220 VAC 3 A at 24 VDC	0.8 A at 220 VAC 1.5 A at 24 VDC
Rated carry current	3 A	
Maximum switching voltage	250 VAC, 125 VDC	
Maximum switching current	3 A	
Maximum switching power	660 VA 72 W	176 VA 36 W
Contact material	Au plating + Ag	

## Characteristics

Contact resistance*1	50 mΩ max.	
Set	Operate time*2	AC: 30 ms max., DC: 15 ms max.
	Minimum pulse width	AC: 60 ms, DC: 30 ms
Reset	Release time*2	AC: 30 ms max., DC: 15 ms max.
	Minimum pulse width	AC: 60 ms, DC: 30 ms
Maximum switching frequency	Mechanical	18,000 operations/h
	Rated load	1,800 operations/h
Insulation resistance*3	100 MΩ min.	
Dielectric strength	Between coil and contacts Between contacts of different polarity	1,500 VAC at 50/60 Hz for 1 min
	Between contacts of the same polarity	1,000 VAC at 50/60 Hz for 1 min
	Between set/reset coils	
Vibration resistance	Destruction	10 to 55 to 10 Hz, 0.5-mm single amplitude (1.0-mm double amplitude)
	Malfunction	10 to 55 to 10 Hz, 0.5-mm single amplitude (1.0-mm double amplitude)
Shock resistance	Destruction	1,000 m/s <sup>2</sup>
	Malfunction	200 m/s <sup>2</sup>
Endurance	Mechanical	100,000,000 operations min. (switching frequency: 18,000 operations/h)
	Electrical*4	200,000 operations min. (at rated load, switching frequency: 1,800 operations/h)
Failure rate P value (reference value)*5	1 mA at 1 VDC	
Ambient operating temperature*6	-55 to 60°C	
Ambient operating humidity	5% to 85%	
Weight	Approx. 30 g	

**Note:** The data shown above are initial values.  
 \*1. Measurement conditions: 1 A at 5 VDC using the voltage drop method.  
 \*2. Measurement conditions: With rated operating power applied, not including contact bounce.  
 \*3. Measurement conditions: For 500 VDC applied to the same location as for dielectric strength measurement.  
 \*4. Ambient temperature condition: 23°C  
 \*5. This value was measured at a switching frequency of 120 operations per minute.  
 \*6. With no icing or condensation.

# Engineering Data (Reference Value)

## Maximum Switching Capacity MY2K(-02)

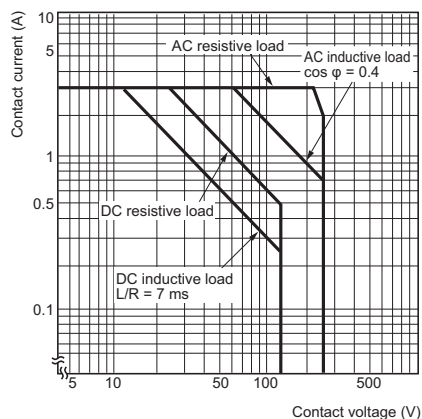

## Endurance Curve MYK(-02)

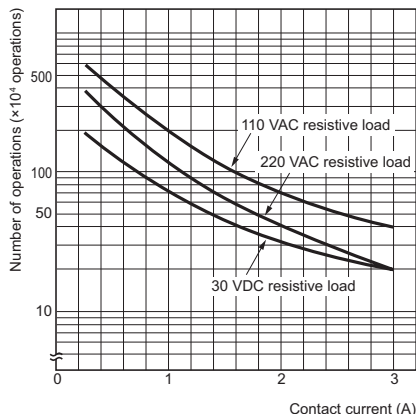

## MYK(-02)

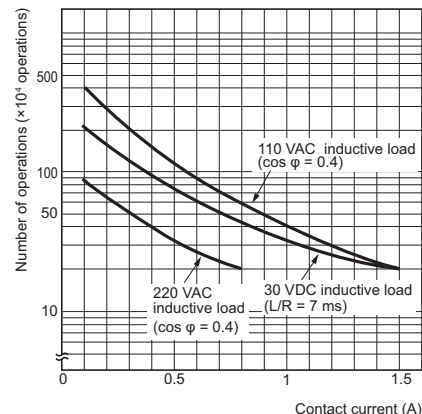

## Magnetic Interference (External Magnetic Field) MY2K 24 VDC

(Average values)

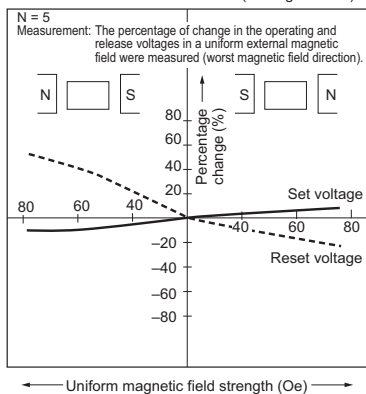

## Latching Deterioration Over Time MY2K 24 VDC

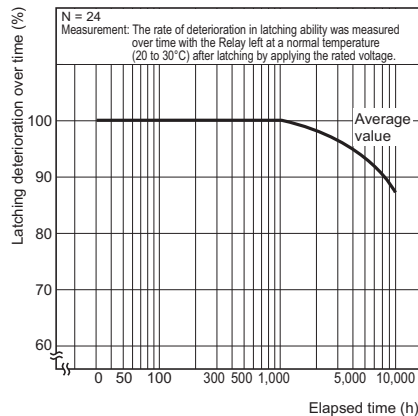

## Shock Malfunction MY2K 100 VAC

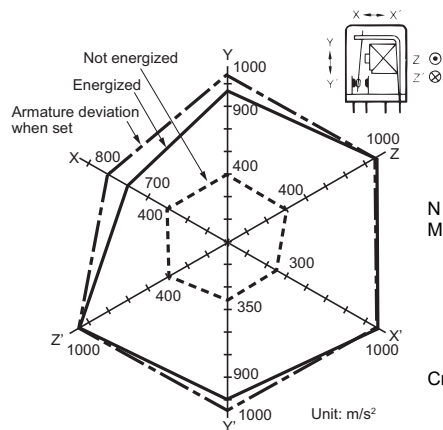

N = 20  
 Measurement: Shock was applied in 6 directions along 3 axes 2 times with the Relay energized and 3 times with the Relay not energized to check the shock values that cause the Relay to malfunction.  
 Criteria: Non-energized: 200 m/s<sup>2</sup>  
 Energized: 200 m/s<sup>2</sup>

MY-GS-R

MY(S)

MYK

MYQ-MYH

Common Options (Order Separately)

Common Precautions

Dimensions

(Unit: mm)

MY-GS-R

● Plug-in terminals  
MY2K

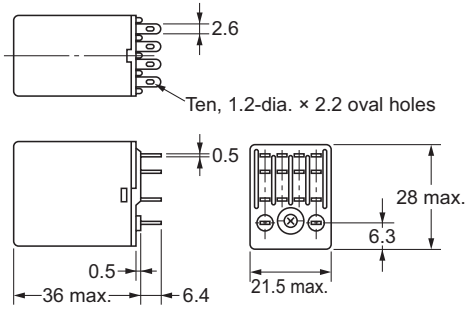
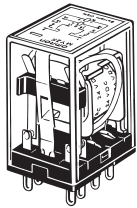

Terminal Arrangement/  
Internal Connection Diagram  
(Bottom View)

For AC

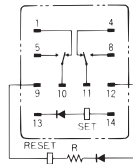

For DC

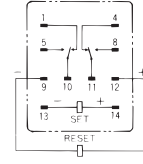

**Note:** R is a resistor for ampere-turn correction. Built into models with specifications of 50 VAC or more. (The coil has no polarity.)

**Note:** Pay close attention to the set coil and reset coil polarities. If the connections are not correct, unintended operation may occur.

MY(S)

● PCB terminals  
MY2K-02

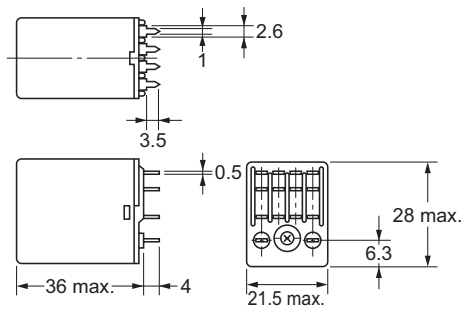
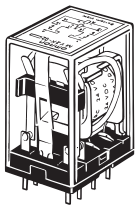

PCB Processing Dimensions  
(Bottom View)

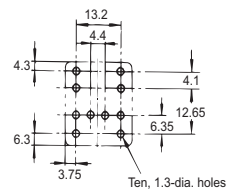

**Note:** The dimensional tolerance is  $\pm 0.1$ .

MYK

MYQ-MYH

Common Options (Order Separately)

Common Precautions

## Sealed relays that are tough in environments where dust or corrosive gases, etc., are present

- Plastic sealed relays (MYQ) and hermetically sealed relays (MYH) that are resistant to effects from the surrounding environment
- Highly airtight structures that are tough in environments where corrosive gases such as chloride gas, sulfuric gas, and silicone gas are generated. They are also resistant to environments where salt damage is occurred and where dust is generated.
- Prevent relay contact failures via a highly airtight structure.



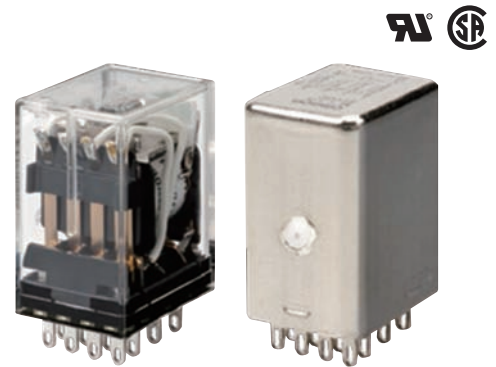

 Refer to *Safety Precautions* on pages 62 to 63 and *Safety Precautions for All Relays*.

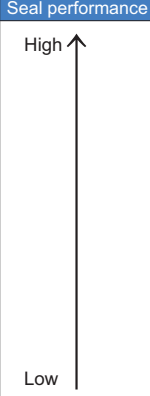

Refer to the standards certifications and compliance section of your OMRON website for the latest information on certified models.

## Features

### Highly Airtight Relays (Plug-in Terminals)

Seal performance	Degree of protection	Typical relay	Features
	 Hermetically sealed	MYH	Sealing with metals, the glass case and base, etc. with inert gases (N <sub>2</sub> ) inside makes it airtight structure which provides the external casing with durability against harmful corrosion, and prevents corrosive gases from intruding inside relays.
	 Plastic sealed	MYQ	Structure that seals relays with the resin case and cover, etc., to prevent effects from corrosive environments.
	 Closed type (cased)	MY, MY4Z-CBG	Relays in the case realize the structure that protects them from contact with foreign materials.

### Plastic Sealed Relays: MYQ

These realize excellent reliability even in environments where salt damage occurs or where dust is generated.

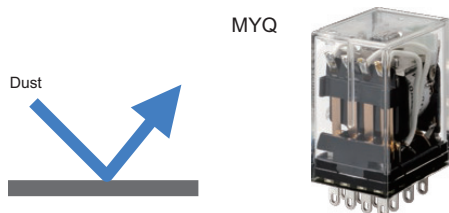

### Hermetically Sealed Relays: MYH

These realize excellent reliability even in environments where dust is generated or where corrosive gases (chloride gas, sulfuric gas, silicone gas, etc.) are present.

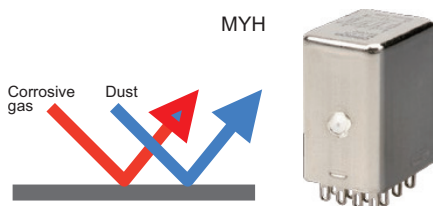

MY-GS-R

MY(S)

MYK

MYQ-MYH

Common Options (Order Separately)

Common Precautions

# MYQ-MYH

## Model Number Structure

### Model Number Legend

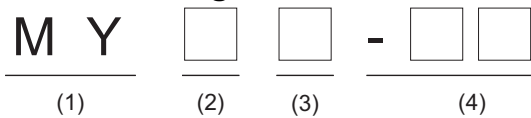

#### (1) Basic model name

MY: Miniature Power Sealed Relays

#### (3) Type

None: None  
 N: With operation indicator\*  
 \*Only MYQ (plastic sealed relay)

#### (2) Contacts/seals

Q4: 4-pole, single contacts, plastic sealed relays  
 Q4Z: 4-pole, bifurcated contacts, plastic sealed relays  
 4H: 4-pole, single contacts, hermetically sealed relays  
 4ZH: 4-pole, bifurcated contacts, hermetically sealed relays

#### (4) Options, terminal type

None: Plug-in terminals  
 02: Plastic sealed relays, PCB terminals  
 0: Hermetically sealed relays, PCB terminals

## Ordering Information

When your order, specify the rated voltage.

### Plastic Sealed Relays

#### ● Plug-in terminals

Classification	Number of poles	Contacts	Model	Rated voltage	With operation indicator	
					Model	Rated voltage
Standard models (compliant with Electrical Appliances and Material Safety Act)	4	Single	MYQ4	100/110, 110/120, 200/220, 220/240 VAC	MYQ4N	24, 100/110, 110/120, 200/220, 220/240 VAC
				24 VDC		12, 24, 48, 100/110 VDC
		Bifurcated	MYQ4Z	100/110, 110/120, 200/220 VAC		
				12, 24 VDC		

#### ● PCB terminals

Classification	Number of poles	Contacts	Model	Rated voltage
Standard models (compliant with Electrical Appliances and Material Safety Act)	4	Single	MYQ4-02	50, 200/220, 220/240 VAC
				24 VDC
		Bifurcated	MYQ4Z-02	100/110 VAC
				24, 48 VDC

### Hermetically Sealed Relays

#### ● Plug-in terminals

Classification	Number of poles	Contacts	Model	Rated voltage
Standard models (compliant with Electrical Appliances and Material Safety Act)	4	Single	MY4H	24, 100/110, 110/120 VAC
				12, 24, 48, 100/110 VDC
		Bifurcated	MY4ZH	24, 100/110, 110/120 VAC
				12, 24, 48, 100/110 VDC

#### ● PCB terminals

Classification	Number of poles	Contacts	Model	Rated voltage
Standard models (compliant with Electrical Appliances and Material Safety Act)	4	Single	MY4H-0	110/120 VAC
				24 VDC
		Bifurcated	MY4ZH-0	24, 100/110 VDC

MY-GS-R

MY(S)

MYK

MYQ-MYH

Common Options (Order Separately)

Common Precautions

# Ratings and Specifications

## ● Operating coil

Rated voltage (V)	Rated current (mA)		Coil resistance (Ω)	Coil inductance (H)		Must operate voltage (V)*1	Must release voltage (V)*2	Maximum voltage (V)	Power consumption (VA, W)
	50 Hz	60 Hz		Armature OFF	Armature ON				
AC	24	53.8	46	180	0.69	1.3	80% max.	110% max. of rated voltage	Approx. 0.9 to 1.3 (at 60 Hz)
	100/110	11.7/12.9	10/11	3,750	14.54	24.6			
	110/120	9.9/10.8	8.4/9.2	4,430	19.2	32.1			
	200/220	6.2/6.8	5.3/5.8	12,950	54.75	91.07			
	220/240	4.8/5.3	4.2/4.6	18,790	83.5	136.4			
DC	12	75		165	0.734	1.37	10% min.		Approx. 0.9
	24	36.9		650	3.2	5.72			
	48	18.5		2,600	10.6	21.0			
	100/110	9.1/10		11,000	45.6	86.0			

- Note:**
- The rated current and coil resistance are measured at a coil temperature of 23°C with tolerances of +15%/-20% for AC rated current and ±15% for DC coil resistance.
  - The AC coil resistance and coil inductance values are for reference only.
  - Operating characteristics were measured at a coil temperature of 23°C.
  - The maximum voltage capacity was measured at an ambient temperature of 23°C.
- \*1. There is variation between products, but actual values are 80% maximum. To ensure operation, apply at least 80% of the rated value.  
 \*2. There is variation between products, but actual values are 30% minimum for AC and 10% minimum for DC. To ensure release, use a value that is lower than the specified value.

## ● Contact Ratings

### Plastic Sealed Relays: MYQ

Number of poles (contact configuration)	4-pole (4PDT)	
	Single/bifurcated	
	Resistive load	Inductive load (cos φ = 0.4, L/R = 7 ms)
Rated load	1 A at 220 VAC 1 A at 24 VDC	0.5 A at 220 VAC 0.5 A at 24 VDC
Rated carry current	1 A	
Maximum switching voltage	250 VAC 125 VDC	
Maximum switching current	1 A	
Maximum switching power	220 VA 24 W	110 VA 12 W
Contact material	Au plating + Ag	

### Hermetically Sealed Relays: MYH

Number of poles (contact configuration)	4-pole (4PDT)			
	Single		Bifurcated	
	Resistive load	Inductive load (cos φ = 0.4, L/R = 7 ms)	Resistive load	Inductive load (cos φ = 0.4, L/R = 7 ms)
Rated load	3 A at 110 VAC 3 A at 24 VDC	0.8 A at 110 VAC 1.5 A at 24 VDC	3 A at 110 VAC 3 A at 24 VDC	0.8 A at 110 VAC 1.5 A at 24 VDC
Rated carry current	3 A			
Maximum switching voltage	125 VAC 125 VDC			
Maximum switching current	3 A			
Maximum switching power	330 VA 72 W	88 VA 36 W	330 VA 72 W	88 VA 36 W
Contact material	Au plating + Ag			

MY-GS-R

MY(S)

MYK

MYQ·MYH

Common Options (Order Separately)

Common Precautions

Characteristics

Model		MYQ	MYH
Contact resistance*1		50 mΩ max.	
Operate time*2		20 ms max.	
Release time*2		20 ms max.	
Maximum switching frequency	Mechanical	18,000 operations/h	
	Rated load	1,800 operations/h	
Insulation resistance*3		100 MΩ min.	
Dielectric strength	Between coil and contacts	1,500 VAC at 50/60 Hz for 1 min	1,000 VAC at 50/60 Hz for 1 min
	Between contacts of different polarity	1,500 VAC at 50/60 Hz for 1 min	1,000 VAC at 50/60 Hz for 1 min
	Between contacts of the same polarity	1,000 VAC at 50/60 Hz for 1 min	700 VAC at 50/60 Hz for 1 min
Vibration resistance	Destruction	10 to 55 to 10 Hz, 0.5-mm single amplitude (1.0-mm double amplitude)	
	Malfunction	10 to 55 to 10 Hz, 0.5-mm single amplitude (1.0-mm double amplitude)	
Shock resistance	Destruction	1,000 m/s <sup>2</sup>	
	Malfunction	200 m/s <sup>2</sup>	
Endurance	Mechanical	Single contacts: AC: 50,000,000 operations min., DC: 100,000,000 operations min. Bifurcated contacts: 5,000,000 operations min., DC: 5,000,000 operations min. (switching frequency: 18,000 operations/h)	Single contacts: 50,000,000 operations min. Bifurcated contacts: 5,000,000 operations min. (switching frequency: 18,000 operations/h)
	Electrical*4	Single contacts: 200,000 operations min. Bifurcated contacts: 100,000 operations min. (at rated load, switching frequency: 1,800 operations/h)	Single contacts: 100,000 operations min. Bifurcated contacts: 50,000 operations min. (at rated load, switching frequency: 1,800 operations/h)
Failure rate P Level (reference value)*5		Single contacts: 1 mA at 1 VDC Bifurcated contacts: 100 μA at 1 VDC	Single contacts: 100 μA at 1 VDC Bifurcated contacts: 100 μA at 100 mVDC
Ambient operating temperature*6		-55 to 60°C	-25 to 60°C
Ambient operating humidity		5% to 85%	
Weight		Approx. 35 g	Approx. 50 g

Note: The data shown above are initial values.

- \*1. Measurement conditions: 1 A at 5 VDC using the voltage drop method.
- \*2. Measurement conditions: With rated operating power applied, not including contact bounce.  
Ambient temperature condition: 23°C
- \*3. Measurement conditions: For 500 VDC applied to the same location as for dielectric strength measurement.
- \*4. Ambient temperature condition: 23°C
- \*5. This value was measured at a switching frequency of 120 operations per minute.
- \*6. With no icing or condensation.



# Engineering Data (Reference Value)

MY-GS-R

MY(S)

MYK

MYQ-MYH

Common Options (Order Separately)

Common Precautions

## Maximum Switching Capacity MYQ4(Z)

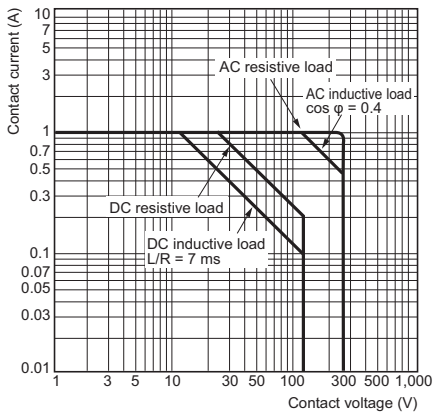

## MY4(Z)H

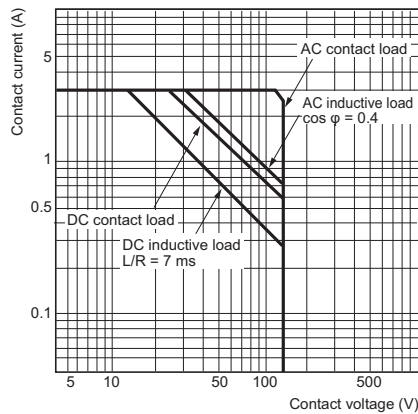

## Endurance Curve

### MYQ4

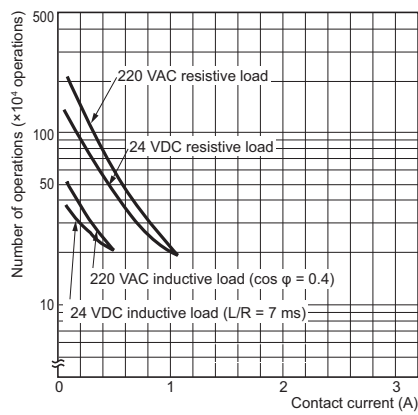

Note: The endurance of bifurcated contacts is one-half that of single contacts.

### MY4H

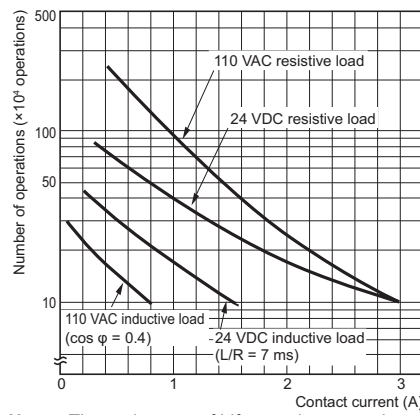

Note: The endurance of bifurcated contacts is one-half that of single contacts.

## H<sub>2</sub>S Gas Data

### MYQ4

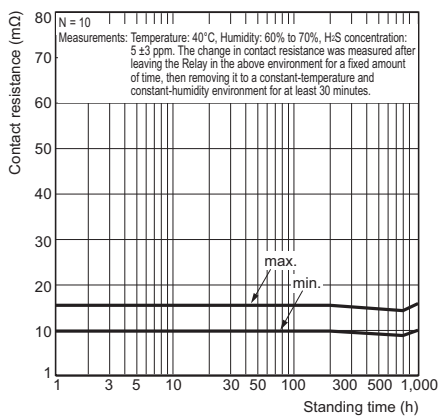

## Shock Malfunction

### MYQ4

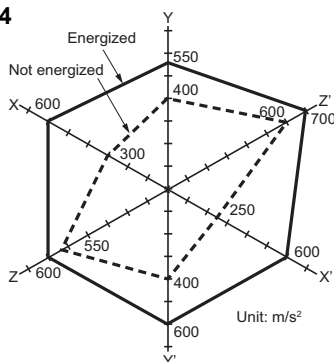

N = 20

Measurement: Shock was applied 3 times each in 6 directions along 3 axes with the Relay energized and not energized to check the shock values that cause the Relay to malfunction.

Criteria: Non-energized: 200 m/s<sup>2</sup>  
Energized: 200 m/s<sup>2</sup>

Shock direction



Dimensions

(Unit: mm)

● Plug-in terminals

Plastic Sealed Relays

MYQ4(Z)(N)

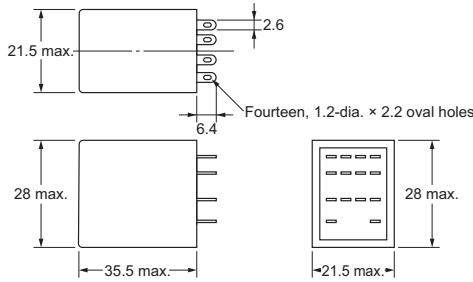
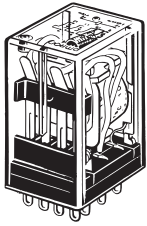

MYQ4(Z)N

DC Models

AC Models

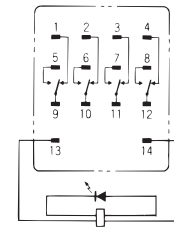
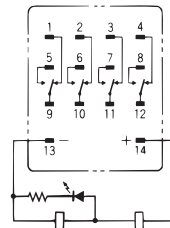

(Coil has polarity)

(Coil has no polarity)

- Note:**
1. An AC model has coil disconnection self-diagnosis.
  2. For the DC models, check the coil polarity when wiring and wire all connections correctly.

Hermetically Sealed Relays

MY4(Z)H

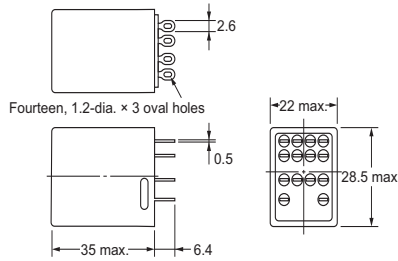
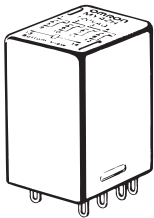

Terminal Arrangement/  
Internal Connection Diagram  
(Bottom View)  
MY4(Z)H

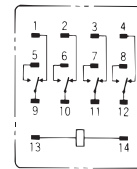

(Coil has no polarity)

● PCB terminals

Plastic Sealed Relays

MYQ4(Z)-02

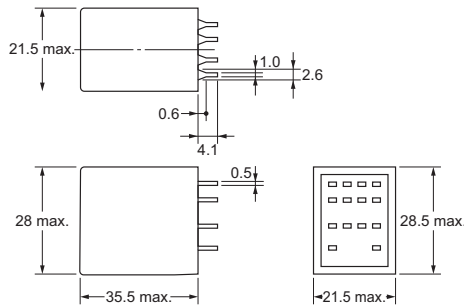
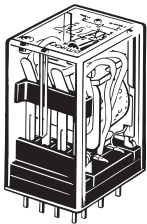

PCB Processing Dimensions  
(Bottom View)

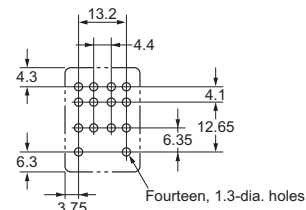

- Note:** The dimensional tolerance is  $\pm 0.1$ .

Hermetically Sealed Relays

MY4(Z)H-0

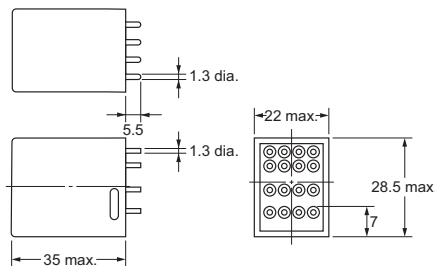
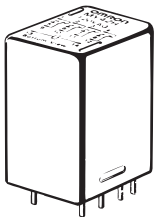

PCB Processing Dimensions  
(Bottom View)

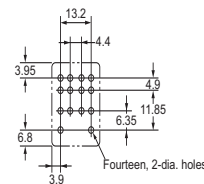

MY-GS-R

MY(S)

MYK

MYQ-MYH





Common Options (Order Separately)

Common Precautions

Common Options (Order Separately)

Ordering Information

Front-mounting Sockets

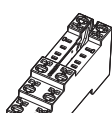
Applicable relay model*1	Mounting Method	Conductive part protection	Terminal Type	Applicable crimp terminal/ Electric wire	Appearance	Model	Hold-down Clips/ Release Levers (Order Separately)
MY2□ MY2□(S) MY2Z□-CR	Mounted on a DIN track or with screws	Available	Push-In Plus Terminal	Ferrules Solid wire Stranded wire		<b>PYF-08-PU*2</b> * MY2Z□-CR, MY2□-CR 24 VAC cannot be used	With release lever * Hold by release lever
						<b>PYF-08-PU-L*2</b>	
			Screw terminal (M3 screw size)	Forked terminals Solid wire Stranded wire		<b>PYFZ-08-E*4</b>	MY2□: PYC-A1 MY2IN(S): PYC-E1 MY2Z□-CR, MY2□-CR 24 VAC: Y92H-3
						<b>PYF08A-N</b>	
		Option (Terminal cover sold separately) *3	Round terminals Forked terminals Solid wire Stranded wire		<b>PYFZ-08</b> * Terminal cover: PYCZ-C08		
		Mounted on a DIN track	Available	Screwless terminal (Clamp method)	Solid wire Stranded wire		
Mounted on a DIN track or with screws	None					Screw terminal (M3 screw size)	Round terminals Forked terminals Solid wire Stranded wire

\*1. The applicable relay model is a plug-in terminal type.  
 \*2. There are screw mounting holes in the DIN hooks on the PYF-□□-PU and P2RF-□□-PU. Pull out the DIN hook tabs to mount the Sockets with screws.  
 \*3. Terminal cover type is PYCZ-C08. (Order Separately) For details, refer to the *For Screw Terminal Sockets (PYFZ-08/PYFZ-14) Terminal covers* on page 50.  
 \*4. The finger-protection type (PYFZ-□-E) is a type in which the terminal cover is integrated into the socket. Round terminals cannot be used. Use forked terminals or ferrules instead.

MY-GS-R

MY(S)

MYK

MYQ-MYH

Common Options (Order Separately)

Common Precautions







# MY-GS/MY(S)/MYK/MYQ·MYH

MY-GS-R

MY(S)

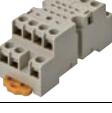
MYK

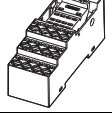
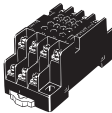
MYQ·MYH



Applicable relay model*1	Mounting Method	Conductive part protection	Terminal Type	Applicable crimp terminal/ Electric wire	Appearance	Model	Hold-down Clips/ Release Levers (Order Separately)
MY4□ MY4□(S) MY4□H MYQ4□ MY4Z□-CBG-CR MY2K	Mounted on a DIN track or with screws	Available	Push-In Plus Terminal	Ferrules Solid wire Stranded wire		<b>PYF-14-PU*2</b> * MY4ZN-CBG-CR, MY4-CR 24 VAC, MY4N-CR 24 VAC/115 VAC cannot be used	With release lever * Hold by release lever
						<b>PYF-14-PU-L*2</b>	
			Screw terminal (M3 screw size)	Forked terminals Solid wire Stranded wire		<b>PYFZ-14-E*4</b>	MY4Z□-CBG-CR, MY4-CR 24 VAC, MY4N-CR 24 VAC/115 VA: Y92H-3 Other than those above: PYC-A1
						<b>PYF14A-N</b>	
	Option (Terminal cover sold separately) *3	Round terminals Forked terminals Solid wire Stranded wire		<b>PYFZ-14</b> * Terminal cover: PYCZ-C14			
	Mounted on a DIN track	Available	Screwless terminal (Clamp method)	Solid wire Stranded wire		<b>PYF14S</b>	PYCM-14S * MY4Z□-CBG-CR, MY4-CR 24 VAC, MY4N-CR 24 VAC/115 VAC cannot be used * Hold by release lever
Mounted on a DIN track or with screws	None	Screw terminal (M3.5 screw size)	Round terminals Forked terminals Solid wire Stranded wire		<b>PYF14T</b>	MY4Z□-CBG-CR: Y92H-3 Other than those above: PYC-A1	
MY2 and MY4	Mounted on a DIN track or with screws	Available	Rise-Up terminal	Solid wire Stranded wire		<b>PYF14-ESS-B</b>	PYC-35-B
						<b>PYF14-ESN-B</b>	

- \*1. The applicable relay model is a plug-in terminal type.
- \*2. There are screw mounting holes in the DIN hooks on the PYF-□□-PU and P2RF-□□-PU. Pull out the DIN hook tabs to mount the Sockets with screws.
- \*3. Terminal cover type is PYCZ-C14. (Order Separately) For details, refer to the *For Screw Terminal Sockets (PYFZ-08/PYFZ-14) Terminal covers* on page 50.
- \*4. The finger-protection type (PYFZ-□-E) is a type in which the terminal cover is integrated into the socket. Round terminals cannot be used. Use forked terminals or ferrules instead.

Common Options (Order Separately)

Common Precautions

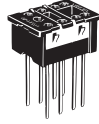
Back-mounting Sockets

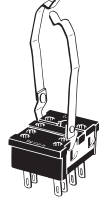
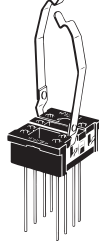
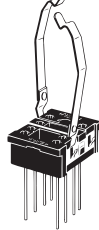
Applicable relay model*1	Terminal Type	Hold-down Clips	Appearance	Model
MY2□ MY2□(S) MY2Z□-CR	Solder terminals	Accessories (Order Separately) * MY2Z□-CR: PYC-1 Other than those above: PYC-P		PY08
	Wrapping terminals Terminal length: 25 mm			PY08QN
	Wrapping terminals Terminal length: 20 mm			PY08QN2
	PCB terminals			PY08-02
MY2□ MY2□(S)	Solder terminals	With Hold-down Clips*2		PY08-Y1
	Wrapping terminals Terminal length: 25 mm			PY08QN-Y1
	Wrapping terminals Terminal length: 20 mm			PY08QN2-Y1

\*1. The applicable relay model is a plug-in terminal type.

\*2. The hold-down clips for connecting the relay and socket come as a set with the socket.

MY-GS-R

MY(S)

MYK

MYQ-MYH

Common Options (Order Separately)

Common Precautions

# MY-GS/MY(S)/MYK/MYQ·MYH

MY-GS-R





MY(S)

MYK

MYQ·MYH

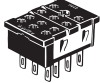
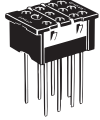
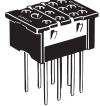
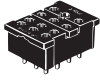
Common Options (Order Separately)

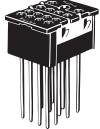
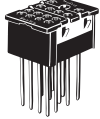

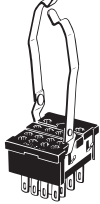
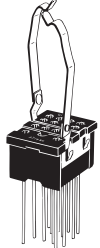
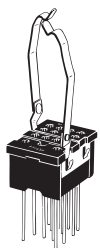
Common Precautions

Applicable relay model*1	Terminal Type	Hold-down Clips	Appearance	Model
MY3□	Solder terminals	Accessories (Order Separately) * PYC-P		PY11
	Wrapping terminals Terminal length: 25 mm	Accessories (Order Separately) * PYC-P		PY11QN
	Wrapping terminals Terminal length: 20 mm	Accessories (Order Separately) * PYC-P		PY11QN2
	PCB terminals	Accessories (Order Separately) * PYC-P		PY11-02
MY4□ MY4□(S) MY4□H MYQ4□ MY4Z□-CBG-CR MY2K	Solder terminals	Accessories (Order Separately) * MY4Z□-CBG-CR: PYC-1 Other than those above: PYC-P		PY14
	Wrapping terminals Terminal length: 25 mm			PY14QN
	Wrapping terminals Terminal length: 20 mm			PY14QN2
	PCB terminals			PY14-02
MY4□ MY4□(S) MY4□H MYQ4□ MY2K	Solder terminals	With Hold-down Clips*2		PY14-Y1
	Wrapping terminals Terminal length: 25 mm			PY14QN-Y1
	Wrapping terminals Terminal length: 20 mm			PY14QN2-Y1

\*1. The applicable relay model is a plug-in terminal type.

\*2. The hold-down clips for connecting the relay and socket come as a set with the socket.

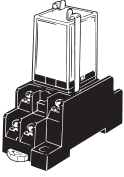
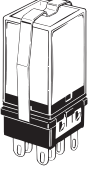
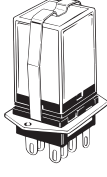
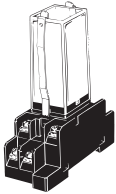
Hold-down Clip

Appearance*1	Model*2	Weight*3	Application
	PYC-A1	Approx. 0.54 g	For connecting relays and sockets  For connecting sockets, socket mounting plates, and relays  For connecting models with built-in CR circuit for coil surge absorption (MY2Z□-CR) and sockets
	PYC-E1	Approx. 0.6 g	
	PYC-P	Approx. 1.4 g	
	PYC-S	Approx. 1.8 g	
	Y92H-3*4	Approx. 0.7 g	
	PYC-1*5	Approx. 6 g	

- \*1. The appearance shown is one in which the relay, socket, and hold-down clip are assembled.
- \*2. Hold-down clips are used in sets of two. However, PYC-P and PYC-1.
- \*3. The weight shown above is the weight for one hold-down clip.
- \*4. MY2-CR 24 VAC, MY2N-CR 24 VAC, MY4-CR 24 VAC and MY4N-CR 24 VAC/115 VAC use in combination with hold-down clip Y92H-3.
- \*5. MY2-CR 24 VAC, MY2N-CR 24 VAC, MY4-CR 24 VAC and MY4N-CR 24 VAC/115 VAC use in combination with hold-down clip PYC-1.

MY-GS-R

MY(S)

MYK

MYQ-MYH

Common Options (Order Separately)

Common Precautions

## ●Front-connecting Socket Accessories

For Push-In Plus Terminal Sockets (PYF-08-PU(-L)/PYF-14-PU(-L))

### Short Bars

Applicable sockets	Pitch	Application	Shape/external dimensions	Number of poles	L (Length)	Insulation color	Model*1
PYF-08-PU(-L) PYF-14PU(-L)	7.75 mm	Bridging contact terminals (common)		2	15.1	Red (R) Blue (S) Yellow(Y)	PYDN-7.75-020□
	31.0 mm	For Coil terminals		3	22.85		PYDN-7.75-030□
4				30.6	PYDN-7.75-040□		
20				154.6	PYDN-7.75-200□		
			8	224.35	PYDN-31.0-080□		

\*1. Replace the box (□) in the model number with the code for the covering color. □Color selection: R = Red, S = Blue, Y = Yellow

### Labels

Applicable sockets	Model	Manufacturer	Minimum order (Box) (quantity per box)
PYF-08-PU(-L) PYF-14PU(-L)	MG-CPM-04 41390N	Cembre	1,680 (35 sheet / 48 pieces)

Note: PRINTER: MARKINGENIUS MG3 (Ask to your Omron contact for more details on printers)

## For Screwless Terminal Sockets (PYF08S/PYF14S)

### Short Bars

Applicable sockets	Pitch	Application	Shape/external dimensions	Number of poles	Insulation color	Model*1
PYF08S	19.7 mm	For bridging coils between sockets		2	Red (R) Blue (B)	PYDM-08S□ (50 pcs./bag)
PYF14S	27.5 mm			2		PYDM-14S□ (50 pcs./bag)

\*1. Replace the box (□) in the model number with the code for the covering color. □Color selection: R = Red, B = Blue

### Labels

Applicable sockets	Model
PYF08S	R99-11 (100 pcs./bag)
PYF14S	

## Release Levers

Applicable sockets	Shape/external dimensions	Model
PYF08S		PYCM-08S
PYF14S		PYCM-14S



For Screw Terminal Sockets (PYFZ-08/PYFZ-14)  
Short Bars

Applicable sockets	Pitch	Application	Shape/external dimensions	Number of poles	Insulation color	Model*1
PYFZ-08	22 mm	For bridging adjacent sockets		2	B (Black) S (Blue) R (Red)	PYD-025B□ (2P) (10 pcs./bag)
				8		PYD-085B□ (8P) (10 pcs./bag)
PYFZ-14	29 mm	For bridging adjacent sockets		2		PYD-026B□ (2P) (10 pcs./bag)
				8		PYD-086B□ (8P) (10 pcs./bag)
	7 mm	For bridging with the same socket		2	B (Black) Y (Yellow)	PYD-020B□ (2P) (50 pcs./bag)
				3		PYD-030B□ (3P) (10 pcs./bag)

\*1. Replace the box (□) in the model number with the code for the covering color.

MY-GS-R

MY(S)

MYK

MYQ-MYH

Common Options (Order Separately)

Common Precautions

# MY-GS/MY(S)/MYK/MYQ·MYH

MY-GS-R

## For Screw Terminal Sockets (PYFZ-08/PYFZ-14)

### Terminal covers

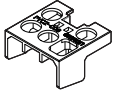
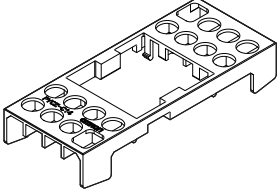
Applicable sockets	Appearance	Model
PYFZ-08		PYCZ-C08 (2 pcs/set)
PYFZ-14		PYCZ-C14 (1 pcs/set)

**Note:** 1. These covers cannot be used for PYF08A and PYF14A.  
2. A short bar (optional) cannot be used attached to the upper section because it will interfere with the terminal cover.

MY(S)

### Dimensions with terminal cover

(Unit: mm)

#### PYCZ-C08

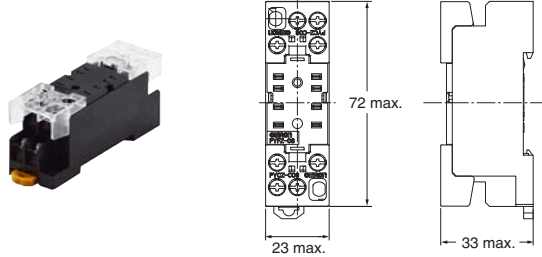

#### PYCZ-C14

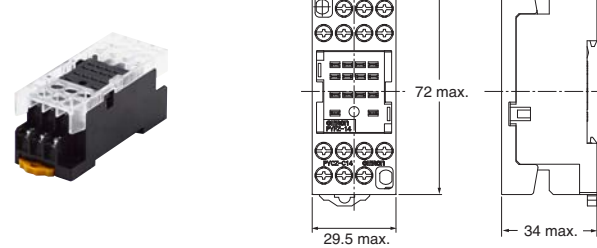

MYK



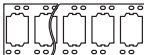
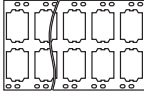

## Socket Mounting Plates (For Back-connecting Socket PY□/Solder Terminals, PY□QN(2)/Wrapping Terminals)

MYQ·MYH

Applicable Sockets		Socket Mounting Plates		
Model	Models with hold-down clips	Appearance	Number of sockets	Model
PY08 PY08QN PY08QN2 PY11 PY11QN PY11QN2 PY14 PY14QN PY14QN2	PY08-Y1 PY08QN-Y1 PY08QN2-Y1 PY14-Y1 PY14QN-Y1 PY14QN2-Y1		1	PYP-1
			18	PYP-18*
			36	PYP-36*

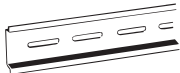
\*You can cut the PYP-18 and PYP-36 to any required length.

### Parts for Track Mounting

Type	Appearance	Model
DIN Tracks		PFP-100N
		PFP-50N
End Plate*		PFP-M
Spacer		PFP-S

**Note:** The track conforms to DIN standards.  
\*When mounting DIN track, please use End Plate (Model PFP-M).

Common Options (Order Separately)

Common Precautions

# Ratings and Specifications

## Characteristics

### Sockets

Model	Connection	Number of pins	Terminal Type	Ambient operating temperature	Ambient operating humidity	Continuous carry current	Dielectric strength *4			Insulation resistance *1 *4	Weight		
							Between contact terminals of same polarity	Between contact terminals of different polarity	Between coil and contact terminals				
PYF08-PU	Front	8	Push-In Plus Terminal	-40 to 70°C	5% to 85%	10 A*2	2,000 VAC for 1 min	2,000 VAC for 1 min	2,000 VAC for 1 min	1,000 MΩ min. (500 VAC)	Approx. 80 g		
PYF08S			Screwless terminal	-55 to 70°C							10 A	2,250 VAC for 1 min	2,250 VAC for 1 min
PYFZ-08			Screw terminal			-55 to 55°C	7 A*3	2,000 VAC for 1 min	2,000 VAC for 1 min				
PYFZ-08-E				Approx. 32 g									
PYF08A-N		11	Screw terminal	-55 to 70°C		5 A	2,000 VAC for 1 min	2,000 VAC for 1 min	2,000 VAC for 1 min		Approx. 32 g		
PYF11A											Approx. 43 g		
PYF14-PU		14	Push-In Plus Terminal	-40 to 70°C		6 A	2,000 VAC for 1 min	2,000 VAC for 1 min	2,000 VAC for 1 min		Approx. 87 g		
PYF14S											Screwless terminal	-55 to 70°C	5 A
PYFZ-14			Screw terminal	-55 to 55°C		6 A	2,250 VAC for 1 min	2,250 VAC for 1 min	2,250 VAC for 1 min		Approx. 50 g		
PYFZ-14-E											Approx. 50 g		
PYF14A-N			5 A*3	2,000 VAC for 1 min		2,000 VAC for 1 min	2,000 VAC for 1 min	2,000 VAC for 1 min	2,000 VAC for 1 min		Approx. 50 g		
PYF14T											3 A	2,000 VAC for 1 min	2,000 VAC for 1 min
PY08			Back	8		Solder terminals	-55 to 70°C	7 A	1,500 VAC for 1 min		1,500 VAC for 1 min	1,500 VAC for 1 min	100 MΩ min.
PY08-Y1		Wrapping terminals (Terminal length: 25 mm)				Approx. 9 g							
PY08QN	Wrapping terminals (Terminal length: 20 mm)				Approx. 12 g								
PY08QN-Y1		Approx. 13 g											
PY08QN2	PCB terminals	Approx. 11 g											
PY08QN2-Y1		Approx. 12 g											
PY08-02	11	Solder terminals		Approx. 7 g									
PY11		Wrapping terminals (Terminal length: 25 mm)		Approx. 9 g									
PY11QN				Wrapping terminals (Terminal length: 20 mm)	Approx. 13 g								
PY11QN2		PCB terminals			Approx. 12 g								
PY11-02	14	Solder terminals		Approx. 8 g									
PY14				Wrapping terminals (Terminal length: 25 mm)	Approx. 10 g								
PY14-Y1		Wrapping terminals (Terminal length: 20 mm)			Approx. 11 g								
PY14QN				PCB terminals	Approx. 14 g								
PY14QN-Y1		Approx. 15 g											
PY14QN2		Approx. 13 g											
PY14QN2-Y1	Approx. 14 g												
PY14-02	Approx. 9 g												

Model	Connection	Number of pins	Terminal Type	Continuous carry current	Dielectric strength	Insulation resistance *1
PYF14-ESS-B	Front	14	Rise-Up terminal	12 A	>3 kV	>5 MΩ
PYF14-ESN-B						

\*1. For 500 VDC applied to the same location as for dielectric strength measurement.  
 \*2. The carrying current of 10 A is for an ambient temperature of 55°C or below. At an ambient temperature of 70°C, the value is 7 A.  
 \*3. When using the PYF08A-N or PYF14A-N at an ambient operating temperature exceeding 40°C, reduce the continuous carry current to 60%.  
 \*4. The dielectric strength and insulation resistance values in the above table are for a single socket.

MY-GS-R

MY(S)

MYK

MYQ-MYH

Common Options (Order Separately)

Common Precautions

# MY-GS/MY(S)/MYK/MYQ-MYH

MY-GS-R

## Socket Accessories

### ●For Front-connecting Sockets

#### Short Bars

Application	Applicable sockets	Model	Maximum carry current	Ambient operating temperature	Ambient operating humidity
	PYF-08-PU(-L) PYF-14-PU(-L)	PYDN-7.75-020□	20 A	-40 to 70°C	5% to 85%
		PYDN-7.75-030□			
		PYDN-7.75-040□			
		PYDN-7.75-200□			
Bridging contact terminals (common)	PYFZ-08	PYD-025B□	20 A (However, 18 A when 70°C)	-40 to 70°C (with no icing or condensation)	45% to 85% (with no icing or condensation)
		PYD-085B□			
	PYFZ-14	PYD-026B□			
		PYD-086B□			
For Coil terminals	PYF-08-PU(-L) PYF-14-PU(-L)	PYDN-31.0-080□	20 A	-40 to 70°C	5% to 85%
	PYF08S	PYDM-08S□	10 A	-40 to 70°C	5% to 85%
	PYF14S	PYDM-14S□	10 A	-40 to 70°C	5% to 85%

MY(S)

## Certified Standards

### ●CSA certification (File No. LR031928)

Model	Ratings	Class number	Standard number
PYF-08-PU(-L)	10 A, 250 V	3211 07	CSA C22.2 No14
PYF-14-PU(-L)	6 A, 250 V*		
PYF08S	10 A, 250 V		
PYF14S	5 A, 250 V		
PYFZ-08(-E)	10 A, 250 V		
PYFZ-14(-E)	6 A, 250 V		
PY□ PYF□A	7 A, 250 V		

\*When power is supplied to all four poles, use with a total power current that does not exceed 20 A.

MYK

### ●UL certification (File No. E87929)

Model	Ratings	Standard number	Category	Listed/Recognized
PYF-08-PU(-L)	10 A, 250 V	UL508	SWIV2	Recognition
PYF-14-PU(-L)	6 A, 250 V*			
PYF08S PYF14S	10 A, 250 V			
PYFZ-08(-E)	10 A, 250 V			
PYFZ-14(-E)	6 A, 250 V			
PY□ PYF□A	7 A, 250 V			

\*When power is supplied to all four poles, use with a total power current that does not exceed 20 A.

MYQ-MYH

### ●TÜV Rheinland certification

Model	Ratings	Standard number	Certification No.
PYF-08-PU(-L)	10 A, 250 V*	EN 61984	R50327595
PYF-14-PU(-L)	6 A, 250 V		
PYFZ-08(-E)	10 A, 250 V		R50405329
PYFZ-14(-E)	6 A, 250 V		

\*Ratings are for an ambient temperature of 55°C or below. At an ambient temperature of 70°C, the value is 7 A.

Common Options (Order Separately)

### ●VDE certification

Model	Standard number	Certification No.
PYF08S	VDE0627 (EN61984)	40015509
PYF14		

### ●Others

Model	Standards	File No.
PYF14-ESN-B	UL508	E244189
PYF14-ESS-B	CSA22.2	LR225761

Common Precautions

## Dimensions

### Height with Socket

#### ●Front-connecting Sockets

- Push-In Plus Terminal (PYF-□-PU)

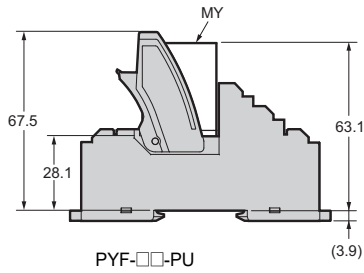

- Screwless terminal (PYF08S, PYF14S)

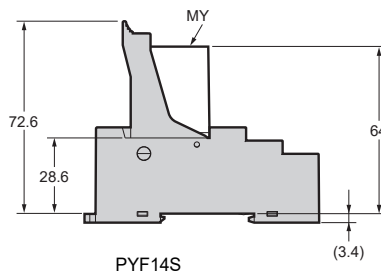
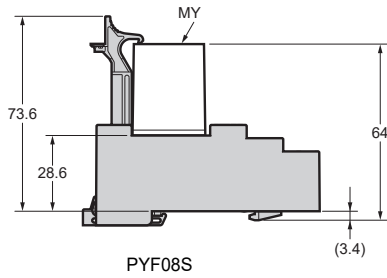

- Screw terminal (PYFZ-□(-E), PYF11A, PYF14T, PYF□A-N, PYF14-ES□-B)

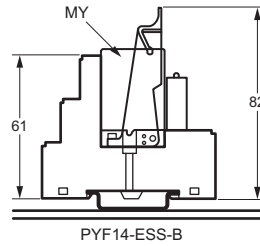
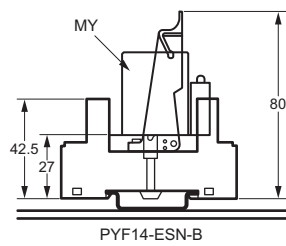
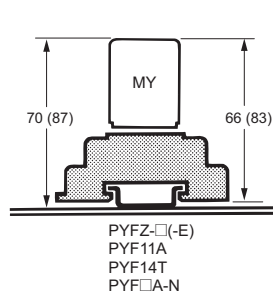

- Note:** 1. The PYF11A can be mounted on a track or with screws.  
2. The heights given in parentheses are the measurements for 53-mm-high Relays.

#### ●Back-connecting Sockets

- Solder terminals/wrapping terminals (PY□)

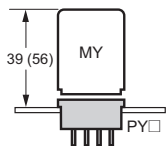

- PCB terminals (PY□-02)

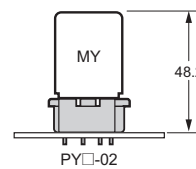

MY-GS-R

MY(S)

MYK

MYQ-MYH

Common Options (Order Separately)

Common Precautions

MY-GS-R

## Front-connecting Sockets

### ● Push-In Plus Terminal

PYF-08-PU(-L)

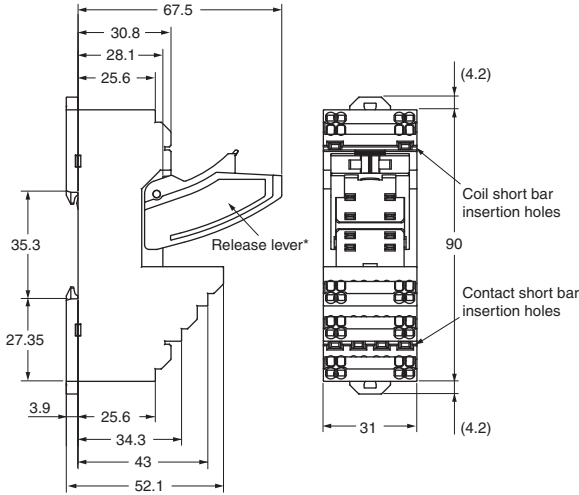
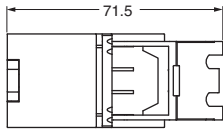

Terminal Arrangement/Internal Connection Diagram (Top View)

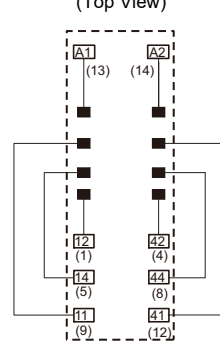

- Note:**
1. The numbers in parentheses are traditionally used terminal numbers.
  2. Insert the short bar into only the A1 or A2 side.
  3. Only the No. 11 and No. 41 terminals function as bridging contact terminals. The two insertion holes between the terminals are false terminals to allow for installation without having to fold out the short bar pins.

Mounting Hole Dimensions

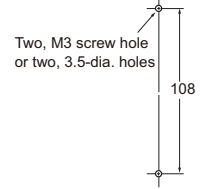

**Note:** Pull out the hooks to mount the Socket with screws.

\* The PYF-08-PU-L Sockets do not have release levers.

MY(S)

MYK

MYQ·MYH

Common Options (Order Separately)

Common Precautions

PYF-14-PU(-L)

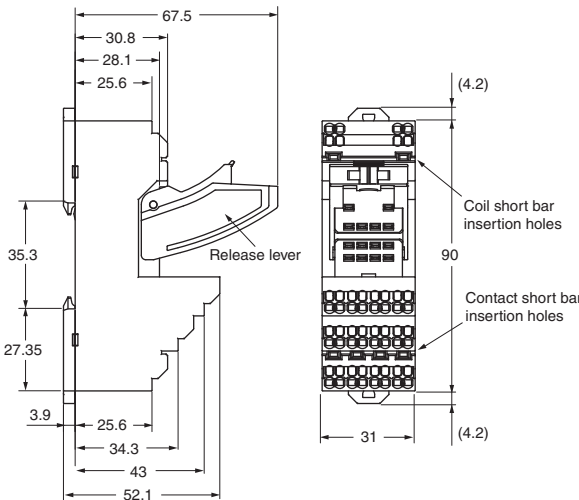
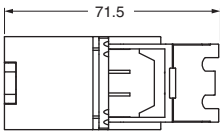

Terminal Arrangement/Internal Connection Diagram (Top View)

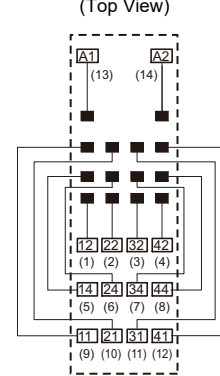

- Note:** The numbers in parentheses are traditionally used terminal numbers.

Mounting Hole Dimensions

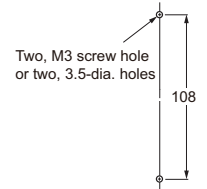

**Note:** Pull out the hooks to mount the Socket with screws.

\* The PYF-14-PU-L Sockets do not have release levers.

●Screwless terminal

PYF08S

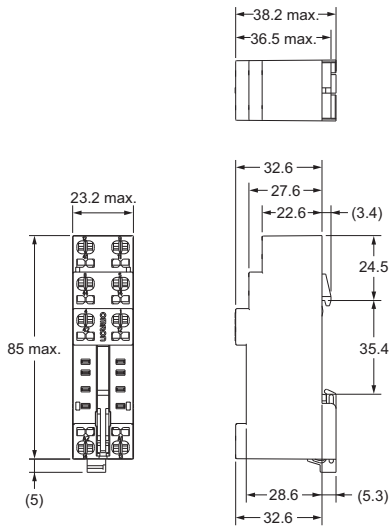
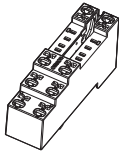

Terminal Arrangement/Internal Connection Diagram

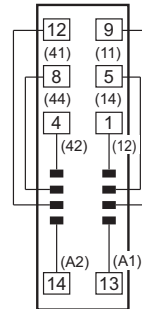

(Top View)

Note: The number shown in parentheses is the DIN standard.

PYF14S

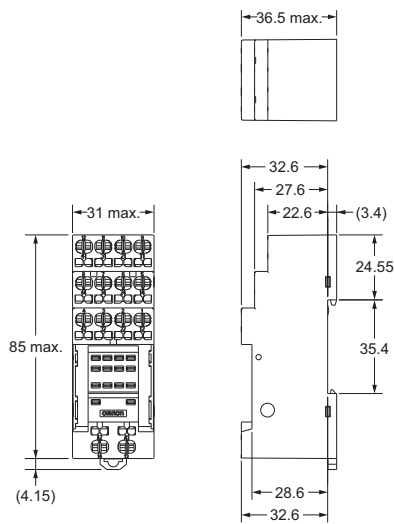
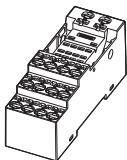

Terminal Arrangement/Internal Connection Diagram

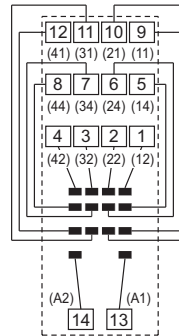

(Top View)

Note: The number shown in parentheses is the DIN standard.

MY-GS-R

MY(S)

MYK

MYQ-MYH

Common Options (Order Separately)

Common Precautions

# MY-GS/MY(S)/MYK/MYQ·MYH

MY-GS-R

## Front-connecting Sockets ●Screw terminal

### PYFZ-08

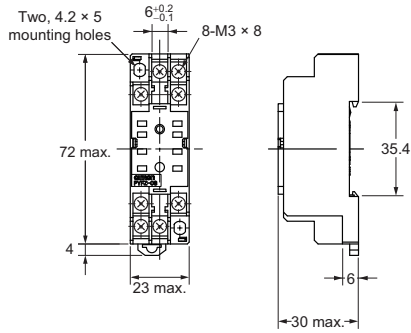

Terminal Arrangement/  
Internal Connection Diagram

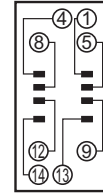

(Top View)

Mounting Hole Dimensions

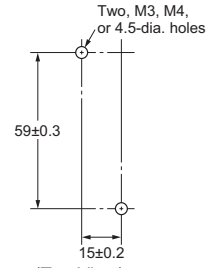

**Note:** Track mounting is also possible.

MY(S)

### PYFZ-08-E (Finger-protection structure)

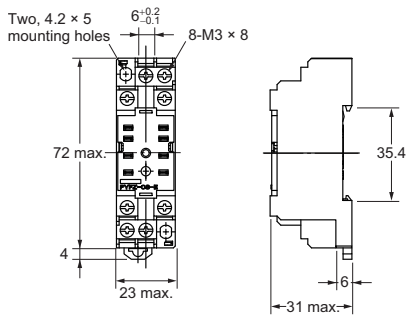

MYK

### PYF08A-N

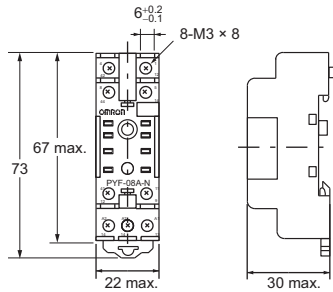

Terminal Arrangement/  
Internal Connections

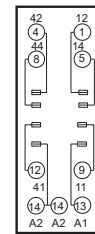

(Top View)

Mounting Hole Dimensions

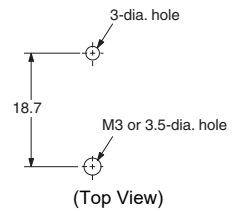

**Note:** Mounts to DIN Track.

MYQ·MYH

### PYF11A

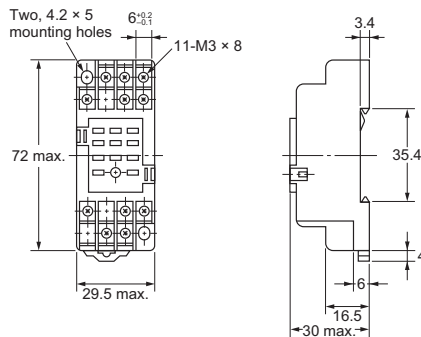
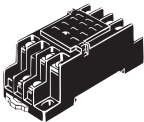

Terminal Arrangement/Internal  
Connection Diagram

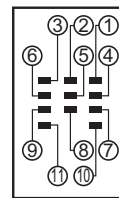

(Top View)

Mounting Hole Dimensions

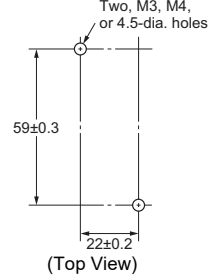

**Note:** Track mounting is also possible.

Common Options (Order Separately)

Common Precautions



PYFZ-14

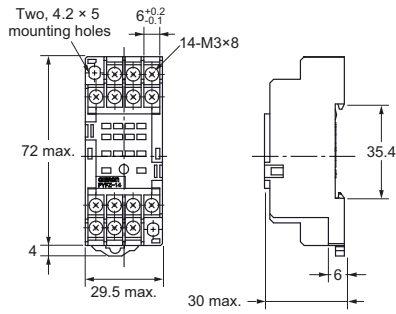

Terminal Arrangement/Internal Connection Diagram

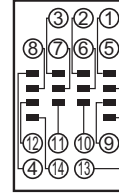

(Top View)

Mounting Hole Dimensions

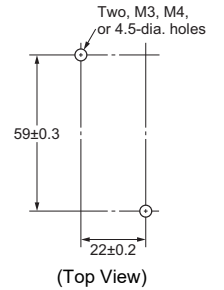

Note: Track mounting is also possible.

PYFZ-14-E  
(Finger-protection structure)

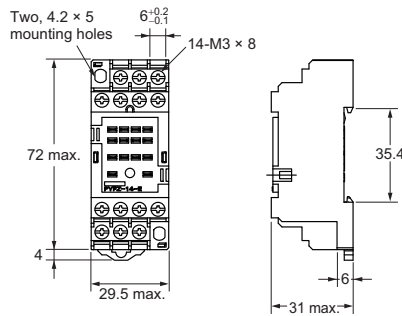

Terminal Arrangement/Internal Connections

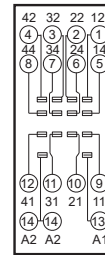

(Top View)

Mounting Hole Dimensions

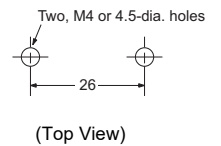

Note: Mounts to DIN Track.

PYF14A-N

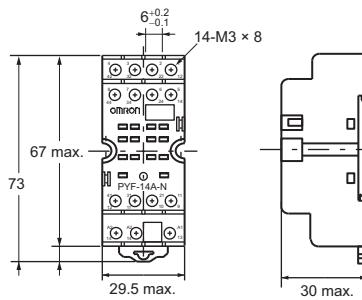

Terminal Arrangement/Internal Connection Diagram

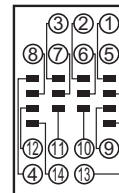

(Top View)

Mounting Hole Dimensions

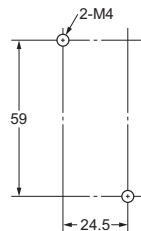

PYF14T

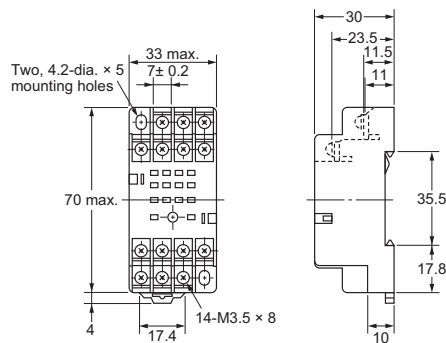
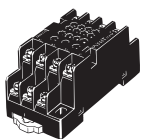

MY-GS-R

MY(S)

MYK

MYQ-MYH

Common Options (Order Separately)

Common Precautions

# MY-GS/MY(S)/MYK/MYQ·MYH

MY-GS-R

## PYF14-ESN-B

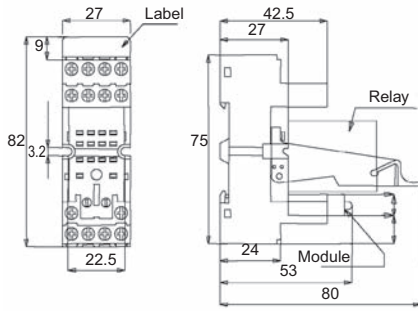

Terminal arrangement/  
Internal connections/  
mounting holes

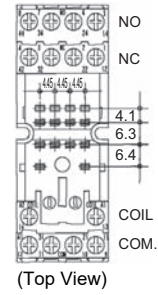

MY(S)

## PYF14-ESS-B

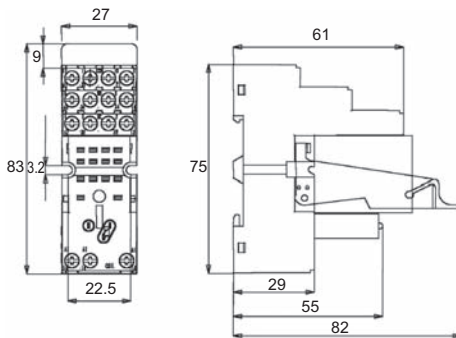

Terminal arrangement/  
Internal connections/  
mounting holes

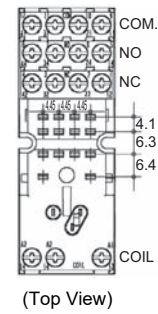

MYK

MYQ·MYH

Common Options (Order Separately)

Common Precautions

**Back-connecting Socket**  
**●Solder terminals**

**PY08**

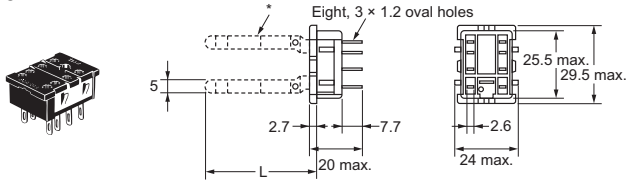

\*PY08-Y□ includes the portion indicated by broken line.

**Terminal Arrangement/Internal Connection Diagram**

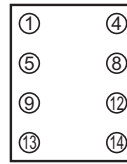

(Bottom View)

**Mounting Hole Dimensions**

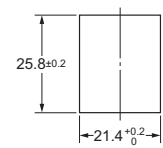

**PY11**

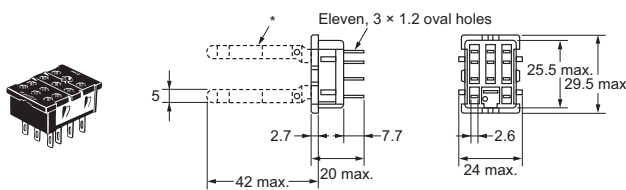

\*PY11-Y1 includes the portion indicated by broken line.

**Terminal Arrangement/Internal Connection Diagram**



(Bottom View)

**Mounting Hole Dimensions**

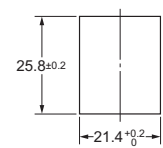

**PY14**  
**PY14-Y1**

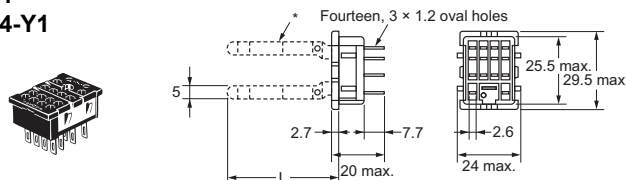

\*PY14-Y□ includes the portion indicated by broken line.

**Terminal Arrangement/Internal Connection Diagram**

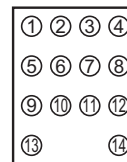

(Bottom View)

**Mounting Hole Dimensions**

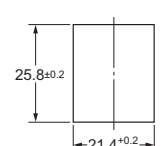

**●Wrapping terminals**

**PY08QN**  
**PY08QN2**

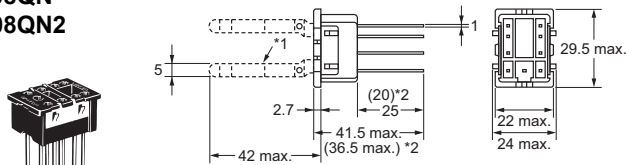

\*1. PY08QN(2)-Y1 includes the portion indicated by broken line.  
 \*2. Dimensions in parentheses are for PY08QN2(-Y1).

**Terminal Arrangement/Internal Connection Diagram**

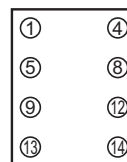

(Bottom View)

**Mounting Hole Dimensions**

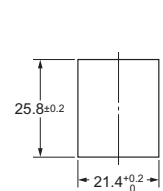

**PY11QN**  
**PY11QN2**

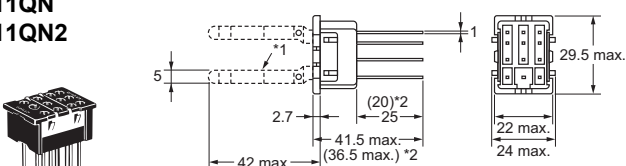

\*1. PY11QN(2)-Y1 includes the portion indicated by broken line.  
 \*2. Dimensions in parentheses are for PY11QN2(-Y1).

**Terminal Arrangement/Internal Connection Diagram**



(Bottom View)

**Mounting Hole Dimensions**

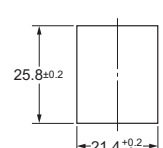

**PY14QN/PY14QN2**  
**PY14QN-Y1/PY14QN2-Y1**

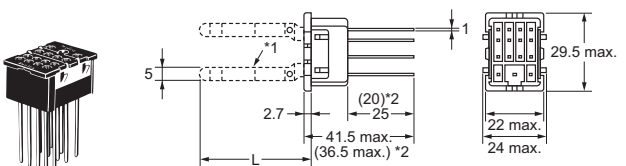

\*1. PY14QN-Y□ and PY14QN2-Y□ include the portion indicated by broken line.  
 \*2. Dimensions in parentheses are for PY14QN2(-Y□).

**Terminal Arrangement/Internal Connection Diagram**

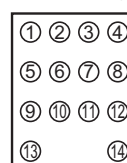

(Bottom View)

**Mounting Hole Dimensions**

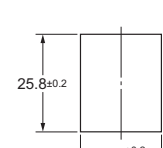

MY-GS-R

MY(S)

MYK

MYQ-MYH

Common Options (Order Separately)

Common Precautions

# MY-GS/MY(S)/MYK/MYQ·MYH

MY-GS-R

## ●PCB terminals

### PY08-02

• This is not a flux-tight structure. We recommend manual soldering for this product.

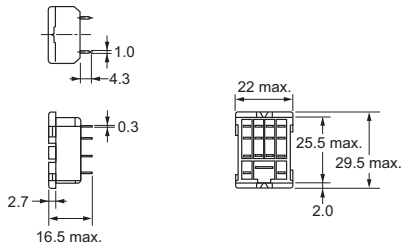

Terminal Arrangement/Internal Connection Diagram

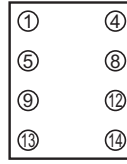

(Bottom View)

Mounting Hole and PCB Dimensions

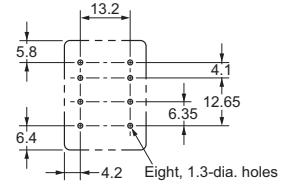

MY(S)

### PY11-02

• This is not a flux-tight structure. We recommend manual soldering for this product.

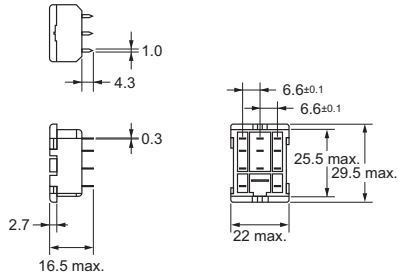
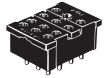

Terminal Arrangement/Internal Connection Diagram



(Bottom View)

Mounting Hole and PCB Dimensions

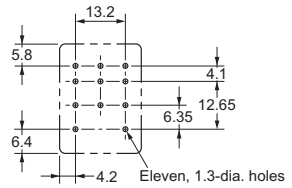

MYK

### PY14-02

• This is not a flux-tight structure. We recommend manual soldering for this product.

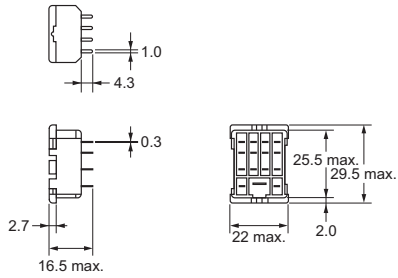

Terminal Arrangement/Internal Connection Diagram

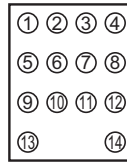

(Bottom View)

Mounting Hole and PCB Dimensions

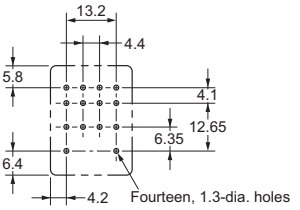

MYQ·MYH

## Socket Accessories

### ●Hold-down Clip

• PYC-A1  
1 set (2 pcs.)

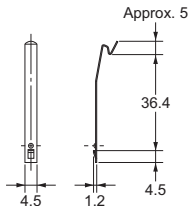

• PYC-E1  
1 set (2 pcs.)

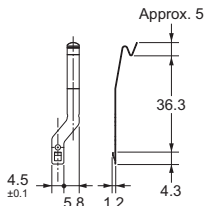

• PYC-P

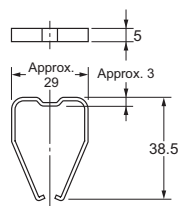

• PYC-S  
1 set (2 pcs.)

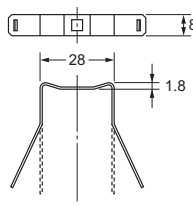

• Y92H-3  
1 set (2 pcs.)

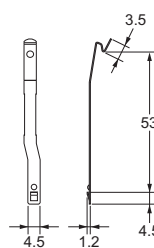

• PYC-1

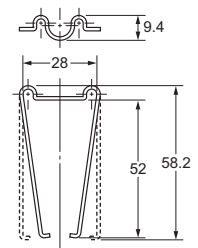

Common Options (Order Separately)

### ●Socket Mounting Plates

#### PYP-1

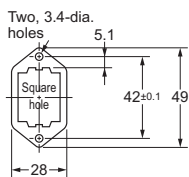

#### PYP-18

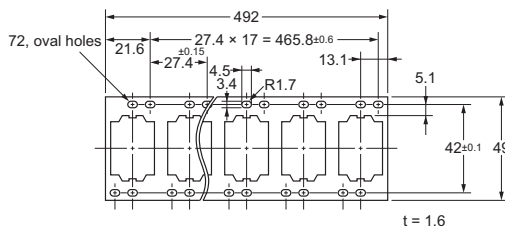

#### PYP-36

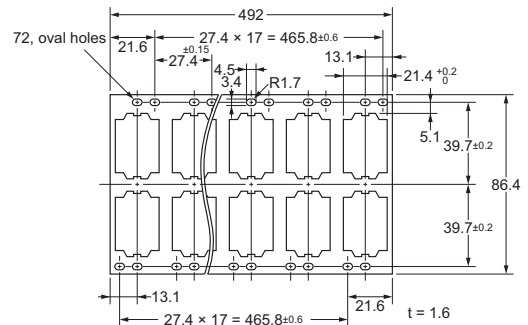

Common Precautions

●Accessories for DIN Track Mounting

DIN Tracks

PFP-100N

PFP-50N

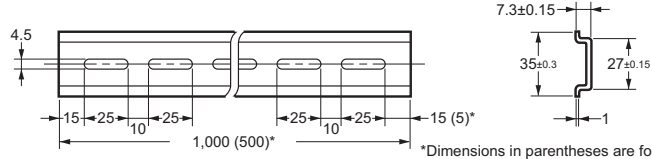
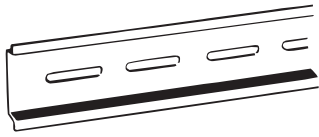

\*Dimensions in parentheses are for PFP-50N.

End Plate

PFP-M

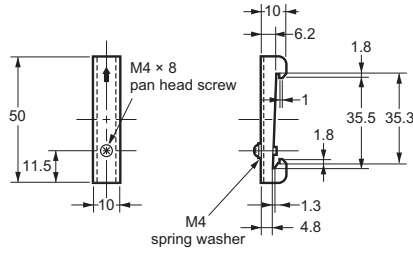

Spacer

PFP-S

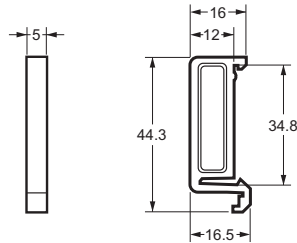
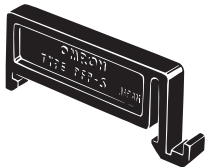

MY-GS-R

MY(S)

MYK

MYQ-MYH

Common Options (Order Separately)

Common Precautions



Safety Precautions

MY-GS-R

Relays



Be sure to read the *Safety Precautions for All Relays* in the website at the following URL:  
[http://www.ia.omron.com/product/cautions/36/safety\\_precautions.html](http://www.ia.omron.com/product/cautions/36/safety_precautions.html)

Warning Indications

 <b>WARNING</b>	Indicates a potentially hazardous situation which, if not avoided, may result in minor or moderate injury, or may result in serious injury or death. Additionally there may be significant property damage.
 <b>CAUTION</b>	Indicates a potentially hazardous situation which, if not avoided, may result in minor or moderate injury or in property damage.
<b>Precautions for Correct Use</b>	Supplementary comments on what to do or avoid doing, to prevent failure to operate, malfunction, or undesirable effects on product performance.

MY(S)

Meaning of Product Safety Symbols

	<ul style="list-style-type: none"> <li>● General caution</li> </ul> Indicates the possibility of non-specified general cautions, warnings, and danger.
	<ul style="list-style-type: none"> <li>● Electric shock caution</li> </ul> Used to warn of the risk of electric shock under specific conditions.
	<ul style="list-style-type: none"> <li>● High temperature caution</li> </ul> Indicates the possibility of injuries by high temperature under specific conditions.

MYK

 **CAUTION**

Do not touch terminal sections (i.e., current-carrying parts) while power is being supplied.

Also, always mount the terminal cover.

Touching current-carrying parts may result in electric shock.



Do not touch the main unit while power is being supplied or immediately after the power supply has been turned OFF. The main unit will be extremely hot and may result in burns.



MYQ·MYH

**Precautions for Correct Use**

● Handling

For models with a built-in operation indicator, models with a built-in diode, or high-sensitivity models, check the coil polarity when wiring and wire all connections correctly (DC operation).

● Installation

• There is no specifically required installation orientation, but make sure that the Relays are installed so that the contacts are not subjected to vibration or shock in their movement direction.

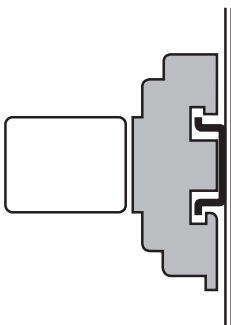

• Use two M3 screws to mount the case-surface mounting (MY□F) and tighten them securely. (Appropriate tightening torque: 0.98 N·m)

Common Options (Order Separately)

Common Precautions

● Relay Replacement

To replace the Relay, turn OFF the power supply to the load and Relay coil sides to prevent unintended operation and possible electrical shock.

● Applicable Sockets

Use only combinations of OMRON Relays and Sockets.

● Attaching and Removing Relay Hold-down Clips

When you attach a Hold-down Clip to or remove it from a Socket, wear gloves or take other measures to prevent injuring your fingers on the Hold-down Clip.

● Compliance with Electrical Appliances and Material Safety Act

- MY standard models comply with the Electrical Appliances and Material Safety Act.
- Always protect any exposed terminals (including Socket terminals) after wiring with insulation tubes or resin coating on PCBs.

Model	Number of poles	Operating Coil ratings	Contact ratings
MY	1 2 3	6 to 220 VAC 6 to 120 VDC	5 A, 200 VAC
	4*	6 to 110 VAC 6 to 120 VDC	3 A, 115 VAC

\*Under the Electrical Appliances and Material Safety Act, do not use the Type 4 model with a voltage that exceeds 150 VAC. However, this restriction can be ignored if compliance with the Electrical Appliances and Material Safety Act is not required.

● Miniature Power Relays: MY

Latching Levers

- Turn OFF the power supply when operating the latching lever. After you use the latching lever always return it to its original state.
- Do not use the latching lever as a switch.
- The latching lever can be used for 100 operations minimum.

About the Built-in Diode and CR Elements

The diode or CR element that are built into the Relay are designed to absorb the reverse voltage from the Relay coil. If a large surge in voltage is applied to the diode or CR element from an external source, the element will be destroyed.

If there is the possibility of large voltage surges that could be applied to the elements from an external source, take any necessary surge absorption measures.

Using Microloads with Infrequent Operation

If any standard MY-series Relays (e.g., MY4) are used infrequently to switch microloads, the contacts may become unstable and eventually result in failure contact. In this case, we recommend using the MY4Z-CBG Series, which has high contact reliability for microloads.

**●Latching Relays (MYK)**

- For applications that use a 200 VAC power supply, connect external resistors Rs and Rr to a 100 VAC Relay.

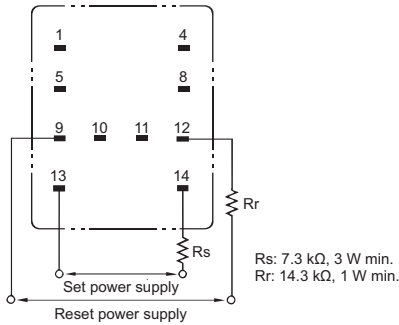

- Do not apply a voltage to the set and reset coils at the same time. If you apply the rated voltage to both coils simultaneously, the Relay will be set.
- The minimum pulse width in the performance column is the value for the following measurement conditions: an ambient temperature of 23°C with the rated operating voltage applied to the coil. Satisfactory performance may be unattainable due to decreased holding strength caused by changes in circuit conditions and ambient operating temperature, or due to changes caused by product aging. During actual use, apply a pulse width of the rated operating voltage suitable for the actual load to the coil and reset this at least once per year as a means of dealing with product aging.
- If the Relay is used in an environment with strong magnetic fields, the surrounding magnetic field can demagnetize the magnetic body and cause unintended operation. Therefore, do not use these Relays in environments with strong magnetic fields.

**●Hermetically Sealed Relays (MYH)**

**Relays with PCB Terminals**

When a Relay with PCB Terminals is mounted, a short-circuit can occur depending on the design of the PCB pattern because the Relay itself is made out of metal.

**Solution**

Refer to the external dimensions of the Relay and design the PCB pattern with enough space to prevent this problem.

**Application Environments**

Humid environments can cause insulation problems, which may result in short-circuiting or unintended operation.

**Solution**

Do not use these Relays in any environment where the Relay will come into contact with water vapor, condensation, or water droplets. This can reduce the surface tension of the terminal insulating beads and cause short-circuiting or unintended operation due to insulation problem.

**Optional Sockets (Order Separately)**

Be sure to read the *Safety Precautions for All Relays* in the website at the following URL: [http://www.ia.omron.com/product/cautions/36/safety\\_precautions.html](http://www.ia.omron.com/product/cautions/36/safety_precautions.html)

**Front-connecting Sockets**

**●Push-In Plus Terminal Sockets (PYF-08-PU(-L), PYF-14-PU(-L))**

Refer to *Safety Precautions* on the Push-In Plus Terminal Block Socket PYF-□□-PU/P2RF-□□-PU Data Sheet (Catalog No. SGFR-218).

**●Screwless Terminal Sockets (PYF08S, PYF14S)**

Refer to *Safety Precautions* on the Screwless Terminal Socket PYF□□S/P2RF-□□S Data Sheet (Catalog No. CDRR-011).

**●Screw Terminal Sockets (PYFZ-08(-E), PYF11A, PYFZ-14(-E), PYF-14T)**

Be sure to read the *Safety Precautions for All Relays, 4-2-1 Panel-mounting Sockets* and *4-2-2 Relay Removal Direction* of the website at the following URL: [http://www.ia.omron.com/product/cautions/36/safety\\_precautions.html](http://www.ia.omron.com/product/cautions/36/safety_precautions.html)

- Use the following tightening torque for screws during wiring.

Model	Tightening torque
PYFZ-08 PYFZ-14	0.78 to 1.18 N·m
PYFZ-08-E PYFZ-14-E	0.59 to 0.88 N·m * Use a No. 1 screwdriver.

- Use the following wire diameters as a guide for wiring. (Select the appropriate wire diameter for the current used.)

Model	Recommended wire diameter (mm <sup>2</sup> )	
PYFZ-08 PYFZ-14	Stranded wire	0.75 to 2.5 mm <sup>2</sup> AWG 18 to 14
	Solid wire	0.75 to 1.5 mm <sup>2</sup> AWG 18 to 16
PYFZ-08-E PYFZ-14-E	Stranded wire	0.75 to 2.5 mm <sup>2</sup> AWG 18 to 14
	Solid wire	0.75 to 1.5 mm <sup>2</sup> AWG 18 to 16

**Back-connecting Socket**

**●Solder Terminal Sockets (PY08(-Y1/-Y3), PY11(-Y1/-Y3))**

**●Wrapping Terminals Sockets (PY08QN(-Y1/-Y3), PY08QN2(-Y1/-Y3), PY11QN(-Y1), PY11QN2(-Y1))**

**●PCB Terminal Sockets (PY08-02, PY11-02)**

Be sure to read the *Safety Precautions for All Relays, 4-2-3 Back-connecting Sockets* and *4-2-5 Terminal Soldering* of the website at the following URL: [http://www.ia.omron.com/product/cautions/36/safety\\_precautions.html](http://www.ia.omron.com/product/cautions/36/safety_precautions.html)

**MY-GS-R**

**MEMO**

**MY(S)**

**MYK**

**MYQ-MYH**

**Common Options (Order Separately)**

**Common Precautions**



# Terms and Conditions Agreement

## Read and understand this catalog.

Please read and understand this catalog before purchasing the products. Please consult your OMRON representative if you have any questions or comments.

## Warranties.

- (a) Exclusive Warranty. Omron's exclusive warranty is that the Products will be free from defects in materials and workmanship for a period of twelve months from the date of sale by Omron (or such other period expressed in writing by Omron). Omron disclaims all other warranties, express or implied.
- (b) Limitations. OMRON MAKES NO WARRANTY OR REPRESENTATION, EXPRESS OR IMPLIED, ABOUT NON-INFRINGEMENT, MERCHANTABILITY OR FITNESS FOR A PARTICULAR PURPOSE OF THE PRODUCTS. BUYER ACKNOWLEDGES THAT IT ALONE HAS DETERMINED THAT THE PRODUCTS WILL SUITABLY MEET THE REQUIREMENTS OF THEIR INTENDED USE.

Omron further disclaims all warranties and responsibility of any type for claims or expenses based on infringement by the Products or otherwise of any intellectual property right. (c) Buyer Remedy. Omron's sole obligation hereunder shall be, at Omron's election, to (i) replace (in the form originally shipped with Buyer responsible for labor charges for removal or replacement thereof) the non-complying Product, (ii) repair the non-complying Product, or (iii) repay or credit Buyer an amount equal to the purchase price of the non-complying Product; provided that in no event shall Omron be responsible for warranty, repair, indemnity or any other claims or expenses regarding the Products unless Omron's analysis confirms that the Products were properly handled, stored, installed and maintained and not subject to contamination, abuse, misuse or inappropriate modification. Return of any Products by Buyer must be approved in writing by Omron before shipment. Omron Companies shall not be liable for the suitability or unsuitability or the results from the use of Products in combination with any electrical or electronic components, circuits, system assemblies or any other materials or substances or environments. Any advice, recommendations or information given orally or in writing, are not to be construed as an amendment or addition to the above warranty.

See <http://www.omron.com/global/> or contact your Omron representative for published information.

## Limitation on Liability: Etc.

OMRON COMPANIES SHALL NOT BE LIABLE FOR SPECIAL, INDIRECT, INCIDENTAL, OR CONSEQUENTIAL DAMAGES, LOSS OF PROFITS OR PRODUCTION OR COMMERCIAL LOSS IN ANY WAY CONNECTED WITH THE PRODUCTS, WHETHER SUCH CLAIM IS BASED IN CONTRACT, WARRANTY, NEGLIGENCE OR STRICT LIABILITY.

Further, in no event shall liability of Omron Companies exceed the individual price of the Product on which liability is asserted.

## Suitability of Use.

Omron Companies shall not be responsible for conformity with any standards, codes or regulations which apply to the combination of the Product in the Buyer's application or use of the Product. At Buyer's request, Omron will provide applicable third party certification documents identifying ratings and limitations of use which apply to the Product. This information by itself is not sufficient for a complete determination of the suitability of the Product in combination with the end product, machine, system, or other application or use. Buyer shall be solely responsible for determining appropriateness of the particular Product with respect to Buyer's application, product or system. Buyer shall take application responsibility in all cases.

NEVER USE THE PRODUCT FOR AN APPLICATION INVOLVING SERIOUS RISK TO LIFE OR PROPERTY OR IN LARGE QUANTITIES WITHOUT ENSURING THAT THE SYSTEM AS A WHOLE HAS BEEN DESIGNED TO ADDRESS THE RISKS, AND THAT THE OMRON PRODUCT(S) IS PROPERLY RATED AND INSTALLED FOR THE INTENDED USE WITHIN THE OVERALL EQUIPMENT OR SYSTEM.

## Programmable Products.

Omron Companies shall not be responsible for the user's programming of a programmable Product, or any consequence thereof.

## Performance Data.

Data presented in Omron Company websites, catalogs and other materials is provided as a guide for the user in determining suitability and does not constitute a warranty. It may represent the result of Omron's test conditions, and the user must correlate it to actual application requirements. Actual performance is subject to the Omron's Warranty and Limitations of Liability.

## Change in Specifications.

Product specifications and accessories may be changed at any time based on improvements and other reasons. It is our practice to change part numbers when published ratings or features are changed, or when significant construction changes are made. However, some specifications of the Product may be changed without any notice. When in doubt, special part numbers may be assigned to fix or establish key specifications for your application. Please consult with your Omron's representative at any time to confirm actual specifications of purchased Product.

## Errors and Omissions.

Information presented by Omron Companies has been checked and is believed to be accurate; however, no responsibility is assumed for clerical, typographical or proofreading errors or omissions.

**Note: Do not use this document to operate the Unit.**

**OMRON Corporation Industrial Automation Company**

**Kyoto, JAPAN**

**Contact : [www.ia.omron.com](http://www.ia.omron.com)**

**Regional Headquarters**

**OMRON EUROPE B.V.**

Wegalaan 67-69, 2132 JD Hoofddorp  
The Netherlands  
Tel: (31) 2356-81-300 Fax: (31) 2356-81-388

**OMRON ELECTRONICS LLC**

2895 Greenspoint Parkway, Suite 200  
Hoffman Estates, IL 60169 U.S.A.  
Tel: (1) 847-843-7900 Fax: (1) 847-843-7787

**OMRON ASIA PACIFIC PTE. LTD.**

438B Alexandra Road, #08-01/02 Alexandra  
Technopark, Singapore 119968  
Tel: (65) 6835-3011 Fax: (65) 6835-3011

**OMRON (CHINA) CO., LTD.**

Room 2211, Bank of China Tower,  
200 Yin Cheng Zhong Road,  
PuDong New Area, Shanghai, 200120, China  
Tel: (86) 21-6023-0333 Fax: (86) 21-5037-2388

**Authorized Distributor:**

©OMRON Corporation 2023-2024 All Rights Reserved.  
In the interest of product improvement,  
specifications are subject to change without notice.

**CSM\_1\_4**

**Cat. No. J268-E1-04 0524 (0323)**