

THORGEON

SENSORS

PIR MOTION SENSOR GEN2

02021

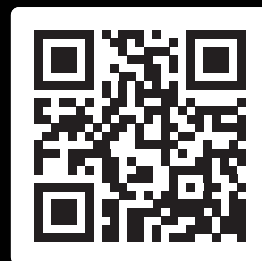

Scan me

www.thorgeon.com/02021

Manufactured in PRC



LED
POWER
300W

360°

4m

TIME

LUX

Hz
50-60

220-240V

2,2-4m

INDOOR

-20°C

+40°C

IP20

CE EAC UK CA 

THORGEON



www.thorgeon.com

SIA "ATTA-1", Daugavgrivas street 77,
Riga, Latvia, LV-1007



4751029894519

Developed in Latvia

Sensor utilizes the infrared energy from human as control-signal source and it can start the load at once when one enters detection field. It can identify day and night automatically. It is easy to install and used widely.

SPECIFICATION:

Power Sourcing: 220 -240V/AC
 Power Frequency: 50/60Hz
 Ambient Light: <3-2000LUX (adjustable)
 Time Delay: Min.10sec±3sec
 Max.7min±2min
 Rated Load: 1200W ☀
 300W ☾
 300W LED

Detection Range: 360°
 Detection Distance: 6m max(<24°C)
 Working Temperature: -20~+40°C
 Working Humidity: <93%RH
 Power Consumption: approx 0.5W
 Installation Height: 2.2-4m
 Detection Moving Speed: 0.6-1.5m/s

FUNCTION:

- Can identify day and night: The consumer can adjust working state in different ambient light. It can work in the daytime and at night when LUX knob is adjusted on the "sun" position (max). It can work in the ambient light less than 3LUX when it is adjusted on the "moon" position (min). As for the adjustment pattern, please refer to the testing pattern.
- Time-Delay is added continually: When it receives the second induction signals within the first induction, it will restart to time from the moment.

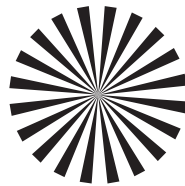



INSTALLATION ADVICE:

As the detector responds to changes in temperature, avoid the following situations:

- Avoid pointing the detector towards objects with highly reflective surfaces, such as mirrors etc.
- Avoid mounting the detector near heat sources, such as heating vents, air conditioning units, light etc.
- Avoid pointing the detector towards objects that may move in the wind, such as curtains, tall plants etc.



CONNECTION:

 WARNING	<p>Warning. Danger of death through electric shock!</p> <ul style="list-style-type: none"> • Must be installed by professional electrician. • Disconnect power source. • Cover or shield any adjacent live components. • Ensure device cannot be switched on. • Check power supply is disconnected.
	

- Please move the upper cover with anti-clockwise whirl as per the diagram on the right.
- Connect the power and the load according to the connection-wire diagram.
- Fix the bottom on the selected position with the inflated screw.
- Install back the upper cover on the sensor, then you could switch on the power and test it.

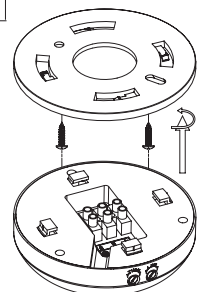

CONNECTION-WIRE DIAGRAM:

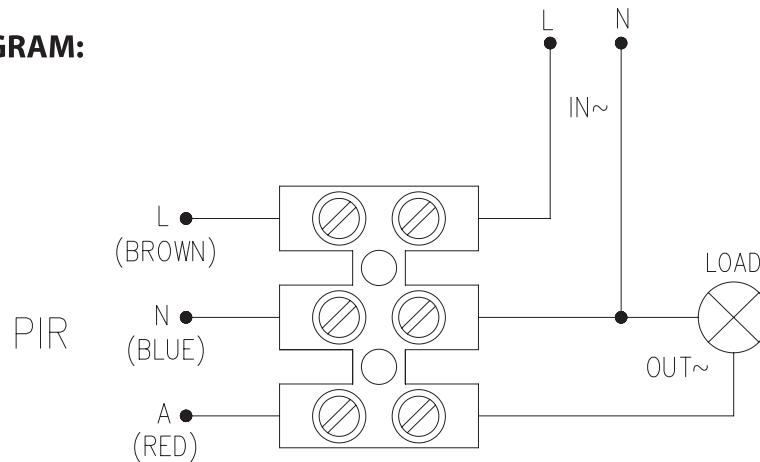

TEST:

- Turn the TIME knob anti-clockwise on the minimum (-). Turn the LUX knob anti-clockwise on the maximum (sun).
- Switch on the power; the sensor and its connected lamp will have no signal at the beginning. After Warm-up 30sec, the sensor can start work. If the sensor receives the induction signal, the lamp will turn on. While there is no another induction signal any more, the load should stop working within $10\text{sec} \pm 3\text{sec}$ and the lamp would turn off.
- Turn LUX knob clockwise on the minimum (moon). If the ambient light is more than 3LUX, the sensor would not work and the lamp stop working too. If the ambient light is less than 3LUX (darkness), the sensor would work. Under no induction signal condition, the sensor should stop working within $10\text{sec} \pm 3\text{sec}$.

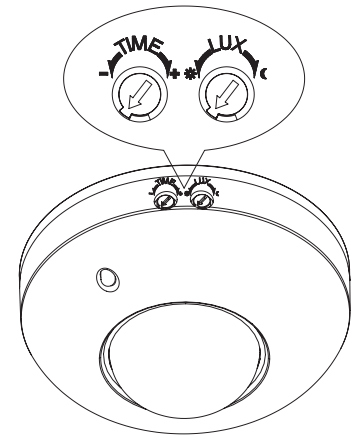

Note: when testing in daylight, please turn LUX knob to ☀ (SUN) position, otherwise the sensor lamp could not work! If the lamp is more than 60W, the distance between lamp and sensor should be 60cm at least.

SOME PROBLEM AND SOLVED WAY:

- The load does not work:
 - Please check if the connection of power source and load is correct.
 - Please check if the load is good.
 - Please check if the settings of working light correspond to ambient light.
- The sensitivity is poor:
 - Please check if there is any hindrance in front of the detector to affect it to receive the signals.
 - Please check if the ambient temperature is too high.
 - Please check if the induction signal source is in the detection field.
 - Please check if the installation height corresponds to the height required in the instruction.
 - Please check if the moving orientation is correct.
- The sensor can not shut off the load automatically:
 - Please check if there is continual signal in the detection field.
 - Please check if the time delay is set to the maximum position
 - Please check if the power corresponds to the instruction.