

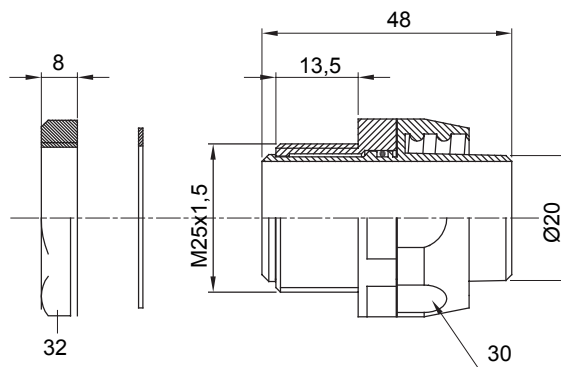

Straight and revolving coupling device for sheath with IP54 protection degree.

Colour	Black RAL 9005	IP degree	IP54
ISO pitch	M 25x1.5	Sheath Ø (mm)	20
Type	Revolving	Electrocod	210

### DIMENSIONAL



### TECHNICAL SYMBOLOGY

**IP**

IP54

### STANDARDS/APPROVALS

