

## KombiSIGN 50 / LED Bulb LED Bulb 230VAC YE



**Part No.:** 956.300.68

### MECHANICAL DATA

Height	41 mm
Diameter	29 mm
Materials	PA-GF PC
Housing colour	Black
Weight with packaging	14 g
Product weight	10 g

### ELECTRICAL DATA

Operating voltage	230V
Operating voltage type	AC
Operating voltage frequency	50Hz
Operating voltage tolerance	+/- 10%
Rated operational voltage	230 VAC
Rated operational current	15 mA
Rated inrush current	500 mA

### OPTICAL DATA

Light source	LED
Light colour	Yellow
Optical signal image	Permanent
Service life optical	50,000 h maximum
Lamp fitting/socket	BA15d

### APPROVAL DATA

WEEE	Yes
Conforms with ATEX-directive	No
Conforms with CCC	No
Conforms with FCC	No
Conforms with IC	No
EAC certificate available	No
Conforms with AS-I	No
ICAO Certification	No
Conforms with DNV	No
Conforms with RoHS CN	No



For additional installation and mounting information, refer to the appropriate user guide at [www.werma.com](http://www.werma.com). This printed copy is for information only and is subject to alteration.

KombiSIGN 50 / LED Bulb  
**LED Bulb 230VAC YE**

**DRAWING**

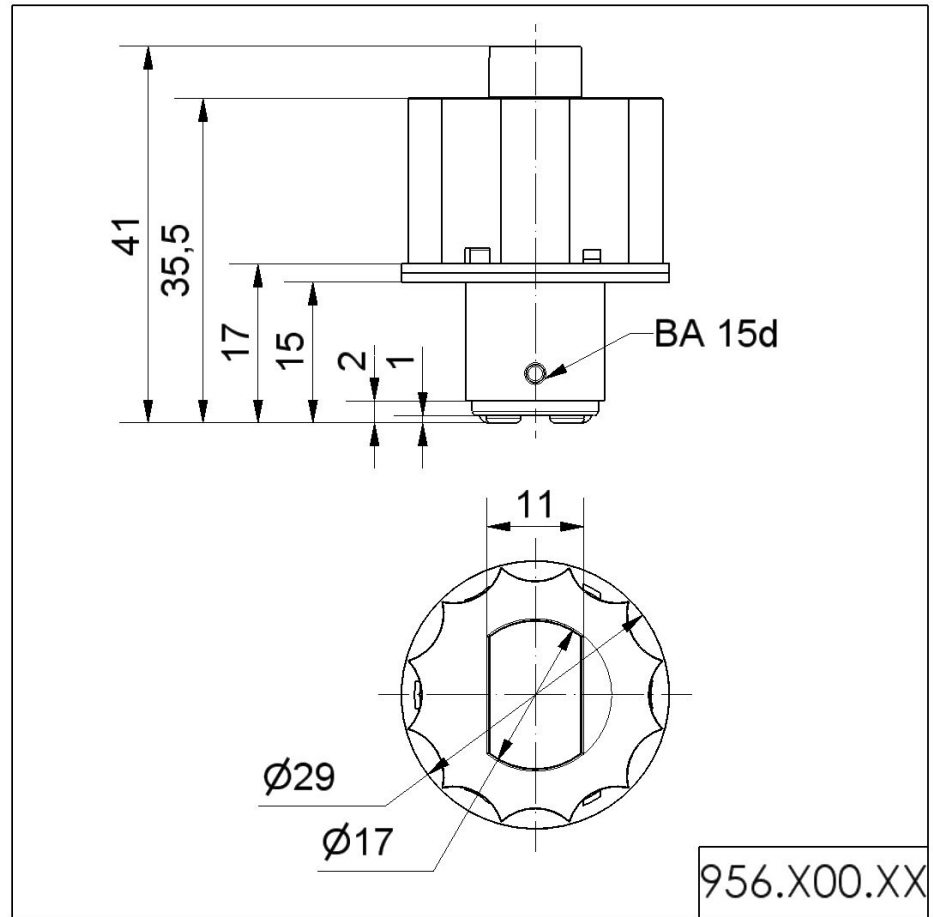

 For additional installation and mounting information, refer to the appropriate user guide at [www.werma.com](http://www.werma.com). This printed copy is for information only and is subject to alteration.