

High-Coded Guard Lock Safety Door Switch (For Gate) D41G

Prevent people from being trapped inside hazardous areas

- High-coded safety door switch effective in tamper protection
- Integrated door handle structure reduces guarding design time. Integrated handle's smooth operation enables quick emergency exit
- Switch can be unlocked to avoid being trapped inside when power supply is unavailable
- Complies with EN ISO 14119 (Type 4/High Coded), EN ISO 13849-1 (PLe)



* The actuator is sold separately.

For the most recent information on models that have been certified for safety standards, refer to your OMRON website.

Refer to *Safety Precautions* on page 28

Features

The D41G is a high-coded safety door switch in which the combination of the switch and actuator is fixed by pairing with more than 1,000 variations available. You can develop applications requiring door lock while minimizing defeat possibilities.

Reduce maintenance effort

Maintenance frequency due to door misalignment can be reduced.

The deformation of the door hinge due to machine vibration sometimes causes misalignment between the switch and the actuator, making it difficult to close the door.

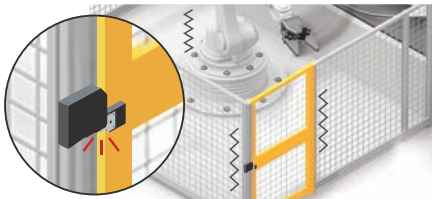

Maintenance is required when misalignment occurs.

Even if vibration distorts the door hinge, the wide key hole of the switch permits large misalignment tolerances in the approach of the actuator.

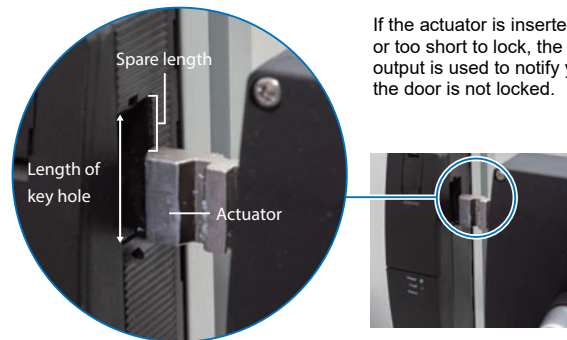

If the actuator is inserted too far or too short to lock, the auxiliary output is used to notify you that the door is not locked.

Exiting hazardous area (emergency exit)



Actuator with integrated emergency exit unit D41G-A2□-E1

- The actuator comes with door handles and other necessary parts, reducing the time required to design guards.
- The switch can be unlocked even when power is not supplied, preventing people from being trapped inside in an emergency situation.



Manual release allows manual unlock of the switch in a locked condition
Unnecessary locks can be prevented during setup.
(Refer to *Manual Release* on page 13.)

D41G

Model Number Structure

Model Number Legend

Safety Door Switch Switch

D41G - \square \square **D** \square - \square
(1) (2) (3) (4) (5) (6)

(1) Model

G: Guard Lock (For Gate)

(2) Coding level / Teaching limitation

1: High (Individual coding) / Teaching is not-repeatable

2: High (Individual coding) / Teaching is repeatable

(3) OSSD configuration

Y: Guard monitoring AND lock monitoring

Z: Only guard monitoring

(4) Diagnosis output

D: With diagnosis output (Auxiliary output)

(5) Lock and release

A: Power to unlock (Mechanical lock / Solenoid release)

G: Power to lock (Solenoid lock/ Mechanical release)

(6) Connection method

N2: M12 Connector

T1: Screw terminal (Conduit outlet M20)

Actuator

D41G - A \square \square - \square \square
(1) (2) (3) (4) (5)

(1) Model

G: Guard Lock (For Gate)

(2) Actuator type

A1: None door-handle (for sliding safety guards)

A2: With door-handle (for hinged or sliding safety guards)

(3) Handle position

L: Left (Actuator is installed on left of switch)

R: Right (Actuator is installed on right of switch)

(4) Emergency function

Blank: None function

E0: With emergency release tab (D41G-A1 only)

E1: With emergency exit unit (D41G-A2 only)

(5) Lock-out option (D41G-A2 only)

Blank: None option

T: With Lock-out tag







Ordering Information

List of Models

Switches

| Classification (Lock and Release) | Appearance | Coding level / Teaching limitation | OSSD configuration | Connection method | Model | |
|---|---|------------------------------------|--------------------------------------|--------------------------------------|----------------|--------------|
| Power to unlock (Mechanical lock/ Solenoid release) |  | High / Teaching is not-repeatable | Guard monitoring AND lock monitoring | Screw terminal | D41G-1YDA-T1 | |
| | | | | M12 Connector | D41G-1YDA-N2 | |
| | | High / Teaching is repeatable | Guard monitoring AND lock monitoring | Only guard monitoring | Screw terminal | D41G-2ZDA-T1 |
| | | | | Guard monitoring AND lock monitoring | M12 Connector | D41G-2YDA-N2 |
| Power to lock (Solenoid lock/ Mechanical release) | | | High / Teaching is repeatable | Guard monitoring AND lock monitoring | Screw terminal | D41G-2ZDG-T1 |
| | | | | | M12 Connector | D41G-2ZDG-N2 |
| | | | Only guard monitoring | Screw terminal | D41G-2YDG-T1 | |
| | | | | M12 Connector | D41G-2YDG-N2 | |

Actuators (Sold separately)

| Actuator type | Appearance | Handle position | Emergency function | Lock-out option | Model |
|------------------|---|-----------------|----------------------------|-------------------|--------------|
| With door-handle |  | Left | --- | --- | D41G-A2L |
| |  | | With emergency exit unit | --- | D41G-A2L-E1 |
| |  | | With emergency exit unit | With Lock-out tag | D41G-A2L-E1T |
| |  | Right | --- | --- | D41G-A2R |
| |  | | With emergency exit unit | --- | D41G-A2R-E1 |
| |  | | With emergency exit unit | With Lock-out tag | D41G-A2R-E1T |
| None door-handle |  | Left | --- | --- | D41G-A1L |
| |  | | With emergency release tab | --- | D41G-A1L-E0 |
| |  | Right | --- | --- | D41G-A1R |
| |  | | With emergency release tab | --- | D41G-A1R-E0 |

Accessory (Sold separately)

Connecting cables

| Appearance | Name | Features | Cable length | Model |
|---|--------------------------------------|---|--------------|---------------------|
|  | Connecting cables with M12 Connector | Connecting cables with M12 connector (female), 8-pole – 8 x 0.25 mm ² , straight, IP69 | 5 m | D41L-8P5-CFM12-905M |
| | | | 10 m | D41L-8P5-CFM12-910M |

D41G

Standards Certification

Directives

- Machinery Directive
- RE Directive
- RoHS Directive
- WEEE Directive



Dispose in accordance with applicable regulations.

Standards

- EN ISO 13849-1: PL e Category 4
- EN 60947-5-3
- EN 300 330
- IEC 61508
- EN ISO 14119

UL Certification

- UL508
- CAN/CSA C22.2 No.14

Regions where D41G can be used

The product can be used in Japan, the United States, Canada, EU member states, the United Kingdom, China, Australia, and New Zealand. The use in other countries may conflict with radio laws of the countries.

Ratings and Specifications

| Model | | D41G |
|--|--|--|
| Technical | | |
| Detection method | | RFID |
| Frequency band | | 125 kHz |
| Transmitter outputs | | -6 dBm max. |
| Interlock type (ISO 14119) | | Type 4 |
| Coded level (ISO 14119) | | High |
| Actuator *1 | | D41G-A1, D41G-A2 |
| Response time (ON to OFF) | | 100 ms max. |
| Response time (input) | | 1.5 ms max. |
| Risk time | | 200 ms max. |
| Startup time after power ON | | 4 s max. |
| Electrical | | |
| Supply voltage (Ue) | | 24 VDC -15%/+10% (stabilized PELV power supply) |
| Current consumption (Io) | | 0.05 A max. |
| Overvoltage category | | III |
| Pollution degree | | 3 |
| Operating current device with magnet switched on | | Average < 0.2 A Peak < 0.7 A/100 ms |
| Conditional short-circuit current | | 100 A |
| External device fuse rating | | Screws or cage clamps 4 A max. (UL508 compliant) M12 Connector 2 A max. |
| Safety input | Switching thresholds | -3 to 5 V (low) 15 to 30 V (high) |
| | Current consumption per input | 2 mA/24 V (typical) |
| | Accepted test pulse duration on input signal | 1.0 ms max. |
| | Test pulse interval | 100 ms min. |
| Safety output (OSSD) | Switching element | PNP type, short-circuit proof |
| | Utilization category | DC-13: 24 VDC (Ue)/0.25 A (Ie) |
| | Rated operating current (Ie) | Each 0.25 A max. |
| | OFF-state leakage current (Ir) | 0.5 mA max. |
| | Voltage Drop (Ud) | 4 V max. |
| | Cross-wire monitoring by device | Yes |
| | Test pulse duration | <0.5 ms |
| Auxiliary output | Test pulse interval | 1000 ms |
| | Switch element | PNP type, short-circuit proof |
| | Utilization category | DC-13: 24 VDC (Ue)/0.05 A (Ie) |
| | Rated operating current (Ie) | 0.05 A max. |
| Solenoid | Voltage drop (Ud) | 4 V max. |
| | Switching thresholds | -3 to 5 V (low) 15 to 30 V (high) |
| | Power consumption | 10 mA/24 V (typical) 20 mA (dynamic) |
| | Duty ratio solenoid (ED) | 100% |
| | Accepted test pulse duration on input signal | 5.0 ms max. |
| | Test pulse interval | 40 ms min. |
| Protection class | | III |
| Switching frequency | | 1 Hz max. |
| Rated insulation voltage (Ui) | | 32 VDC |
| Rated impulse withstand voltage (Uimp) | | 0.8 kV |
| Minimum operating current (Im) | | 0.5 mA |

D41G

| Model | D41G |
|------------------------------------|---|
| Mechanical | |
| Fixing screws | 2 × M6 |
| Tightening torque of fixing screws | 8 N·m |
| Tightening torque of cover screw | 0.7 to 1.0 N·m (Torx T10) |
| Latching force | 30 N |
| Holding force (Fzh) (min.) | 2,000 N |
| Operating speed | 0.2 m/s max. |
| Mechanical durability | 1,000,000 operations min. |
| Material | Fiberglass reinforced thermoplastic self-digestion (enclosure) |
| Weight | Unit: <510 g, Packaged: <600 g |
| Environmental | |
| Ambient operating temperature | -10 to 55°C |
| Ambient operating humidity | 93% max. (non-condensing, non-icing) |
| Degree of protection (IEC 60529) | IP66 and IP67 |
| Vibration resistance | 10 to 150 Hz, amplitude 0.35 mm |
| Shock resistance | 30 g/11 ms |
| Connection | |
| Series connection | 31 max. *2 |
| Cable lengths | 40 m max. (between switch and power supply) |
| Connection | Screw terminal or M12 connector |
| Cable type | Rigid single-wire or rigid multi-wire |
| Cable section | 0.25 mm ² min. 1.5 mm ² max. (including conductor ferrules) |
| Cable entry | M20 |

*1. D41G-A1 is suitable for sliding safety guards and D41G-A2 is for hinged or sliding safety guards.

*2. Refer to the *Connection* on page 10 for connection specifications with the Safety controller.

Safety classification information

| Interlocking function | |
|-----------------------|-----------------------------------|
| Standard | ISO 13849-1, IEC 61508, IEC 62061 |
| PL | e |
| DC | 99% |
| Safety Category | 4 |
| PFH | 1.9×10^{-9} |
| PFD | 1.6×10^{-4} |
| SIL | Suitable for SIL3 applications |
| Mission time | 20 years |

| Guard lock function | |
|---------------------|-----------------------------------|
| Standard | ISO 13849-1, IEC 61508, IEC 62061 |
| PL | d |
| DC | 99% |
| Safety Category | 2 |
| PFH | 1.0×10^{-8} |
| PFD | 8.9×10^{-4} |
| SIL | Suitable for SIL2 applications |
| Mission time | 20 years |

- Note:**
1. The actuation of the interlock must be compared with the external OSSD enabler. If a shut-down now occurs due to an unintentional unlocking this is detected by an external diagnostic.
 2. The safety consideration of the guard locking function only applies for monitored safety door switch D41G-□Y.
 3. If for a certain application the power-to-unlock type of a safety door switch cannot be used, then for this exception the power-to-lock type of a safety door switch can be used if additional safety measure need to be realized that have an equivalent safety level.
 4. The safety analysis of the guard locking function refers to the component safety door switch as part of the complete system. In the event of a fault resulting in the unlocking of the guard locking, this is detected by the safety outputs Y1/Y2 of the safety door switch switch off. When such a fault occurs the protection equipment may open immediately, just once, before the safe condition of the machine is reached. The system reaction of category 2 allows that a fault can occur between tests causing the loss of the safety function which is detected by the test.
 5. If multiple safety door switches are involved in the same safety function, the PFH values of the individual components must be added.

UL

Use isolated power supply only.

For use in NFPA 79 Applications only.

Adapters providing field wiring means are available from the manufacturer. Refer to manufacturers information.

FCC

This device complies with part 15 of the FCC Rules and Industry Canada license-exempt RSS standard(s).

Operation is subject to the following two conditions:

1. This device may not cause harmful interference, and
2. this device must accept any interference received, including interference that may cause undesired operation.

This device complies with the Nerve Stimulation Exposure Limits (ISED RSS-102) for direct touch operations. Changes or modifications not expressly approved by OMRON Corporation could void the user's authority to operate the equipment.

D41G

Structure and Nomenclature

Switch

D41G-□□D□-T1

D41G-□□D□-N2

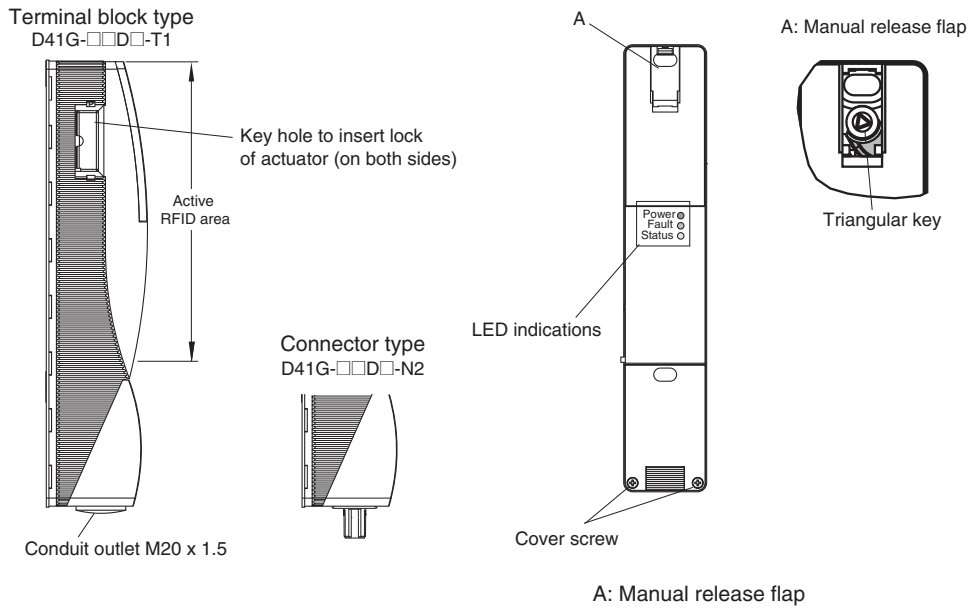

Actuator

With door-handle

D41G-A2□

D41G-A2□-E1

D41G-A2□-E1T

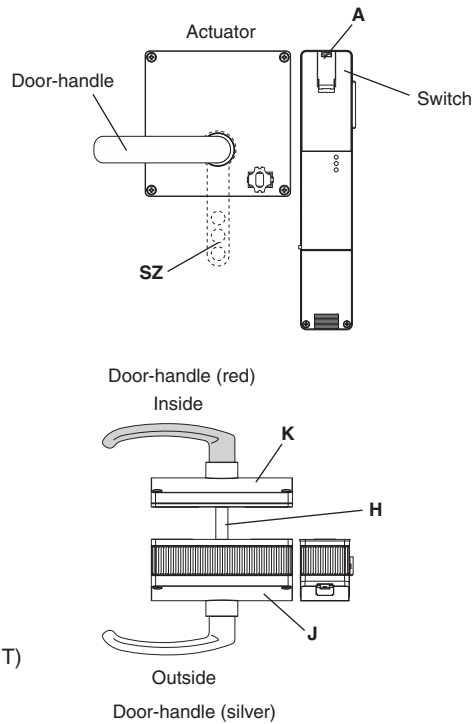

- A: Manual release flap
- J: Actuator unit with door-handle
- K: Emergency exit unit E1 (D41G-A2□-E1□)
- SZ: Lockout tag (optional, ordering D41G-A2□-E1T)
- H: Square rod (D41G-A2□-E1□)

Actuator

None door-handle

D41G-A1□

D41G-A1□-E0

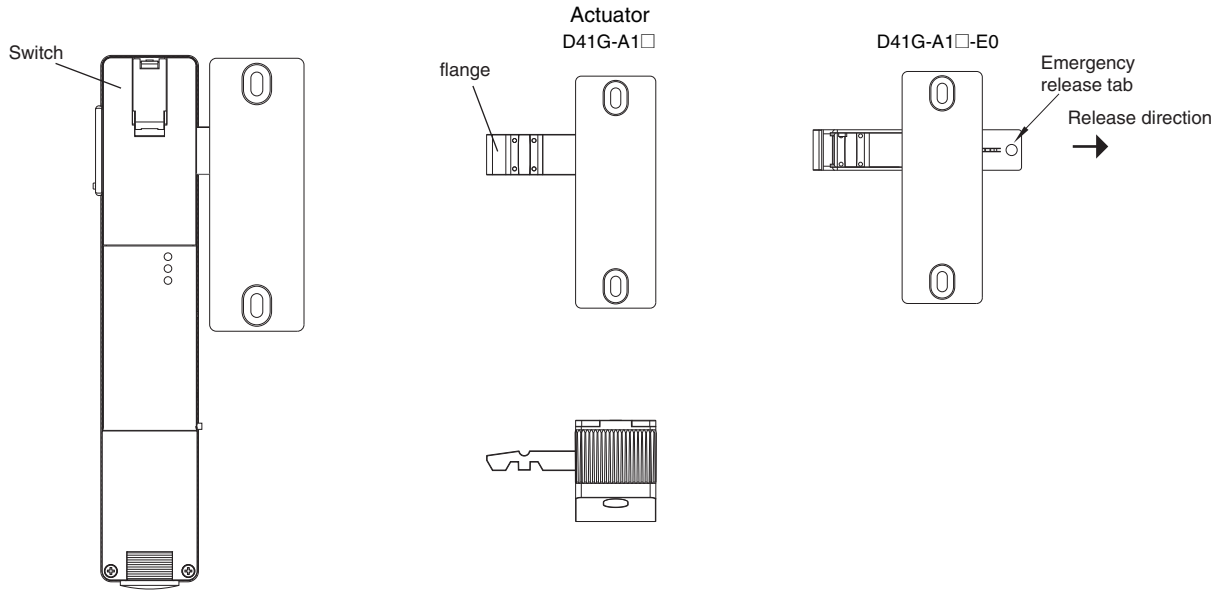

D41G

Connection

Pin assignment

| Function | | Pin assignment | Color code of the OMRON's connector D41L-8P5-CFM12-9□□M |
|----------|------------------|----------------|---|
| 24 V | U _e | 1 | WHITE |
| X1 | Safety input 1 | 2 | BROWN |
| GND | GND | 3 | GREEN |
| Y1 | Safety output 1 | 4 | YELLOW |
| OUT | Auxiliary output | 5 | GRAY |
| X2 | Safety input 2 | 6 | PINK |
| Y2 | Safety output 2 | 7 | BLUE |
| IN | Solenoid control | 8 | RED |

Terminal block (D41G-□□D□-T1)

| | | | | |
|-----|-----|----|----|-----|
| 24V | 24V | X1 | X2 | IN |
| | | | | |
| GND | | Y1 | Y2 | OUT |

Connector (D41G-□□D□-N2)

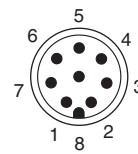

The cable entry is realized by a metric M20 gland. This gland must be measured by the user so that it is suitable for the cable used. A cable gland with strain relief and suitable IP protection class must be used. Length X of the cable at terminals: 8.0 mm (for screw terminals of -T1)

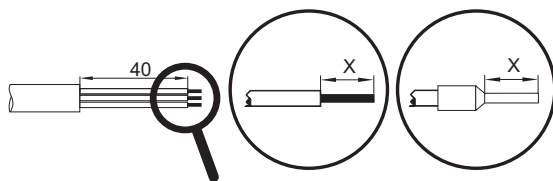

Wiring Example

The application examples shown are suggestions. However, these do not exempt the user from carefully checking whether the safety door switch and its set up are suitable for the individual application.

The power supply for the safety door switch must provide protection against permanent overvoltage. To that effect, stabilized PELV supply units must be used. The safety outputs (OSSD) can be directly connected in the safety circuit of the control system. For applications of PL e / safety category 4 in accordance with ISO 13849-1, the safety outputs (OSSD) of safety door switch or safety door switch of the chain must be connected to a safety controller or safety relay unit of the same Safety Category. Inductive loads (e.g. contactors, relays, etc.) are to be provided with suitable interference suppression circuitry.

If the safety door switch is wired to relays or to non-safety relevant control components, a new risk analysis must be carried out.

If the safety door switch is connected to the safety input of a safety controller or safety relay unit, the controller must have a dual-channel monitoring time of at least 100 ms and the accepted test pulse duration of at least 1 ms (except when connected to the NX-SL/SI). Also, the cross-wire-short monitoring function must be disabled.

Wiring example to connect a safety controller

When connecting multiple safety door switches in series, apply 24 VDC to safety inputs X1 and X2 on the Nth unit, as shown in the figure below. Connect safety outputs Y1 and Y2 to safety inputs X1 and X2 of the following safety door switch.

Connect safety outputs Y1 and Y2 of the first unit to the safety controller or safety relay unit.



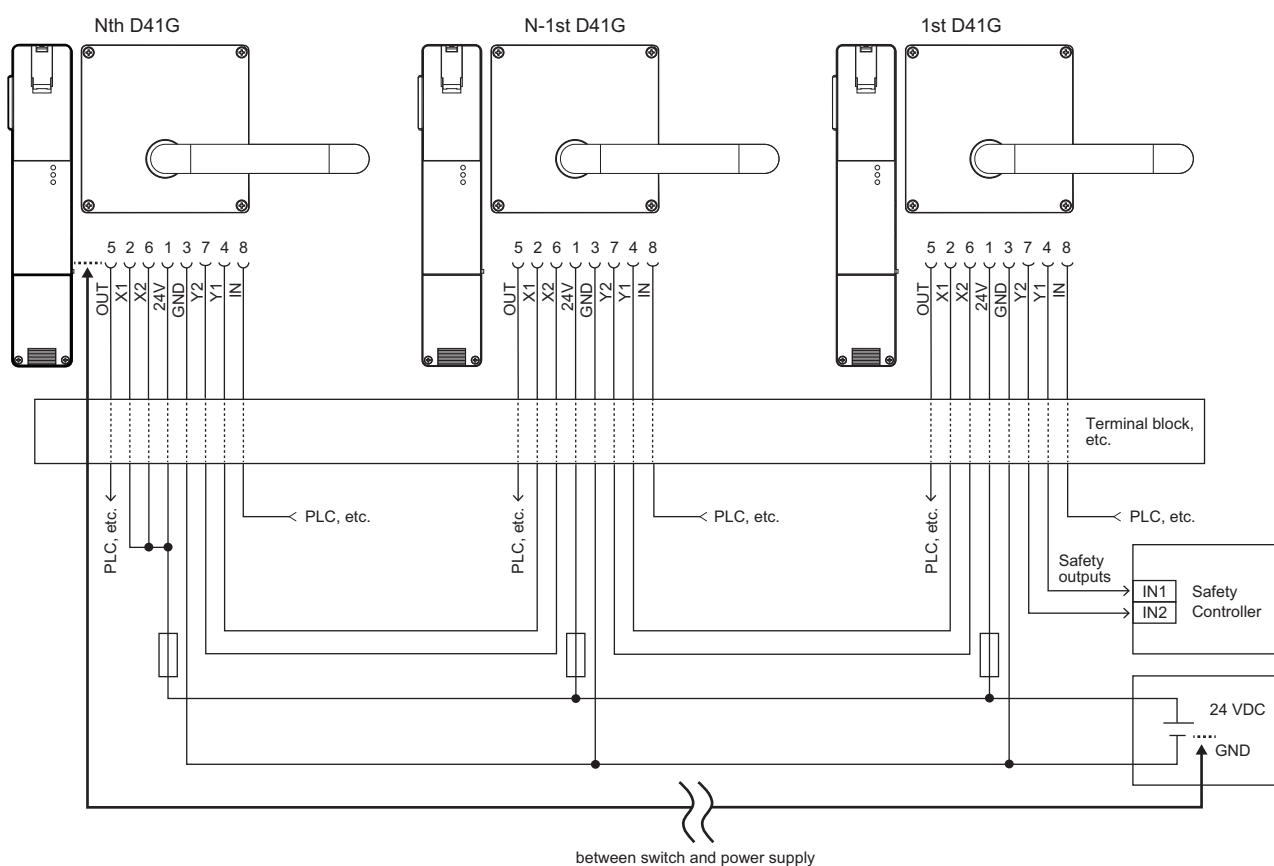

Connect the auxiliary output to the PLC, etc.

When connecting a single safety door switch to the safety controller or safety relay unit, apply 24 VDC to safety inputs X1 and X2 in the same manner as the Nth unit shown below, and then connect safety outputs Y1 and Y2 to the safety controller or safety relay unit.





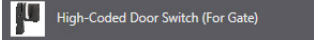
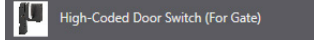
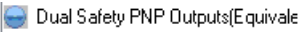
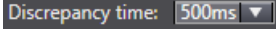

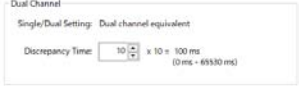
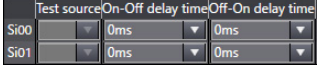
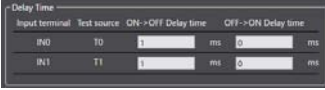
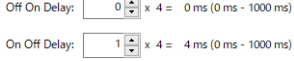
Note: The cable length between the switch and power supply must not exceed 40 m.

Safety controller settings

| OMRON's safety controller | | NX-SL and NX-SI  | GI-SMD/SID  | G9SP  |
|---------------------------|---------------------------|---|---|---|
| Input device setting | Input device | High-Coded Door Switch (For Gate)  | High-Coded Door Switch (For Gate)  | Dual Safety Semiconductor Output (Equivalent)  |
| | Discrepancy time | Set discrepancy time to 100 ms or more NX-Series Safety Control Unit User's Manual Refer to the Dual Channel Evaluation in Cat. No.Z930. Example (Default value when "High-Coded Door Switch (For Gate)" is selected)  | Set discrepancy time to 100 ms or more GI-S series Safety I/O Terminal User's Manual Refer to the Dual Channel Evaluation in Cat. No.Z400. Example (Default value when "High-Coded Door Switch (For Gate)" is selected)  | Set discrepancy time to 0 (disabled) or 100 ms or more G9SP series Safety Controller User's Manual Refer to the Dual Channel Evaluation in Cat. No.Z922. Example  |
| | Filtering out test pulses | No need to set input filter NX-Series Safety Control Unit User's Manual Refer to the Input Filters in Cat. No.Z930. Example (Default value when "High-Coded Door Switch (For Gate)" is selected)  | Set input filter ON->OFF delay time to 1 ms or more GI-S series Safety I/O Terminal User's Manual Refer to the Input Filter Function in Cat. No.Z400. Example (Default value when "High-Coded Door Switch (For Gate)" is selected)  | Set input filter OFF delay time to 1 ms or more G9SP series Safety Controller User's Manual Refer to the Input Filters in Cat. No.Z922. Example  |

Note: The ON → OFF delay time affects the response time (safety reaction time) of the system. Add the setting value to the system response time in each controller. For details on calculating the response time, refer to the manual of each controller.

Combination with a safety relay unit

| OMRON's safety relay unit | | G9SA  | G9SE  | G9SB  | G9SX  |
|---------------------------|------|---|---|--|---|
| Input device | D41G | Connectable | Connectable | Connectable | Connectable |

* Refer to the instruction manual or user's manual of each product for how to extend the wiring.

Manual Release

For the machine set up, the safety door switch can be unlocked in a de-energized condition. After opening of the manual release cover "A" (refer to image *Switch* on page 8), the triangular key must be turned clockwise to bring the blocking bolt in unlocking condition. The normal locking function is only restored after the triangular key has been returned to its original position. After being put into operation, the manual release must be secured by installing the seal, which is included in with the safety door switch.

Component ready
for operation

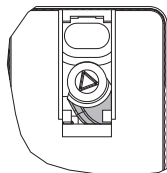

Component not ready
for operation

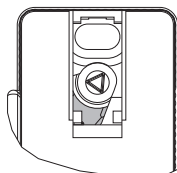

D41G

Teaching

The D41G will require the following teaching procedure to write individual actuator information (code).

Saving individual actuator information for identification to the switch through the teaching procedure is called "individual coding".

1. Keep the actuator away from the detection range and switch the safety door switch's voltage supply off and back on.
2. Introduce the actuator in the detection range. The teach-in procedure is signaled at the safety door switch, green LED off, red LED on, yellow LED flashes (1 Hz).
3. After 10 seconds, the yellow LED gives brief cyclic flashes (3 Hz). Switch off the supply voltage of the safety door switch. (If the voltage is not switched off within 5 minutes, the safety door switch cancels the teach-in procedure and signals a false actuator by 5 red flashes).
4. Switch the supply voltage back on. The actuator must be detected once more in order to activate the taught actuator code. In this way, the activated code is definitively saved.

For ordering suffix D41G-1, the executed allocation of safety interlock and actuator is irreversible.

When the above procedure is attempted with a D41G-1 which already completed teaching, the teaching procedure will not start.

For ordering suffix D41G-2, the teach-in procedure for a new actuator can be repeated an unlimited number of times. When a new actuator is taught, the code, which was applicable until that moment, becomes invalid. Subsequent to that, the safety outputs (OSSD) will be disabled for ten minutes, thus providing for an increased protection against intentional tampering.

The green LED will flash until the expiration of the time (10 minutes) of the enabling inhibit and the detection of the new actuator. In case of power failure during the lapse of time, the 10-minutes tampering protection time will restart.

When the above procedure is attempted with a combination of D41G-2 and actuator which already completed teaching, the teaching procedure will not start.

The D41G-A Actuator can be taught an unlimited number of times. This allows the actuator taught by the D41G-1 to be taught again by the D41G-2 with no teaching limitation instead of the D41G-1 with teaching limitation.

Operating Principle

Magnet control

In the power-to-unlock version of the D41G, the safety door switch is unlocked when the Solenoid Control signal (= 24 V) is set.
 In the power-to-lock version of the D41G, the safety door switch is locked when the Solenoid Control signal (= 24 V) is set.

If the risk analysis indicates the use of a monitored interlock then a variant (D41G-□Y) with the monitored interlock is to be used, labelled with the symbol (□Y).

The actuator monitoring variant (D41G-□Z) is a safety door switch with an interlock function for process protection.

Mode of operation of the safety outputs

In the D41G-□Y, the unlocking of the safety door switch causes the safety outputs (OSSD) to be disabled. The unlocked guard door can be relocked as long as the actuator is inserted in the D41G safety door switch; in that case, the safety outputs are re-enabled. The guard door must not be opened.

In the D41G-□Z, the opening of the guard door causes the safety outputs to be disabled.

Safety door switch with auxiliary output

The auxiliary output OUT can be used for central visualization of operating states or control functions, e.g. in a PLC.
 The auxiliary output is not a safety-related output.

Behavior of the diagnostic output

(Example: power-to-unlock version)

Input signal magnet control

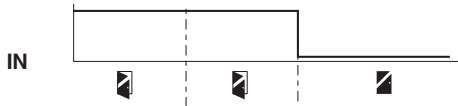

Key

- Guard door open
- Guard door closed
- Unlock guard door
- Guard door locked
- Locking time: 150 ... 250 ms, typically 200 ms
- Guard door not locked or fault

Normal sequence, door was locked

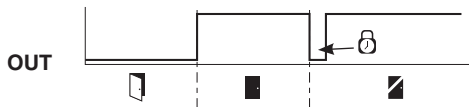

Door could not be locked or fault

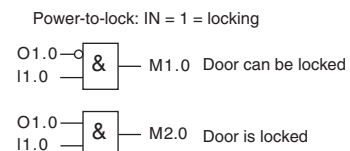
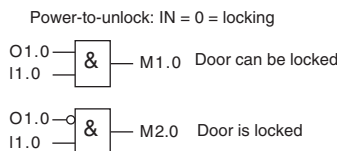
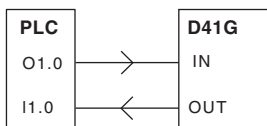
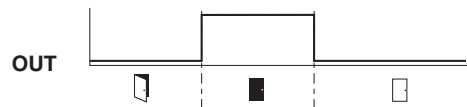

Diagnostic Functions

Diagnostic LEDs

The safety door switch indicates the operating condition and faults by means of three-color LEDs located in the front surface of the safety door switch.

- Green (Power): Supply voltage on
- Yellow (Status): Operating condition
- Red (Fault): Error (refer to Table 2)

Table 1: Diagnostic information for the safety switch

| System condition | Solenoid control (IN) | | LED | | | Safety outputs Y1, Y2 | | Auxiliary output OUT |
|--|-----------------------|---------------|---------|------------|---------|-----------------------|---------|----------------------|
| | Power-to-unlock | Power-to-lock | Green | Red | Yellow | D41G-□Y | D41G-□Z | |
| Door open | 24 V (0 V) | 0 V (24 V) | On | Off | Off | 0 V | 0 V | 0 V |
| Door closed, actuator not inserted | 24 V | 0 V | On | Off | Off | 0 V | 0 V | 0 V |
| Door closed, actuator inserted, not locked | 24 V | 0 V | On | Off | Flashes | 0 V | 24 V | 24 V |
| Door closed, actuator inserted, interlocking blocked | 0 V | 24 V | On | Off | Flashes | 0 V | 24 V | 0 V |
| Guard closed, actuator inserted and locked | 0 V | 24 V | On | Off | On | 24 V | 24 V | 24 V |
| Error warning (*1) safety door switch locked | 0 V | 24 V | On | Flashes *2 | On | 24 V *1 | 24 V *1 | 0 V |
| Error | 0 V (24 V) | 24 V (0 V) | On | Flashes *2 | Off | 0 V | 0 V | 0 V |
| Teach-in procedure actuator started | --- | --- | Off | On | Flashes | 0 V | 0 V | 0 V |
| Only D41G-2: Tampering protection time *3 | --- | --- | Flashes | Off | Off | 0 V | 0 V | 0 V |

*1. Unless error (warning) causes are eliminated within 30 minutes, the safety outputs are disabled after being enabled for 30 minutes.

*2. Refer to *Table 2: Error message/LED indication (red)*.

*3. Refer to *Teaching* on page 14.

Table 2: Error message/LED indication (red)

| Flash codes (Red) | Designation | Autonomous switch-off after | Error cause |
|-------------------|--|-----------------------------|---|
| 1 flash pulse | Error (warning) at output Y1 | 30 min | Fault in output test or voltage at output Y1 |
| 2 flash pulses | Error (warning) at output Y2 | 30 min | Fault in output test or voltage at output Y2 |
| 3 flash pulses | Error (warning) cross-wire short | 30 min | Cross-wire short between the output cables or fault at both outputs |
| 4 flash pulses | Error (warning) temperature too high | 30 min | The temperature measurement reveals an internal temperature that is too high |
| 5 flash pulses | Actuator fault | 0 min | Incorrect or defective actuator |
| 6 flash pulses | Error actuator combination | 0 min | An invalid combination of actuators was detected (blocking bolt detection or tamper attempt). |
| Continuous red | Internal fault / overvoltage or undervoltage fault | 0 min | Device defective / supply voltage not within specifications |

Actuator

Introduction

D41G-A

Mounting of the safety door switch and the actuator

Refer to the D41G actuator's Quick Installation Manual for the corresponding actuator.

The actuator must be permanently fitted to the guard doors and protected against displacement by suitable measures (tamper-proof screws, gluing, drilling of the screw heads).

Destination and Use

D41G-A2

In conjunction with the safety door switch D41G the actuator is suitable for hinged and sliding guard doors. The guard door can be opened and closed from outside by turning the door-handle.

The actuator is pulled into the actuator unit by a spring. The actuator unit with emergency exit is used to open the guard door inside the hazardous area. By actuating the emergency exit, the guard door can be opened from within the hazardous area without the need for unlocking the safety door switch D41G. The guard door cannot be locked from inside. On accessible protective equipment, the lockout tag prevents persons from being inadvertently being trapped. When entering the hazardous area, each member of the operating or service team fixes a lock to the lockout tag to prevent the locking of the guard door and therefore any inadvertent machine start.

Holding force F_{zh}
- mounting outside 2,000 N

D41G-A1

Actuators D41G-A1 is the preferred choice for use on sliding guard doors.

Actuator D41G-A1-E0 only suitable for the safety door switch D41G with concealed installation.

On the actuator with emergency exit, D41G-A1-E0, pulling the emergency release tab in the direction of arrow (see diagram) unlocks the D41G safety door switch whereupon the guard system can be opened.

When the guard door is closed, it is immediately re-locked. The autonomous, spring-loaded return of the unlocking mechanism, which is installed by the builder, must be guaranteed.

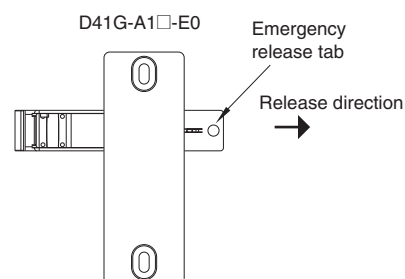

D41G

Dimensions

(Unit: mm)

Switches

D41G-□□D□-T1

D41G-□□D□-N2



Terminal block type
D41G-□□D□-T1

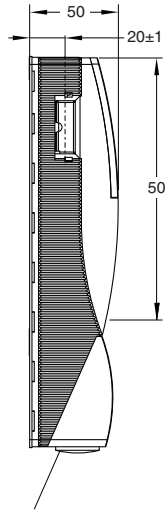

Conduit outlet M12

Connector type
D41G-□□D□-N2

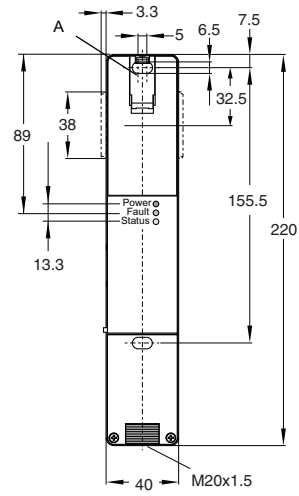
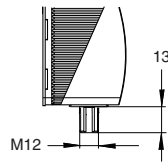

A: Manual release

Actuator (Sold separately)

With door-handle

D41G-A2□

D41G-A2□-E1

D41G-A2□-E1T



ex. D41G-A2L-E1T (For left) *

Mounting outside

Safety door switch D41G with actuator unit mounted outside the hazardous area

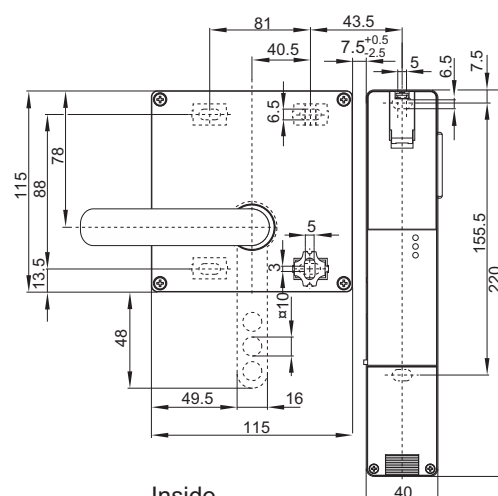

Inside

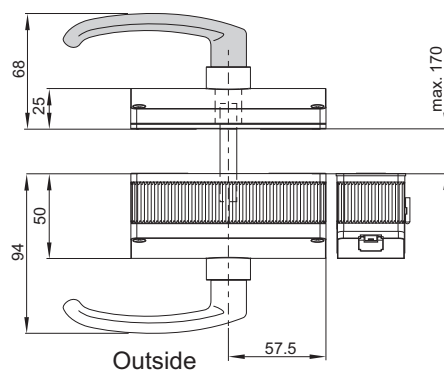

Outside

Interior view: Emergency exit unit

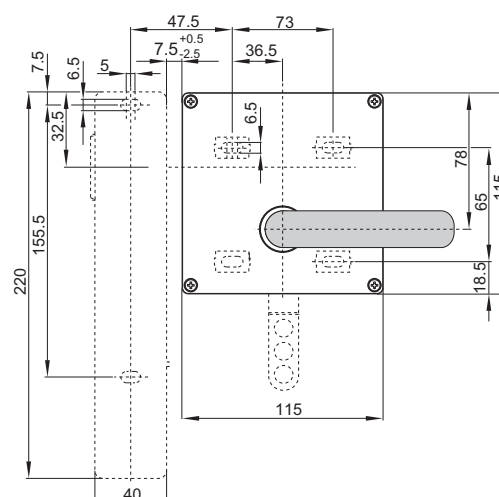

* The D41G-A2□ (without -E1□) does not come with an inside handle.

* The above shows the model for left.

The locking part position of the D41G-A2R (-E1□) for a right door is reversed.

D41G

None door-handle D41G-A1□



For right (D41G-A1R)

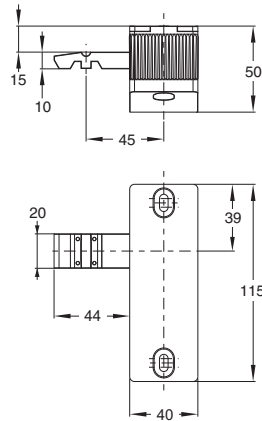

None door-handle (with emergency release tab) D41G-A1□-E0



For right (D41G-A1R-E0)

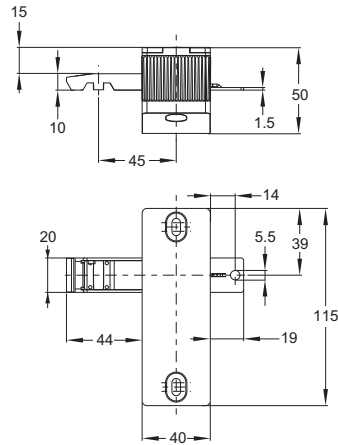

Example of mounting actuator D41G-□□□□-□□+D41G-A1□(-□)



For right (D41G-A1R)

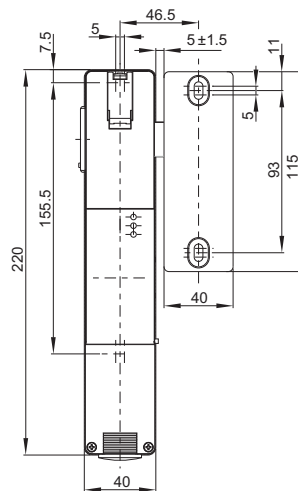

* The above shows the model for right. The locking part position of the D41G-A1L (-E0) for left is reversed.

Mounting

For fitting the safety door switch, two mounting holes for M6 screws with washers (washers included in delivery) are provided (tightening torque: 8 N·m). The safety door switch must not be used as a door stopper.

Any mounting position. The mounting position, however, must be chosen so that the ingress of dirt and soiling in the used opening is avoided. The unused actuator opening must be sealed by means of the dust-proof cover (included in delivery).

Minimum distance between two safety door switches

as well as other systems with same frequency (125 kHz): 100 mm.

D41G-A2

Admissible mounting set-up

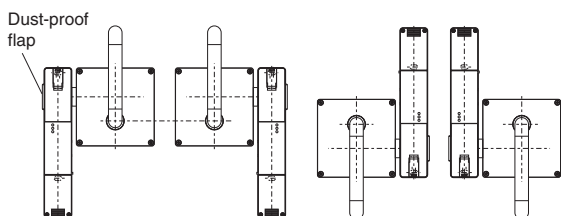

Inadmissible mounting set-up

Do not mount the switch upside down.

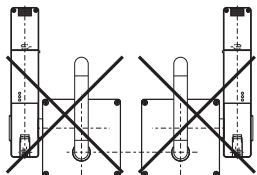

Mounting play between safety door switch and actuator

Actuator unit play

X = ± 1.5 mm
Y = ± 5.0 mm
Z = ± 1.0 mm

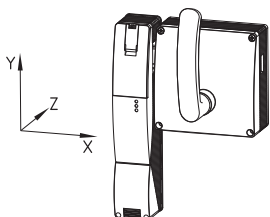

Representation of installation options

Actuators D41G-A2 is available for exterior installation.

The safety door switch D41G is placed outside the hazardous area.

| | | |
|------------------------|------------|--|
| With emergency exit | Right door | |
| | Left door | |
| Without emergency exit | Right door | |
| | Left door | |

The minimum radius of the door is 400 mm.

Assumptions:

40 mm profile

- Distance between safety door switch and actuator unit: 7.5 mm.
- Use standard hinge for 40 mm profile.

D41G-A1□(-E0)

Mounting play between safety door switch and actuator

X = ± 1.5 mm
Y = ± 5.0 mm
Z = ± 1.0 mm

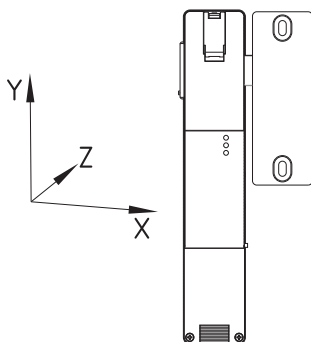

D41G

Mounting method

D41G-A2

1. To free mounting holes, unscrew the cover C for the wiring compartment and open flap A for the manual release.

To be observed:

- For exterior installation: Actuation of manual release (beneath flap A) with triangular key (included in delivery with safety door switch D41G)

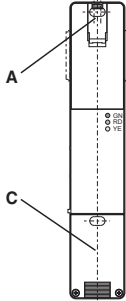

2. Mount enclosure of safety door switch D41G flush with doorpost.

To be observed:

- Screws M6 (not included in delivery with safety door switch D41G)
- Tightening torque for safety door switch (A): 8 N·m
- Tightening torque for cover screw (B): 0.7 to 1 N·m (Torx T10)
- Wall thickness of the device: 19 mm
- Washers 6.4-dia (included in delivery with safety door switch D41G)
- For applications with strong vibrations, please observe a proper securing of the screws.

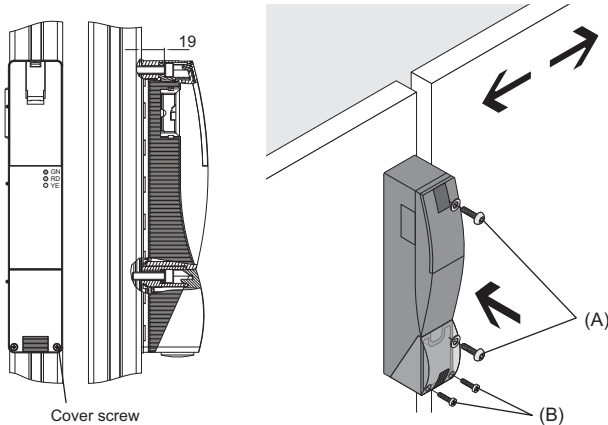

3. Insert sliding blocks (included in delivery with actuator unit D41G-A2) as shown.

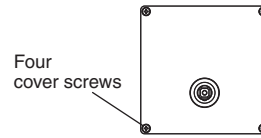

4. Insert sliding blocks (included in delivery with actuator unit D41G-A2) as shown.

Observe the alignment (notch) of the sliding blocks.

- D: for left (D41G-A2L)
- E: for right (D41G-A2R)

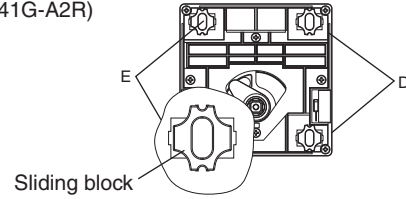

5. Fit the actuator unit to the doorpost by means of the spacer F (7.5 mm)

To be observed:

- Actuator unit completely retracted
- Distance between safety door switch and actuator unit or emergency exit: 7.5 +0.5/-2.5 mm
- Screws M6 (not included in delivery with safety door switch D41G)
- Torque: 8 N·m
- Wall thickness of actuator: 8 mm (see step 11)
- Washers 6.4-dia (included in delivery with D41G-A2)
- For applications with strong vibrations, please observe a proper securing of the screws.

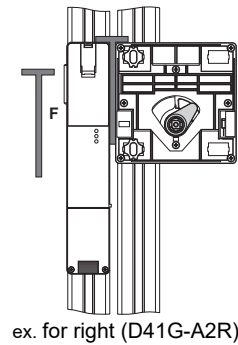

6. Mount the cover on the actuator unit

To be observed:

- Actuator unit completely retracted

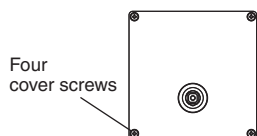

7. Fit the door-handle

- Mount the door handle or emergency exit unit (D41G-A2□-E1) horizontally
 - D: for left (D41G-A2L)
 - E: for right (D41G-A2R)
 - G: Hexagonal screw A/F 3 with screw-lock (included in delivery with D41G-A2)
- For the model with emergency exit unit (D41G-A2□-E1T), attach the included lockout tag (SZ) at the same position as shown in the figure below, and then attach the resin ring and handle.
- For outdoor installation without emergency exit continue to step 14

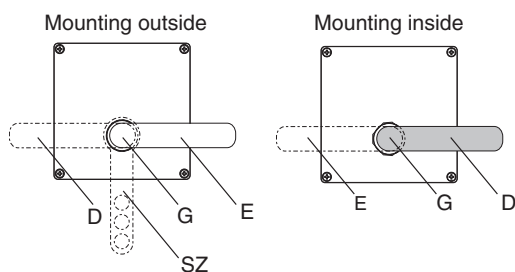

- 8. If an emergency exit unit (D41G-A2□-E1) is available, cut square tube H at length. De-burr the cut sides.

To be observed:

- Maximum door leaf thickness: 170 mm

Mounting outside

Length of square rod H (mm) = door leaf thickness + 22-2 mm

- Through-hole for square tube H: 16 mm dia.

Mounting outside

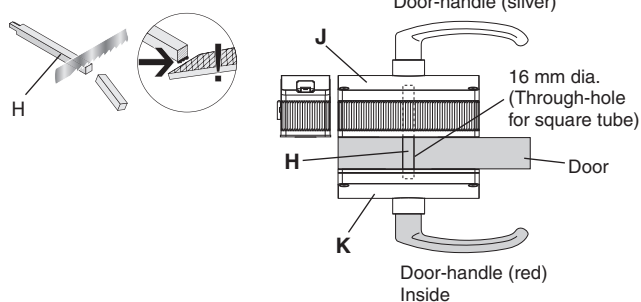

9. Unscrew the cover of the emergency exit unit (D41G-A2□-E1)

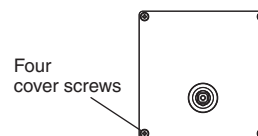

10. Insert sliding blocks as shown (included in delivery with D41G-A2□-E1)

To be observed:

Observe the alignment (notch) of the sliding blocks

- D: for left (D41G-A2L-E1)
- E: for right (D41G-A2R-E1)

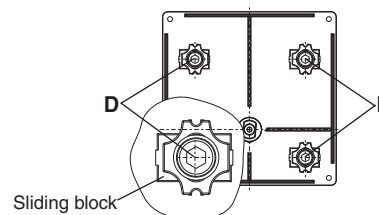

11. Fit the bottom plate of the emergency exit unit to the door

To be observed:

- Actuator completely in J (actuator unit or emergency exit unit) retracted
- Arrange both the emergency exit unit (K) and the actuator unit (J) parallel
- Screws M6
- Tightening torque: 8 N·m
- Wall thickness of the device: 8 mm
- Washers 6.4-dia (included in delivery with D41G-A2□-E1)
- For applications with strong vibrations, please ensure the screws are correctly secured.

Mounting outside

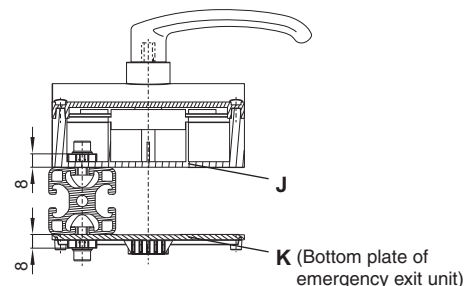

12. Insert square rod H in the backside of the actuator

To be observed:

For mounting outside: Insert chamfer of square into emergency exit or insert cut side of square into actuator unit. Position of the chamfer as shown, when actuator unit is actuated.

Mounting outside

Locked state
(handle up)

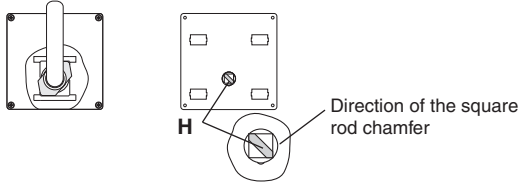

15. After being set up, secure the cover A of the manual release with the seal, which is included in delivery with safety door switch D41G.

Seal the cover of the manual release A

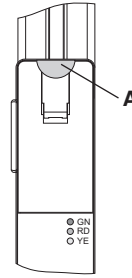

13. Fit the cover and the handle onto the emergency exit

To be observed:

- Position of the driving shaft I as shown, when actuator unit is actuated.
- Functional test of the emergency exit handle:
 - It should be possible to open the guard door inside the hazardous area.
 - It should not be possible to lock the guard door from inside.
 - The emergency exit handle must be in upright position when closed.

Mounting inside

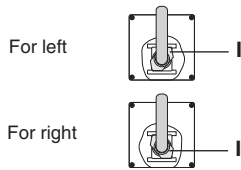

14. Clip the dust-proof flap in the unused side.

To be observed:

Clip at the locations as shown in the figure below.

- M: for left (D41G-A2L)
- N: for right (D41G-A2R)

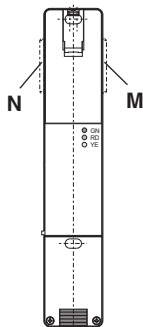

D41G-A1

1. Unscrew cover C for the wiring compartment and open the manual release flap A.

To be observed

Actuation of manual release with triangular key
(included in delivery with safety door switch D41G)

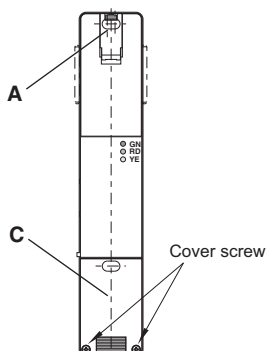

2. Mount enclosure of safety door switch D41G flush with doorpost.

To be observed

- Screws M6 (not included in delivery with safety door switch D41G)
- Washers 6.4-dia (included in delivery with safety door switch D41G)
- Tightening torque for safety door switch: 8 N·m (A)
- Tightening torque for cover screw: 0.7 to 1 N·m (Torx T10) (B)
- Wall thickness of safety door switch: 19 mm
- For applications with strong vibrations, please observe a proper securing of the screws

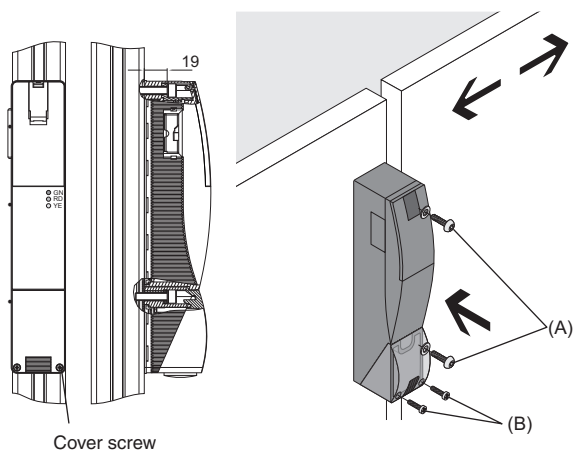

3. Fit the actuator to the doorpost.

To be observed

- Actuator with emergency exit (emergency release tab) D41G-A1-E0 may only be installed concealed.
- Top side of the safety door switch D41G flush with actuator top side
- Distance between safety door switch D41G and actuator: 5 ± 1.5 mm
- Screws M6 (not included in delivery with safety door switch D41G)
- Washers 6.4-dia (included in delivery with actuator D41G-A1)
- Wall thickness of actuator: 8 mm
- Tightening torque 8 N·m (C)
- For applications with strong vibrations, please observe a proper securing of the screws

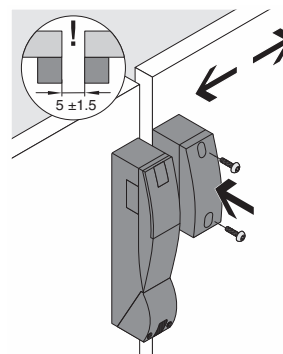

4. Clip the dust-proof cover in the unused side.
(included in delivery with safety door switch D41)

To be observed

M: for left
N: for right

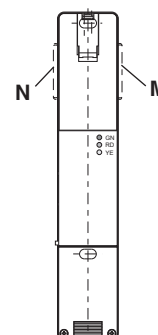

5. After being set up, secure the cover A of the manual release with the seal, which is included in delivery with safety door switch D41G.

Seal the cover of the manual release A

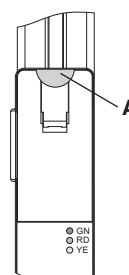

Troubleshooting

Operation in case of errors

Errors that no longer guarantee the function of the safety door switch (internal errors) are visualized by the red LED on the switch and cause the auxiliary output to be disabled. The safety outputs (OSSD) are disabled immediately (within the risk time).

Any error that does not immediately affect the safety functionality of the safety door switch (e.g., too high ambient temperature, interference potential at the safety outputs, cross-wire short at the safety outputs) will lead to a warning message signaled by the flashing of the red LED on the switch and disabling of the auxiliary output. The safety outputs (OSSD) initially remain enabled but will be disabled after 30 minutes if the fault is not rectified.

In either case, the error warning is reset by opening and re-closing the relevant guard door after error rectification, and the safety outputs (OSSD) are enabled.

After the error cause is removed, the warning indication (e.g., LED flashes) is reset.

Diagnostic information for switch and error message

The switch indicates the operating condition and faults with its three-color LED and the errors with its red LED. Refer to Tables 1 and 2 on page 16 for details.

Set-up and Maintenance/Disassembly and Disposal

Set-up and Maintenance

Functional testing

The safety function of the safety components must be tested. The following conditions must be previously checked and met:

1. Fitting of the Switch and the actuator
2. Check the integrity of the cable entry and connections
3. Check the switch enclosure for damage

Maintenance

Maintenance frequency

SIL3 / PLe at least once a month

SIL2 / PLd at least once a year

The following inspections must be carried out:

(Daily inspection)

- For each guard door, check that the machine stops when the guard door opens.

(Inspection every 6 months)

Regularly conduct visual and functional inspections including:

1. Check for tight installation of the safety door switch and the actuator.
2. Check maximum axial offset of the safety door switch and the actuator.
3. Remove particles of dust and soiling
4. Check cable entry and connections

Disassembly and Disposal

Disassembly

The product must be disassembled in a de-energized condition only.

Disposal

The product must be disposed of in an appropriate manner in accordance with the national prescriptions and legislations.

Safety Precautions



Be sure to read the precautions for all models in the website at: <http://www.ia.omron.com/>.

Indication and Meaning for Safe Use

Warning Indications

| | |
|--|--|
|  WARNING | Indicates a potentially hazardous situation which, if not avoided, will result in minor or moderate injury, or may result in serious injury or death. Additionally there may be significant property damage. |
| Precautions for Safe Use | Supplementary comments on what to do or avoid doing, to use the product safely. |
| Precautions for Correct Use | Supplementary comments on what to do or avoid doing, to prevent failure to operate, or undesirable effect on product performance. |

Meaning of Product Safety Symbols

| | |
|---|--|
|  | General prohibition Instructions on unspecified prohibited action. |
|  | General instructions Instructions on unspecified general action. |

 **WARNING**

Use only appropriate components or devices complying with relevant safety standards corresponding to the required performance level and safety category. Failure to do so may result in serious injury or death. Conformity to requirements of the performance level and safety category must be determined as an entire system. It is recommended to consult a certification body regarding assessment of conformity to the required safety level.



Do not apply DC voltages exceeding the rated voltages, nor any AC voltages to the product. Failure to do so may result in serious injury or death.



Install the switch and actuator in a position where the opening of the guard door can be detected within a safe distance. Failure to do so may result in serious injury or death.



Do not apply force exceeding the specified holding force (Fzh). Either install another locking component (e.g., a hook) in addition to the product, or use a warning measures or an indicator showing the controlled system is locked to avoid overloading the holding force in lock mode. Failure to do so may result in serious injury or death.



When complying with safety standards, install the product in an appropriate manner in accordance with ISO 14119, with due consideration of the risk of defeat by the operator. Failure to do so may result in serious injury or death.



Make sure that the DC power supply meets the following items. Failure to do so may result in serious injury or death.

- Satisfies the requirements of PELV power supply defined in IEC 60204-1.
- Satisfies the requirements of class 2 circuits defined in UL508.



Precautions for Safe Use

1. Disconnect the product from power supply when wiring the product. Failure to do so may cause unexpected operation of devices connected to the product.
2. Wire the input and output terminals correctly and verify the correct operation of the product before using the system in which the product is incorporated. Incorrect wiring may lead to loss of the safety function.
3. Install the actuator in a place where it will not come in contact with your body when opening or closing the guard door. Failure to do so may result in injury.
4. Do not use the product in any direction other than the specified mounting orientations of the main body and actuator.
5. Dispose of the product in accordance with the laws set by each country.
6. When the door is closed (with the actuator inserted), the actuator may be pushed back beyond the mounting play due to the weight of the door or the cushioning rubber of the door. Secure the door with a hook or by similar means so that it stays within the mounting play. (Refer to the D41G actuator's Quick Installation Manual.)

Precautions for Correct Use

1. Do not drop the product to the ground or expose to excessive vibration or mechanical shocks. Doing so may damage the product and cause failure.
2. Do not store or use the product under the following conditions. Doing so may damage the product and cause failure.
 - 1) At ambient operating temperatures out of the range of -10 to 55°C
 - 2) At ambient storage temperatures out of the range of -10 to 55°C
 - 3) At relative humidity of 93% or more
 - 4) In direct sunlight
 - 5) Under drastic temperature changes
 - 6) In high humidity that causes condensation
3. Keep the product away from oil or solvent. Oil or solvent make the marking on the product illegible and cause deterioration of some parts.
4. Do not use in an environment with corrosive gas.
5. The product may not operate normally in the vicinity of devices that generate strong radio waves or magnetic fields, such as RFID systems, proximity sensors, motors, inverters, and switch-mode power supplies. If the device is used in the vicinity of such devices, check the effect before use.
6. Installing the switch and the actuator on a metallic material may affect the operating distance. If installation on a metallic material is necessary, be sure to check the effect on the operating distance before use.
7. Tighten the screws with a specified torque.
8. Use the wires specified by OMRON to wire the product. (Refer to *Connection* on page 10.)
9. Do not extend the cables in excess of the specification of this product. Carry out electrical connection according to the wiring examples shown in this document and verify the correct operation of the product.
10. Do not pull or bend the cable excessively. A disconnection may cause a malfunction.
11. Risk time remains unchanged by series connection. However, carry out electrical connection according to the wiring examples shown in this document.
12. Be sure to inspect the product daily and every 6 months. Failure to do so may cause a system failure and serious injury.
13. When determining the safety distance, take into account the delay of the output of the product caused by the response time. Failure to do so may cause the operator to reach the hazardous source before the machine is stopped, resulting in serious injury.
14. During installation, make sure that the safety door switch does not come in contact with the actuator due to rattling of the guard door. (The performance of the product may be degraded by a collision caused by opening or closing the guard door.)
15. Install the product so that the LED indicators of the safety door switch are as visible as possible. Misinterpreting the status of the safety door switch may result in danger.

16. Do not use the product at an altitude of 2,000 m or higher.
17. Do not connect a product different from this product in series with this product. Doing so may disturb waveforms of the input and output signals, leading to loss of the safety function.
18. Do not use the product in the water or continuous water exposure environment. Doing so may cause water to leak into the product. (The degree of protection does not guarantee the protection under continuous water exposure environment.)
19. Do not tamper the product with a replacement actuator. Store replacement actuators in a safe place where they cannot be easily reached.
20. Build a safety system using the outputs of both Safety Outputs 1 and 2. Wiring with only one safety output may lead to loss of the safety function due to a single failure.
21. Wiring should meet the requirements specified in Section 9.4.3 of IEC 60204-1 to prevent malfunction due to ground faults in the safety output lines.
22. In the power-to-lock type, close the door before energizing the safety door switch.
23. In the power-to-lock type, the safety door switch is locked only when the solenoid is energized. If the solenoid is de-energized due to a sudden power failure, the operator may be exposed to a hazardous source. Use the power-to-lock type only for process protection.
24. Do not use the emergency-exit type for switching the machine on and off. Doing so may place operators at risk due to being trapped inside or unexpected operation of the machine.
25. Install the emergency-exit type so that it cannot be operated from outside a safety zone.
26. Do not apply excessive force on the actuator while the actuator is inserted into the switch body or do not drop the product. Doing so may deform the actuator or damage the switch body.
27. Insert the actuator with a tolerance of $\pm 1.5\text{mm}$ for X, $\pm 5.0\text{mm}$ for Y and $\pm 1.0\text{mm}$ for Z to the center of the key hole. Misalignment or tilting may cause premature wear or damage. (Refer to the D41G actuator's Quick Installation Manual for the corresponding actuator.)
28. The safety function may not operate normally due to a malfunction of the wiring, setting, or switch, and the machine may continue to operate, which may result in personal injury. Make sure that the safety function works before starting operation.
29. Do not pull on lead wires with excessive force. Doing so may cause loose connection.
30. The current consumption of the safety door switch is different between when it is turned on and when it is in a normal operation. Apply the supply voltage to the safety door switch in consideration of the voltage drop in the wiring.
31. Do not turn beyond the latching point. After being put into operation, the manual release must be secured by closing the cover with the seal, which is included in delivery.
32. After installation of the product, qualified personnel should verify to see that the installation, inspection, and maintenance are properly performed. The qualified personnel should be qualified and authorized to secure the safety on each phase of design, installation, running, maintenance and disposal of system.
33. Do not wire the product to an input of a safety controller in parallel.
34. Disconnect the product and the controller connected to the product from power supply when replacing the product. Failure to do so may cause unexpected operation of devices connected to the product.
35. Install the product to a position near a handle of the guard door. Installing it near a hinge may cause the locking part of the product to receive larger load than the operating force, leading to damage to the locking mechanism.
36. Do not use the product as a door stopper. (The performance of the product may be degraded due to a collision caused by opening and closing the guard door.)
37. Do not try to disassemble, repair, or modify the product. Doing so may cause loss of the safety function.
38. Be sure to attach the cover after wiring work. Also, do not energize with the cover open. There is a risk of electric shock.
39. Do not operate the product in an environment with flammable or explosive gas.
40. Auxiliary output is NOT a safety output. Do not use the Auxiliary output individually for any safety function. Such incorrect use causes loss of the safety function of the product and its relevant systems.

Terms and Conditions Agreement

Read and understand this catalog.

Please read and understand this catalog before purchasing the products. Please consult your OMRON representative if you have any questions or comments.

Warranties.

(a) Exclusive Warranty. Omron's exclusive warranty is that the Products will be free from defects in materials and workmanship for a period of twelve months from the date of sale by Omron (or such other period expressed in writing by Omron). Omron disclaims all other warranties, express or implied.

(b) Limitations. OMRON MAKES NO WARRANTY OR REPRESENTATION, EXPRESS OR IMPLIED, ABOUT NON-INFRINGEMENT, MERCHANTABILITY OR FITNESS FOR A PARTICULAR PURPOSE OF THE PRODUCTS. BUYER ACKNOWLEDGES THAT IT ALONE HAS DETERMINED THAT THE PRODUCTS WILL SUITABLY MEET THE REQUIREMENTS OF THEIR INTENDED USE.

Omron further disclaims all warranties and responsibility of any type for claims or expenses based on infringement by the Products or otherwise of any intellectual property right. (c) Buyer Remedy. Omron's sole obligation hereunder shall be, at Omron's election, to (i) replace (in the form originally shipped with Buyer responsible for labor charges for removal or replacement thereof) the non-complying Product, (ii) repair the non-complying Product, or (iii) repay or credit Buyer an amount equal to the purchase price of the non-complying Product; provided that in no event shall Omron be responsible for warranty, repair, indemnity or any other claims or expenses regarding the Products unless Omron's analysis confirms that the Products were properly handled, stored, installed and maintained and not subject to contamination, abuse, misuse or inappropriate modification. Return of any Products by Buyer must be approved in writing by Omron before shipment. Omron Companies shall not be liable for the suitability or unsuitability or the results from the use of Products in combination with any electrical or electronic components, circuits, system assemblies or any other materials or substances or environments. Any advice, recommendations or information given orally or in writing, are not to be construed as an amendment or addition to the above warranty.

See <http://www.omron.com/global/> or contact your Omron representative for published information.

Limitation on Liability; Etc.

OMRON COMPANIES SHALL NOT BE LIABLE FOR SPECIAL, INDIRECT, INCIDENTAL, OR CONSEQUENTIAL DAMAGES, LOSS OF PROFITS OR PRODUCTION OR COMMERCIAL LOSS IN ANY WAY CONNECTED WITH THE PRODUCTS, WHETHER SUCH CLAIM IS BASED IN CONTRACT, WARRANTY, NEGLIGENCE OR STRICT LIABILITY.

Further, in no event shall liability of Omron Companies exceed the individual price of the Product on which liability is asserted.

Suitability of Use.

Omron Companies shall not be responsible for conformity with any standards, codes or regulations which apply to the combination of the Product in the Buyer's application or use of the Product. At Buyer's request, Omron will provide applicable third party certification documents identifying ratings and limitations of use which apply to the Product. This information by itself is not sufficient for a complete determination of the suitability of the Product in combination with the end product, machine, system, or other application or use. Buyer shall be solely responsible for determining appropriateness of the particular Product with respect to Buyer's application, product or system. Buyer shall take application responsibility in all cases.

NEVER USE THE PRODUCT FOR AN APPLICATION INVOLVING SERIOUS RISK TO LIFE OR PROPERTY OR IN LARGE QUANTITIES WITHOUT ENSURING THAT THE SYSTEM AS A WHOLE HAS BEEN DESIGNED TO ADDRESS THE RISKS, AND THAT THE OMRON PRODUCT(S) IS PROPERLY RATED AND INSTALLED FOR THE INTENDED USE WITHIN THE OVERALL EQUIPMENT OR SYSTEM.

Programmable Products.

Omron Companies shall not be responsible for the user's programming of a programmable Product, or any consequence thereof.

Performance Data.

Data presented in Omron Company websites, catalogs and other materials is provided as a guide for the user in determining suitability and does not constitute a warranty. It may represent the result of Omron's test conditions, and the user must correlate it to actual application requirements. Actual performance is subject to the Omron's Warranty and Limitations of Liability.

Change in Specifications.

Product specifications and accessories may be changed at any time based on improvements and other reasons. It is our practice to change part numbers when published ratings or features are changed, or when significant construction changes are made. However, some specifications of the Product may be changed without any notice. When in doubt, special part numbers may be assigned to fix or establish key specifications for your application. Please consult with your Omron's representative at any time to confirm actual specifications of purchased Product.

Errors and Omissions.

Information presented by Omron Companies has been checked and is believed to be accurate; however, no responsibility is assumed for clerical, typographical or proofreading errors or omissions.

High-Coded Safety Door Switch

OMRON

**High-Coded Non-Contact Safety Door Switch
D41D**

Matches with machine design. Initial setup by touch teaching is quick and easy.

- High-coded safety door switch effective in tamper protection
- Easy automatic teaching
- Fits in narrow spaces and corners inside machines
- Three types of actuators
- Complies with EN ISO 14119 (Type A) High-Coded), EN ISO 13849-1 (PLd)

Three types of actuators fit in narrow spaces and corners inside machinery

Easy teaching reduces commissioning time

Space saving installation

High tolerance to door misalignment

Easy teaching force adjustment

LED display

OMRON 1

High-Coded Non-Contact Safety Door Switch D41D (No.F112)

OMRON

**High-Coded Guard Lock Safety Door Switch
D41L**

Designed for hygiene-sensitive machines

- High-coded safety door switch effective in tamper protection
- High-gloss design with smooth surface that leaves no visible fingerprints and prevents water or dust contamination
- Smooth surface leaves no wiping requirements
- Complies with EN ISO 14119 (Type A) High-Coded), EN ISO 13849-1 (PLd), IEC/EN 61508 certified

Features

Identical mounting for left and right hinged doors

High tolerance to door misalignment

Easy teaching force adjustment

LED display

OMRON 1

High-Coded Guard Lock Safety Door Switch D41L (No.F113)

OMRON

**High-Coded Guard Lock Safety Door Switch (For Gate)
D41G**

Prevent people from being trapped inside hazardous areas

- High-coded safety door switch effective in tamper protection
- Integrated door handle structure reduces guarding design time
- Integrated handle's smooth operation enables quick emergency exit
- Switch can be released to avoid being trapped inside when power supply is unavailable
- Complies with EN ISO 14119 (Type A) High-Coded), EN ISO 13849-1 (PLd)

Features

Reduce maintenance effort

Easy teaching force adjustment

LED display

OMRON 1

High-Coded Guard Lock (For Gate) Safety Door Switch D41G (No.F114)

Note: Do not use this document to operate the Unit.

OMRON Corporation Industrial Automation Company

Kyoto, JAPAN

Contact : www.ia.omron.com

Regional Headquarters

OMRON EUROPE B.V.
Wegalaan 67-69, 2132 JD Hoofddorp
The Netherlands
Tel: (31) 2356-81-300 Fax: (31) 2356-81-388

OMRON ELECTRONICS LLC
2895 Greenspoint Parkway, Suite 200
Hoffman Estates, IL 60169 U.S.A.
Tel: (1) 847-843-7900 Fax: (1) 847-843-7787

OMRON ASIA PACIFIC PTE. LTD.
438B Alexandra Road, #08-01/02 Alexandra
Technopark, Singapore 119968
Tel: (65) 6835-3011 Fax: (65) 6835-3011

OMRON (CHINA) CO., LTD.
Room 2211, Bank of China Tower,
200 Yin Cheng Zhong Road,
PuDong New Area, Shanghai, 200120, China
Tel: (86) 21-6023-0333 Fax: (86) 21-5037-2388

Authorized Distributor:

©OMRON Corporation 2021-2023 All Rights Reserved.
In the interest of product improvement,
specifications are subject to change without notice.

CSM_3_1
Cat. No. F114-E1-04 0823 (0321)