

Safety CPU Unit

NX-SL3□□□

The simplest way to integrate safety into ultra-high-speed machine automation - Bring safety to your production site

- Automatic generation, from safety programs through to safety functional test reports
- Integrated safety over EtherCAT® for high-speed, high-precision fieldbus communication in a machine
- Easy to set up safety functions for motion devices that are the key to quality and productivity enhancement



For the most recent information on models that have been certified for safety standards, refer to your OMRON website.

Features



- Meets EN ISO 13849-1 (PLe/Category 4) and IEC 61508 (SIL3)
 - Safety over EtherCAT (FSoE) * allows standard devices and safety devices to be mixed on the same EtherCAT® network
 - A stand-alone system can be built by combining the NX-SL3300 Safety CPU Unit with the NX-EIC202 EtherNet/IP Coupler Unit
 - Safety program POU's in IEC 61131-3 compliant Automation Software Sysmac Studio make programming more efficient and design assets reusable
 - PLCopen® Function Blocks for Safety reduce time and cost to learn safety design
 - Design functions minimize safety design errors: visual setting of I/O, automatic generating wiring diagram, safety programming, and automatic conversion of programs into user-defined Function Blocks
 - Verification functions ensure and maintain safety during machine commissioning and operation: Simple Automatic Test using Offline Simulation, Safety Validation when safety application data is saved in memory, and Online Functional Test
- * Safety over EtherCAT (FSoE): The open protocol Safety over EtherCAT (abbreviated with FSoE "FailSafe over EtherCAT") defines a safety related communication layer for EtherCAT®. Safety over EtherCAT meets the requirements of IEC 61508 SIL 3 and enables the transfer of safe and standard information on the same communication system without limitations with regard to transfer speed and cycle time.

- Sysmac is a trademark or registered trademark of OMRON Corporation in Japan and other countries for OMRON factory automation products.
- EtherCAT® is registered trademark and patented technology, licensed by Beckhoff Automation GmbH, Germany.
- Safety over EtherCAT® is registered trademark and patented technology, licensed by Beckhoff Automation GmbH, Germany.
- ODVA, CIP™, CompoNet™, DeviceNet™, EtherNet/IP™, and CIP Safety™ are trademarks of ODVA.
- PLCopen® and related logo are registered trademarks of PLCopen®.

Other company names and product names in this document are the trademarks or registered trademarks of their respective companies.

Ordering Information

Safety CPU Unit NX-SL3□□□

Unit type	Appearance	Specifications				Unit version	Model
		Maximum number of safety I/O points	Program capacity	Number of safety I/O connections	I/O refreshing method		
Safety CPU Unit (NX-SL3□□□)		256 points	512KB	32	Free-Run refreshing	Ver. 1.1	NX-SL3300
		1024 points	2048KB	128	Free-Run refreshing	Ver. 1.1	NX-SL3500

Accessories

Not included.

Automation Software Sysmac Studio

Please purchase a DVD and required number of licenses the first time you purchase the Sysmac Studio. DVDs and licenses are available individually. Each model of licenses does not include any DVD.

Product name	Specifications	Number of licenses	Media	Model
Sysmac Studio Standard Edition Ver.1.□□ *1	The Sysmac Studio is the software that provides an integrated environment for setting, programming, debugging and maintenance of machine automation controllers including the NJ/NX-series CPU Units, NY-series Industrial PC, EtherCAT Slave, and the HMI.	--- (Media only)	Sysmac Studio 32-bit edition DVD	SYSMAC-SE200D
	Sysmac Studio runs on the following OS. *2 Windows 7(32-bit/64-bit version)/8(32-bit/64-bit version)/8.1(32-bit/64-bit version)/10(32-bit/64-bit version)/11(64-bit version)	--- (Media only)	Sysmac Studio 64-bit edition DVD	SYSMAC-SE200D-64
	The Sysmac Studio Standard Edition DVD includes Support Software to set up EtherNet/IP Units, DeviceNet slaves, Serial Communications Units, and Support Software for creating screens on HMIs (CX-Designer). * Refer to your OMRON website for details such as supported models and functions.	1 license *3	---	SYSMAC-SE201L
Sysmac Studio Safety Edition Ver.1.□□ *4	Sysmac Studio Safety Edition is a license including necessary setting functions for the safety control system. * This product is a license only. You need the Sysmac Studio Standard Edition DVD media to install it.	1 license	---	SYSMAC-FE001L

Note: For details of the automation software Sysmac Studio, refer to your local OMRON website.

- *1 The SYSMAC-SE□□□□L Sysmac Studio Standard Edition with license(s) provides functions that the SYSMAC-FE001L Safety Edition provides. With the version 1.10 or higher, you can use the setup functions for the EtherNet/IP Coupler Unit.
- *2 SYSMAC-SE200D-64 runs on Windows 10 (64-bit edition) or higher.
- *3 Multi licenses are available for the Standard Edition (3, 10, 30, or 50 licenses).
- *4 Safety Edition can be used with Communication Control Unit and EtherNet/IP Coupler Unit. The SYSMAC-NE001L NX-I/O Edition can be used for configuration of a stand-alone safety control system using the EtherNet/IP Coupler Unit and NX-SL3300 Safety CPU Unit.

Regulations and Standards

Safety CPU Units NX-SL3□□□

Certification body	Standards
TÜV Rheinland	<ul style="list-style-type: none"> • EN ISO 13849-1 • EN ISO 13849-2 • IEC 61508 parts 1-7 • IEC/EN 61131-2 • IEC 61326-3-1
UL	<ul style="list-style-type: none"> • NRAG (UL 508 and ANSI/ISA 12.12.01) • NRAG7 (CSA C22.2 No. 142 and CSA C22.2 No. 213)
Shipbuilding Standards	NK, LK

The NX-series Safety CPU Units allow you to build a safety control system that meets the following standards:



- Requirements for SIL 3 (Safety Integrity Level 3) in IEC 61508
- Requirements for PL_e (Performance Level e) and category 4 in EN ISO13849-1

The NX-series Safety CPU Units are also registered for RCM, EAC, and KC compliance.

General Specifications

Item	Specification	
Enclosure	Mounted in a panel (open)	
Grounding method	Ground to 100 Ω or less.	
Operating environment	Ambient operating temperature	0 to 55°C (The upper limit of the ambient operating temperature is restricted by the installation orientation.)
	Ambient operating humidity	10% to 95% (with no condensation or icing)
	Atmosphere	Must be free from corrosive gases.
	Ambient storage temperature	-25 to 70°C (with no condensation or icing)
	Altitude	2,000 m max.
	Pollution degree	2 or less.
	Noise immunity	Conforms to IEC 61131-2. 2 kV on power supply line (Conforms to IEC 61000-4-4.)
	Insulation class	Class III (SELV)
	Overvoltage category	II
	EMC immunity level	Zone B
Vibration resistance	Conforms to IEC 60068-2-6.	
	5 to 8.4 Hz with 3.5-mm amplitude, 8.4 to 150 Hz, acceleration of 9.8 m/s ² , 100 minutes each in X, Y, and Z directions (10 sweeps of 10 min each = 100 min total)	
Shock resistance	Conforms to IEC 60068-2-27.	
	147 m/s ² , 3 times each in X, Y, and Z directions	
Installation method	DIN Track (IEC 60715 TH35-7.5/TH35-15)	

Unit Specifications

Unit name		Safety CPU Unit	
Model	NX-SL3300	NX-SL3500	
Maximum number of safety I/O points	256 points	1024 points	
Program capacity	512 KB	2048 KB	
Number of safety I/O connections	32	128	
Number of FSoE master connections	32	128	
I/O refreshing method	Free-Run refreshing		
External connection terminals	None		
Indicators			
Dimensions	30 × 100 × 71 mm (W × H × D)		
I/O power supply method	Not supplied.		
Current capacity of I/O power supply terminals	No I/O power supply terminals		
NX Unit power consumption *1	<ul style="list-style-type: none"> • Connected to a CPU Unit *2 1.25 W max. • Connected to a Communications Coupler Unit 0.90 W max. 		
Current consumption from I/O power supply	No consumption		
Weight	75 g max.		
Installation orientation and restrictions	Installation orientation: <ul style="list-style-type: none"> • Connected to a CPU Unit *2 Possible in the upright installation orientation. • Connected to a Communications Coupler Unit *3 Six possible orientations. Restriction: None		

*1 The cable length for the Units that supply power to the corresponding Unit must be up to 20 m.

*2 The NX102 CPU Unit and NX502 CPU Unit can be connected.

*3 The NX-SL3300 can be connected to the NX-ECC20□ EtherCAT Coupler Unit and NX-EIC202 EtherNet/IP Coupler Unit. The NX-SL3500 can be connected to the NX-ECC20□ EtherCAT Coupler Unit.

Combinations of CPU Unit, Communications Unit, and Software

The following table shows the NX-series CPU Unit, Communications Units, and Sysmac Studio editions that can be used with the NX-SL3□□□ Safety CPU Units.

CPU Unit and Communications Unit	NJ/NX Series CPU Unit *1	Communications Unit		
	NX102 CPU Unit NX502 CPU Unit	EtherCAT Coupler Unit NX-ECC20□	EtherNet/IP Coupler Unit NX-EIC202	Communication Control Unit NX-CSG320
Edition of Sysmac Studio *2	Standard Edition	Standard Edition	Standard Edition Sysmac Studio Safety Edition	Standard Edition Sysmac Studio Safety Edition
NX-SL3300	YES	YES	YES	No
NX-SL3500	YES	YES	No	No

*1 The NX-SL3□□□ Safety CPU Unit cannot be connected directly to the NJ/NX1P/NX7 CPU Unit. The NX-ECC20□ EtherCAT Coupler Unit is required to connect a system using these CPU Units.

*2 Refer to *Version Information* for the possible combinations of versions of Units and Sysmac Studio. The NX-I/O Edition can be used for configuration of a stand-alone safety control system using the EtherNet/IP Coupler Unit and NX-SL3300 Safety CPU Unit.

Version Information

The following table shows the possible combinations of versions of NX-series Safety Control Units, CPU Units, Communications Coupler Units, and Sysmac Studio. Available functions that are related to safety control vary depending on the versions of the units and Sysmac Studio. Refer to the *NX-series Safety Control Unit User's Manual* (Cat. No. Z930) for details.

NX-SL3□□□ version 1.1 can be connected to the following versions of the CPU Unit:

- NX102 CPU Unit version 1.30 or later and Sysmac Studio version 1.22 or higher
- NX502 CPU Unit version 1.60 or later and Sysmac Studio version 1.54 or higher

Combinations of versions

Safety Control Unit model and version		NX bus master: NX102 CPU Unit		NX bus master: NX502 CPU Unit		NX bus master: EtherCAT Coupler Unit			NX bus master: EtherNet/IP Coupler Unit	
Model	Unit version	NX102-□□□□	Sysmac Studio	NX502-□□□□	Sysmac Studio	Communications Coupler Unit NX-ECC20□	NJ/NX1P/NX7 CPU Unit *1	Sysmac Studio	Communications Coupler Unit NX-EIC202	Sysmac Studio
NX-SL3300	Ver.1.0	Ver.1.30 or later	Ver.1.22 or higher	Ver.1.60 or later	Ver.1.54 or higher	Ver.1.1 or later	Ver.1.06 or later	Ver.1.07 or higher	Ver.1.0 or later	Ver.1.10 or higher
	Ver.1.1							Ver.1.10 or higher		
NX-SL3500	Ver.1.0	Ver.1.30 or later	Ver.1.22 or higher	Ver.1.60 or later	Ver.1.54 or higher	Ver.1.2 or later	Ver.1.07 or later	Ver.1.08 or higher	---	---
	Ver.1.1							Ver.1.10 or higher		
NX-SIH400	Ver.1.0	Ver.1.30 or later	Ver.1.22 or higher	Ver.1.60 or later	Ver.1.54 or higher	Ver.1.2 or later	Ver.1.06 or later	Ver.1.07 or higher	---	---
	Ver.1.1							Ver.1.10 or higher		
NX-SID800	Ver.1.0	Ver.1.30 or later	Ver.1.22 or higher	Ver.1.60 or later	Ver.1.54 or higher	Ver.1.1 or later	Ver.1.06 or later	Ver.1.07 or higher	Ver.1.0 or later	Ver.1.10 or higher
NX-SOH200	Ver.1.0	Ver.1.30 or later	Ver.1.22 or higher	Ver.1.60 or later	Ver.1.54 or higher	Ver.1.1 or later	Ver.1.06 or later	Ver.1.07 or higher	Ver.1.0 or later	Ver.1.10 or higher
NX-SOD400	Ver.1.0	Ver.1.30 or later	Ver.1.22 or higher	Ver.1.60 or later	Ver.1.54 or higher	Ver.1.1 or later	Ver.1.06 or later	Ver.1.07 or higher	Ver.1.0 or later	Ver.1.10 or higher

*1 This is version information when the NJ/NX1P/NX7 CPU Unit is used as the EtherCAT master in the system. The Safety Control Unit cannot be connected directly to these CPU Units.

NX-SL3□□□

NX Unit Configuration

CPU Rack (Using NX102 CPU Unit)

The CPU Rack consists of an NX-series NX102 CPU Unit, NX Units, and an End Cover.
Up to 32 NX Units can be connected.

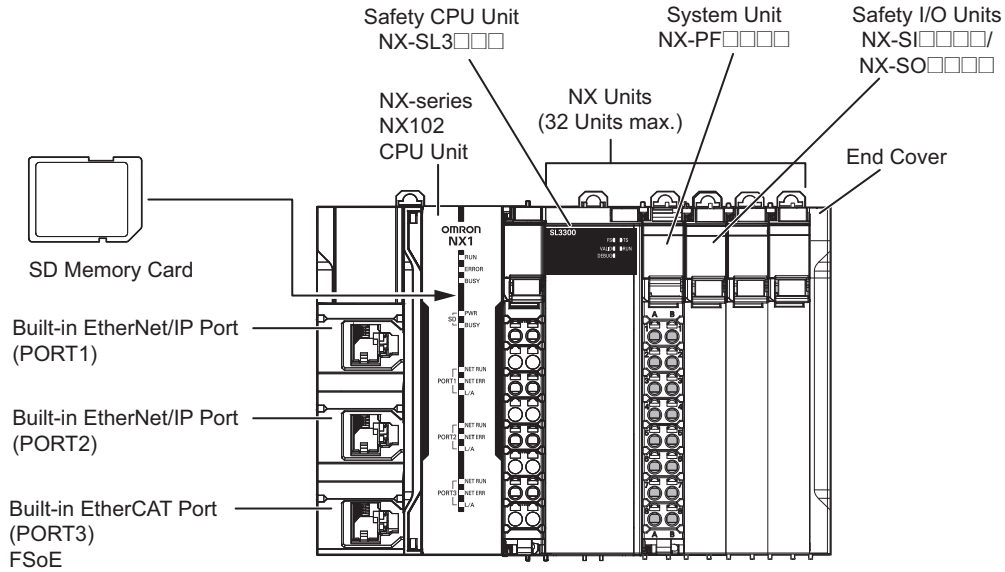

Up to 32 Units can be mounted to each CPU Rack.

For restrictions of the NX unit, refer to *NX-series NX102 CPU Unit Hardware User's Manual* (Cat. No. W593).

Series	Configuration	Remarks
NX-series	NX-series NX102 CPU Unit	One required for every CPU Rack. Up to 32 Units can be mounted to each CPU Rack. For restrictions of the NX unit, refer to <i>NX-series NX102 CPU Unit Hardware User's Manual</i> (Cat. No. W593).
	End Cover	Must be connected to the right end of the CPU Rack. One End Cover is provided with the CPU Unit.
	Safety Control Units	This is a programmable safety controller which supports IEC 61131-3 and PLCopen® TC5 Safety. This unit consists of safety CPU unit and safety I/O unit.
	Safety CPU Unit NX-SL3□□□	This Unit has safety control functions. It operates as an NX Unit. It also operates as an FSoE master.
	Safety I/O Units	These Units have safety input functions or safety output functions. They operate as NX Units. These Units operate as FSoE slaves.
	Safety Input Unit	These Units have safety input functions.
	Safety Output Unit	These Units have safety output functions.
	System Unit	When the I/O power supply for the NX Unit connected to the CPU Unit is supplied through the NX bus, the IO power supply unit (NX-PF) must be used as well.
	Other NX units	For the latest lineup of NX units, refer to our catalog and our website, or inquire of our local representative.
NJ/NX-series	SD Memory Card	Install as required.

CPU Rack (Using NX502 CPU Unit)

The CPU Rack consists of an NX-series NX502 CPU Unit, NX Units, and an End Cover.
Up to 63 NX Units can be connected.

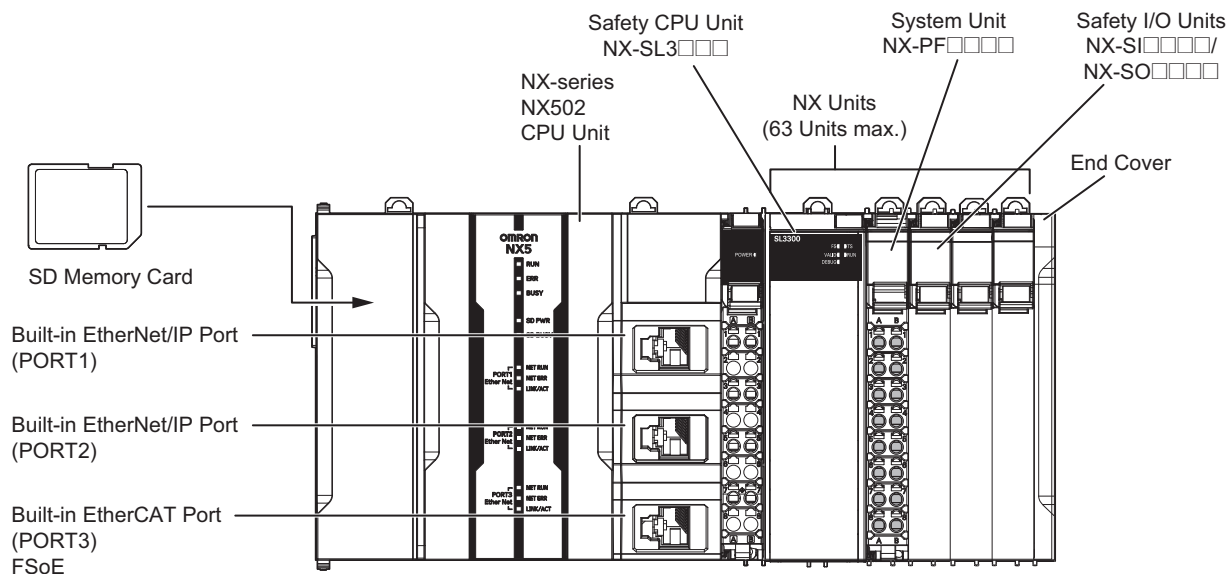

For restrictions of the NX unit, refer to *NX-series NX502 CPU Unit Hardware User's Manual* (Cat. No. W629).

Series	Configuration	Remarks
NX-series	NX-series NX502 CPU Unit	One required for every CPU Rack. Up to 63 Units can be mounted to each CPU Rack. For restrictions of the NX unit, refer to <i>NX-series NX502 CPU Unit Hardware User's Manual</i> (Cat. No. W629).
	End Cover	Must be connected to the right end of the CPU Rack. One End Cover is provided with the CPU Unit.
	Safety Control Units	This is a programmable safety controller which supports IEC 61131-3 and PLCopen® TC5 Safety. This unit consists of safety CPU unit and safety I/O unit.
	Safety CPU Unit NX-SL3□□□	This Unit has safety control functions. It operates as an NX Unit. It also operates as an FSoE master.
	Safety I/O Units	These Units have safety input functions or safety output functions. They operate as NX Units. These Units operate as FSoE slaves.
	Safety Input Unit	These Units have safety input functions.
	Safety Output Unit	These Units have safety output functions.
	System Unit	When the I/O power supply for the NX Unit connected to the CPU Unit is supplied through the NX bus, the IO power supply unit (NX-PF) must be used as well.
	Other NX units	For the latest lineup of NX units, refer to our catalog and our website, or inquire of our local representative.
NJ/NX-series	SD Memory Card	Install as required.

EtherCAT slave terminal

The EtherCAT slave terminal consists of NX-ECC EtherCAT coupler unit, component units of the NX unit, and end cover. Up to 63 NX Units can be connected.

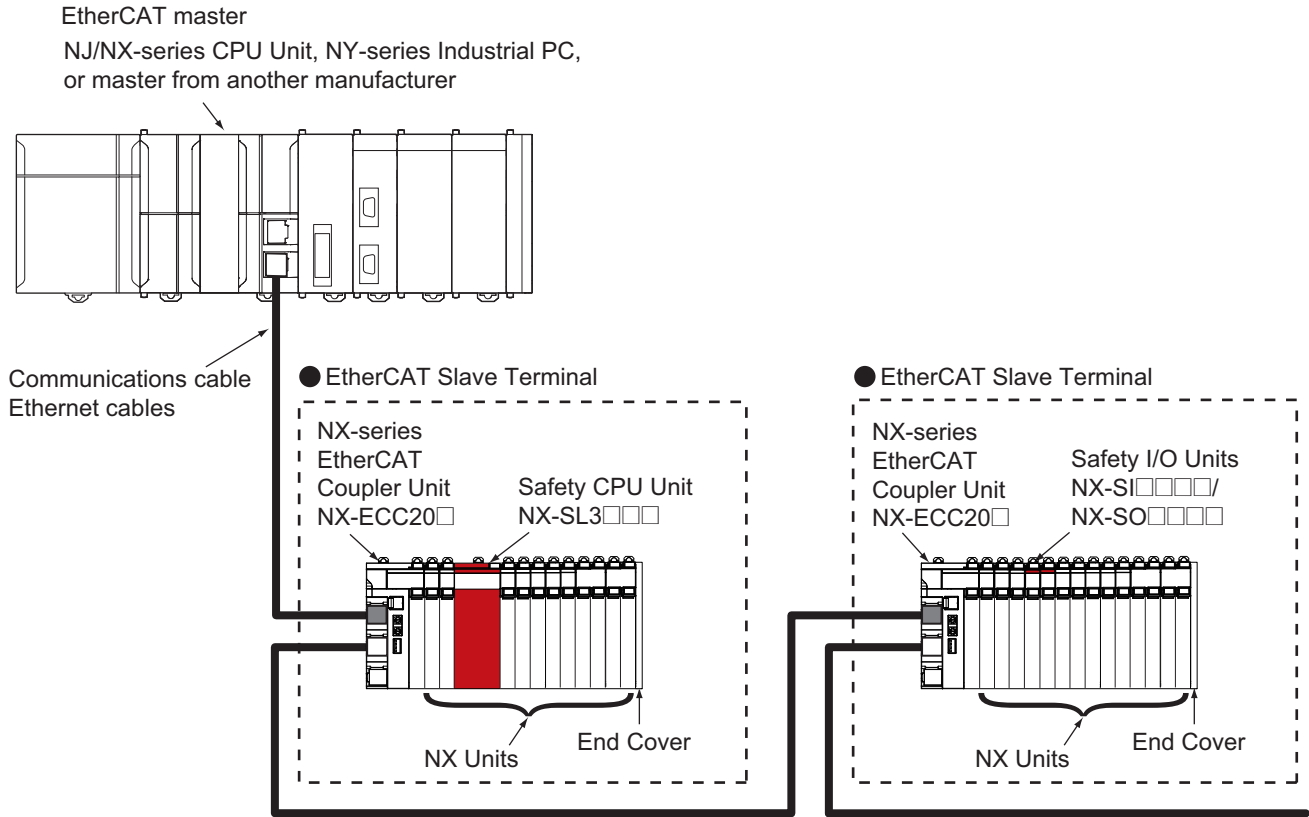

For restrictions of the NX unit, refer to *NX-series EtherCAT® Coupler Unit User's Manual* (Cat. No. W519).

Series	Configuration	Remarks			
NJ/NX-series	EtherCAT master	The EtherCAT master manages the EtherCAT network, monitors the status of the slaves, and exchanges I/O data with the slaves.			
NX-series	NX-series EtherCAT Coupler Unit NX-ECC□□□	The EtherCAT Coupler Unit is an interface that performs process data communications between a group of NX Units and the EtherCAT master over an EtherCAT network. The I/O data for the NX Units is first accumulated in the EtherCAT Coupler Unit and then all of the data is exchanged with the EtherCAT master at the same time. The EtherCAT Coupler Unit can also perform message communications (SDO communications) with the EtherCAT master. You can connect up to 63 NX Units.			
	End Cover	This is required on the right end of the EtherCAT slave terminal. One cover comes with each coupler unit by default.			
	NX Units	The NX Units perform I/O processing with connected external devices. The NX Units perform process data communications with the EtherCAT master through the EtherCAT Coupler Unit.			
	System Unit	System Units are used as required to build a Slave Terminal.			
	Safety Control Units	The Safety Control Units constitute a programmable safety controller that complies with IEC 61131-3 and PLCopen® TC5 Safety. They include Safety CPU Units and Safety I/O Units.			
	<table border="1" style="width: 100%;"> <tr> <td>Safety CPU Unit NX-SL3□□□</td> <td>This Unit controls the Safety I/O Units through the NX bus and EtherCAT.</td> </tr> <tr> <td>Safety I/O Units</td> <td>Safety CPU unit control this units through the NX bus and EtherCAT.</td> </tr> </table>	Safety CPU Unit NX-SL3□□□	This Unit controls the Safety I/O Units through the NX bus and EtherCAT.	Safety I/O Units	Safety CPU unit control this units through the NX bus and EtherCAT.
Safety CPU Unit NX-SL3□□□	This Unit controls the Safety I/O Units through the NX bus and EtherCAT.				
Safety I/O Units	Safety CPU unit control this units through the NX bus and EtherCAT.				
Other NX units	For types of NX units, refer to <i>NX-series EtherCAT® Coupler Unit User's Manual</i> (Cat. No. W519). For details of units, refer to the User's Manual of each unit. For the latest lineup of NX units, refer to our catalog and our website, or inquire of our local representative.				

Stand-alone Safety Control System

The stand-alone safety control system consists of an NX-EIC EtherNet/IP Coupler Unit, an NX-SL3300 Safety CPU Unit, NX Units, and an End Cover.

Up to 63 safety and standard I/O units can be connected, including up to 32 NX-series Safety I/O Units to a maximum of 256 safety I/O signals.

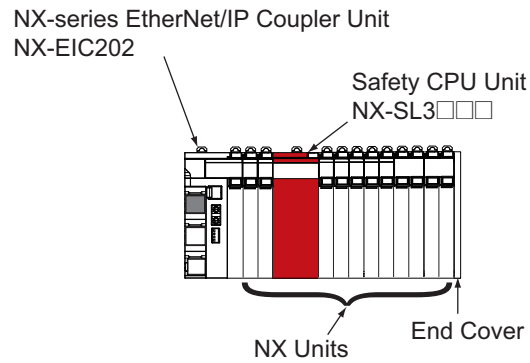

Refer to the *NX-series Safety Control Unit User's Manual* (Cat. No. Z930) for details on the stand-alone safety control system configuration.

Part Names and Functions

Safety CPU Unit NX-SL3300/SL3500

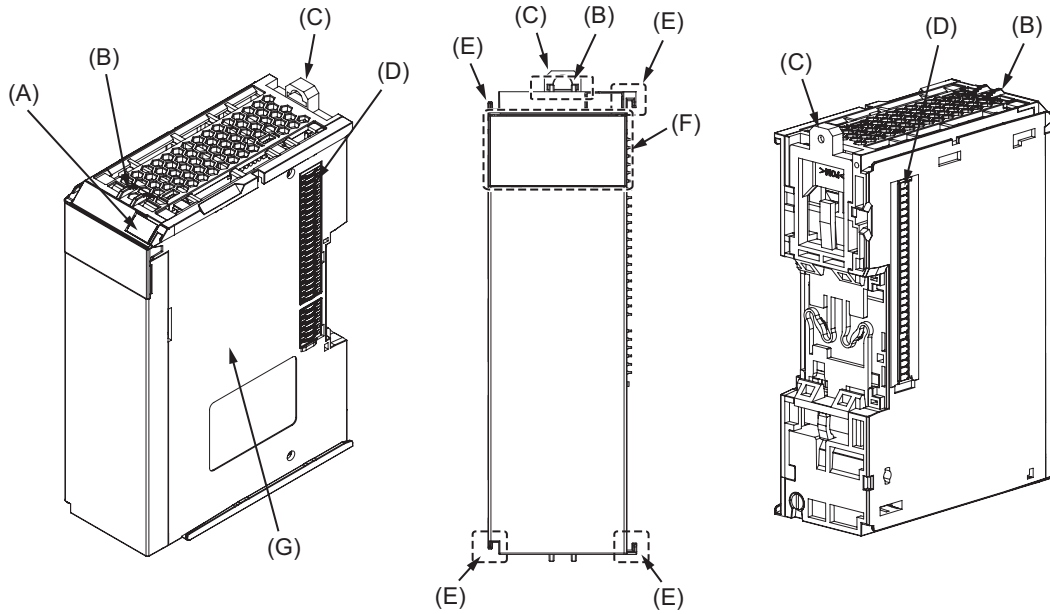

Letter	Item	Specification
(A)	Marker attachment locations	The locations where markers are attached. The markers made by OMRON are installed for the factory setting. Commercially available markers can also be installed.
(B)	Protrusions for removing the Unit	The protrusions to hold when removing the Unit.
(C)	DIN Track mounting hooks	These hooks are used to mount the NX Unit to a DIN Track.
(D)	NX bus connector	This is the NX-series bus connector. It is used to connect an NX-series Safety I/O Unit or other NX Unit.
(E)	Unit hookup guides	These guides are used to connect two Units.
(F)	Indicators	The indicators show the current operating status of the NX Unit or signal I/O status.
(G)	Unit specifications	The specifications of the NX Unit are given here.

Indicators



Letter	Name	Function
(A)	Model number display	Displays part of the model number of the Safety CPU Unit.
(B)	Indicators	The indicators show the current operating status and communications status of the Safety CPU Unit.

Indicator specifications

[TS] LED	The TS indicator shows the current operating status and communications status of the Safety CPU Unit.
[FS] LED	The FS indicator shows the safety communications status and safety function status of the Safety CPU Unit.
[RUN] LED	The RUN indicator shows the execution status of the safety programs.
[DEBUG] LED	The DEBUG indicator shows the status whether the debug function is executable on Safety CPU Unit.
[VALID] LED	The VALID indicator shows whether safety validation has been performed.

Dimensions

Safety CPU Unit NX-SL3300/SL3500

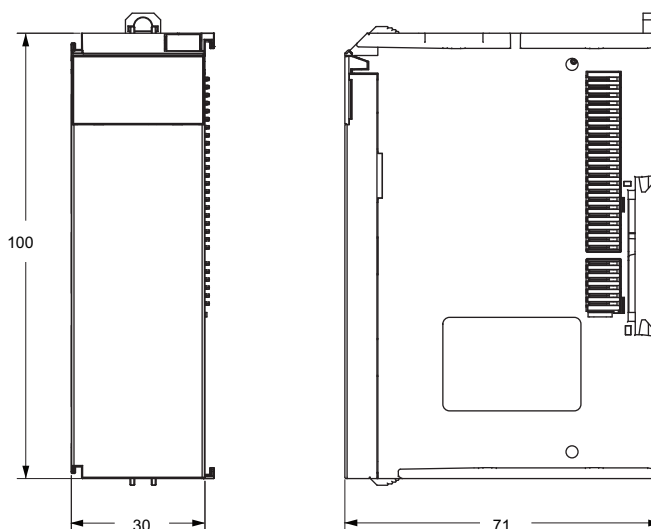

Related Manuals

Cat. No.	Model number	Manual name	Application	Description
Z930	NX-SL□□□□ NX-SI□□□□ NX-SO□□□□	NX-series Safety Control Unit User's Manual	Learning how to use NX-series Safety Control Units.	Describes the hardware, setup methods, and functions of the NX-series Safety Control Units.
Z931	NX-SL□□□□	NX-series Safety Control Unit Instructions Reference Manual	Learning about the specifications of instructions for the Safety CPU Unit.	Describes the instructions for the Safety CPU Unit. When programming, use this manual together with the <i>NX-series Safety Control Units User's Manual</i> (Cat. No. Z930).

Safety Precautions

Be sure to read the *Common Precautions for Safety Warning* at the following URL: <http://www.ia.omron.com/>.
Be sure to read the following user's manual for other details required for correct use of the Safety CPU Unit.

Terms and Conditions Agreement

Read and understand this catalog.

Please read and understand this catalog before purchasing the products. Please consult your OMRON representative if you have any questions or comments.

Warranties.

(a) Exclusive Warranty. Omron's exclusive warranty is that the Products will be free from defects in materials and workmanship for a period of twelve months from the date of sale by Omron (or such other period expressed in writing by Omron). Omron disclaims all other warranties, express or implied.

(b) Limitations. OMRON MAKES NO WARRANTY OR REPRESENTATION, EXPRESS OR IMPLIED, ABOUT NON-INFRINGEMENT, MERCHANTABILITY OR FITNESS FOR A PARTICULAR PURPOSE OF THE PRODUCTS. BUYER ACKNOWLEDGES THAT IT ALONE HAS DETERMINED THAT THE PRODUCTS WILL SUITABLY MEET THE REQUIREMENTS OF THEIR INTENDED USE.

Omron further disclaims all warranties and responsibility of any type for claims or expenses based on infringement by the Products or otherwise of any intellectual property right. (c) Buyer Remedy. Omron's sole obligation hereunder shall be, at Omron's election, to (i) replace (in the form originally shipped with Buyer responsible for labor charges for removal or replacement thereof) the non-complying Product, (ii) repair the non-complying Product, or (iii) repay or credit Buyer an amount equal to the purchase price of the non-complying Product; provided that in no event shall Omron be responsible for warranty, repair, indemnity or any other claims or expenses regarding the Products unless Omron's analysis confirms that the Products were properly handled, stored, installed and maintained and not subject to contamination, abuse, misuse or inappropriate modification. Return of any Products by Buyer must be approved in writing by Omron before shipment. Omron Companies shall not be liable for the suitability or unsuitability or the results from the use of Products in combination with any electrical or electronic components, circuits, system assemblies or any other materials or substances or environments. Any advice, recommendations or information given orally or in writing, are not to be construed as an amendment or addition to the above warranty.

See <http://www.omron.com/global/> or contact your Omron representative for published information.

Limitation on Liability; Etc.

OMRON COMPANIES SHALL NOT BE LIABLE FOR SPECIAL, INDIRECT, INCIDENTAL, OR CONSEQUENTIAL DAMAGES, LOSS OF PROFITS OR PRODUCTION OR COMMERCIAL LOSS IN ANY WAY CONNECTED WITH THE PRODUCTS, WHETHER SUCH CLAIM IS BASED IN CONTRACT, WARRANTY, NEGLIGENCE OR STRICT LIABILITY.

Further, in no event shall liability of Omron Companies exceed the individual price of the Product on which liability is asserted.

Suitability of Use.

Omron Companies shall not be responsible for conformity with any standards, codes or regulations which apply to the combination of the Product in the Buyer's application or use of the Product. At Buyer's request, Omron will provide applicable third party certification documents identifying ratings and limitations of use which apply to the Product. This information by itself is not sufficient for a complete determination of the suitability of the Product in combination with the end product, machine, system, or other application or use. Buyer shall be solely responsible for determining appropriateness of the particular Product with respect to Buyer's application, product or system. Buyer shall take application responsibility in all cases.

NEVER USE THE PRODUCT FOR AN APPLICATION INVOLVING SERIOUS RISK TO LIFE OR PROPERTY OR IN LARGE QUANTITIES WITHOUT ENSURING THAT THE SYSTEM AS A WHOLE HAS BEEN DESIGNED TO ADDRESS THE RISKS, AND THAT THE OMRON PRODUCT(S) IS PROPERLY RATED AND INSTALLED FOR THE INTENDED USE WITHIN THE OVERALL EQUIPMENT OR SYSTEM.

Programmable Products.

Omron Companies shall not be responsible for the user's programming of a programmable Product, or any consequence thereof.

Performance Data.

Data presented in Omron Company websites, catalogs and other materials is provided as a guide for the user in determining suitability and does not constitute a warranty. It may represent the result of Omron's test conditions, and the user must correlate it to actual application requirements. Actual performance is subject to the Omron's Warranty and Limitations of Liability.

Change in Specifications.

Product specifications and accessories may be changed at any time based on improvements and other reasons. It is our practice to change part numbers when published ratings or features are changed, or when significant construction changes are made. However, some specifications of the Product may be changed without any notice. When in doubt, special part numbers may be assigned to fix or establish key specifications for your application. Please consult with your Omron's representative at any time to confirm actual specifications of purchased Product.

Errors and Omissions.

Information presented by Omron Companies has been checked and is believed to be accurate; however, no responsibility is assumed for clerical, typographical or proofreading errors or omissions.

OMRON's Products Support IoT for Control Panels and Production Lines

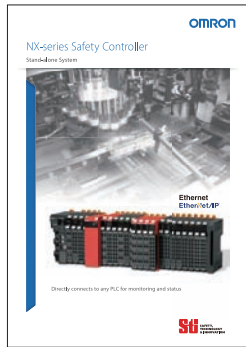

NX-series Safety Controller Stand-alone System Brochure

Cat. No. F100



NX-series Safety Controller EtherCAT System Brochure

Cat. No. F101



Safety I/O Unit NX-SI/SO Datasheet

Cat. No. F123



NX1 Machine Automation Controller Brochure

Cat. No. P129



NX1 Machine Automation Controller Datasheet

Cat. No. P130



NX-series I/O System Brochure

Cat. No. R183



NX-series EtherCAT Coupler Unit Controller NX-ECC Datasheet

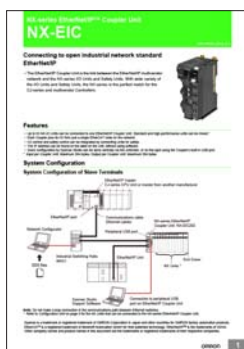

NX-series EtherNet/IP™ Coupler Unit NX-EIC Datasheet

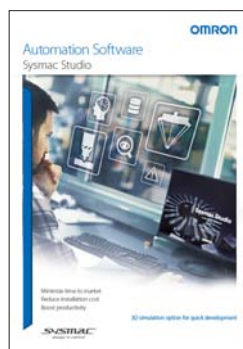

Automation Software Sysmac Studio Brochure

Cat. No. P138



Automation Software Sysmac Studio Ver.1.□□ Datasheet

Note: Do not use this document to operate the Unit.

OMRON Corporation Industrial Automation Company

Kyoto, JAPAN

Contact : www.ia.omron.com

Regional Headquarters

OMRON EUROPE B.V.

Wegalaan 67-69, 2132 JD Hoofddorp
The Netherlands
Tel: (31) 2356-81-300 Fax: (31) 2356-81-388

OMRON ELECTRONICS LLC

2895 Greenspoint Parkway, Suite 200
Hoffman Estates, IL 60169 U.S.A.
Tel: (1) 847-843-7900 Fax: (1) 847-843-7787

OMRON ASIA PACIFIC PTE. LTD.

438B Alexandra Road, #08-01/02 Alexandra
Technopark, Singapore 119968
Tel: (65) 6835-3011 Fax: (65) 6835-3011

OMRON (CHINA) CO., LTD.

Room 2211, Bank of China Tower,
200 Yin Cheng Zhong Road,
PuDong New Area, Shanghai, 200120, China
Tel: (86) 21-6023-0333 Fax: (86) 21-5037-2388

Authorized Distributor:

©OMRON Corporation 2020-2024 All Rights Reserved.
In the interest of product improvement,
specifications are subject to change without notice.

CSM_1_5

Cat. No. F109-E1-05 0524 (0920)