

# PRODUCT DATASHEET

## PL CMFT 625 P 28W 840 U19 DALIVR

PANEL COMFORT 625 UGR<19 DALI | Square recessed panel luminaire with low glare, for 625 x 625 mm ceiling systems and DALI-2 IoT technology

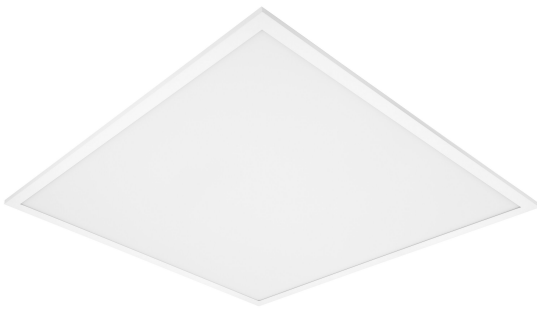

### Areas of application

- Direct replacement for recessed luminaires with fluorescent lamps
- Offices, conference rooms
- Reception areas, foyers, corridors, elevators
- Suitable for recessed ceiling systems with grid size of 625 x 625 mm

### Product benefits

- Suitable luminaire for VIVARES and other DALI-2 Light Management Systems
- Tool-free electrical connection due to push button connector
- Through-wiring possible with included connector box
- Energy savings thanks to high system efficacy: up to 130 lm/W
- Good glare reduction (UGR < 19)
- High color consistency with SDCM 3
- Extended services such as energy monitoring and remote maintenance possible with DALI versions
- External driver for extended flexibility and easy installation
- Low flicker light thanks to special electronic control gear
- Suitable for emergency lighting
- 5 years guarantee

### Product features

- IoT-ready luminaire with DALI-2 technology



- Suitable for central battery emergency installations acc. to EN 60598-2-22
- Push DIM function for dimming and switching directly on a pushbutton
- Versions available with CRI 90
- Extruded aluminum frame
- Polystyrene diffuser
- 5-pole terminal block, cable cross section up to 5 x 2.5 mm<sup>2</sup>
- Lifetime (L80/B10): 70,000 h (at 25 °C)

## TECHNICAL DATA

### Electrical data

Nominal wattage	28.00 W <sup>1)</sup>
Nominal voltage	220...240 V
Mains frequency	0/50/60 Hz
Nominal current	130.000 mA
Inrush current	4.4 A
Inrush current time T <sub>h50</sub>	440 µs
Max. number of luminaires per miniature circuit breaker B16	40
Max. number of luminaires per miniature circuit breaker C10	40
Max. number of luminaires per miniature circuit breaker C16	65
Power factor λ	> 0.90
Total harmonic distortion	< 20 %
Protection class	II
Operating mode	External LED driver

<sup>1)</sup> CR180 versions of the Panel Comfort family are fulfilling the technical minimum requirements according to the German BEG subsidy program for energy efficient luminaires

### Photometrical data

Luminous flux	3640 lm <sup>1)</sup>
Luminous efficacy	130 lm/W <sup>1)</sup>
Color temperature	4000 K
Light color (designation)	Cool White
Color rendering index Ra	> 80
Standard deviation of color matching	≤3 sdc <sub>m</sub>
Low flicker	Yes
Flickering metric (Pst LM)	<1
Stroboscope effect metric (SVM)	< 0.4
Photobiological safety group acc. to EN62778	RG0
Beam angle	90 °
UGR	< 19

<sup>1)</sup> CR180 versions of the Panel Comfort family are fulfilling the technical minimum requirements according to the German BEG subsidy program for energy efficient luminaires

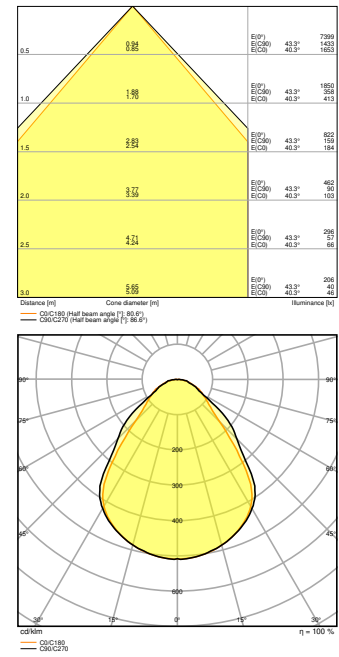
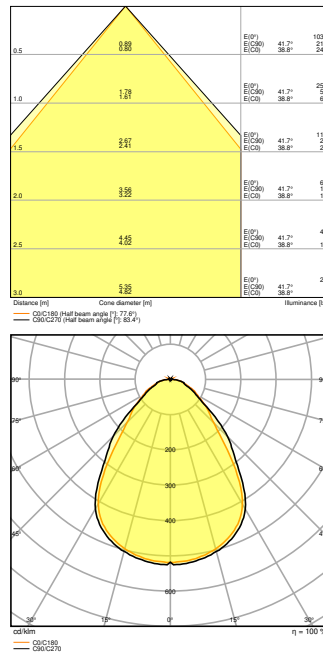
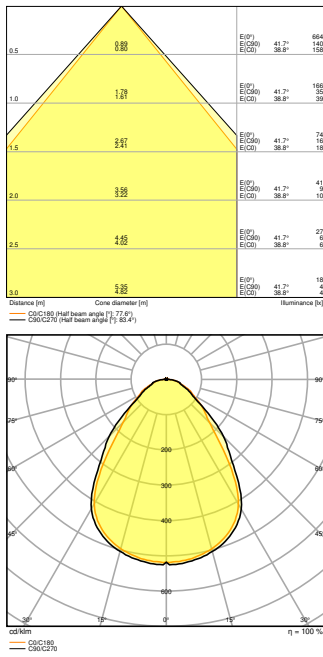

### Dimensions & Weight

Length	620.00 mm
Width	620.00 mm
Height	32.00 mm
Product weight	2000.00 g

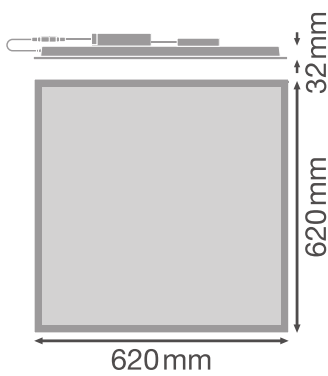

### Materials & Colors

Product color	White
---------------	-------

Housing color	White
Body material	Steel
Cover material	Polystyrene (PS)
Light emitting surface material	Polystyrene
Glow Wire Test according to IEC 60695-2-12	650 °C
Mercury content	0.0 mg

### Application & Mounting

Ambient temperature range	-10...+50 °C
Temperature range at storage	-20...+80 °C
Type of connection	Screwless terminal, 5-Pole (L, N, PE, DA+, DA-)
Type of protection	IP40/IP20
Protection class IK (shock resistance)	IK02
Dimmable	Yes
Type of dimming	DALI2
Mounting type	Recessed/Suspended/Surface
Mounting location	Ceiling
Application environment	Indoor
Mounting length	600,0 mm
Mounting width	600,0 mm
Mounting depth	50,0 mm
Adjustable	No
LED module replaceable	Not replaceable
With light source	Yes

### Lifespan

Lifespan L70/B50 at 25 °C	100000 h <sup>1)</sup>
Lifespan L80/B10 at 25 °C	70000 h <sup>1)</sup>
Lifespan L90/B10 at 25 °C	48000 h
Number of switching cycles	50000

<sup>1)</sup> t[h]: L70 / B50 @ 25 °C (Ta), t[h]: L80 / B10 @ 25 °C (Ta), t[h]: L90 / B10 @ 25 °C (Ta)

### Control gear

Output current	620 mA
ECG - Output ripple current	< 5 %
ECG - Length	209,00 mm

ECG - Width	42.5 mm
ECG - Height	30 mm
Recommended control gear	OSRAM OTI DALI 50/220-240/1A4 NFC; Tridonic LCA 45W 500-1400mA one4all SC PRE

### Emergency lighting

Wattage in emergency operation mode	5.5 W
Luminous flux in emergency operation mode	500 lm







### Certificates & Standards









Standards	CE / CB / ENEC / UKCA / EAC
Luminaire with limited surface temperature, "D sign"	No
Ball shot safe	No

### EQUIPMENT / ACCESSORIES

- Accessories for several mounting options available
- Connector box with 5-pole terminal included
- Security brackets preinstalled
- External control gear included
- Suitable for use with separate Emergency Conversion Box

### DOWNLOAD DATA

Documents and certificates	
	User instruction
	Addon Technical Information
	Declarations Of Conformity CE
	Declarations Of Conformity UKCA
Photometric and lighting design files	
	IES file (IES)
	LDT file (Eulumdat)

Photometric and lighting design files	
	ULD file (DIALux)
	ROLF file (RELUX)
	UGR file (UGR table)
	LDC typ cone
	LDC typ polar
CAD/BIM files	
	BIM_Revit_3D
	CAD_STEP_3D
Tender texts	
	Tender documents

### LOGISTICAL DATA

Product code	Packaging unit (Pieces/Unit)	Dimensions (length x width x height)	Gross weight	Volume
4099854014482	Folding box 1	52 mm x 647 mm x 719 mm	2427.00 g	24.19 dm <sup>3</sup>
4099854014499	Shipping box 4	672 mm x 227 mm x 749 mm	10933.00 g	114.26 dm <sup>3</sup>

The mentioned product code describes the smallest quantity unit which can be ordered. One shipping unit can contain one or more single products. When placing an order, for the quantity please enter single or multiples of a shipping unit.

### ADDITIONAL CATALOG INFORMATION

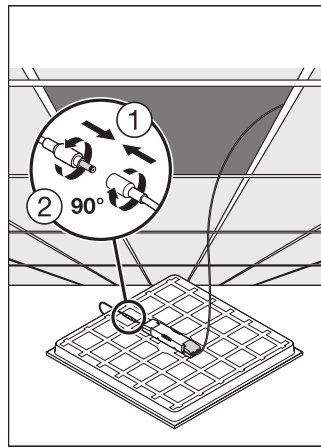
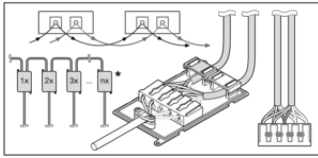

---

### References / Links

- For Guarantee see [www.ledvance.com/guarantee](http://www.ledvance.com/guarantee)

---

### DISCLAIMER

Subject to change without notice. Errors and omission excepted. Always make sure to use the most recent release.