

Product Data Sheet

GW66694

IB Range

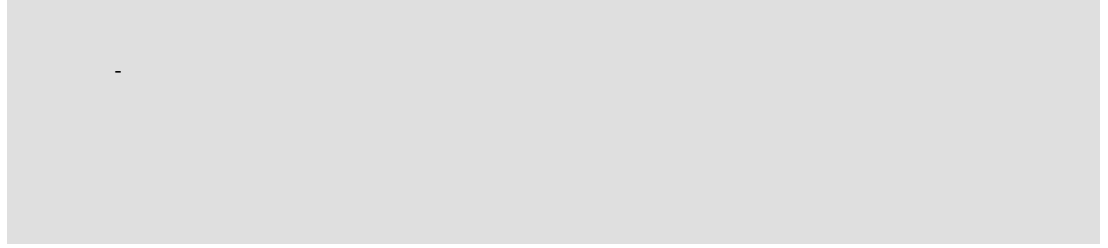

Top entries	5xØ 23	Glow Wire Test	650 °C
Houseable interloc. socket	3	IP degree	IP65
Mechanical resistance	IK08	Side entries	2xØ 23
Houseable IB socket-outlets	16/32 A	Electrocod	2221
Minimum installation temperature	-25°C		

DIMENSIONAL

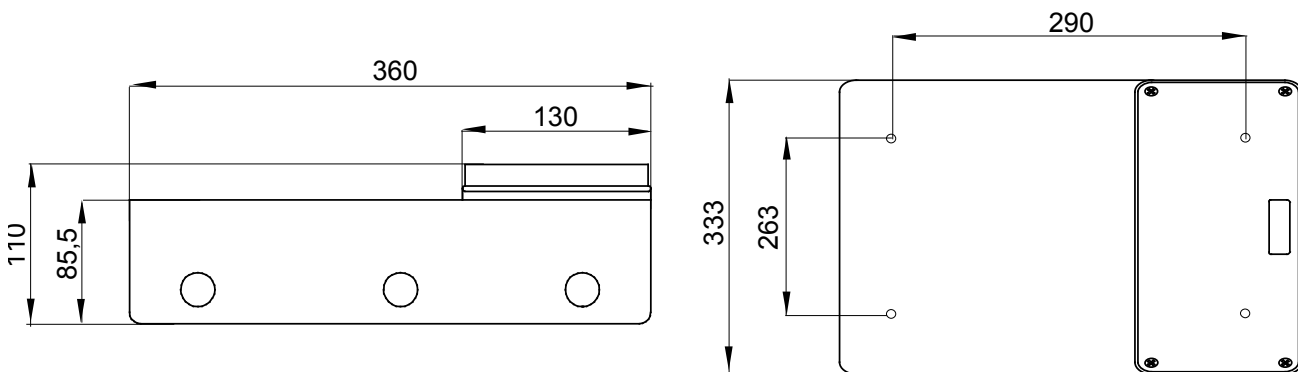

TECHNICAL SYMBOLOGY

GWT

650 °C

IP

IP65

IK

IK08

STANDARDS/APPROVALS

