

PRODUCT DATASHEET

SENSOR DALI-2 LIGHT/PRESENCE-40X5

INFRARED CEILING INTEGRATION

SENSOR DALI-2 LIGHT-PRESENCE-40X5 INFRARED CEILING INTEGRATION | DALI-2 input device, infrared presence detector with 40X5 m movement detection



Areas of application

- Corridors
- Stairways

Product benefits

- Light sensor up-to 2000 lx
- Quick and easy installation using spring clips
- Integrated DALI bus power supply (no mains connection required)
- Several sensors can be connected to a DALI line
- Can be integrated into lighting and building management systems that support DALI-2 sensors
- Compatible with LEDVANCE VIVARES DALI light management system
- Includes shutter accessory to optimize the sensor detection area

Product features

- DALI-2 certified light and presence sensor for ceiling installation
- Presence detection via passive IR element
- Detection height up to 4 m
- Large detection area for corridor applications up-to 40x5 m
- Function display with LED

TECHNICAL DATA

Electrical data

Nominal wattage	0.10 W
Nominal voltage	10...22,5 V
Mains frequency	0 Hz

Dimensions & Weight



Length	105.00 mm
Mounting hole spacing, length	66.00 mm
Width	105.00 mm
Height	67.00 mm
Diameter	105.00 mm
Cable cross-section, input side	1.0...2.5 mm ²
Wire preparation length, input side	6...8 mm
Product weight	119.00 g

Colors & materials

Product color	White
---------------	-------

Temperatures & operating conditions

Ambient temperature range	-20...+45 °C
Maximum temperature at tc test point	75 °C
Temperature range in operation	-20...+45 °C

Additional product data

Product remark	Available from September 2024
----------------	-------------------------------

Capabilities

Dimmable	No
Dimming interface	DALI-2
Maximum installation height	4 m
Detection area	40x5 m
Max. presence detection area	40x5 m
Detection angle	360 °

Type of installation	Ceiling integration
Operating range, light sensor	5...2000 lx

Certificates & Standards

Approval marks – approval	CE
Protection class	II
Type of protection	IP20



Accessories Optional

Product image	Product name	EAN
	SENSOR CEILING MOUNTING KIT	4058075843905

EQUIPMENT / ACCESSORIES

– Surface mounting via SENSOR CM KIT

DOWNLOAD DATA

Documents and certificates		Document name
	User instruction / safety instructions	SENSOR DALI 2 LS PD IR CI
	Legal information	Informationstext 18 Abs 4 ElektroG
	Declarations of conformity	SENSOR DALI 2 LS PD

Tender texts	Document name
 Tender documents	DALI-2 SENSORS LIGHTPRESENCE-40X5 INFRARED CEILING INTEGRATION-EN

LOGISTICAL DATA

Product code	Packaging unit (Pieces/Unit)	Dimensions (length x width x height)	Gross weight	Volume
4058075843868	Folding box 1	123 mm x 123 mm x 95 mm	229.00 g	1.44 dm ³
4058075843875	Shipping box 24	525 mm x 390 mm x 215 mm	6316.00 g	44.02 dm ³

The mentioned product code describes the smallest quantity unit which can be ordered. One shipping unit can contain one or more single products. When placing an order, for the quantity please enter single or multiples of a shipping unit.

ADDITIONAL CATALOG INFORMATION

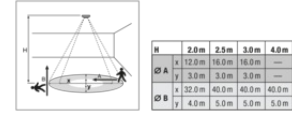
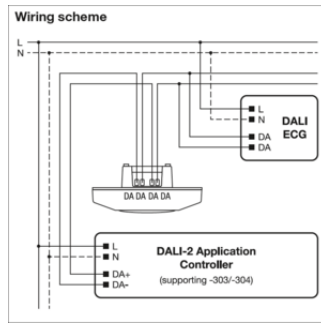
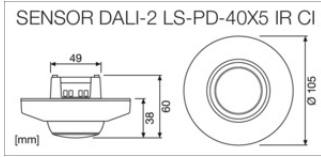

References / Links

– For current information see www.ledvance.com/light-management-systems

DISCLAIMER

Subject to change without notice. Errors and omission excepted. Always make sure to use the most recent release.