

BMSA2202

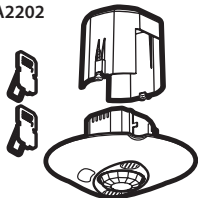

BMSA2202	
	100 - 240 V~
	50 / 60 Hz
	2 x 2,5 mm <sup>2</sup>
	(-5) - (+45) °C
	PIR / ULTRASONIC
	500 lux
	15 mm
	Ø 8 m

230 V~	2000 W	1000 VA	4,3 A	10x(2x36 W)	4,3 A	500 VA	2,1 A	1000 VA	4,3 A	500 VA	2,1 A	I max. ≤ 2A
110 V~	1000 W	500 VA		5x(2x36 W)		250 VA		500 VA		250 VA		

- (\*) Non collegare differenti tipologie di carico allo stesso prodotto
- (\*) Utilizzare solamente trasformatori progettati per funzionare con interruttori elettronici

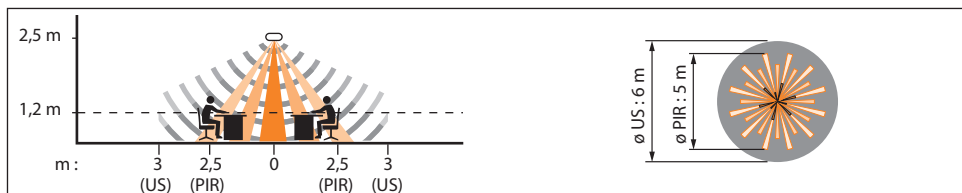
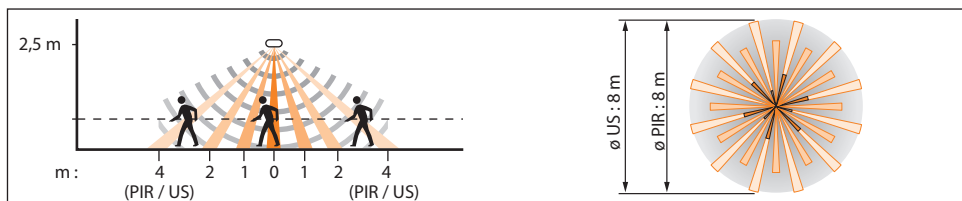

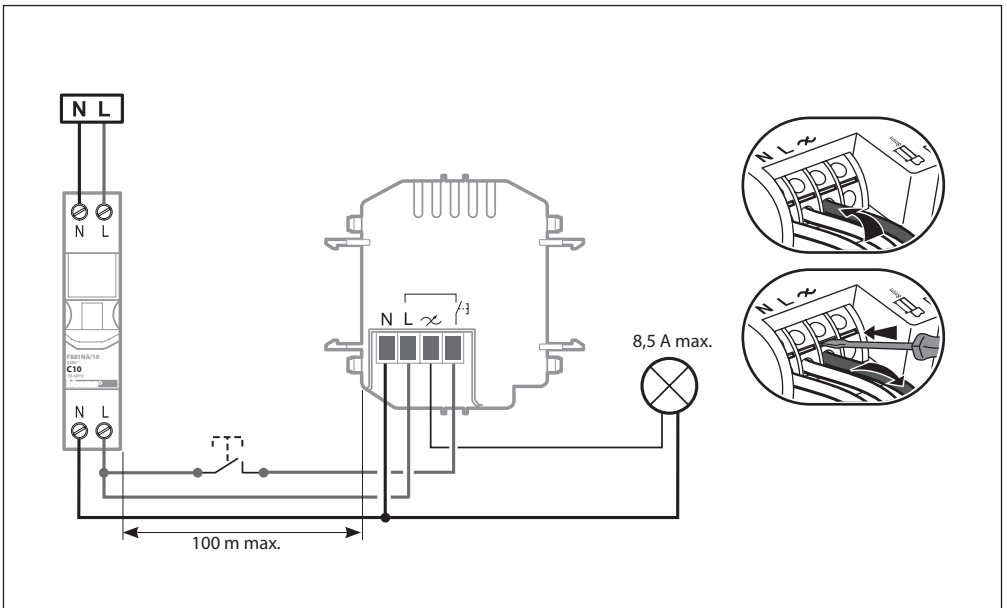
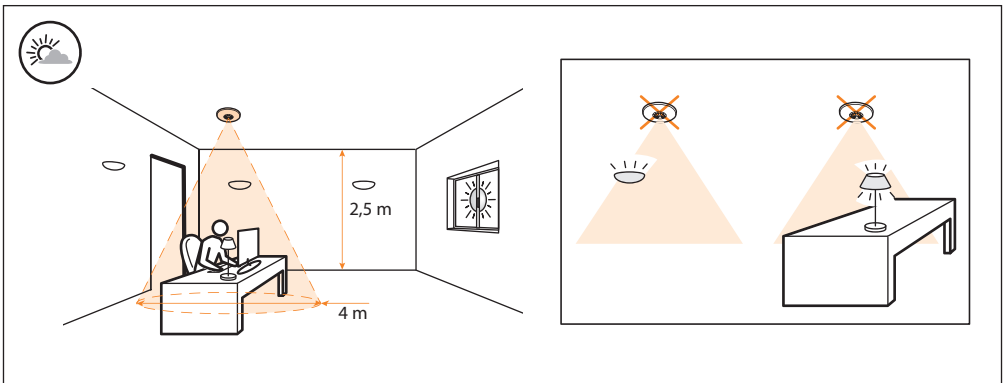
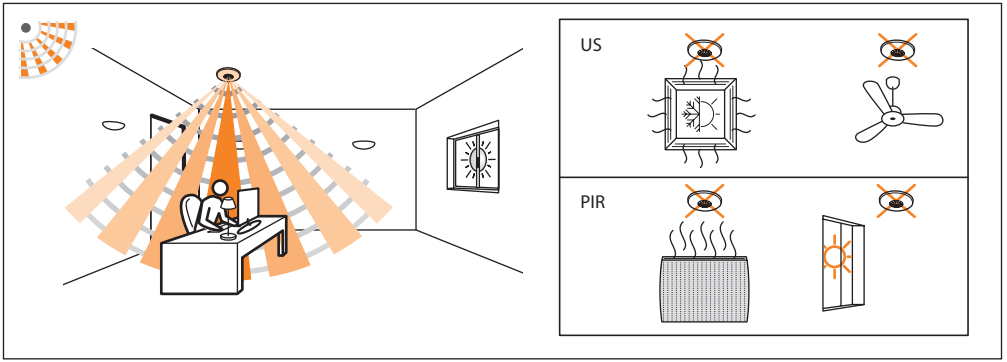

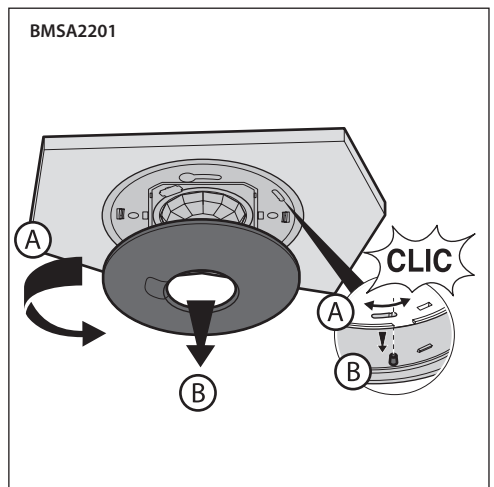
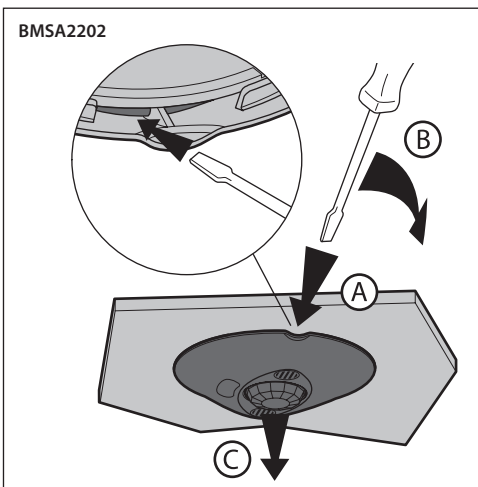
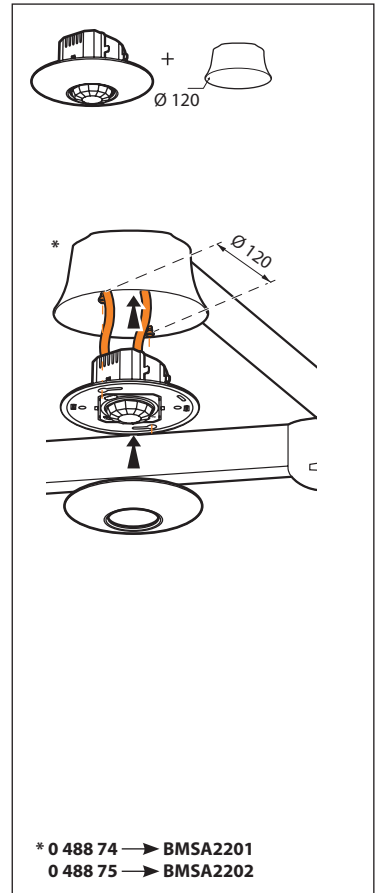
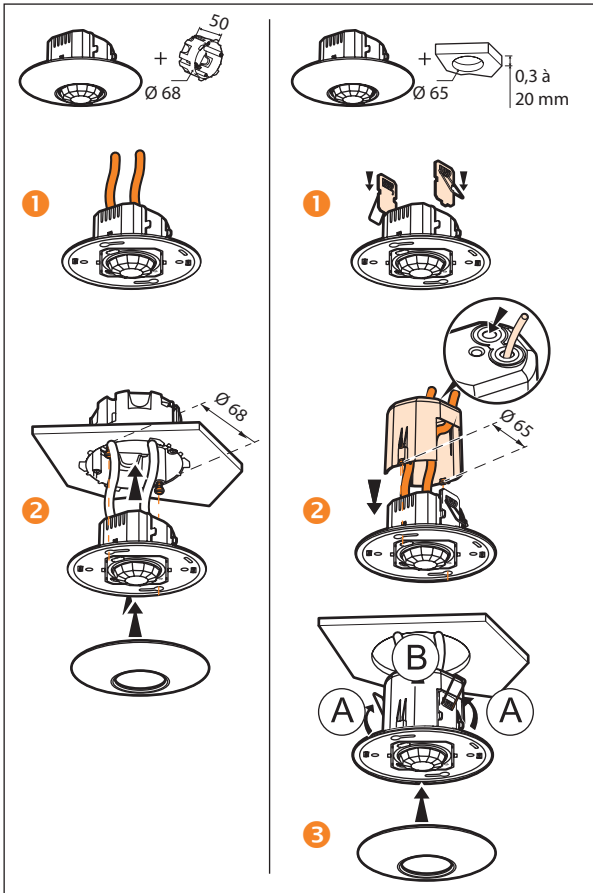

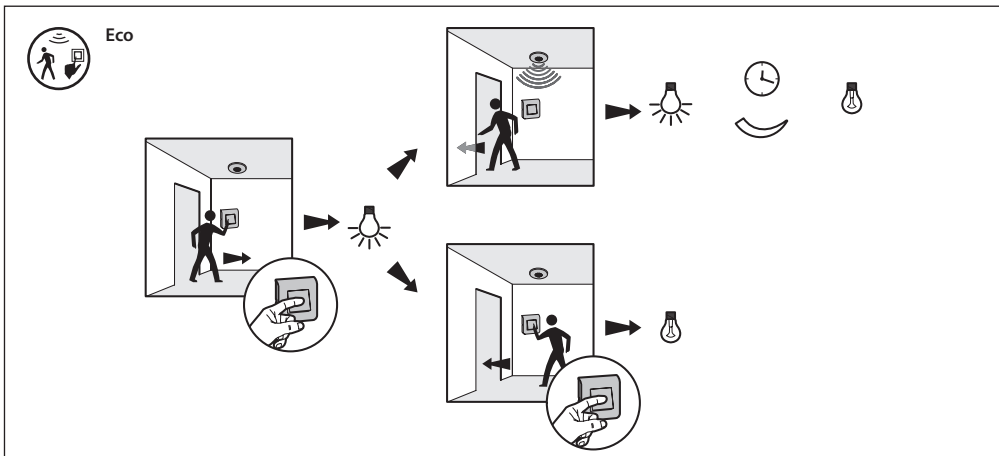
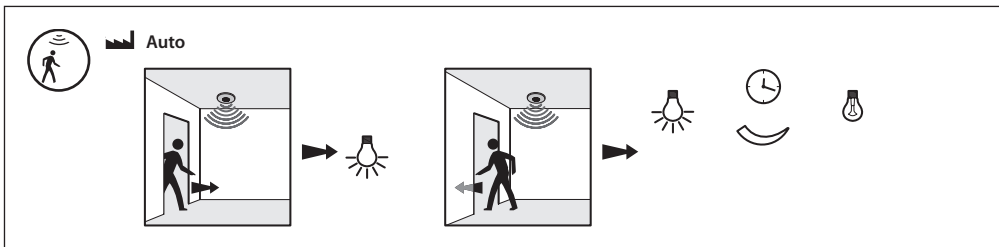



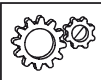

Al primo utilizzo: Scaricare l'app Legrand Close Up su Apple Store o Play Store.



Ref. 0 882 40: Gateway di configurazione





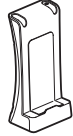

&



App: «Legrand Close Up»

Per maggiori informazioni sulle impostazioni, consultare la scheda tecnica del gateway di configurazione Ref. 0 882 40.

	5 - 1275 lux
	0 sec - 59 min 59 sec
	25% - 50% - 75% - 100% Bassa - Media - Alta - Massima
Modo	auto - eco - walkthrough

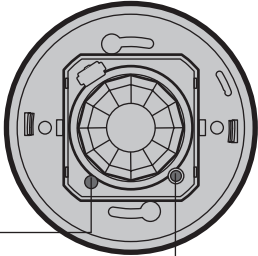

LEARN \_\_\_\_\_

LED IR \_\_\_\_\_