



**Automatic equipment for cutting and bending steel wire gangways**



**MV 51943**

**Use and maintenance manual**

---



**IDENTIFICATION DATA OF THIS MANUAL**

*Equipment serial number:* 600-1006 ÷ 600-1050

*Edition:* 09/2003

***Manufactured under patent by:***



***M.T.S. SpA***

Via Galvani, snc  
24061 Albano S. Alessandro (BG) - ITALY

*Telephone:* +39 035 58 11 91

*Fax:* +39 035 58 15 09

Via Volta, 5

25050 Provaglio D'Iseo (BS) – ITALY

*Telephone:* +39 030 98 31 78

*Fax:* +39 030 98 23 814

*e-mail:* mtsbgit@tin.it

*web:* <http://www.mts-italy.com>

***Distribution and technical support:***



***Patents owned by GEWISS S.p.A.***

***GEWISS S.p.A.***

Via A. Volta, 1  
24069 CENATE SOTTO (BG) - ITALY

*Telephone:* +39 035 94 61 11

*Fax:* +39 035 94 52 22

*e-mail:* [gewiss@gewiss.com](mailto:gewiss@gewiss.com)

*sat:* [sat@gewiss.com](mailto:sat@gewiss.com)

*web:* <http://www.gewiss.com>

## EC Conformity under the relevant European Directives

Here below there is an abstract of the **Declaration of Conformity**, in which **M.T.S. SpA** certifies that the following equipment:

<b>Type:</b>	<i>Speedy Curva</i>
<b>Model</b>	<i>MV 51943</i>
<b>Year of manufacture:</b>	<u><i>2003</i></u>
<b>Serial number:</b>	<u><i>600-1006 ÷ 600-1050</i></u>
<b>Product purpose:</b>	<i>Automatic equipment for cutting and bending steel wire gangways</i>

complies with these Directives:

- Directive 98/37/EC and D.P.R. 459/96 relating to Machines Safety.
- Directive 73/23/EEC relating to Electric Safety (*Low Voltage*) and further amendments brought in by Directive 93/68/EEC.
- Directive 89/336/EEC relating to Electromagnetic Compatibility and further amendments brought in by Directive 92/31/EEC and 93/68/EEC.

They also certify that in planning and manufacturing they followed principles and concepts brought in by relevant paragraphs in the following Matched Rules:

- EN 292.1
- EN 292.2
- EN 60204-1
- EN 954-1
- EN 50081-2
- EN 61000-6-2

Albano S. A., \_\_\_/\_\_\_/\_\_\_

the Legal Representative  
Colpani Ermanno

---



*The above mentioned data are only for information and cannot substitute the proper declaration of conformity signed and issued by the Manufacturer.*

## ***General Table of Contents***

### **Chapter 1 – Overview**

<b>1.1</b>	<b>General data on this manual.....</b>	<b>1.1</b>
<b>1.2</b>	<b>Ownership of information.....</b>	<b>1.2</b>
<b>1.3</b>	<b>Contents of this manual .....</b>	<b>1.3</b>
<b>1.4</b>	<b>Graphic symbols adopted .....</b>	<b>1.4</b>
1.4.1	GENERAL.....	1.4
1.4.2	PERSONAL SAFETY MEANS .....	1.4
1.4.3	DANGERS .....	1.5
1.4.4	PROHIBITIONS.....	1.5
1.4.5	TITLES AND NUMBER OF OPERATORS .....	1.5
1.4.6	MACHINE STATE .....	1.5
1.4.7	CONVENTIONS AND DEFINITIONS .....	1.6
<b>1.5</b>	<b>A reference guide.....</b>	<b>1.7</b>
<b>1.6</b>	<b>Warranty .....</b>	<b>1.8</b>
1.6.1	GENERAL CONDITIONS .....	1.8
1.6.2	PARTS EXCLUDED FROM THE WARRANTY.....	1.8
1.6.3	OPERATIONS THAT INVALIDATE THE WARRANTY.....	1.8
<b>1.7</b>	<b>Technical support.....</b>	<b>1.9</b>
1.7.1	REQUESTING TECHNICAL SUPPORT.....	1.9

### **Chapter 2 – General and technical data**

<b>2.1</b>	<b>General data and performances .....</b>	<b>2.1</b>
<b>2.2</b>	<b>General information about safety.....</b>	<b>2.2</b>
2.2.1	DIRECTIONS ON RESIDUAL RISKS. ....	2.2
2.2.2	SIGNALS RELATING TO POTENTIAL RISKS AND THEIR DISPLACEMENT.....	2.3
2.2.3	WORKING AREA AND SAFETY POSITION OF THE OPERATOR .....	2.4
2.2.4	DIRECTIONS ON EMITTED NOISE.....	2.5
2.2.5	PROPER AND IMPROPER USE .....	2.5
2.2.6	DIRECTIONS AND RULES OF BEHAVIOUR .....	2.7
<b>2.3</b>	<b>Technical data and specifications.....</b>	<b>2.9</b>
2.3.1	OVERALL DIMENSIONS AND LOCATION OF THE IDENTIFICATION PLATE .....	2.9
<b>2.4</b>	<b>Technical data .....</b>	<b>2.10</b>
2.4.1	GENERAL SPECIFICATIONS.....	2.10
2.4.2	PERFORMANCES .....	2.10
2.4.3	ELECTRIC SYSTEM.....	2.10
2.4.4	HYDRAULIC BOX .....	2.10
2.4.5	Standard EQUIPMENT .....	2.10

## Chapter 3 – Installation and connection

<b>3.1</b>	<b>Residual risks during lifting and transport</b> .....	<b>3.1</b>
<b>3.2</b>	<b>Residual risks during positioning and connection</b> .....	<b>3.2</b>
<b>3.3</b>	<b>Introduction</b> .....	<b>3.2</b>
<b>3.4</b>	<b>Installation seat</b> .....	<b>3.3</b>
<b>3.5</b>	<b>Unpacking, lifting and transport</b> .....	<b>3.4</b>
<b>3.6</b>	<b>Positioning</b> .....	<b>3.8</b>
3.6.1	FASTENING .....	3.8
3.6.2	OPENING AND CLOSING OF THE COLLAPSIBLE FACES .....	3.8
<b>3.7</b>	<b>Link and connection</b> .....	<b>3.10</b>
3.7.1	ELECTRIC SYSTEM LINK.....	3.10
3.7.2	CONTROL PEDAL CONNECTION .....	3.11
<b>3.8</b>	<b>Storage</b> .....	<b>3.12</b>
<b>3.9</b>	<b>First setting at work</b> .....	<b>3.12</b>
3.9.1	MOTOR SENSE OF ROTATION CHECK.....	3.13

## Chapter 4 – Control Devices and working procedure

<b>4.1</b>	<b>Residual risks during setting at work and use</b> .....	<b>4.1</b>
<b>4.2</b>	<b>Control and signal devices</b> .....	<b>4.1</b>
<b>4.3</b>	<b>Working procedure</b> .....	<b>4.3</b>
4.3.1	MACHINE STARTING.....	4.3
4.3.2	CUTTING OPERATION.....	4.3
4.3.2.1	<i>Possible cuts</i> .....	4.5
4.3.2.2	<i>Important notes on cutting operation</i> .....	4.7
4.3.2.3	<i>Description of the cutting station and description of the cutting cycle</i> ....	4.8
4.3.2.4	<i>Arrangement of cutting station</i> .....	4.9
4.3.2.5	<i>Top/tail cut</i> .....	4.10
4.3.2.6	<i>Cut for making sharp quarter bends</i> .....	4.13
4.3.2.7	<i>Cut for making quarter bends/angles</i> .....	4.14
4.3.2.8	<i>Cut for making Tee joints</i> .....	4.15
4.3.2.9	<i>Cut for making 100/200 mm neckings</i> .....	4.17
4.3.2.10	<i>Cut for making Up and/or Downgrade bends</i> .....	4.18
4.3.2.11	<i>Drawing wires from cutting station in case of wrong insertion</i> .....	4.18
4.3.2.12	<i>Emptying of the box for scraps</i> .....	4.19
4.3.2.13	<i>End of cutting operation</i> .....	4.20

4.3.3	BENDING OPERATION .....	4.21
4.3.3.1	<i>Important notes on bending operations</i> .....	4.21
4.3.3.2	<i>Description of the bending station and description of the bending cycle</i> .....	4.22
4.3.3.3	<i>Arrangement of the bending station</i> .....	4.24
4.3.3.4	<i>Bending operations for gangways from 50 mm to 500 mm long</i> .....	4.33
4.3.3.5	<i>Bending operations for 600 mm gangways</i> .....	4.39
4.3.3.6	<i>End of bending operations</i> .....	4.43
4.3.4	MACHINE SWITCHING OFF .....	4.45
4.3.5	EMERGENCY STOP OF THE CYCLE.....	4.45
4.3.6	DEFAULTS CONDUCT.....	4.45
4.3.7	VOLTAGE DROP.....	4.46

## Chapter 5 - Maintenance

<b>5.1</b>	<b>Residual risks during maintenance</b> .....	<b>5.1</b>
<b>5.2</b>	<b>Maintenance data</b> .....	<b>5.2</b>
5.2.1	GENERAL INSTRUCTIONS.....	5.3
5.2.1.1	<i>Check of Material</i> .....	5.3
<b>5.3</b>	<b>Operation of ordinary maintenance</b> .....	<b>5.4</b>
5.3.1	MECHANICAL PARTS .....	5.5
5.3.1.1	<i>Control of bolts and nuts clamping (monthly)</i> .....	5.5
5.3.1.2	<i>Cleaning and lubrication (each shift)</i> .....	5.5
5.3.1.3	<i>Greasing of bending station (monthly)</i> .....	5.9
5.3.1.4	<i>Control of metallic parts wearing (monthly)</i> .....	5.11
5.3.2	HYDRAULIC BOX .....	5.14
5.3.2.1	<i>Control of the oil level (monthly)</i> .....	5.14
5.3.3	ELECTRICAL SYSTEM.....	5.15
5.3.3.1	<i>Check of cables integrity and connectors fixing (six-monthly)</i> .....	5.15
5.3.3.2	<i>Check of functioning of devices and signal lamp (six-monthly)</i> .....	5.15
5.3.3.3	<i>Fuses replacement and protection thermal relay refit (at breaking)</i> .....	5.16
<b>5.4</b>	<b>Extraordinary maintenance operations</b> .....	<b>5.18</b>
5.4.1	BENDING STATION SETTING .....	5.18
<b>5.5</b>	<b>Disassembly and demolition</b> .....	<b>5.20</b>
5.5.1	DISASSEMBLY OF THE MACHINE .....	5.20
5.5.2	DEMOLITION.....	5.20
<b>5.6</b>	<b>Annexes</b> .....	<b>5.22</b>

**Annex 1 – Bending parameters**

**Annex 2 – Electrical diagram**

**Annex 3 – Hydraulic diagram**

**Annex 4 – Bending station**

**Annex 5 – Cutting station**



## ***1.1 General data on this manual***


This manual is for operators and technicians working at “*Speedy Curva*” machine, through all its life steps, which is manufactured by **M.T.S. SpA** under GEWISS S.p.A patent and copyright.


The purpose of this manual is to give to the above mentioned personnel all necessary information and instructions to work in security.

This manual is not to be considered a mere reference book, but a manual of preliminary instruction which must be used compulsory to train personnel that will work at the machine and/or will keep it working.

Even though are pointed out all instructions for a right use of the machine by the operator or to allow personnel in charge of maintenance to service it properly, this document implies that in the rooms where the machine is set up are observed the safety and sanitary rules in force and that the personnel operating and/or servicing machine is really skilled and can properly understand all information.

Drawings, diagrams and technical data carried in this document are revised at the date of publication and are valid only for the equipment to which they are attached.

 *We remind You that it is necessary to keep this instruction manual with care and in a known and easily accessible place.*

 *If necessary, the User can ask for a copy of this document (for instance in case of damage of the original document) by written request to the machine Distributor.*

## ***1.2 Ownership of information***

This manual contains proprietary information.

All rights are reserved.

This manual may not be reproduced or photocopied, wholly or partly, without the prior written consent of the manufacturer. It may be used only by the customer to whom it has been supplied together with the machine and only for the purposes of installation, use and maintenance of the machine to which the manual refers.

The manufacturer declares that the information contained in this manual is coherent with the technical and safety specifications of the machine to which the manual refers. The manufacturer accepts no liability for direct or indirect injury to persons or pets or damage to property resulting from the use of this manual or the machine in conditions other than those specified.

The manufacturer reserves the right to modify or improve this manual or the machine without prior notice. Drawings, diagrams and technical data carried in this document are revised at the date of publication and are valid only for the equipment to which they are attached.

## 1.3 Contents of this manual

This use and maintenance manual is addressed to operators and skilled personnel for a right use of the machine to which it refers. Inside it, operators and skilled technicians appointed for the machine use and maintenance will find not only a functional description of machine and its main parts, but also instructions and directions for:

- a right transport and installation;
- a right use;
- right cleaning, adjustment and scheduled maintenance;
- paying attention to the simplest safety and injury rules.

Here below there is a description of contents in the manual chapters.

**Chapter 1 - Overview** (this Chapter) carries directions for this manual use and it describes its structure.

*Chapter addressed to all personnel entrusted with machine operation.*

**Chapter 2 – General and technical data** carries general directions on this machine, on chosen solutions for working personnel protection as well as general warnings in order to use machine properly. It carries also the main technical data on this machine.

*Chapter addressed to all personnel entrusted with machine operation.*

**Chapter 3 – Installation and connection** carries directions on the best seat for machine installation, on its lifting and transport as well as directions for electrical connection. This chapter carries also directions for a possible storage and setting at work (*first starting*) of the machine and residual risks during these steps of machine life.

*Chapter addressed to: Operator, Maintenance engineer and Technician of the Manufacturer.*

**Chapter 4 – Control devices and working procedure** carries a description of the control devices set up, as well as the procedure to be followed in order to carry out the start, stop, emergency stop and all other operations necessary to run the machine.

*Chapter addresses to ALL personnel entrusted with machine operation.*

**Chapter 5 - Maintenance** carries procedures for checking working/setting and replacement of wearing parts. This chapter carries also directions for machine disassembling and scrapping and the residual risks during these steps of machine life.

*Chapter addressed MAINLY to: Operator, Maintenance engineer and Technician of the Manufacturer.*

## ***1.4 Graphic symbols adopted***

### **1.4.1 General**



*It shows warnings, notes, suggestions and other hints to whom they want to draw the reader's attention.*



*It shows operations to be **COMPULSORY** carried out or information to which pay peculiar attention to avoid possible risks.*



*It shows those activities to be carried out by a simple but necessary visual control.*

### **1.4.2 Personal Safety Means**



*It shows the necessity to use safety gloves fit to carry out the described operation.*



*It shows the necessity to use safety clothes fit to carry out the described operation.*



*It shows the necessity to use a faceplate to carry out the described operation*



*It shows the necessity to use safety shoes to carry out the described operation*



*It shows the necessity to use a safety helmet to carry out the described operation*

### 1.4.3 Dangers



*It shows the danger of crushing arms.*

### 1.4.4 Prohibition



*It shows the prohibition to lubricate mechanical members in motion*



*It shows the prohibition to be used by not attached operators*

### 1.4.5 Titles and number of operators required



*Qualified, skilled operator*



*Skilled maintenance man/electrician*



*Manufacturer's technician*

*The number of times in which one of the above mentioned symbols is repeated shows the number of people necessary to carry out the operation thereof (if it is not otherwise specified it implies the presence of only one Operator).*

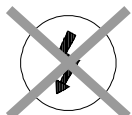
### 1.4.6 Machine State



Stop



Emergency stop



Electric system sectioning

### 1.4.7 Conventions and definitions

**Machine:** It is Speedy Curva to which this manual is referred.

**PPD:** Personal Protection Device.

**Operator's position:** as regards directions on the position (for example in the description of figures) we underline that we conventionally refer to the operator; if in the text it is written LEFT, it is meant to be the operator's left in his work position; if in the text it is written RIGHT, it is meant to be the operator's right in his work position. The work position at machine is that one connected with the control panel on the machine.

**Qualified personnel:** persons who, on the basis of their professional training and experience, possess sufficient knowledge of the regulations to be observed and are also able to assess safety conditions in relation to the work to be carried out and recognise any hazards connected with performance of the required operations.

#### Gangway and its parts:

Width: **1**

Length: **2**

Transversal wires: **3**

Base longitudinal wires: **4**

Side longitudinal wires: **5**

Sector: **6**

Double wire: **7**

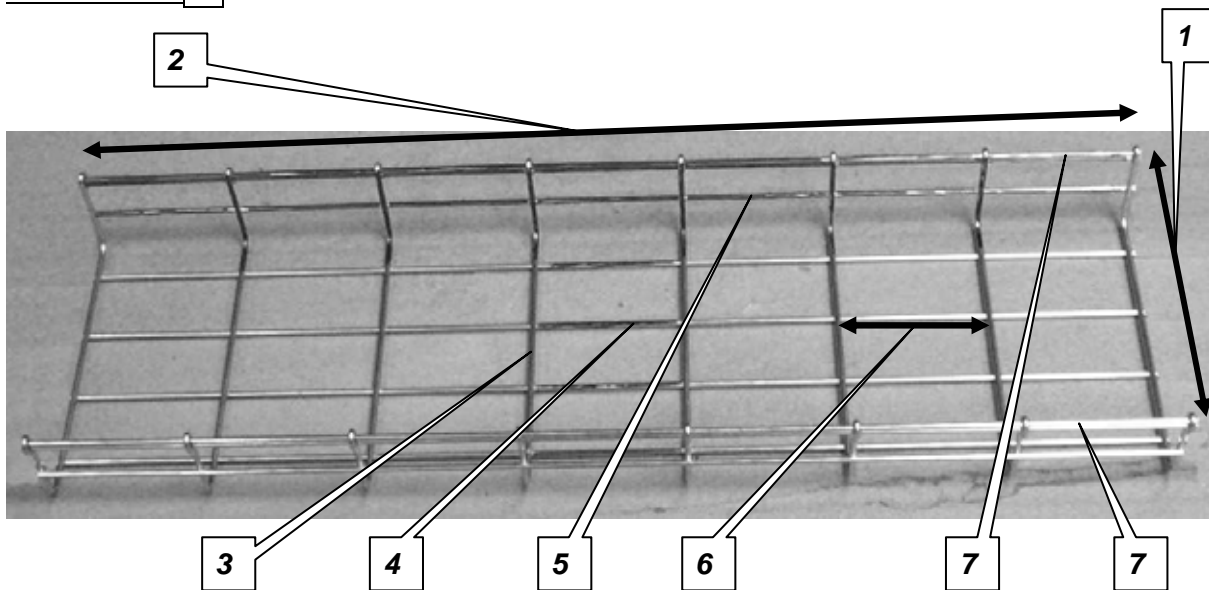


Fig. 1.1 – Gangway and its parts

## 1.5 A reference guide

To simplify the information retrieval, this manual is divided into chapters, easily identifiable by looking up in General Table of Contents. The system of page numbering considers this subdivision, showing first of all the number of chapter and then, after a point, the number of page inside the chapter. The same convention is adopted for numbering figures. Even skimming through the manual, You can easily find not only the number of page but also the subject of the chapter, paragraphs and cross reference marks.

Number and title of chapter

Title of paragraph

Figure keys

Number and figure description

Identificator n° and personnel title

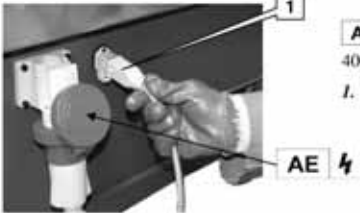
Subtitle in paragraph

**3 - INSTALLATION AND CONNECTION**

**3.7 Link and connection**

To perform a right arrangement at the installation of the machine it is necessary:

- to arrange the electric system line in order to reach the chosen connecting point, stated in fig. 3.12;
- to connect the control pedal as stated in fig. 3.12.




Electric system line input – 400 V 3P + T 16 A

1. Control pedal link point

Fig. 3.12 –Link and connection points

**3.7.1 Electric system link**

The system is equipped with a power plug of industrial type adequately dimensioned with ground pole to guarantee the full grounding of the machine. For the electric system is sufficient then to arrange an electric outlet able to deliver electric energy at specified voltage and frequency and suitable to the absorbed power of the system (see section "Technical data" in Chapter 2).

 The electric equipping installed on the equipment is foreseen to work rightly with the specified voltage and amperage.

Keep also to the following warnings:

- ✓ If the installed power plug and outlet are incompatible, let the outlet be replaced with another of suitable type by qualified personnel. Usually, it is not advisable to utilise adapters, multiple outlets and/or extensions.
- ✓ It is advisable to install a suitable disconnecting switch with relative electric protections above the power supply link point of the equipment, in order to isolate the last one without unplugging the power plug.
- ✓ Make sure that the amperage of the current meter is suitable for the absorption system.
- ✓ The electric system connected to the equipment in subject must be realised in accordance with the regulations in force and must be suitably grounded to avoid the possibility of electric shock or damages to the equipment.

**3.10**

N° Chapter + N° Page

## **1.6 Warranty**

### **1.6.1 General condition**

Speedy Curva is covered by the warranty for 1 (one) year, with the exception of wearing expendable parts. The warranty period starts from the date of delivery to the user.

In the event of malfunctioning during the warranty period, GEWISS S.p.A. undertakes to repair or replace free of charge all faults and defects in material and/or workmanship in the time necessary, even considering in special cases the complete replacement of Speedy Curva.

In case the user needs technical support at its own premises, GEWISS S.p.A. will quantify and notify travelling expenses for the approval by the user, who will pay for them.

It is understood that, upon intervention under warranty, GEWISS S.p.A. will verify the malfunctioning mourned by the user in order to check the faulty origin of the supply or the misuse of Speedy Curva.

Anyway, GEWISS S.p.A. guarantees the necessary technical support to the user even after the warranty period. In this case the expenses for interventions, at the premises of GEWISS S.p.A. or the user's, will be paid by the user.

### **1.6.2 Parts excluded from the warranty**

Are excluded from the warranty all tools and wearing expendable parts, supplied by the manufacturer together with the machine.

### **1.6.3 Operation that invalidate the warranty**

Any attempt of disassembling, altering or tampering with a machine component by the user or by non authorised personnel invalidates the warranty and relieves GEWISS S.p.A. of any responsibility on possible damages to people or things resulting from that tampering.

GEWISS S.p.A. is relieved from any responsibility and invalidates the warranty on machine if the following cases occur:

- ✓ unscheduled uses of the machine (see Paragraph 2.3.5 – “*Proper and improper use*” in Chapter 2 – “*General and technical data*”);
- ✓ use different from the one required by rules in force in the user's country;
- ✓ machine installation in conditions other than those specified in Chapter 3 “*Installation and connection*”;
- ✓ connections not in compliance with the specifications indicated in Chapter 3 – “*Installation and connection*”;
- ✓ total or partial non-compliance with instructions carried in this Manual;
- ✓ wrong or not carried out at all maintenance;
- ✓ use of spare parts not-original or not specified by GEWISS S.p.A.



## ***1.7 Technical support***

As regards use of the machine to its full capacity and extraordinary maintenance operations, this manual cannot replace the experience of trained qualified installers, users and maintenance personnel. The customer technical support service provides information by telephone and post in addition to training and maintenance services.

### **1.7.1 Requesting technical support**

Technical support service

Please contact:

**GEWISS S.p.A.**

Via A. Volta, 1  
24069 CENATE SOTTO (BG) - Italy

*Tel.:* +39 035 94 61 11 (8.30 – 12.30 / 14.00 – 18.00)

*Fax:* +39 035 94 52 22 (24 h)

*e-mail:* [gewiss@gewiss.com](mailto:gewiss@gewiss.com)

*sat:* [sat@gewiss.com](mailto:sat@gewiss.com)

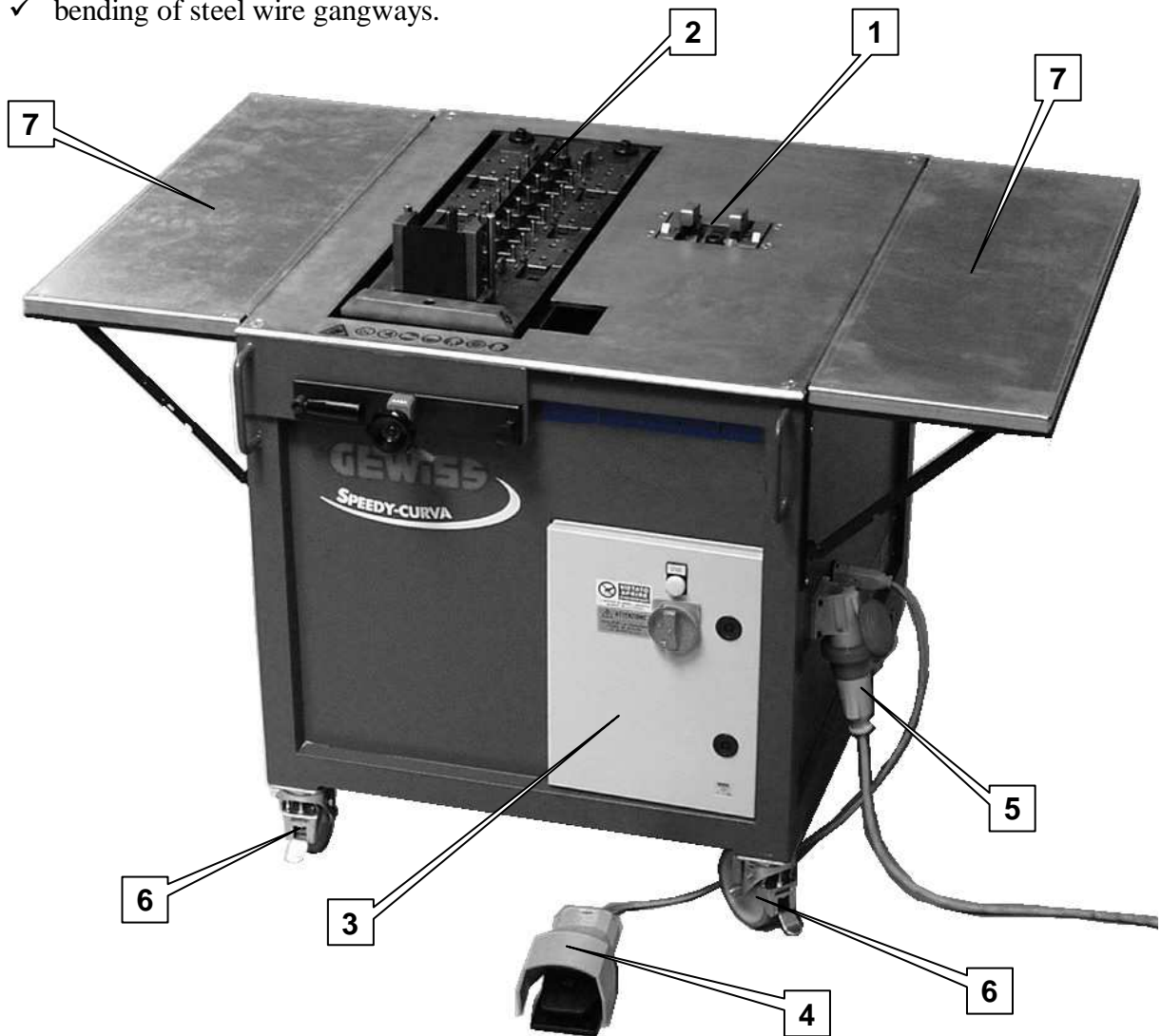
*web:* <http://www.gewiss.com>

When requesting technical support specify the type and serial number of the machine.

## ***2.1 General data and performances***

The machine can perform the following operations:

- ✓ cut of steel wire gangways;
- ✓ bending of steel wire gangways.





*Fig. 2.1 – Main parts of the machine*

- |                              |                           |
|------------------------------|---------------------------|
| <i>1. Cutting station</i>    | <i>2. Bending station</i> |
| <i>3. Control board</i>      | <i>4. Control pedal</i>   |
| <i>5. Power plug</i>         | <i>6. Wheels</i>          |
| <i>7. Collapsible tables</i> |                           |

## ***2.2 General information about safety***

### **2.2.1 Directions on residual risks.**

In order to avoid any dangerous situation for people or damage to equipment because of residual risks, such as those risks that persist in spite of all adopted instructions, or due to potential risks not evident, scrupulously keep to the following directions:

-  *Always comply with signals and directions on plates stuck to the machine, work only on the basis of instructions given in this manual, always keeping in mind the residual risks mentioned in Chapter 3 “Installation and connection”, Chapter 4 “Control Devices and working procedure” and Chapter 5 “Maintenance”.*
  
-  *Always comply with directions, even additional, prescribed at the working seat where You are operating (for example at yard).*

**2.2.2 Signals relating to potential risks and their displacement**

On the machine there are the following plates, signalling potential dangers, properly applied:

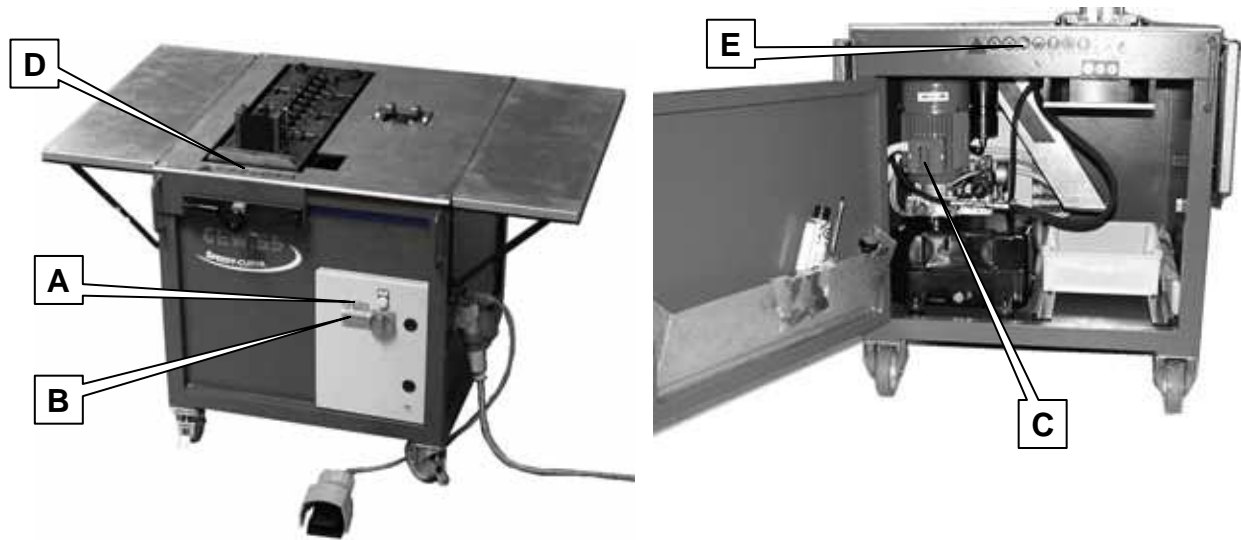


Fig. 2.2 – Displacement of signalling plates



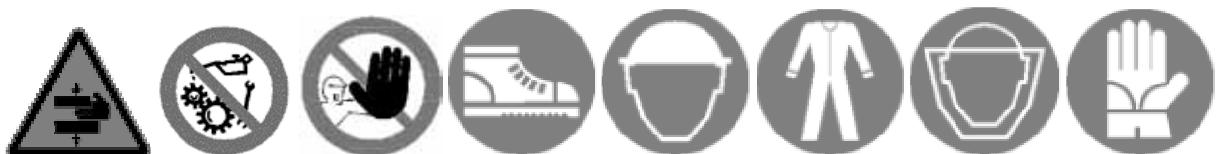
**Signal A:**

It shows the prohibition, for not authorised or not trained personnel, to have access inside the electrical control board. This plate is applied to the door of the main electrical board.



**Signals B and C:**

It shows to the attached, authorised and trained personnel, the presence of voltage even with open door. This plate is applied to the front of the door of the electrical board and inside near the terminals of electrical motor.



**Signals D and E:**

Multiple signals showing the danger of crushing arms, the prohibition to lubricate members in motion, the prohibition to use by not authorised personnel, the obligation to wear safety shoes, safety helmet, safety clothes, safety faceplate and safety gloves. This plate is applied on the worktable near the bending station and on the back upside the door.

### 2.2.3 Working area and operator's position

In order to keep a high standard of safety and avoid dangerous situations for people, as well as to allow the right use of the equipment, the area where it is required the presence of personnel, attached to the machine use is shown in fig. 2.4 with symbol **OP**.

Those areas carrying in the following figures the symbol **ZP** show the potentially dangerous zones, or rather those areas in which there are moving members or elements containing dangerous electrical voltage.

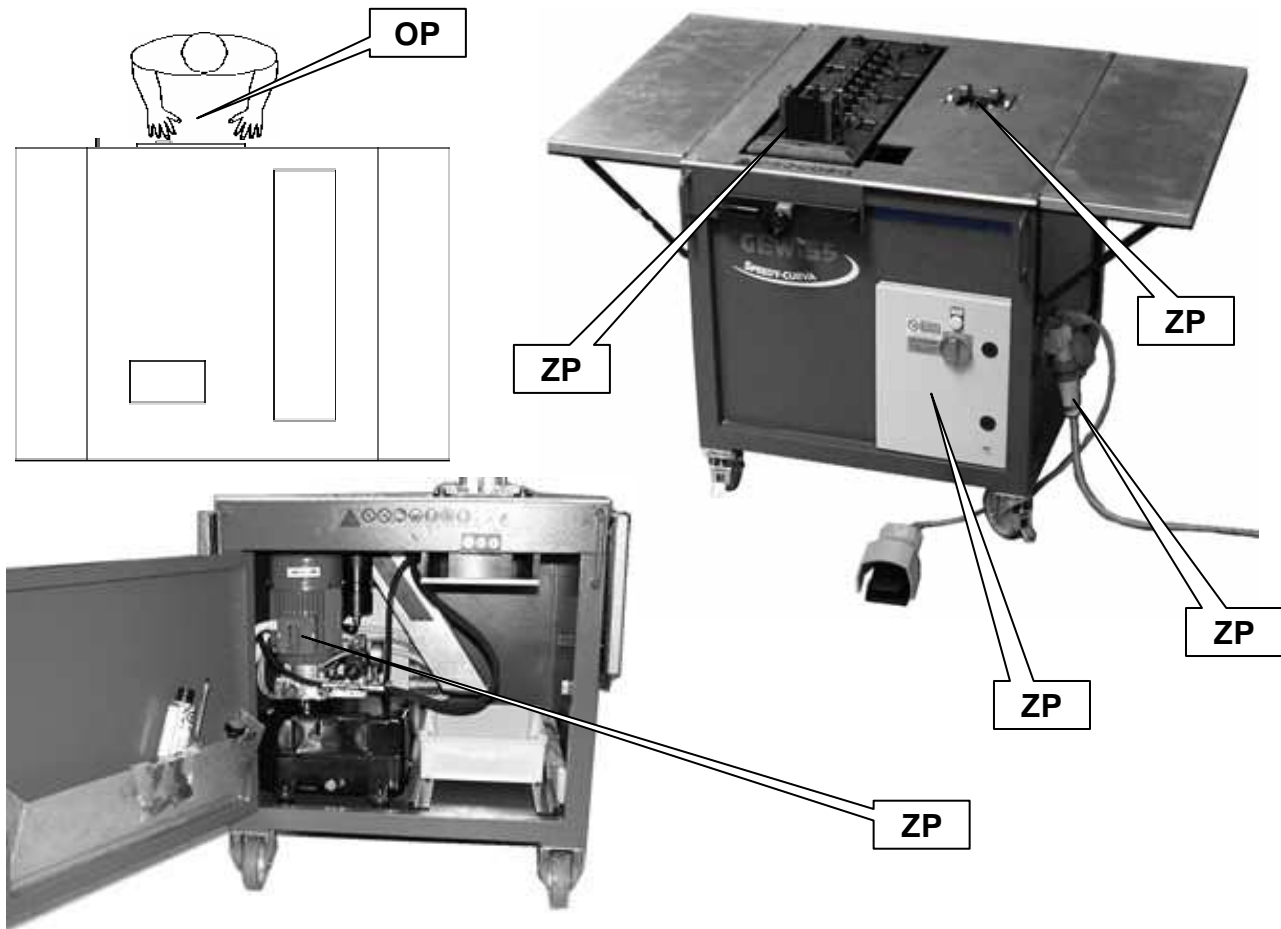


Fig. 2.3 – Working area and operator's position

- ☞ For ordinary machine operation and maintenance is required **only one** operator.
- ☞ During machine use, not authorised personnel must be sent away.
- ☞ Any direct operation on equipment different from ordinary work/supervision must be carried out by qualified technicians.

### 2.2.4 Directions on emitted noise

The machine is planned and manufactured so that the noise level is reduced to minimum during ordinary operation. The level of acoustic pressure pondered A, generated by different machine components and measured, according to standards set by regulations in force, at operator's work stations during running is < 80 db (A).

### 2.2.5 Proper and improper use

The machine can be used, by only one operator, **exclusively** for bending and cutting steel wire gangways manufactured by GEWISS. The catalogue codes of products to be worked with this machine are the following:

Range	Base product for finishing type				Height	Width
	Z100	EZ	GAG	INOX		
BFR 30		MV 50420	MV 50220		30	50
		MV 50421	MV 50221			100
		MV 50422	MV 50222			150
		MV 50423	MV 50223			200
		MV 50425	MV 50225			300
BFR 60	MV 50530	MV 50430	MV 50230		60	50
	MV 50531	MV 50431	MV 50231			100
	MV 50532	MV 50432	MV 50232			150
	MV 50533	MV 50433	MV 50233			200
	MV 50535	MV 50435	MV 50235			300
	MV 50536	MV 50436	MV 50236			400
	MV 50537	MV 50437	MV 50237			500
	MV 50538	MV 50438	MV 50238			600
BFR 110	MV 50542	MV 50442	MV 50242		110	150
	MV 50543	MV 50443	MV 50243			200
	MV 50545	MV 50445	MV 50245			300
	MV 50546	MV 50446	MV 50246			400
	MV 50547	MV 50447	MV 50247			500
BF 30				MV 50620	30	50
				MV 50621		100
				MV 50622		150
				MV 50623		200
				MV 50625		300

Range	Base product for finishing type				Height	Width
	Z100	EZ	GAG	INOX		
BF 56				MV 50630	56	50
				MV 50631		100
				MV 50632		150
				MV 50633		200
				MV 50635		300
				MV 50636		400
				MV 50637		500


In Annex 1 “*Bending parameters*” are shown the parameters to set on the machine in order to carry out, for any code above mentioned, 45° and 90° bends.

Product typologies to be realised are the following:

- Sharp quarter bend
- 90° Bend/angle
- Tee joint
- 100/200 mm necking
- Up and down-grade bends


The machine is planned and manufactured for working in areas where **there is no potentially explosive atmosphere** and in any case **sheltered from atmospheric agents** and **normally lit up**.

The machine use for different purposes and according to formalities not provided for by this manual, as well as bending and cutting of steel wire gangways not manufactured by GEWISS and not included in the above mentioned list may cause damages to people or equipment itself and are therefore considered **Improper and NOT SCHEDULED uses**. For them the responsibility does not rest on the Manufacturer.


 *In case of different use it is necessary to consult beforehand the Manufacturer’s technical offices..*

### 2.2.6 Directions and behaviour rules

In order to avoid any condition of risk for people or damage to the equipment, we suggest You to follow carefully all directions and behaviour rules here below mentioned.

 *The responsibility for any damage to things and/or people, resulting from the non-observance of these recommendations rests entirely with the attached personnel.*

- The operators assigned to the machine operation shall be properly trained in order to use the machine for the best and without any risk and shall operate in a comfortable place, that can guarantee their safety and sanitary conditions.

 *Do not let the equipment to be used by not authorised or not trained personnel.*

- The personnel assigned to the machine maintenance and/or adjustment has to know all procedures carried in this manual and has to be technically prepared for operating the machine properly and interpreting correctly both instructions and diagrams attached.
- In order to avoid damages to the machine and its components and/or cause dangerous situations, we recommend You not to lean objects on the machine working area/surface, not to lean yourself on it and not to try to climb it.
- Working personnel has to wear suitable clothes, avoiding or paying attention to:
  - fluttering clothes;
  - wide sleeves;
  - hanging down neck wear;
  - necklaces, bracelets and rings;
  - long hair (*if necessary, wear a cap or safety helmet*).

Consult the person in charge for the safety rules in force and the specific safety devices to be taken for personnel security.

- To operate machine with wet hands may represent a danger of discharge in case of breakdown or unexpected faults in earth connection. Remember to operate always with dry hands or use insulating gloves.
- Do not intervene inside the machine working area.
- Do not start damaged equipment.
- Before using the machine make sure that any condition dangerous for safety has been opportunely removed and the machine has been placed on a plane surface and fixed by brakes on front wheels.
- Notify people in charge that any operation irregularity has occurred.
- Make sure that all guards or other protections are on their place and that all safety devices are in perfect working order.
- The area where (*routine and extraordinary*) maintenance operations are carried out must always be clean and dry, and the equipment always available and in working order.





***IT IS FORBIDDEN any attempt to remove adopted safety measures or to evade them, in order not to reduce the machine safety level.***



***IT IS FORBIDDEN any kind of operation on hot machine. Always disconnect the electrical input system before operating on machine.***



*During maintenance or adjustment operations, especially when it is necessary to work with guards or safety devices off-line (for example an open electrical board), make sure that the working area is inaccessible by non authorised personnel.*

*At the end of any operation, make sure that no tools have been left inside the machine.*



***All materials with environmental impact that need to be eliminated as result of operations on machine (such as, for example, electric cables, oil, components, etc.) or rejections, have to be disposed according to regulations in force. If necessary, apply to organisations specialised in disposal.***

## 2.3 Technical specifications

### 2.3.1 Overall dimensions and position of the identification plate

In the following figure are carried the overall dimensions (*expressed in mm*) of machine.

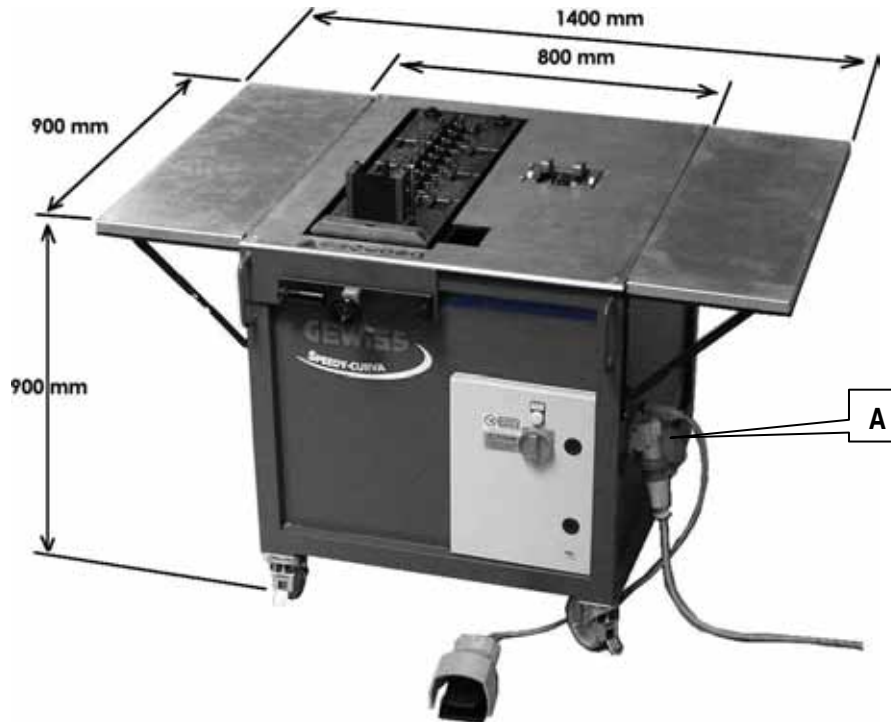
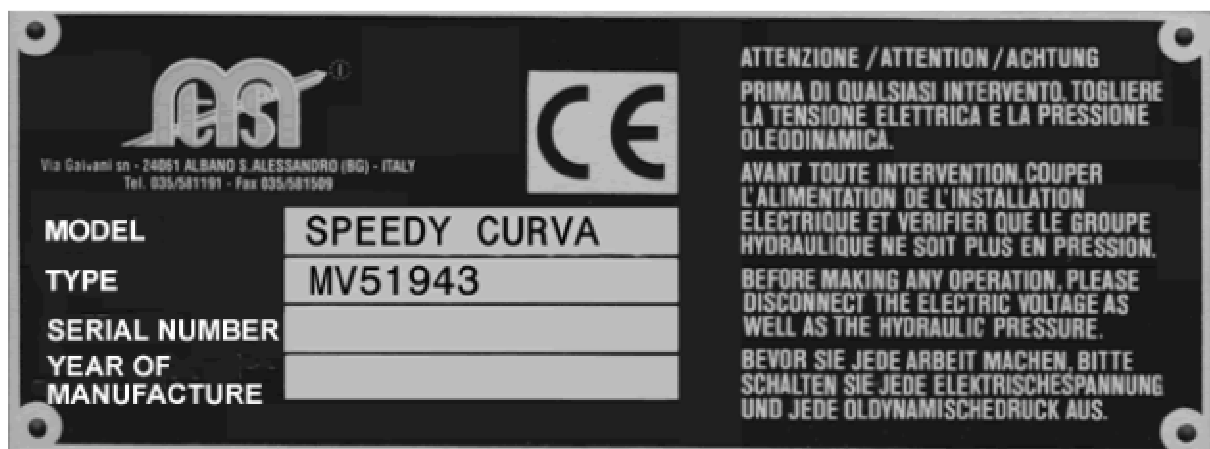


Fig. 2.4 – Overall dimensions

**A) Identification plate on the machine.**

Identification data written on the plate, applied on machine in position **A** (see Fig. 2.5), have to be mentioned at any request for operation or order of spare parts.



### 2.4 Technical data

#### 2.4.1 General specifications

<i>Dimensions</i>	See fig. 2.5
<i>Overall weight</i>	about 350 Kg
<i>Typology of gangways</i>	(see Paragraph “Proper and improper use” in this Chapter)

#### 2.4.2 Performances

<i>Rate of production</i>	variable depending on dimensions, worked materials, speeds made possible by adopted devices considering the use by only one operator
<i>Life of cutting blades</i>	min. 50.000 blows with BFR wire (N.B.: 20% less with INOX BF wire)
<i>Life of mechanical, electric, hydraulic components</i>	min. 500.000 cycles

#### 2.4.3 Electric system

<i>Input voltage</i>	400 V 3P + T 16 A
<i>Input frequency</i>	50 Hz ( $\pm 5$ Hz)
<i>Total absorption</i>	1,1 kW
<i>Connecting plug</i>	fixed, wall-type, at 90°, proof

#### 2.4.4 Hydraulic box

<i>Hydraulic oil type</i>	H-LP 46
---------------------------	---------

#### 2.4.5 Standard equipment

##### *Components*

- Use and maintenance manual (this document)
- 1 Fulcra R and L (in the inside opening of machine)
- 2 Fulcra 3, 4 and 5 (two per type set on bending station)
- 3 Box for scraps (in the inside opening of machine)
- 4 Control pedal (in the inside opening of machine)

**Tools**

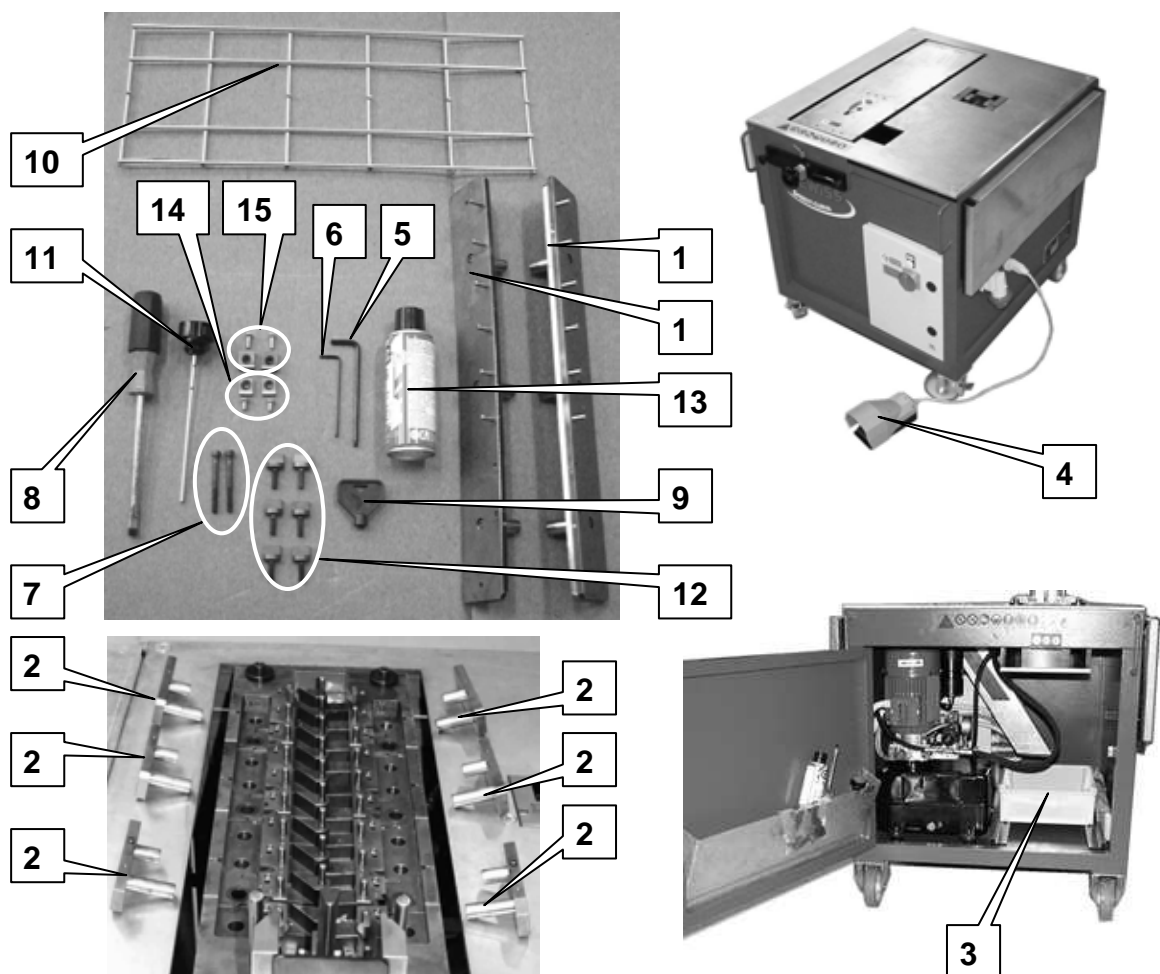
- **5** A 5 mm setscrew wrench (in the rear door pocket)
- **6** A 3 mm setscrew wrench (in the rear door pocket)
- **7** Two M6 screws for fulcra drawing (in the rear door pocket)
- **8** A screw driver (in the rear door pocket)
- **9** A wrench for opening the control board (in the rear door pocket)

**Fittings**

- **10** wire net guard (set in the bending station)
- **11** Hydraulic box drain plug (in the rear door pocket)
- **12** 6 knobs for wire sealing (4 of them set in the bending station and two spare in the rear door pocket)
- **13** An aerosol oil bomb (in the rear door pocket)

**Spare parts**

- **14** Two upper blades complete with screws (in the rear door pocket)
- **15** Two lower blades complete with screws (in the rear door pocket)



*Fig. 2.5 – Standard equipment*

### ***3.1 Residual risks during lifting and transport***

#### **Present risks:**

- ✓ Risks due to crushing of the operators attached to the handling;
- ✓ Risks due to lacking of load stability during examined operations;
- ✓ Risks due to crashes of the machine after wrong behaviours.

#### **Scheduled PPD:**

- ✓ Overalls, safety helmet, safety gloves and injury shoes.



#### **During lifting and transport mainly pay attention to the following operations:**

- ✓ Check that all the movable elements of the machine are fastened according to the manufacturer instructions;
- ✓ Check that on the Hydraulic Box is replaced the vent plug by the plug without vent supplied by the manufacturer;
- ✓ Follow normal cautions relative to the usage of hoists and bridge cranes;
- ✓ During the slinging operations follow the normal cautions to avoid crashes, tiltings and unforeseen movements of the machine, considering that the structure is not symmetrical;
- ✓ The machine and its equipment must be protected from the external atmospheric agents; particularly, the water and the humidity can oxidize some elements of the machine, damaging them irreversibly

## ***3.2 Residual risks during positioning and connection***

### **Present risks:**

- ✓ Risks due to obstacle or fall connected with power connections;
- ✓ Risks due to the electric energy presence.

### **Scheduled PPD:**

- ✓ Overalls and safety gloves.



### **Signals:**

- ✓ Connected with the electrical cabinet there are special danger and prohibition signals.


### **On positioning and connection pay attention mainly to the following operations:**

- ✓ Choose a suitable place for the installation as per availability of power supply;
- ✓ Protect the electric power cables with stiff sheaths or suitable cables duct;
- ✓ Foresee a sufficient space for the normal use and maintenance of the machine, including the space for possible peripheral equipping and limiting the machine perimeter;
- ✓ Check that the installation of the electric system is in compliance with the power supply specifications of the machine, especially if operating in yard.

## ***3.3 Introduction***

Being a machine movable by wheels, the installation (or possible reinstallations) of the machine is directly performed by the qualified operator.

Before proceeding to the installation of the machine, it is however necessary to arrange the connection to the electric system necessary for the right working of the machine, following the indications carried out in this chapter.

 *The responsibility of any damages to things and/or people deriving from improper operations performed by unqualified or unauthorised personnel clearly rests on such personnel.*

### ***3.4 Installation Seat***

The intrinsic stoutness of the machine allows its use in almost all conditions of onerous and continued work, as well as in moderately dusty environments.



*The machine itself does not emit gas, steams or dusts. If it is installed in excessively dusty environments, it may be damaged but it may not create danger situations.*

*The machine must be utilised sheltered from atmospheric agents (rain, hail, etc.) and in normally lit rooms.*

*The machine must be installed in dry and without humidity rooms.*

*The machine must be moved, by wheels, only along flat surfaces and with its supporting surfaces closed. If it is necessary to proceed along slopes it needs to proceed to its handling by a lift truck.*

*Besides, it must NOT be installed and used in areas with explosion risks.*

*If it is installed in environments subject to agents corrosive for the installed organs, it is necessary to change the breaks among functioning and maintenance checks, adapting them to the existing work conditions in order to avoid a wear in advance of said organs.*

The scheduled seat of installation must be in compliance with the following specifications:

- ✓ The ambient temperature must be between 10° and 40 °C, with relative humidity lower than 90% (*not condensing*).
- ✓ The chosen place must favour a suitable operation during installation, setting at work and support. To operate in safety, it is usually sufficient normal lighting. On the contrary, it is necessary to install one or more light sources suitably displaced.
- ✓ The floor on which the machine will be placed must be levelled to guarantee the right clamping of the machine by the scheduled mechanical blocks on the front wheels.

### ***3.5 Unpacking, lifting and transport***




The machine is delivered:

- on wooden pallet wrapped by thermoretractable material (fig. 3.1);
- with full tank of the Hydraulic box.



*Fig. 3.1 –Packed machine*

The machine can be transported towards the installation seat by an hoist, a bridge crane or a lift truck suitable for the dimensions and the weight of the same one.

 *If the machine must be stored to be used afterwards, do not take away the thermo retractable material that covers it to protect all its parts during the storage.*

#### **Procedure:**

- Eliminate, by a cutter ,the thermo-retractable material covering the machine.
- Sling the machine, using slings and equipments suitable for the weight of the machine, hooking the slings to the handles on the sides of the machine (fig. 3.2).



*1. Handles*

*Fig. 3.2 –Handles*





*We recommend you to pay maximum attention during the removal of the thermo retractable material and of the pallet in order to avoid damages to people and/or to the machine. Dispose the packing material as per regulations in force on disposal.*

*Do not lift the machine catching it by its not structural elements as cables, sheathes, etc.*

*Make sure that no objects lean on the machine and can fall during handling.*

*Tie together the supporting surfaces to the machine itself to prevent movement.*

*The whole operation must be carried out by skilled personnel and coordinated by the responsible of the installation who will make sure that all necessary safety measures are adopted to avoid the possibility of risks to people and damages to the machine.*

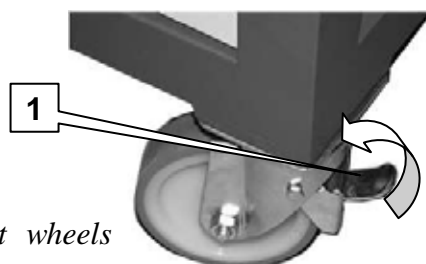


*The responsibility of possible damages to things and/or people deriving from the non-observance of the recommendations carried out clearly rests on the attached staff.*



*Check that the machine has not suffered damages during transport. Notify immediately to the Technical Support possible damages, defaults or found differences.*

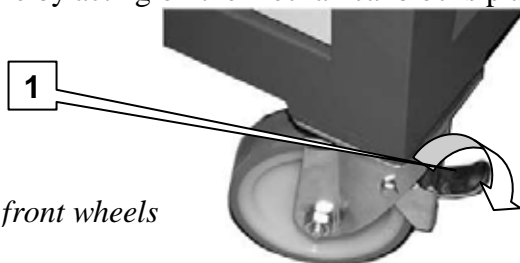
- Lift the machine by 10 cm to take out the pallet on which it leans.
- Lay the machine slowly on the floor.
- Unlock the mechanical blocks placed on the front wheels (fig. 3.3).



*1. Blocks on the front wheels*

*Fig. 3.3 –Blocks on the front wheels*

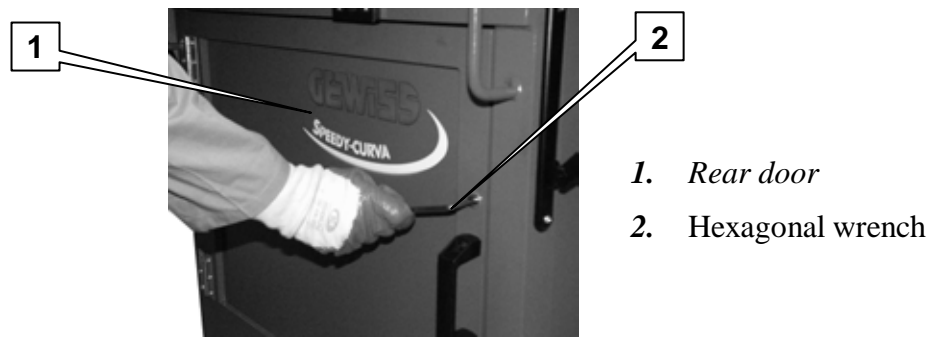
- Take the machine to the chosen seat of installation.
- Lock the machine by acting on the mechanical blocks placed on the front wheels (fig. 3.4).



*1. Blocks on the front wheels*

*Fig. 3.4 –Blocks on the front wheels*

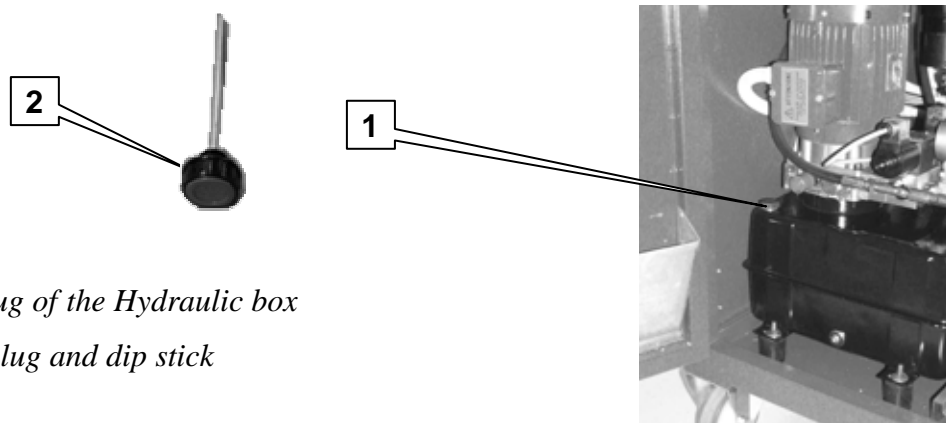
*Open the rear door by hexagonal wrench (fig. 3.5).*



1. Rear door
2. Hexagonal wrench

Fig. 3.5 – Rear view of the machine

Replace the oil plug of the hydraulic box with the vent plug and dip stick supplied (fig. 3.6).



1. Oil plug of the Hydraulic box
2. Vent plug and dip stick

Fig. 3.6 – Oil plug of the Hydraulic box

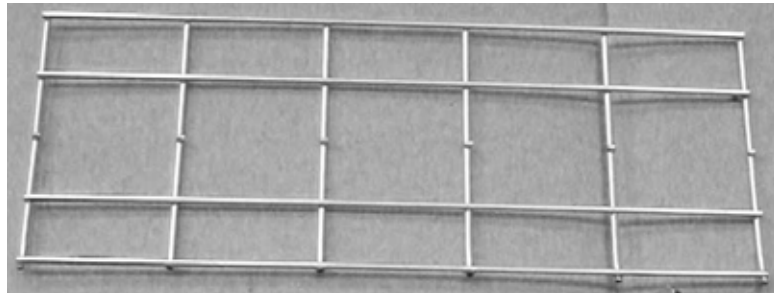
- Lift the bending station following the “Positioning” procedure carried out in paragraph 4.3.3.3 “Arrangement of the bending station”
- Disassemble the wire net guard fixed on the bending station (fig. 3.7) and place it inside of the machine under the box for scraps.



1. Wire net guard

Fig. 3.7 – Wire net guard

- ☞ In case of loss of the wire net guard it is possible to construct it by cutting properly a gangway wide at least 300 mm (fig. 3.8).



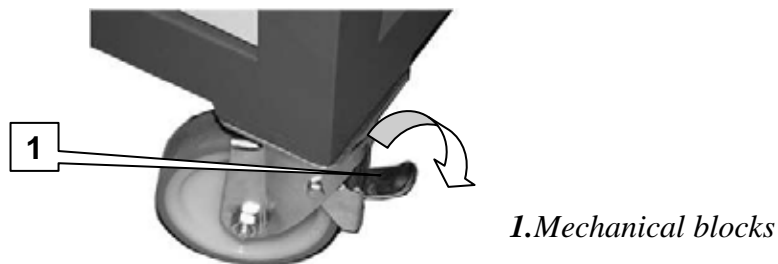
*Fig. 3.8 – Wire net guard*

- ☞ The following transports must be performed restoring the machine conditions as on delivery. It may be avoided packing the machine by thermo retractable material but it is necessary to tie the supporting surfaces to the machine itself preventing its movement.
- ☞ Following movements can be performed exploiting the machine wheels (see also Paragraph 3.4 “*Installation seat*” in this Chapter).

## **3.6 Positioning**

### **3.6.1 Fastening**

When the machine has been transported/moved to the scheduled installation seat it is necessary to fasten it by the mechanical blocks placed on the front wheels (fig. 3.9).



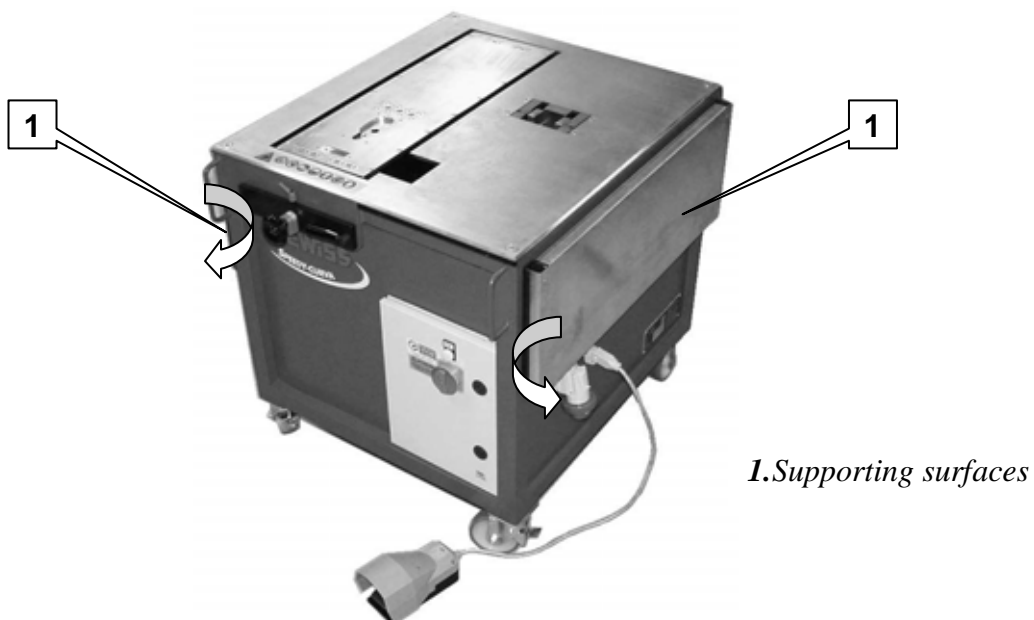
*Fig. 3.9 – Machine positioning*

### **3.6.2 Opening and Closing of the collapsible faces**

If very long gangways are to be worked we recommend you to open the collapsible faces and eventually to put laterally also some stands (not on issue).

**To open the collapsible faces proceed as follows:**

- Lift the supporting surface (fig. 3.10).



*Fig. 3.10 – Front view*

- Fasten the supporting surface in position by pushing alternately downwards the two side arms and locking them in position (fig. 3.11).



*Fig. 3.11 – Supporting surfaces fastening system*

**To close the collapsible faces proceed in the opposite way to the previous description.**

### 3.7 Link and connection

To perform a right arrangement at the installation of the machine it is necessary:

- to arrange the electric system line in order to reach the chosen connecting point, stated in fig. 3.12;
- to connect the control pedal as stated in fig. 3.12.

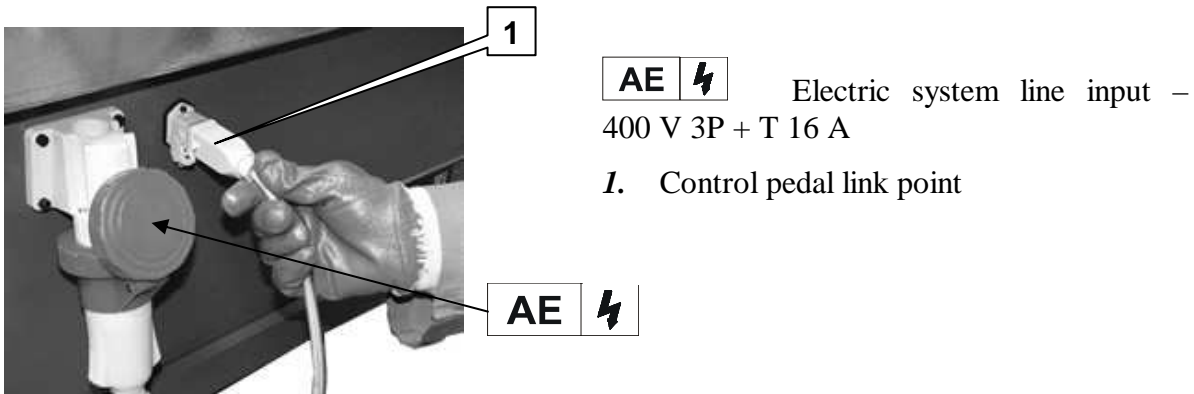



Fig. 3.12 –Link and connection points



#### 3.7.1 Electric system link


The system is equipped with a power plug of industrial type adequately dimensioned with ground pole to guarantee the full grounding of the machine. For the electric system is sufficient then to arrange an electric outlet able to deliver electric energy at specified voltage and frequency and suitable to the absorbed power of the system (see section “Technical data” in Chapter 2).

 *The electric equipping installed on the equipment is foreseen to work rightly with the specified voltage and amperage.*

Keep also to the following warnings:

- ✓ If the installed power plug and outlet are incompatible, let the outlet be replaced with another of suitable type by qualified personnel. Usually, it is not advisable to utilise adapters, multiple outlets and/or extensions.
- ✓ It is advisable to install a suitable disconnecting switch with relative electric protections above the power supply link point of the equipment, in order to isolate the last one without unplugging the power plug.
- ✓ Make sure that the amperage of the current meter is suitable for the absorption system.
- ✓ The electric system connected to the equipment in subject must be realised in accordance with the regulations in force and must be suitably grounded to avoid the possibility of electric shock or damages to the equipment.

- ✓ Never touch the equipment with wet or damp feet nor use it barefoot.
- ✓ Do not pull out the power cable to disconnect the power plug from the outlet.
- ✓ Make sure that the power cable doesn't bend, is not exposed to high voltages and is not crushed or pinched.

 *The responsibility of possible damages to things and/or people deriving from the non-observance of the recommendations carried out rests clearly on the attached staff..*

### 3.7.2 Control pedal connection

The control pedal is inside the machine frame.



To connect the control pedal to the machine it is necessary to follow this procedure (fig. 3.13):

1. Open the rear panel of the machine;
2. Extract the control pedal and the relevant connection cable;
3. Locate the control pedal in connection with the control station;
4. Connect the cable of the control pedal to the machine.

1. Rear panel
2. Control panel position
3. Control pedal connection cable
4. Control pedal connection point to the machine

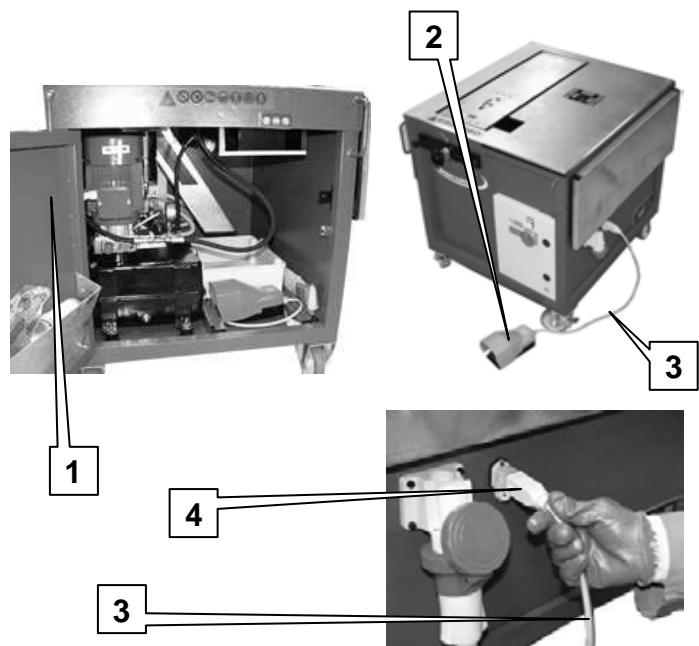


Fig. 3.13 – Control pedal connection to the machine

### **3.8 Storage**

If it is necessary to store the machine for a long time, we recommend you to protect it adequately and to store it in a suitable room (*with temperature between 5°C and 50 °C and relative humidity lower than 90% - not condensing*) and sheltered from atmospheric agents in order to avoid its deterioration restoring the machine conditions as it was on delivery as stated in Paragraph 3.5 “Unpacking, lifting and transport” of this Chapter.



***When the machine is not in use and before each storage of the machine itself protect the metallic parts with a preservative substance to prevent the rust formation.***



***If such necessity occurs on delivery of the machine, we recommend, in these cases, not to remove from the equipment the packing and/or to take suitable precautions to protect the displayed parts.***



### **3.9 First setting at work**

At the end of installation and connection, proceed to a careful cleaning of the whole machine, removing, by exhaustor, dust and residuals especially at the bending station and cutting station. Clean the control panel, with a soft cloth, eventually drenched of neutral detergent.



***NEVER use gasoline, solvents or others inflammable liquids to clean the machine.***



***The equipment, before delivery, is tested and set up by expert and qualified staff, in order to guarantee its right functioning. In case defaults and/or malfunctioning occur, do not use the equipment but disconnect it from sources of power supply and notify the Technical Support.***

Check, during the first starting, that all connections are carefully performed and the power voltage complies with prearranged limits.



***Before starting the machine, we recommend You to check the full working order of all devices connected with safety (disconnecting device, etc.).***

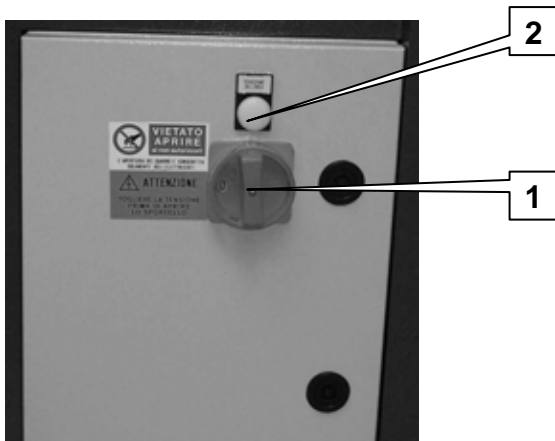




### 3.9.1 Motor sense of rotation check

**Procedure:**

- Turn to position **I** the disconnecting switch placed on the Control panel and check that the white pilot light indicating voltage presence is ON (fig. 3.14).



1. Disconnecting switch
2. White pilot light indicating voltage presence.

*Fig. 3.14 – Control panel*

- Check that the bending station is faced downward as stated in fig. 3.15.



*Fig. 3.15 – Work station selection*

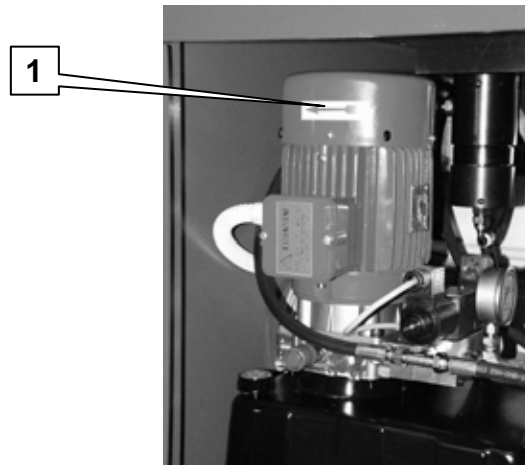
- Open the rear door with the hexagonal wrench (fig. 3.16).



1. Rear door
2. Hexagonal wrench

Fig. 3.16 –Rear view

- Check that the motor turns as the arrow sense indicates (fig. 3.17).



1. Arrow, placed on the motor, indicating the rotation direction

Fig. 3.17 – Rear view

- ☞ If the motor rotation is opposite to the one indicated by the arrow, it is necessary to invert 2 cables (phases) of the power plug.

## ***4.1 Residual risks during setting at work and use***

### Present risks:

- ✓ risks due to crushing connected with bending and cutting stations.

### Scheduled PPD:

- ✓ overalls, safety gloves, safety faceplate.



### During the machine setting at work and use mainly pay attention to the following operations:

- ✓ do not insert arms inside movable elements of machine;
- ✓ push the control pedal only if there are no other operators working near dangerous areas.

## ***4.2 Control and signal devices***

Here below are described all the machine control devices.

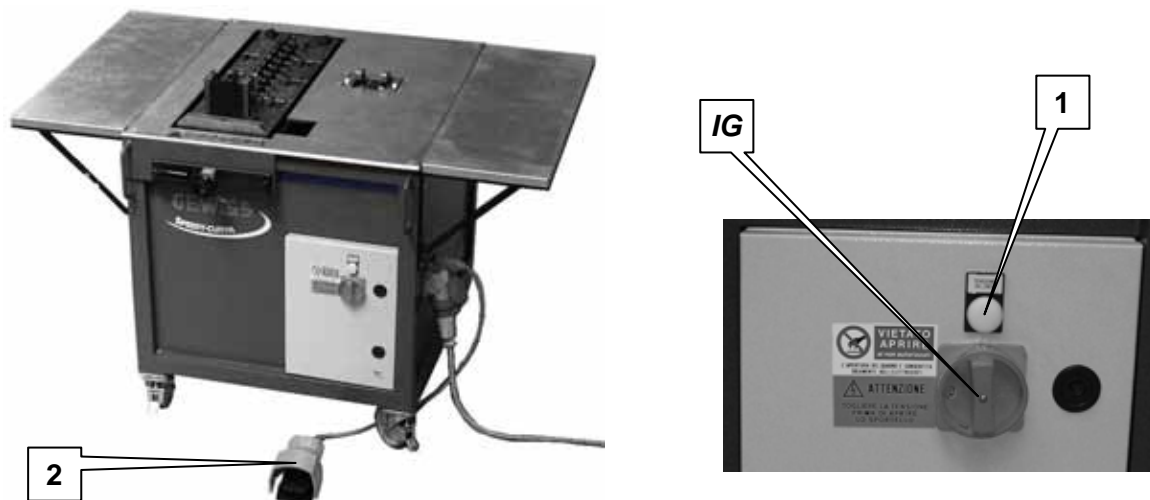
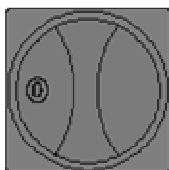


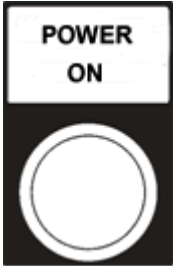
Fig. 4.1 – Control and signal devices



### **IG) General breaker/disconnecting switch**

It is a disconnecting switch for powering (*pos. ON – 1*) or not (*pos. OFF – 0*) the equipment. It works also as a “door lock”, preventing access inside the electrical control panel when voltage is on.

In case of special operations (*maintenance, adjustment, etc.*) this switch can be locked at position **OFF – 0** by means of a padlock or other suitable device.



1) **Pilot lamp for signalling voltage**

When the machine is powered (*switch **IG** on position **ON – 1***), the **WHITE** pilot lamp lighted means that electrical power is on.

2) **Control pedal**

By pushing the pedal the machine starts the bending cycle if the bending station is turned upwards, if it is turned towards the inside of machine (see fig. 4.17) starts the cutting cycle. By releasing the pedal the machine stops.

## 4.3 Working procedure



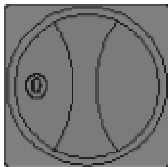
### 4.3.1 Machine starting

In order to power machine work as follows:

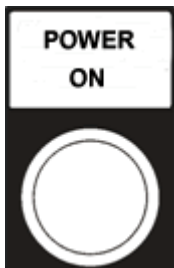


*Check if the machine power plug is in and the relevant outlet is powered.*

*Check if there are no foreign bodies connected with the bending station and the cutting station.*



Switch the general breaker placed on the main electrical control box (*part. **IG** fig. 4.1*) on position **1 – ON**.



Check that the pilot lamp, signalling voltage, is on (*part. **I** fig. 4.1*).



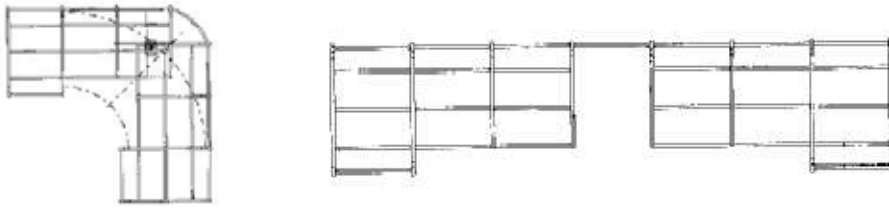
### 4.3.2 Cutting operation



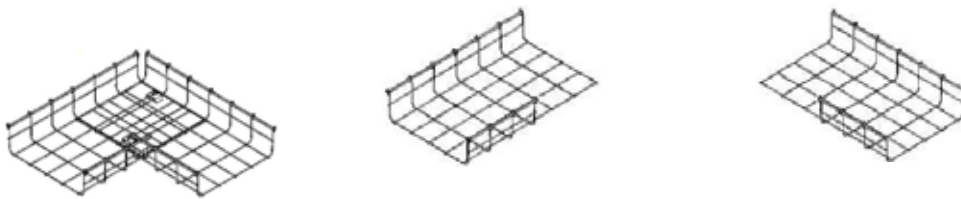
*This cutting mode makes possible to cut wires without burrs and it reduces, consequently, accidents during handling. The parts of cut wire are collected in a box placed inside the machine bed.*



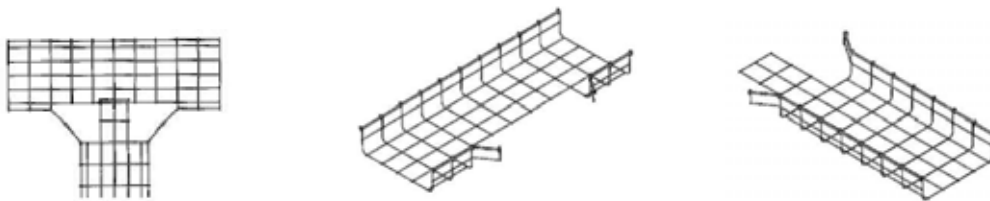
*By this cutting station it is possible to carry out top/tail cuts **preparing** the gangway for all machinings mentioned in **GEWISS EUROPASS** catalogue (see figg. 4.2, 4.3, 4.4, 4.5 and 4.6) that need, except for plane bends, the subsequent use of screw joints, clamps and connections for final laying.*



*Fig. 4.2 – Sharp quarter bend*



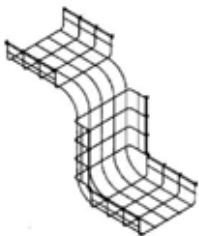
*Fig. 4.3 – Bend/angle 90°*



*Fig. 4.4 – Tee joint*



*Fig. 4.5 – Necking*

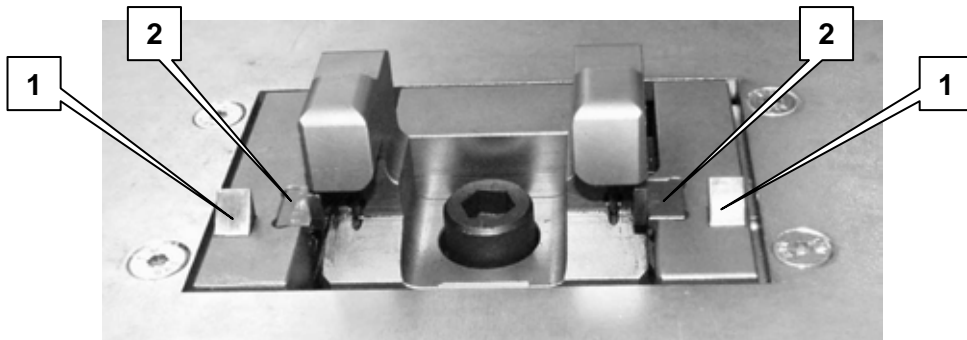


*Fig. 4.6 – Up and downgrade bends*

**4.3.2.1 Possible cuts**

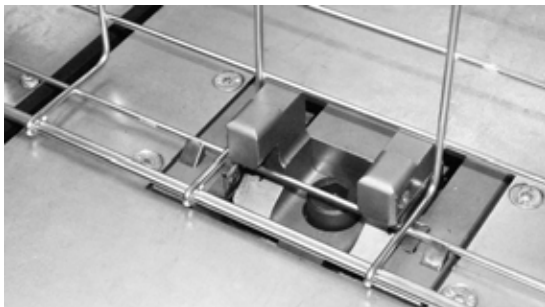


For any type of cut always try to position wire beyond lock **1** and keep wires parallel to blades as much as possible **2**.

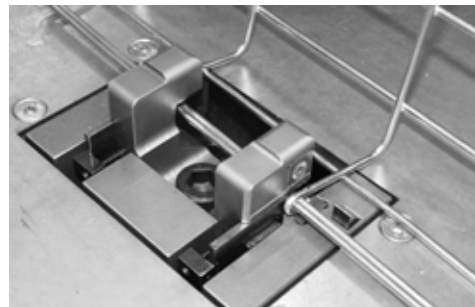


*Fig. 4.7 – Locks and blades*

**Side double cut**



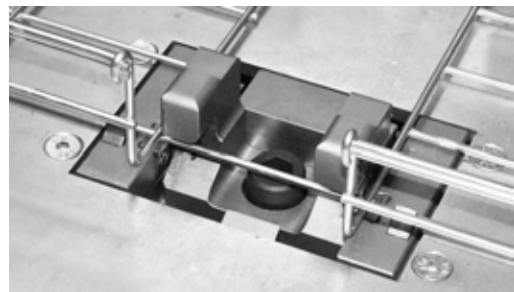
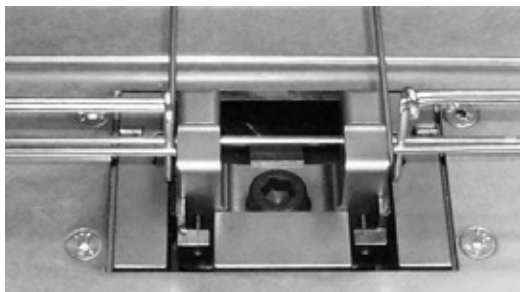
**Front**



**Rear**

*Fig. 4.8 – Side double cut*

**Base double cut**



*Fig. 4.9 – Base double cut*

## Single cut on side transversal wire

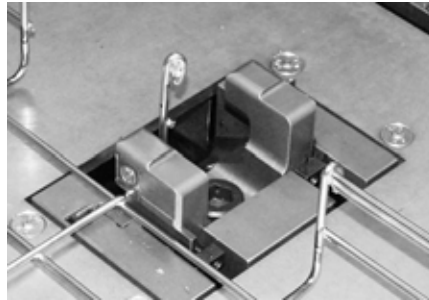
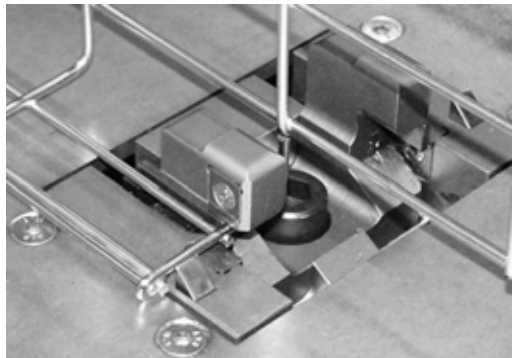
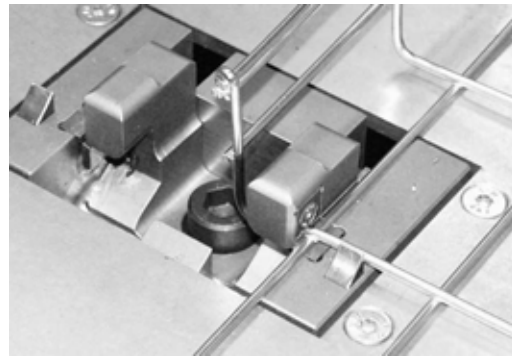


Fig. 4.10 – Single cut on side transversal wire

## Single cut on bent part of side transversal wire



External



Internal

Fig. 4.11 – Single cut on bent part of side transversal wire

## Single cut on part of straight wire 50 mm long

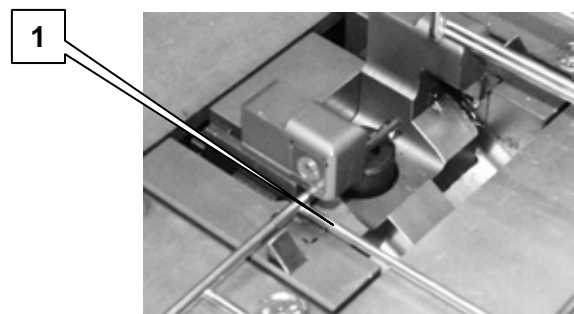
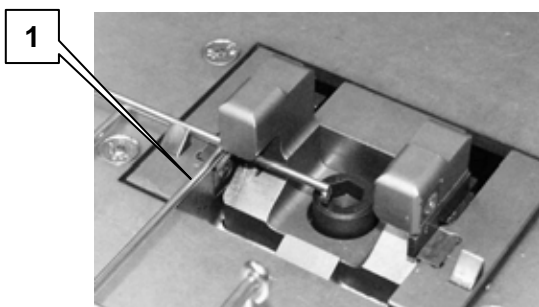


Fig. 4.12 – Single cut on part of straight wire 50 mm long



Before cutting check that wire **1** is on the left of the blade.



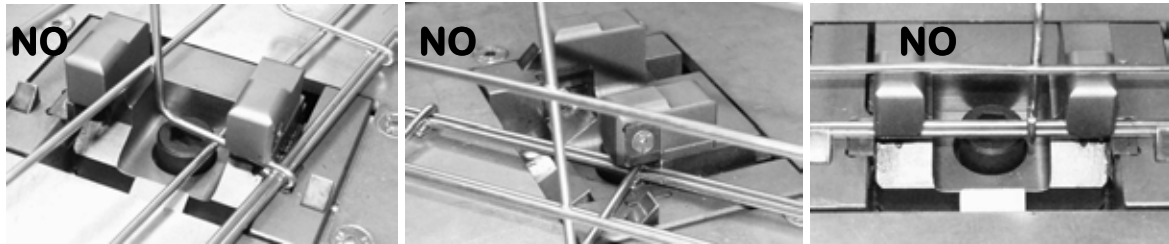
For carrying out all single cuts pay your best attention to wire positioning under shear.



**4.3.2.2 Important notes on cutting operation**

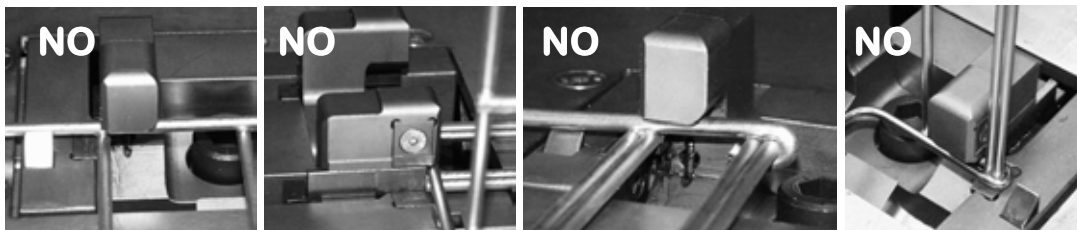
- ☞ *The responsibility for any damages to things and/or people resulting from improper operations carried out by non-skilled or non-authorized personnel rests only on such personnel.*
- ☞ *Cuts different from those considered possible are not allowed.*

**Cuts not allowed**



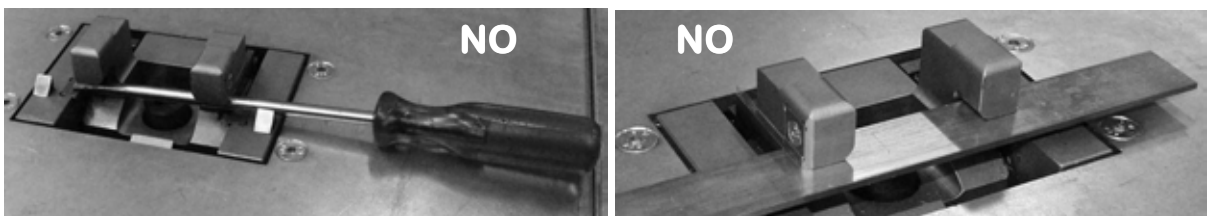
*Fig. 4.13 – Cuts not allowed*

- ☞ *Avoid feeding wires slantwise and double ones vertically*



*Fig. 4.14 – Cuts not allowed*

- ☞ *Absolutely avoid longitudinal cut of wires.*
- ☞ *Make sure that section to be cut is completely covered up with blades. Cuts with lowered locks are not allowed.*

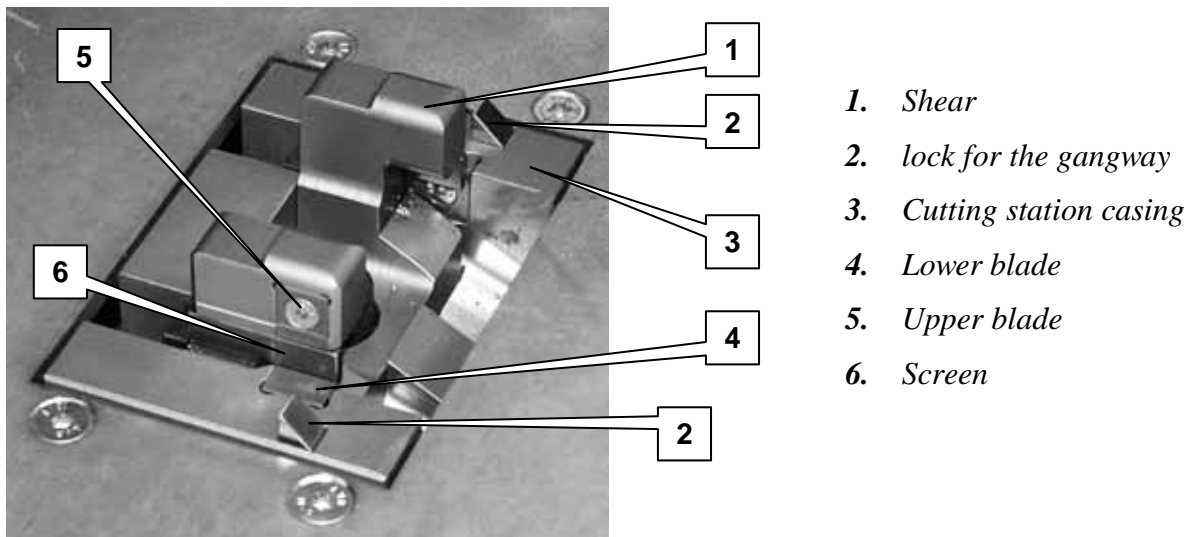


*Fig. 4.15 – Cuts not allowed*

- ☞ *Do not carry out cuts of parts which are not wires of GEWISS gangways and comply with suggested cutting modes. You may cause serious damages to the cutting station and it could be dangerous for the operator.*

- ☞ *Before starting cutting operations check if there is a box for scraps and its residual capacity. If it is full see Paragraph 4.3.2.12 “Emptying box for scraps”.*
- ☞ *In case of long gangways cutting open the side collapsible tables in order to widen supporting surface for the gangway. If necessary it is possible to place stands sideways.*
- ☞ *If a wire doesn't fall into the evacuation duct or it leans against the shear ( **1** in fig. 4.16) switch off the machine, insert it in the duct and, if it is too big to pass through, put it in the box for scraps.*
- ☞ *Do not carry out cutting operations on bent gangways.*
- ☞ *Never work with hands and/or tools at the cutting station if the machine is switched on.*

**4.3.2.3 Description of the cutting station and description of the cutting cycle**



*Fig. 4.16 – Cutting station*

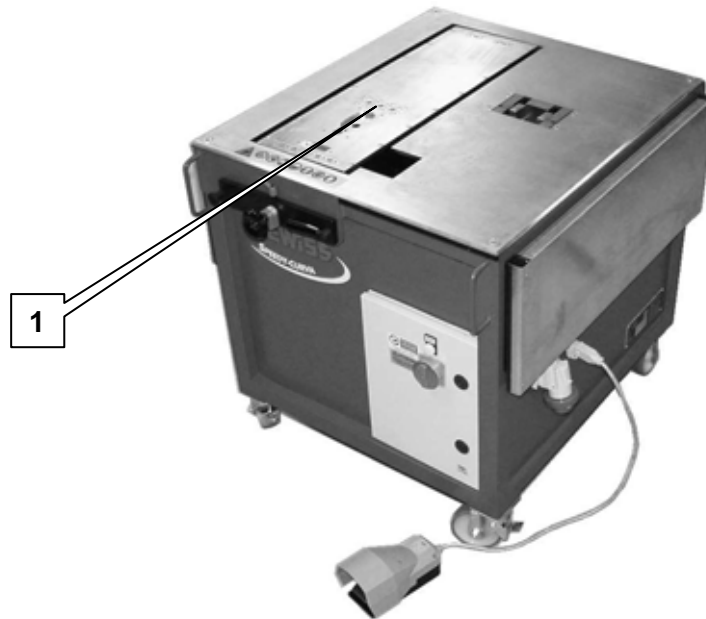
**Description of the cycle**

Any time you press on the pedal you carry out the movement opposed to the previous one: if in the last movement the upper body is going down, during the following movement it will go up and viceversa.

If, for any reason, an undesired movement occurs it is possible to select the wanted one by pressing on the pedal for a few seconds. In this way the station has not time enough to move and at the following start the station will operate as you desire.

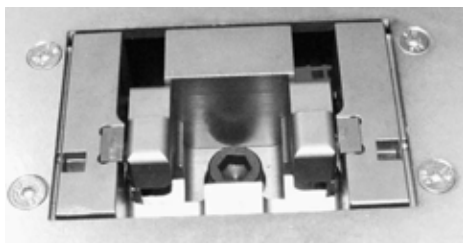
**4.3.2.4 Arrangement of cutting station**

1. Check that the bending station **I** (fig. 4.17) is turned towards the inside of the machine. Otherwise, follow directions at points 3 and 6 of procedure in Paragraph 4.3.3.6 “*End of bending operation*” of this Chapter;
2. switch on the machine as in Paragraph 4.3.1 “*Machine switching on*” of this Chapter;

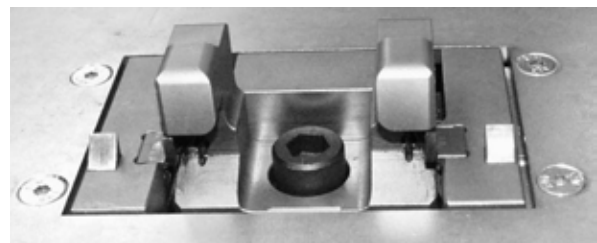


*Fig. 4.17 – Bending station turned towards the inside of machine*

3. press, with your foot, the control pedal and keep it pressed until the shear is completely lifted up. If it does not go up, reverse the cycle of the movement by releasing and then pressing again the pedal;



**Completely down**



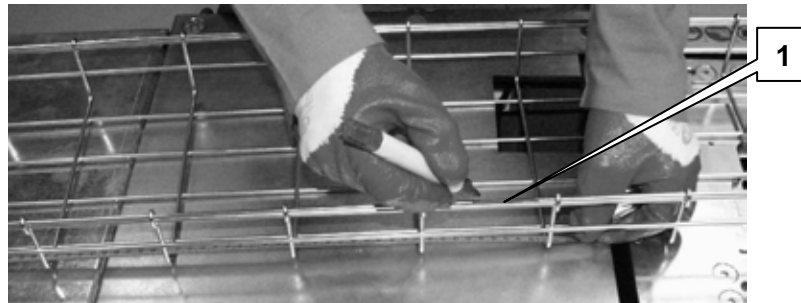
**Completely up**

*Fig. 4.18 – Shear lifting*

**4.3.2.5 Top/tail cut**

This kind of cut is used to make a cut down size of gangway shorter than 3 m. All wires relating to the sector to be cut are removed.

1. Define the measure of the cut down size of gangway to carry out. If the cut down size is to be used for making a curve, you can find the minimum length to cut in tables of Annex I “Parameters for bending”;
2. define sector **1** (fig. 4.19) to be cut, measure with a ruler or count the number of sectors (one sector is equal to 100 mm);



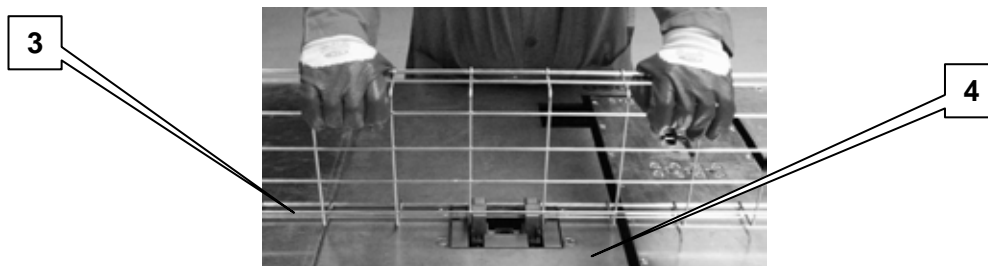
*Fig. 4.19 – Sector identification*

3. insert the first lateral wire **2** (fig. 4.20) of front side (it is the side nearest to operator),



*Fig. 4.20 – Insertion of the first wire*

4. keep the gangway **3** pressed on the worktable **4** by pressing with your hands on both sides (fig. 4.21);



*Fig. 4.21 – Gangway positioning*

5. check that the wires are in the right position
6. press, with your foot, the control pedal and keep it pressed until cutting operation is completed (side double cut);
7. press, with your foot, the control pedal and keep it pressed until the shear is completely lifted up **5** (fig. 4.22);

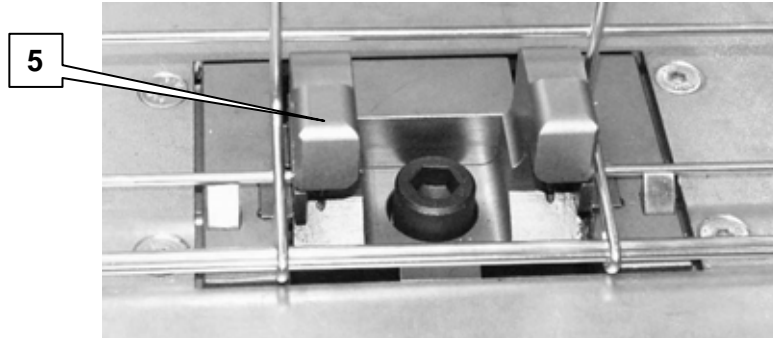


Fig. 4.22 – Shear lifting

8. insert and cut the next lateral wire of the front side **6** by pushing forward the gangway **7** (fig. 4.23); if the side is made with only one wire see the next point;

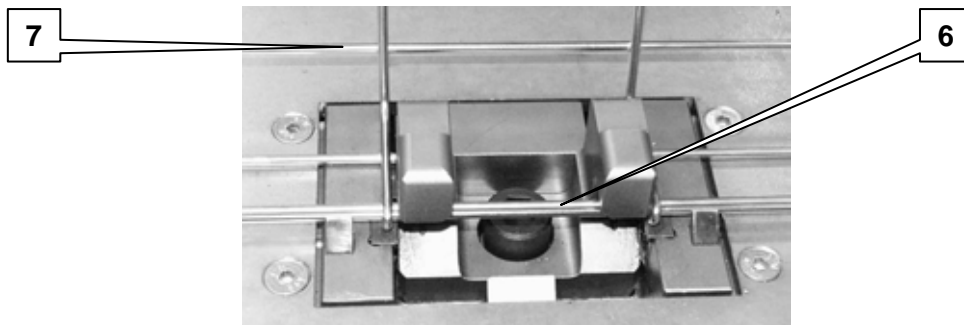


Fig. 4.23 – Next cut

9. carry out the cut of wires in the rear side **8** (fig. 4.24) (the farther side from operator) as per points 3 ÷ 8 of this procedure;

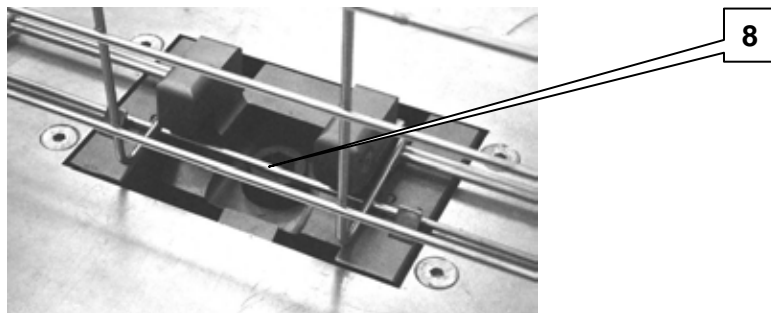
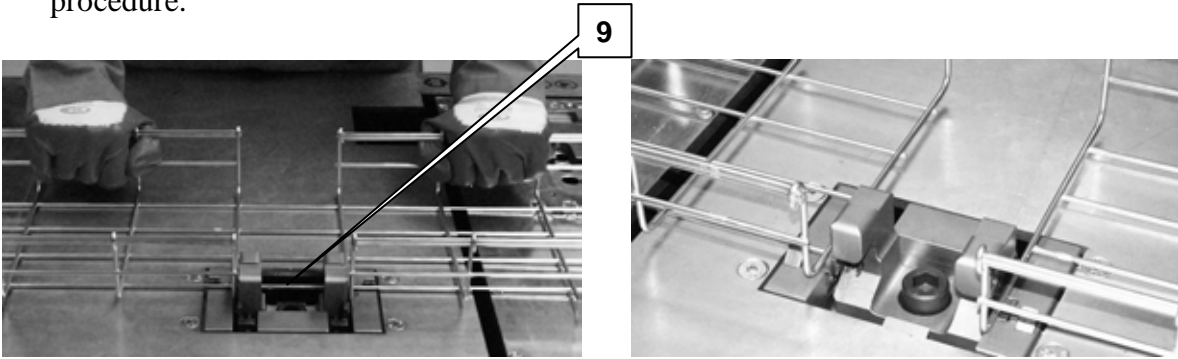


Fig. 4.24 – Cut of rear side

10. carry out the cut of base wires **9** (fig. 4.25) (base double cut) as per points 3 ÷ 8 of this procedure.



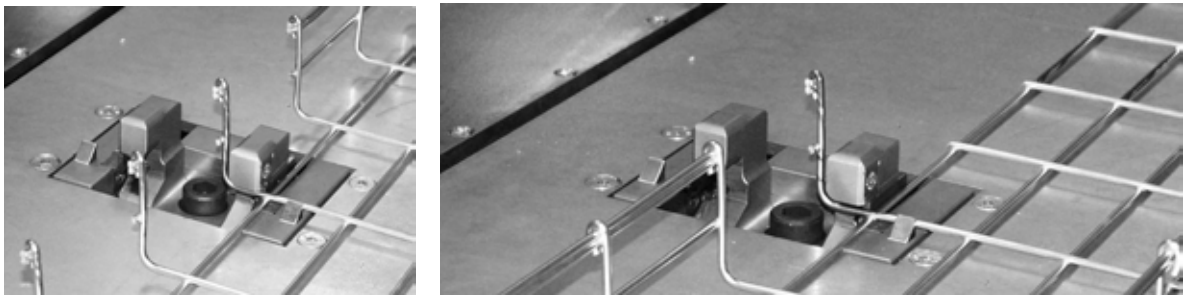
*Fig. 4.25 – Cut of base wires*

**4.3.2.6 Cut for making sharp quarter bends**

1. Prepare the cut down size of gangway by carrying out, if necessary, the top/tail cut described in Paragraph 4.3.2.5 “*Top/tail cut*”;
2. mark with an indelible pen the wires to be cut following tables in the catalogue;
3. carry out all side double cuts following the procedure for top/tail cutting described in Paragraph 4.3.2.5 “*Top/tail cut*”;
4. carry out the cut of transversal lateral wires (fig. 4.26),

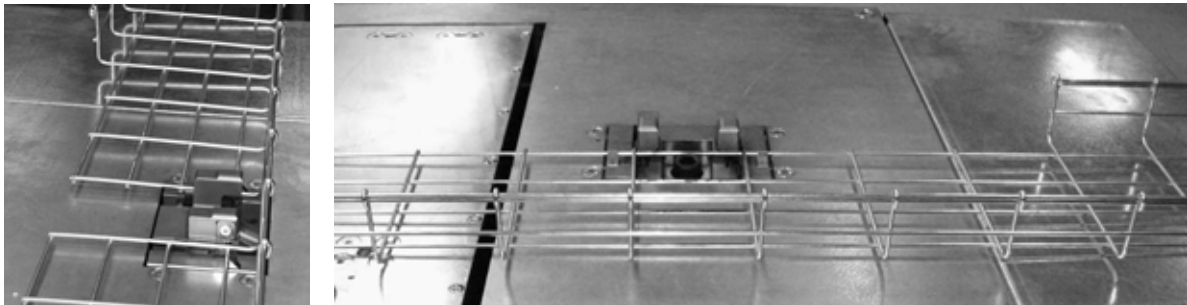


*Before cutting, check that wires under the shear are in the right position;*



*Fig. 4.26 – Cut of transversal lateral wires*


5. carry out all base cuts (fig. 4.27) following the procedure described in Paragraph 4.3.2.5 “*Top/tail cut*”.



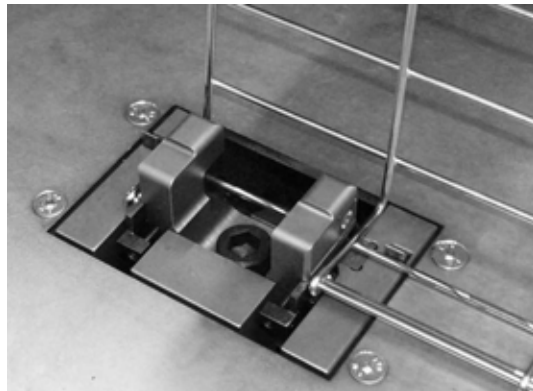
*Fig. 4.27 – Base cuts*

**4.3.2.7 Cut for making quarter bends/angles**

1. Prepare the cut down size of gangway by carrying out, if necessary, the top/tail cut described in Paragraph 4.3.2.5 “Top/tail cut”;

 *this procedure must be followed for both necessary cut down sizes.*

2. mark with an indelible pen the wires to be cut following tables in the catalogue;
3. carry out all lateral double cuts (fig. 4.28) following the procedure described in Paragraph 4.3.2.5 “Top/tail cut”;

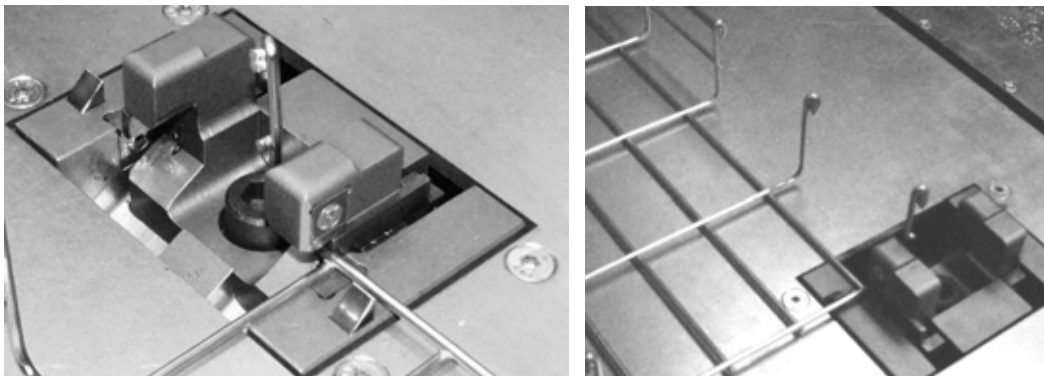


*Fig. 4.28 – Lateral double cuts*

4. cut, by a single cut, transversal lateral wires which have been isolated (fig. 4.29);



*Before cutting, check that wires under the shear are in the right position;*




*Fig. 4.29 – Cutting, by a single cut, those transversal lateral wires which have been isolated*

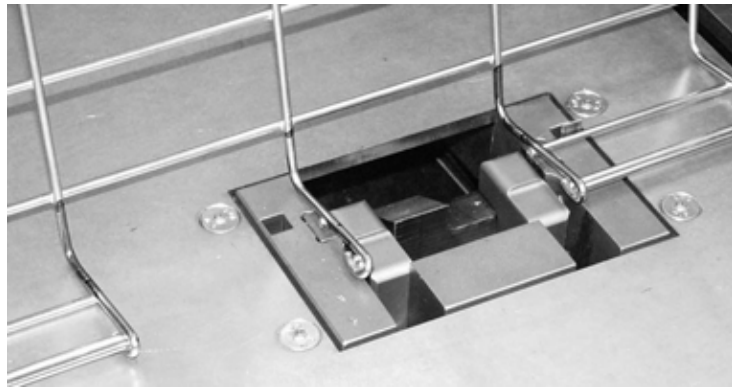


**4.3.2.8 Cut for making Tee joints**

1. Prepare the cut down size of gangway by carrying out, if necessary, the top/tail cut described in Paragraph 4.3.2.5 “Top/tail cut”;

 *this procedure must be followed for both necessary cut down sizes.*

2. mark with an indelible pen the wires to be cut following tables in the catalogue;
3. carry out all lateral double cuts (fig. 4.30) following the same procedure for top/tail cutting described in Paragraph 4.3.2.5 “Top/tail cut”;

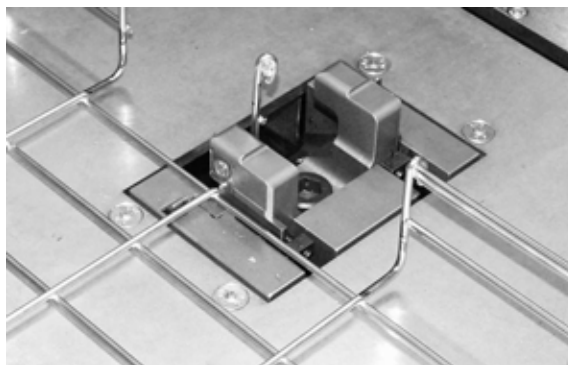


*Fig. 4.30 – Lateral double cuts*

4. carry out those possible base double cuts following the procedure for top/tail cutting described in Paragraph 4.3.2.5 “Top/tail cut”;
5. cut, by a single cut, transversal lateral wires which have been isolated (fig. 4.31);



*Before cutting, check that wires under the shear are in the right position.*

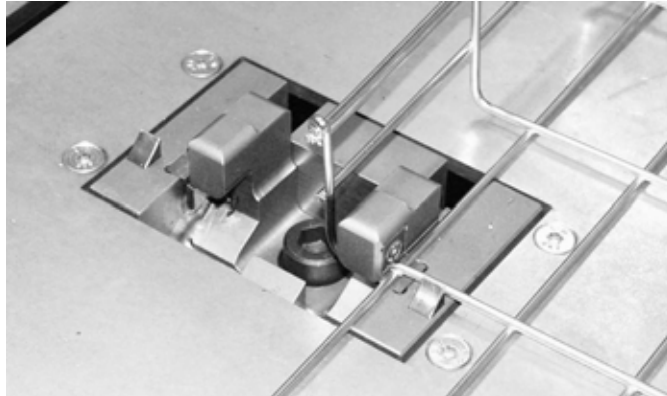


*Fig. 4.31 – Cutting, by a single cut, those transversal lateral wires which have been isolated*

6. cut, by an internal lateral single cut, the first bent part of lateral wire (fig. 4.32);



*Before cutting, check that wires under the shear are in the right position.*

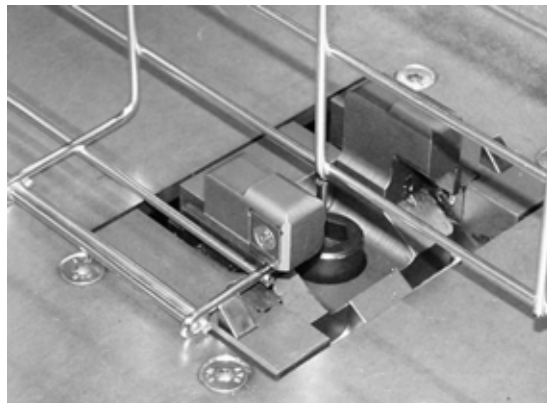


*Fig. 4.32 – Internal lateral single cut of the first bent part of lateral wire*

7. cut, by an external lateral single cut, the first bent part of lateral wire (fig. 4.33);



*Before cutting, check that wires under the shear are in the right position.*



*Fig. 4.33 – External lateral single cut of the first bent part of lateral wire*

8. go on with detaching the next one as per point 5 of this procedure until the cut of all bent parts of lateral wires is completed.




*In case of single cuts, let the shear go up as soon as wire has been completely cut. This prevents remaining wires from buckling and doesn't thicken the next cuts.*



*Always detach the part of bent wire before going on with next cuts. If you carry out all internal single cuts, it will be difficult to carry out the external single cuts.*

**4.3.2.9 Cut for making 100/200 mm Neckings**

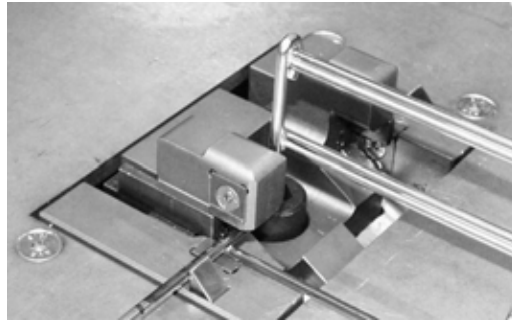
1. Prepare the cut down size of gangway by carrying out, if necessary, the top/tail cut described in Paragraph 4.3.2.5 “Top/tail cut”;

 *this procedure must be followed for both necessary cut down sizes.*

2. mark with an indelible pen the wires to be cut following tables in the catalogue;
3. cut, by an internal lateral single cut, the first bent part of lateral wire (fig. 4.34);



*Before cutting, check that wires under the shear are in the right position.*



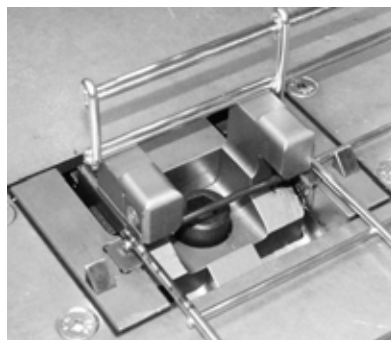
*Fig. 4.34 – Single cut of the first bent part of lateral wire*

4. cut, by an external lateral single cut, the first bent part of lateral wire;




*Before cutting, check that wires under the shear are in the right position.*

5. go on with cutting the next one as per points 3 and 4 of this procedure until the cut of all bent parts of lateral wires is completed.;
6. carry out all base double cuts (fig. 4.35) following the procedure for top/tail cutting described in Paragraph 4.3.2.5 “Top/tail cut”;



*Fig. 4.35 – Base double cuts*

7. as regards the wider cut down size, cut, by a single cut, the part of base wire 50 mm long which is remained from the previous cut (fig. 4.36).

 To the narrower cut down size you cannot carry out this kind of cut;

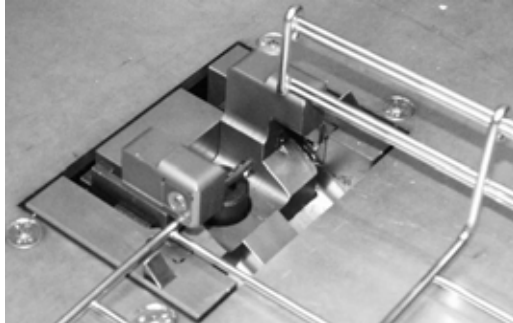




Fig. 4.36 – Cut of the part of base wire

 In case of single cuts, let the shear go up as soon as wire has been completely cut. This prevents remaining wires from buckling and doesn't thicken the next cuts.

 Always detach the part of bent wire before going on with next cuts. If you carry out all internal single cuts, it will be difficult to carry out the external single cuts.

#### **4.3.2.10 Cut for making up and/or downgrade bends**

1. Prepare the cut down size of gangway by carrying out, if necessary, the top/tail cut described in Paragraph 4.3.2.5 “Top/tail cut”;
2. mark with an indelible pen the wires to be cut;
3. carry out all lateral double cuts following the procedure for top/tail cutting described in Paragraph 4.3.2.5 “Top/tail cut”;

#### **4.3.2.11 Drawing wires from cutting station in case of wrong insertion**

In case of wrong positioning of wires under the shear, locks **1** and **2** (fig. 4.37) prevent them from drawing.

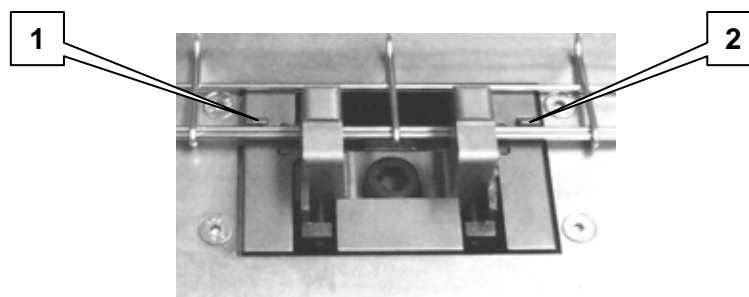
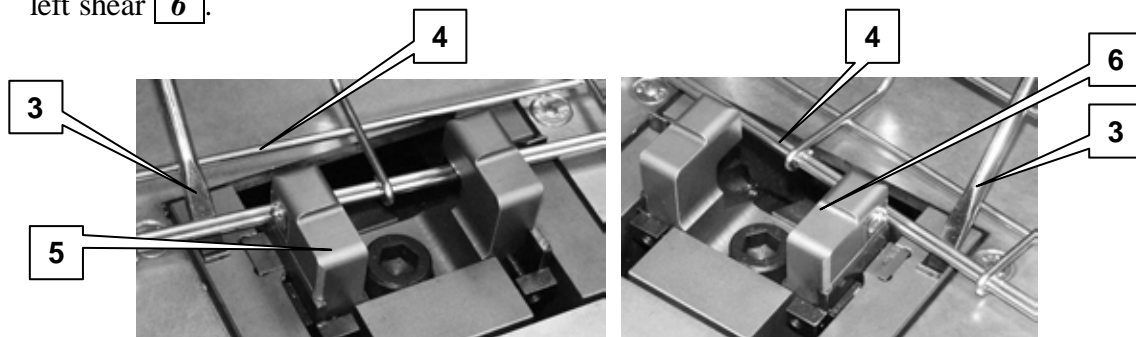


Fig. 4.37 – Wires locked

In this case it is necessary to operate as follows:

1. push downwards the boss **1** (see fig. 4.37) with the screwdriver **3** and pull the gangway **4** drawing out the wires of right shear **5**; repeat the same operation for the left shear **6**.

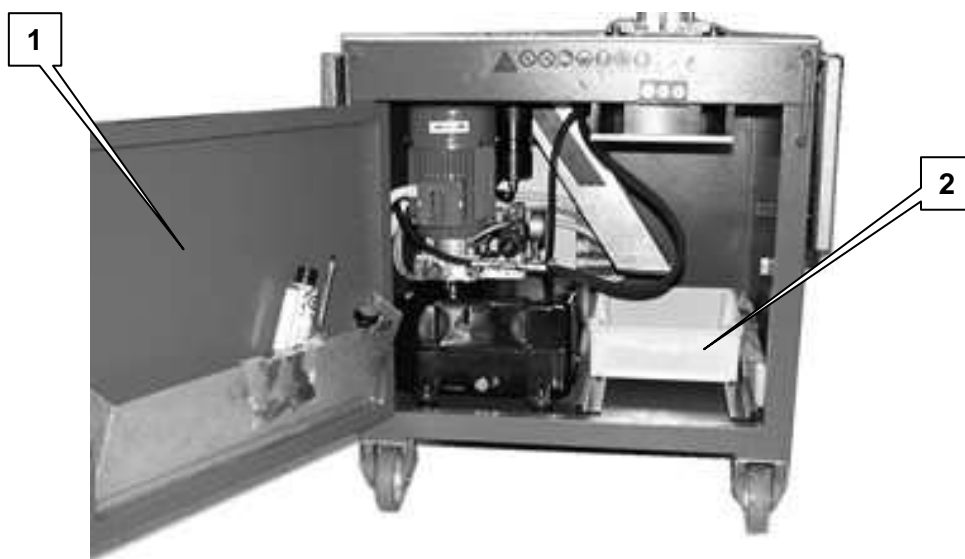


*Fig. 4.38 – Wires unlock*

**4.3.2.12 Emptying of the box for scraps**

In order to empty the box for scraps it is necessary to follow this procedure (fig. 4.39):

1. open the rear door **1** of the machine by means of a setscrew wrench;
2. take away the box **2**.



*Fig. 4.39 – Box for scraps*



*Scraps from cutting operation must be disposed according to rules in force in the country where the machine is used.*

### 4.3.2.13 End of cutting operation

1. At the end of cutting operations, press, with your foot, the control pedal and keep it pressed until the shear goes down;
2. to carry out bending operations see paragraph 4.3.3 “Bending operations”
3. if all cutting and bending operations are finished, switch off the machine as mentioned in paragraph 4.3.4 “*Machine switching off*” of this Chapter.



### 4.3.3 Bending operations



*Before starting any working, always check the good condition of the bar to be bent, avoiding to use parts already deformed by transport.*



*All data mentioned in Annex I “Bending parameters” have been checked and are suggested in order to reach the best results for 45° and 90° bends. They have to be considered as an approximate parameter because they are influenced by bending modes, deformation and geometric variability of gangways. Besides, all data mentioned in columns indicator, overall dimensions and bend radius are approximate because they are influenced by normal tolerances of used materials (hardness, elasticity, treatments, etc.) and by variables of stressed parts of the equipment (flexure/wear/pivot adjustment, pushers, arms).*



*The responsibility for any damages to things and/or people resulting from improper operations carried out by unskilled or unauthorised personnel rests only on that personnel, including bending of gangways which are not manufactured by GEWISS or other products.*

#### 4.3.3.1 Important notes on bending operations



*In case of slightly buckled gangways, manually restore buckling as far as possible and use shaped knobs ( **2** in fig. 4.40) (supplied already screwed to arms) in order to hold the position of end wires during bending.*



*During bending, check that the wires do not get out from plugs ( **6** and **7** in fig. 4.40); if this occurs, stop and connect the above mentioned shaped knobs ( **2** in fig. 4.40); in general this problem is caused by those bucklings not restored in sectors previously bent.*



*In case of interference among plugs ( **6** and **7** in fig. 4.40) and any longitudinal wire of the bar to be worked, check if by turning it 180° the problem disappear. Otherwise, it is possible to cut out-of-pitch wires and proceed as usual. **N.B.** if the bar has all out-of-pitch wires, use it only for straight parts and inform the Retailer by giving the supply data (code PF, date, lot).*



*If the radius of the carried out bend is less than the wanted one, it is possible to improve it by cutting (with a manual shear) one or more bent sectors adjusting and locking with ordinary bolt jointing devices.*

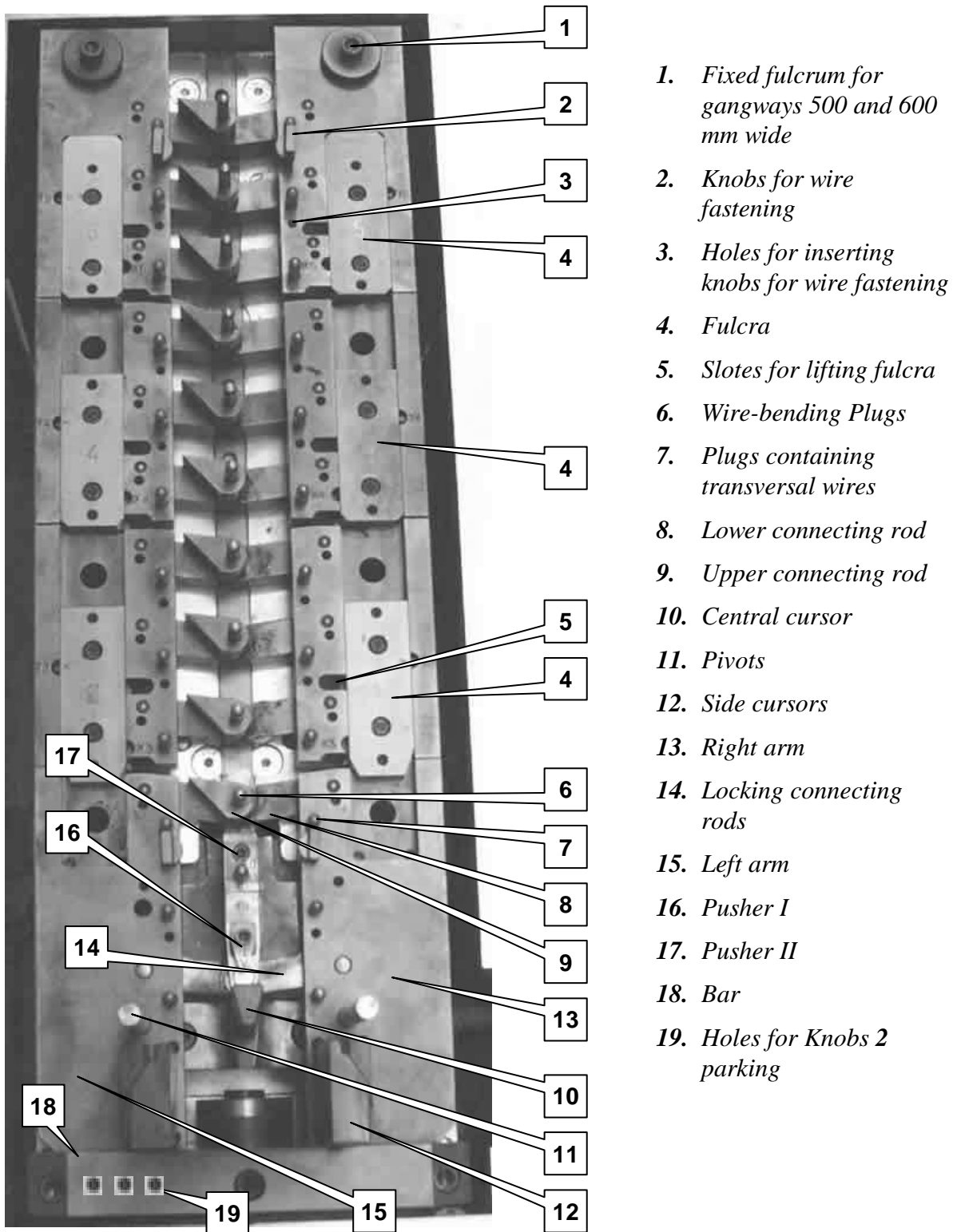


*If the radius of the carried out bend is more than the wanted one, it is possible to improve it by rewelding one or more bent sectors until the desired radius is obtained.*



*In case of buckling during bending (warping) it is possible to restore the curve flatness by keeping locked the sector under bending and by working in proper way (manually or with the help of a lever for bigger measures) on free parts.*

**4.3.3.2 Description of the bending station and description of the bending cycle**



1. *Fixed fulcrum for gangways 500 and 600 mm wide*
2. *Knobs for wire fastening*
3. *Holes for inserting knobs for wire fastening*
4. *Fulcra*
5. *Slotes for lifting fulcra*
6. *Wire-bending Plugs*
7. *Plugs containing transversal wires*
8. *Lower connecting rod*
9. *Upper connecting rod*
10. *Central cursor*
11. *Pivots*
12. *Side cursors*
13. *Right arm*
14. *Locking connecting rods*
15. *Left arm*
16. *Pusher I*
17. *Pusher II*
18. *Bar*
19. *Holes for Knobs 2 parking*

*Fig. 4.40 – Bending station in standard position*



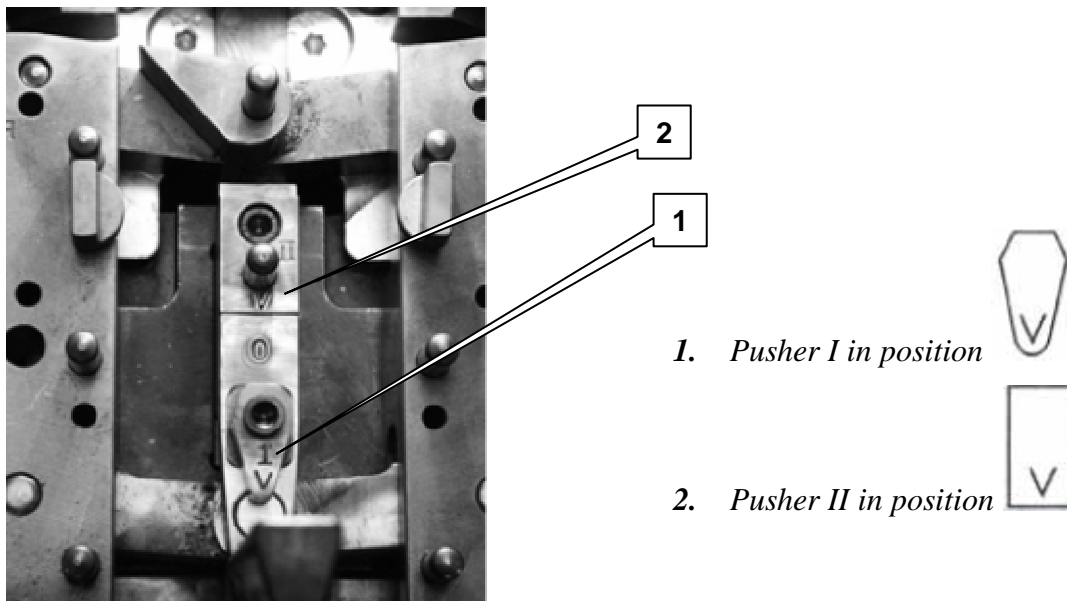


Fig. 4.41 – Enlargement of pushers views

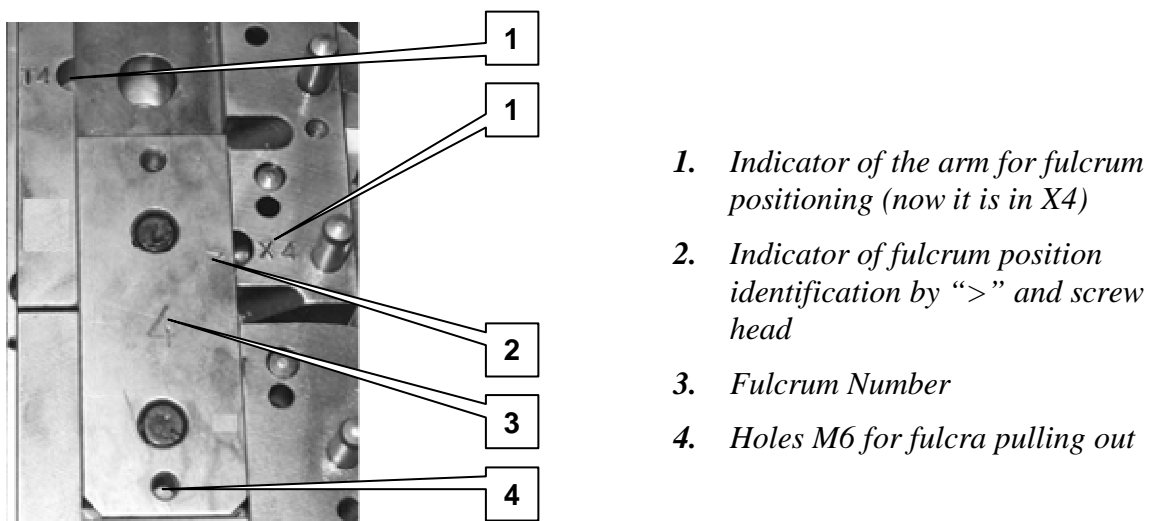


Fig. 4.42 – Fulcrum 4 enlargement

### Description of the cycle

Any time you press the pedal you carry out the movement opposite to the previous one; if after the last operation the bending station closes, at the next operation it opens and viceversa. If, for any reason, an undesired movement occurs it is possible to select the wanted one by pressing on the pedal for a few seconds. In this way the station has not time enough to move and at the following start the station will operate as you desire.

### 4.3.3.3 Arrangement of the bending station

Before starting any bending operation it is necessary to arrange the bending station and follow this procedure:

#### Positioning:

1. check that the shear is completely lowered. Otherwise, lower it by following the procedure in Paragraph 4.3.2.13 “End of cutting operation”.
2. pull out and turn 90° the locking ball grip **1**;
3. open the handle **2**;
4. turn counterclockwise the bending station for a 180° angle and position it upwards;
5. fix the bending station by turning 90° the locking ball grip **1**. Slightly turn the station around its hooking point until you notice the locking of rotation.

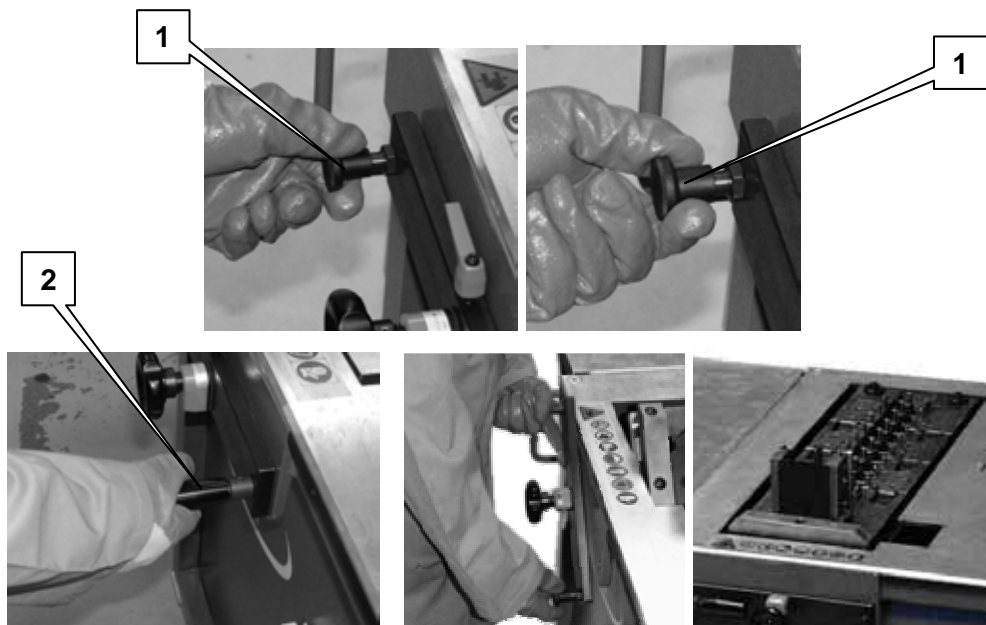



Fig. 4.43 – Bending station positioning


#### Arrangement of the bending station:

In tables of Annex I “Bending Parameters” there are all parameters and adjustments to be carry out at the bending station considering the type of surface finishing, the gangways width and the bending angle you want (45° or 90°).

To prepare the bending station:

 *The responsibility for any damages to things and/or people resulting from improper operations carried out by unskilled or unauthorised personnel rests only on that personnel.*

1. take the bending station to standard position (arms **13** and **15** parallel as in fig. 4.40);
2. find in tables of Annex 1 “*Bending Parameters*” the configuration of pusher I (see fig. 4.41) and reposition it in case it is not on required position. To reposition pusher I it is necessary to proceed as follows (fig. 4.44):

 *The orientation of pushers, outlined in the above mentioned tables, is shown by a V, and it refers to the operator position connected with the machine side where the electrical control board is placed (see fig. 4.41).*

- 2.1 unscrew, by a 5 mm setscrew wrench, fastening screw **4** of pusher I **3**;
- 2.2 lift pusher I **3**, turn it by 180° and reposition it in its seat;
- 2.3 retighten fastening screw **4** of pusher I **3**.

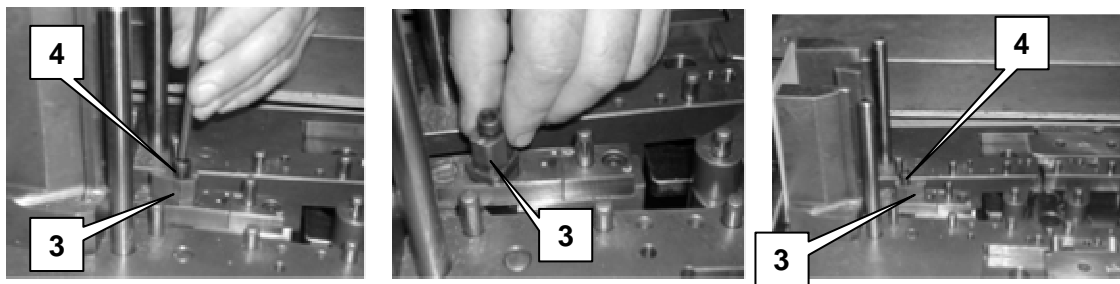


Fig. 4.44 – Pusher I

3. find in tables of Annex 1 “*Bending Parameters*” the configuration of pusher II (see fig. 4.41) and reposition it in case it is not on required position. To reposition pusher II it is necessary to proceed as follows (fig. 4.45):

- 3.1 unscrew, by a 5 mm setscrew wrench, fastening screw **5** of pusher II **6**;
- 3.2 lift pusher II **6**, turn it by 180° and reposition it in its seat;
- 3.3 retighten fastening screw **5** of pusher II **6**.

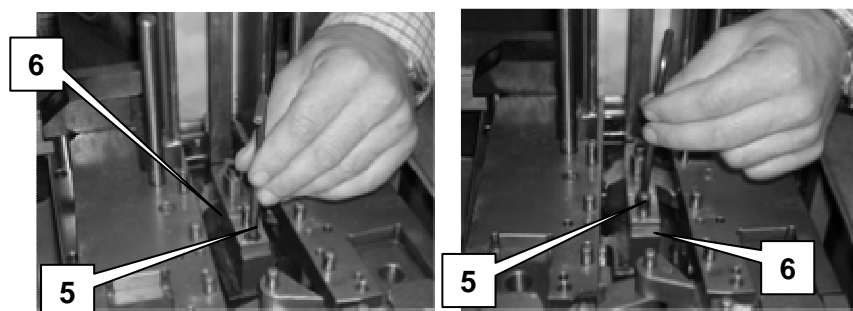
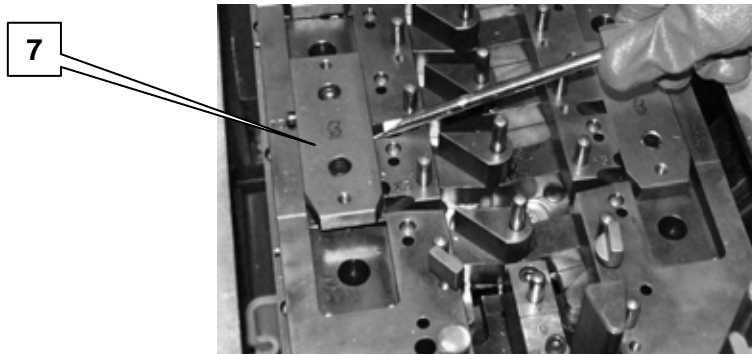


Fig. 4.45 – Pusher II

4. find in tables of Annex 1 “*Bending Parameters*” the configuration of fulcrum N 3 and proceed to a possible variation in case it is not on required position. If you find wording R - L go to point 8 (insertion of long fulcra). Description of the transition from position T3 to X3:

4.1 lift with the screwdriver left fulcrum 3 7 (fig. 4.46);



*Fig. 4.46 – Lifting left fulcrum 3*

4.2 pull out left fulcrum 3 (fig. 4.47);



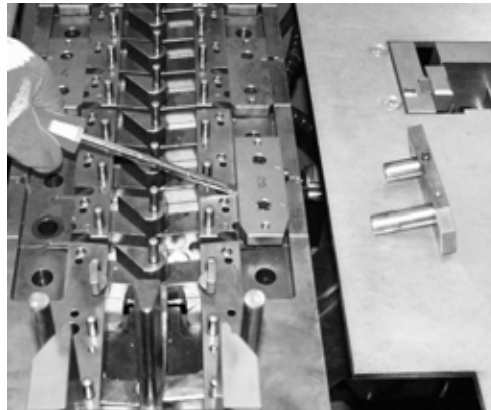
*Fig. 4.47 – Pulling out left fulcrum 3*

4.3 place left fulcrum 3 on the right of the station (fig. 4.48);



*Fig. 4.48 – Positioning of first fulcrum 3 on the worktable*

**4.4** lift with the screwdriver right fulcrum 3 (fig. 4.49);



---

*Fig. 4.49 – Lifting up of the second right fulcrum 3*

**4.5** pull out right fulcrum 3 (fig. 4.50);



---

*Fig. 4.50 – Pulling out right fulcrum 3*

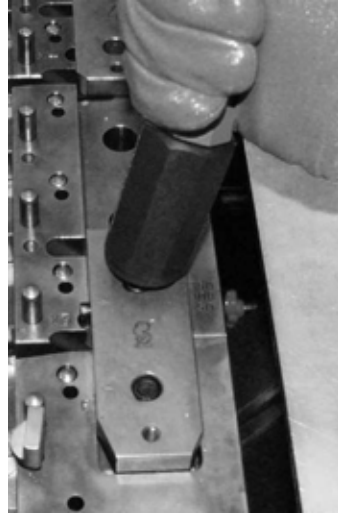
**4.6** insert right fulcrum 3 in the arm with Position X3 on the left (fig. 5.51);



---

*Fig. 4.51 – Positioning of second right fulcrum 3 in the arm with position X3 on the left*

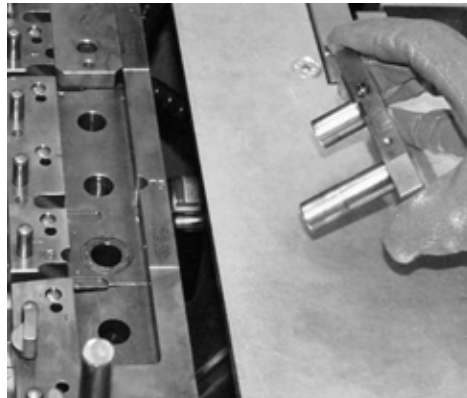
**4.7** insert right fulcrum 3 with a sharp blow (fig. 4.52);



---

*Fig. 4.52 – Insertion of right fulcrum 3*

**4.8** grasp fulcrum 3 placed on the right (fig. 4.53);



---

*Fig. 4.53 – Grasp of fulcrum 3 placed on the right*

**4.9** insert fulcrum 3 placed on the right in position X3 right (fig. 4.54);



---

*Fig. 4.54 – Positioning of fulcrum 3 placed on the right*

4.10 insert fulcrum 3 with a sharp blow (fig. 4.55);

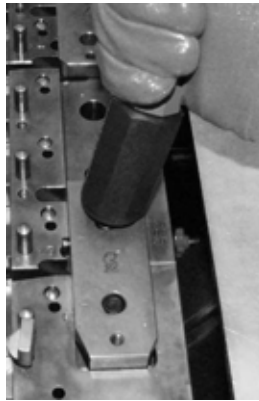


Fig. 4.55 – Insertion of fulcrum 3

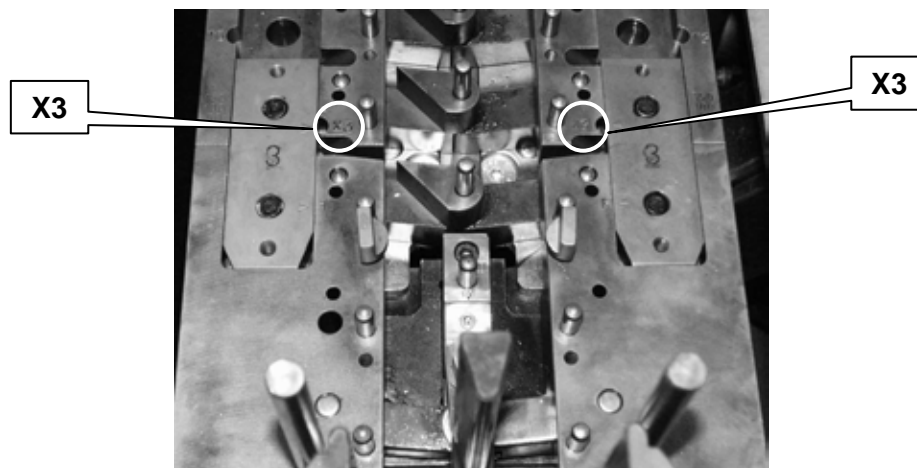


Fig. 4.56 – Fulcrum N 3 repositioned

- ☞ *The two fulcrum must be completely inserted in the arms; they cannot lean out.*
  - check they are both on position X3 (fig. 4.56);
  - ☞ *Never turn fulcrum by 180°; the long pivot is always on the front and numbers can be seen straight from the operator side. Pay your best attention to the order in conversion operation.*
  - ☞ *Fulcrum N3 can be inserted only on positions X3 and T3 (the second letter of the position means the fulcrum number).*
  - ☞ *the same procedure should be followed for transition from position X3 to T3; at points 4.6 and 4.9 fulcrum will be inserted in position T3.*
5. check the fulcrum are in the right position. Checking procedure:
- 5.1 the operator, looking from its working position, must always see the number of the fulcrum in the correct way of reading; if it is turned upside-down, the fulcrum must be turned 180°. The long pivot must be always in the position nearest to the operator;

- 5.2 Fulcrum N has to be positioned so that sign **8** (fig. 4.57) (screw head + V) means XN or TN (for example: 4 means X4 or T4, 5 means X5 or T5, 3 means X3 or T3). If sign doesn't find symbol (as shown in the photo) you need to try to insert fulcrum in the opposite arm ( in the case of fig. 4.57 you have to insert it in the left arm).
- 5.3 Check periodically the presence of the head of screws **8** and **9** (fig. 4.57); if they are missing, they must be immediately restored.
- 5.4 If fulcrum is in the right position, it turns out to be complete as regards its parts and fully inserted in its seat. It cannot lean out of the arm **10** (fig. 4.57).

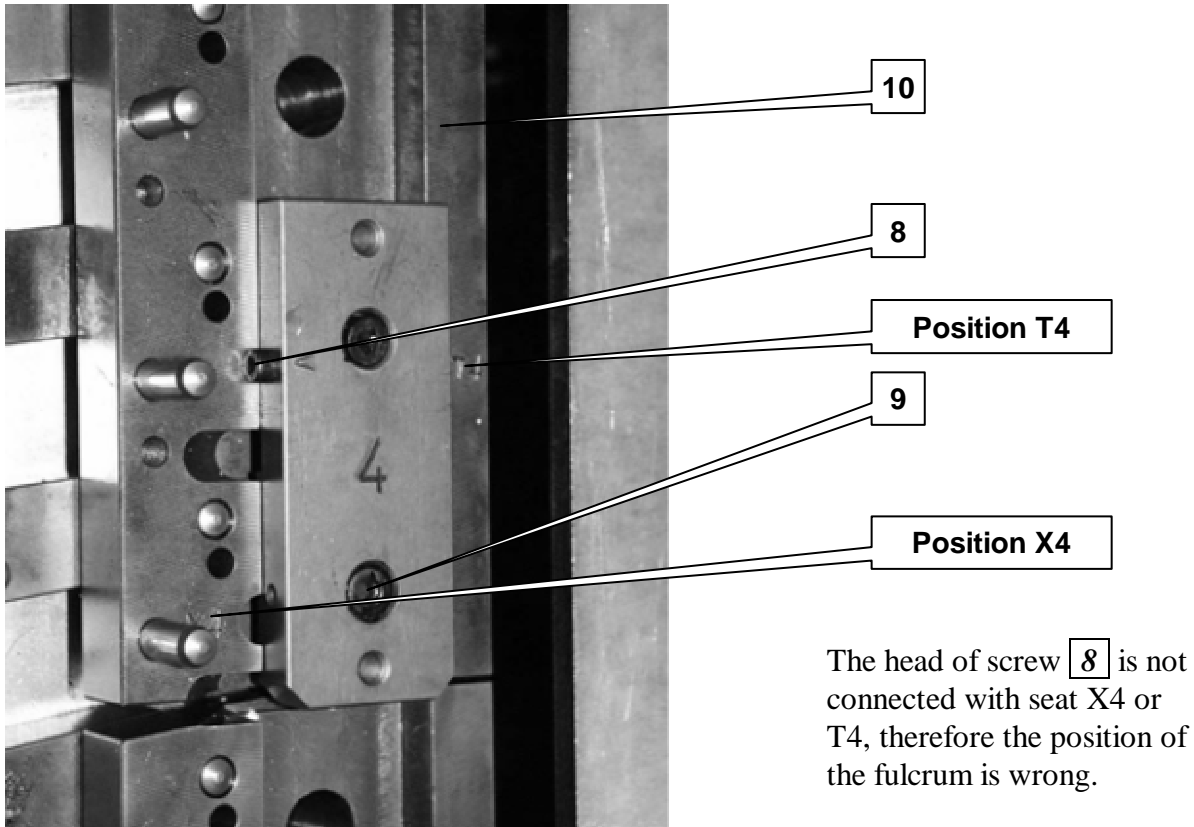


Fig. 4.57 – Example of fulcrum wrong positioning

6. find in tables of Annex 1 “*Bending Parameters*” the configuration of fulcrum N 4 and proceed to a possible variation in case it is not on required position. Follow the same procedure described in points 4 and 5.

 *Fulcrum N4 can take positions X4 and T4*

7. find in tables of Annex 1 “*Bending Parameters*” the configuration of fulcrum N 5 and proceed to a possible variation in case it is not on required position. Follow the same procedure described in points 4 and 5.

 *Fulcrum N5 can take positions X5 and T5*



8. if in the table there is the wording **R-L** (setting of gangway bending for 500 and 600 mm gangways) you need to follow this procedure:

8.1 pull out fulcra 3, 4 and 5 **11** and place them on the machine rear side (fig. 4.58);

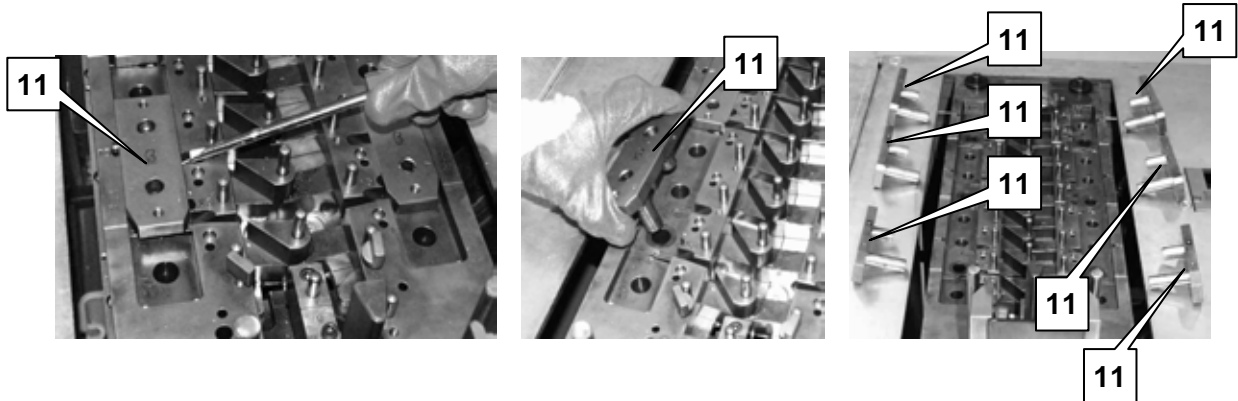


Fig. 4.58 – Pulling out fulcra 3, 4 and 5

8.2 take off from the machine rear side fulcra **R-L** **12**, insert **R** in the right seat and **L** in the left seat, making sure that they are well positioned and pushed down by some well delivered blows with the scredriver handle. Fulcra must be completely inserted (surface **A** has to lean over surface **B**) (fig. 4.59);

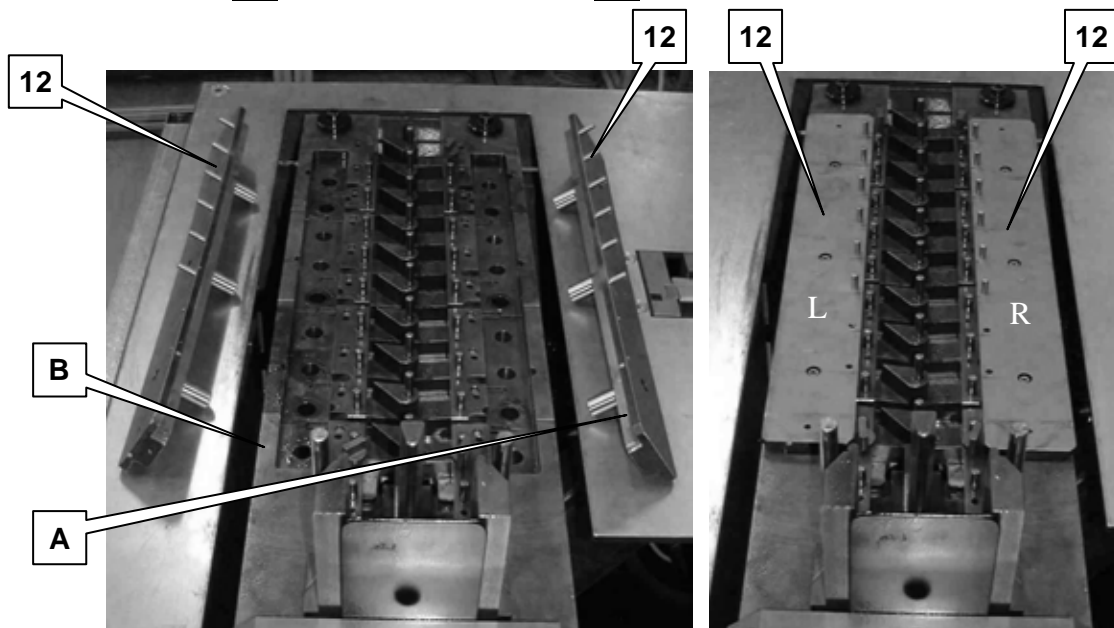


Fig. 4.59 – Insertion of fulcra R-L

☞ To change from configuration R-L to the others such as T3,T4,T5 follow the same procedure. Fulcra R-L must be pulled out and placed on the machine rear side; fulcra 3,4,5 must be placed according to directions given in the table (for standard position we have 3 in T3, 4 in T4, 5 in T5).

- 8.3 if pulling out fulcra turns to be difficult, with a screwdriver insert two screws M6 (on issue) **13** in free threaded holes and tighten them alternatively for 1 turn till the complete pulling out (fig. 4.60);

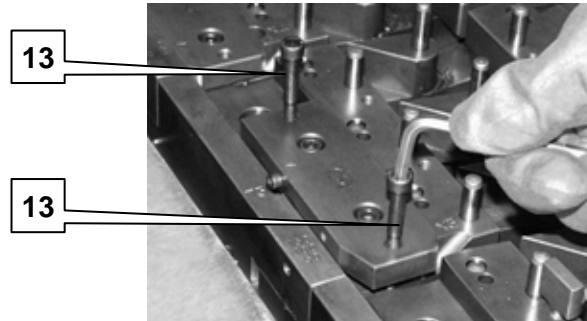


Fig. 4.60 – Pulling out of fulcra 3, 4 and 5

9. find in tables of Annex 1 “Bending Parameters” the indicator number and set it on the dial by turning knob as follows:

- 9.1 unlock lever **14** (fig. 4.61);

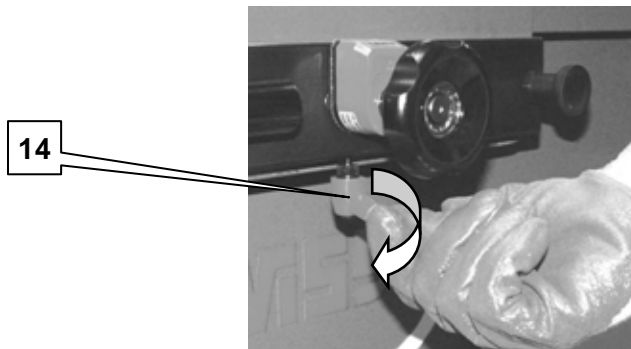


Fig. 4.61 – Lever unlocking

- 9.2 turn knob **15** (fig. 4.62);

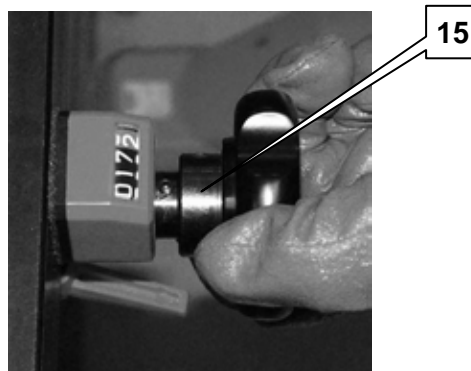


Fig. 4.62 – Knob turning

9.3 lock knob **15** by the lever **14** (fig. 4.63);

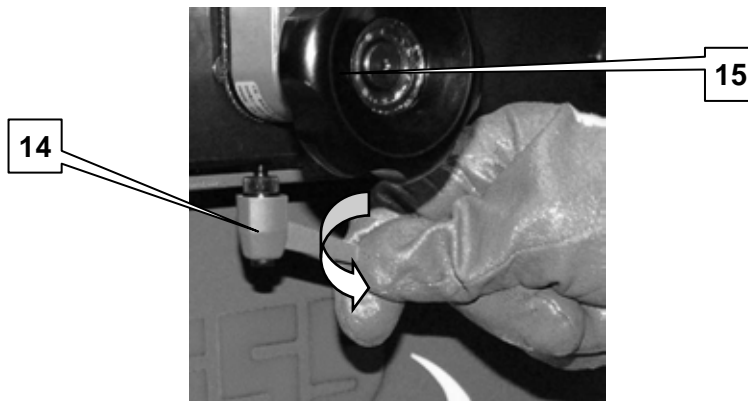


Fig. 4.63 – Knob locking



Check that the lever **14**, on locked position, is parallel to the bar **16**. If it is in another position it prevents tilting of the bending station and it could break.

9.4 if it is not on a right position it has to be lowered and turned in order to let it to the shown in the figure with locked knob. The screw **17** must always be locked (fig. 4.64).



Fig. 4.64 – Right position


#### 4.3.3.4 Bending operations for gangways from 50 mm to 500 mm

☞ At a parity of product, for angles different from those mentioned in the table of Annex I “Bending parameters”, it is necessary to proceed step by step using the arrangement for those type of gangway; making attempts you have to change the indicator adjustment (we suggest to start from the one proposed for 90° bends and increase it as needed) and check the result during the gangway laying or by a simple template (made, for example, of cardboard).


☞ Never use indicator values for a certain type of gangway lower than the one suggested for making quarter bends.

In order to carry out properly the bend of gangways, it is necessary to follow this procedure:

1. arrange the bending station as shown in Paragraph 4.3.3.3 “*Bending station arrangement*” of this Chapter;

 *After any change of bend type to carry out (finishing, dimensions, angle) you have to arrange again the bending station*

2. switch on the machine as shown in Paragraph 4.3.1 “*Machine starting*” of this Chapter;
3. insert the median sector of the bend/curve to be worked **1** as shown in fig. 4.65, making sure that wires are properly positioned between pivots **2** and **3** through all its width (fig. 4.65).

 *If the bend consists of 11 sectors, the median sector is the 6<sup>th</sup>; if it consists of an even number of sectors, choose the one adjacent to the centre line.*

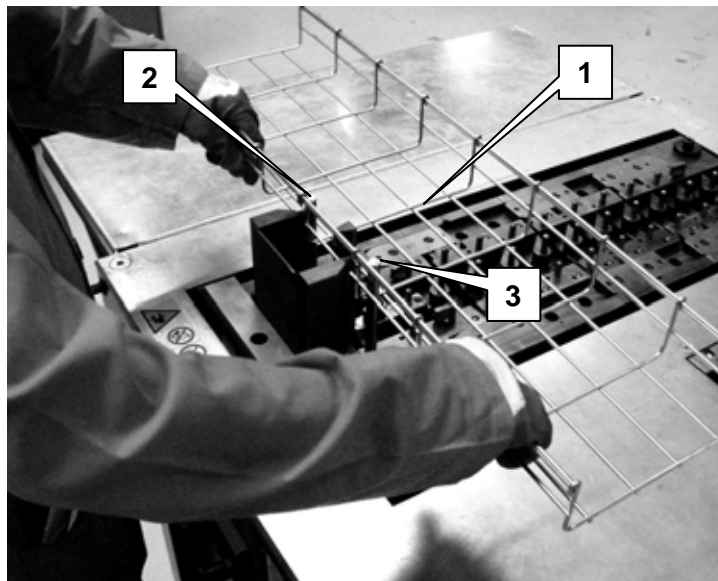


Fig. 4.65 – Gangway positioning

4. push downwards the gangway **4** until it leans on the arms **5** (fig. 4.66);

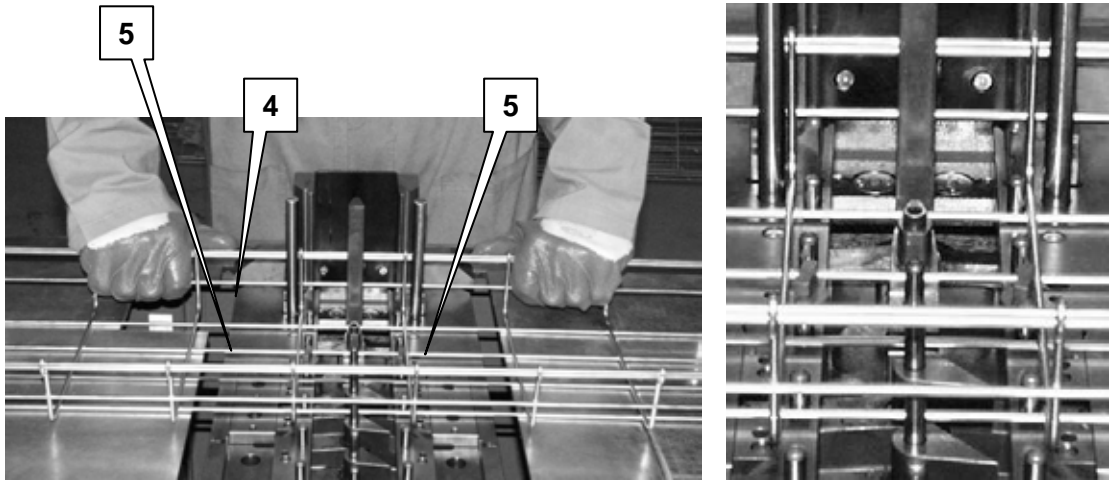


Fig. 4.66 – Gangway positioning

5. Check that all transversal wires **6** are out from plugs **7** (fig. 4.67);

☞ Check that the wires **A** are out of lateral cursors **B** and inside the pivots **2** and **3** (fig. 4.67).

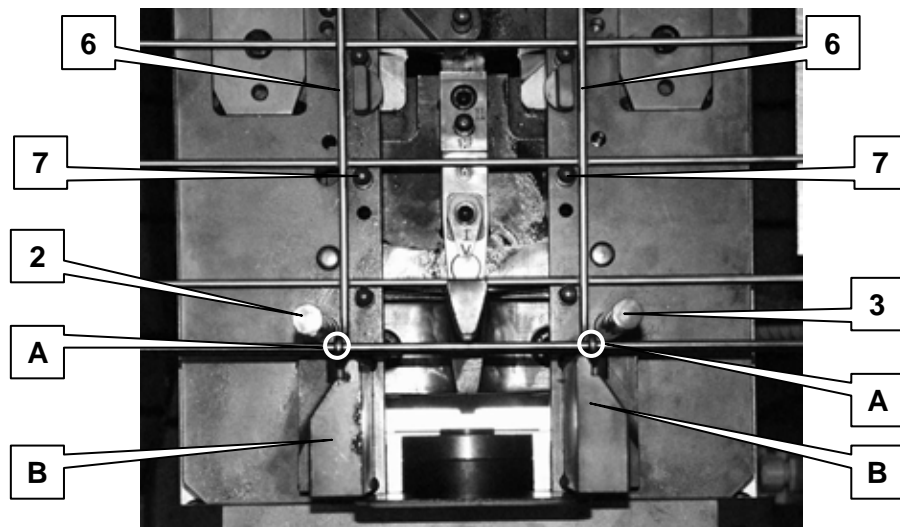


Fig. 4.67 – Gangway positioning

☞ Check that all transversal wires lean properly on the arms.

6. If any part of transversal wire **8** is slightly lifted (> of 3 mm) or if during bending the wires tend to lift, apply knobs for keeping wires near arms. Usually this drawback is due to a gangway buckled during handling or previous bending. In this case it is useful to apply knob **9** by screwing it clockwise until the wire is blocked (fig. 4.68).

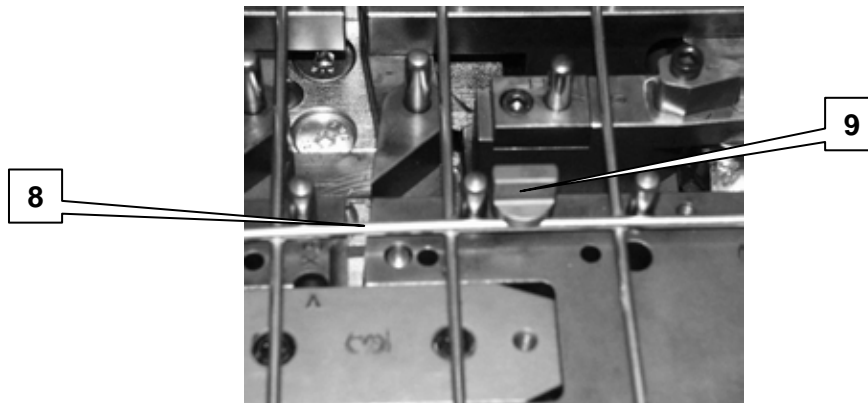




Fig. 4.68 – Knob application

7. keep the gangway **4** pressed on the worktable **10** by pushing with your hands in both sides (fig. 4.69);

 Keep your hands on upper wires of front edge **11**, do not insert fingers or palms under wires because during bending wires could shift (fig. 4.69).

8. press with your foot the control pedal, release it at the end of stroke.

 Keep hands, during this phase, in a safety position as shown in this fig..

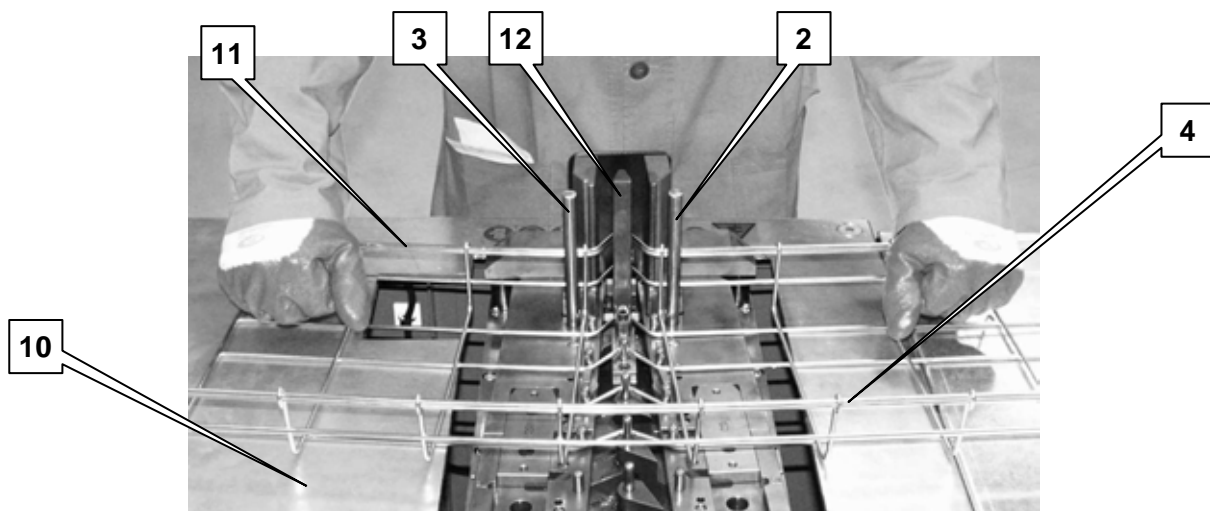
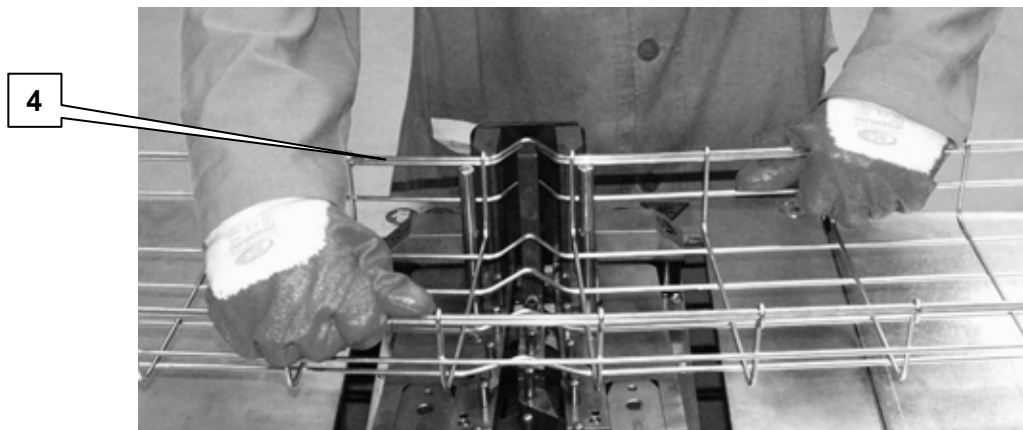


Fig. 4.69 – Bending phase

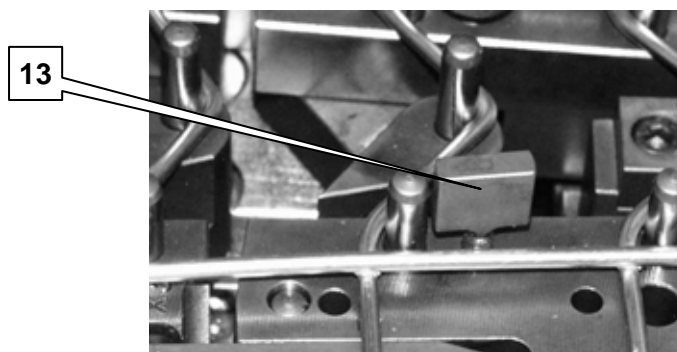
9. press, with your foot, the control pedal in order to release wires just bent. Do not withdraw more than one millimetre cursor **12** (fig. 4.69);

10. pull gangway **4** out of the bending station by pulling it upwards (fig. 4.70);



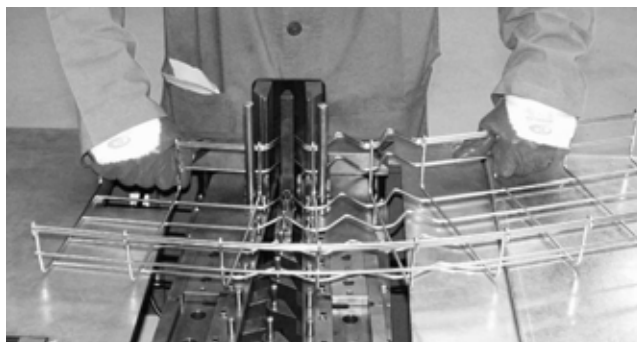
*Fig. 4.70 – Gangway pulling out*

☞ When you use knobs for locking wires **13** (fig. 4.71) you have to unlock them, before pulling out the bend, by turning them half turn counterclockwise.



*Fig. 4.71 – Use of knobs for locking wires*

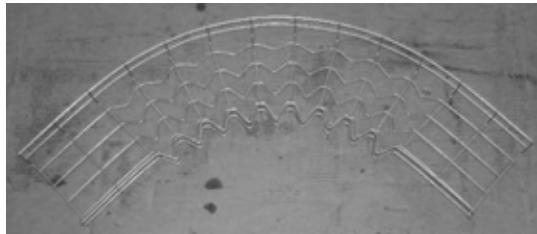
11. press, with your foot, the control pedal and take the station to standard position (arms **13** and **15** of fig. 4.40 parallel);
12. repeat the cycle until the number of bends mentioned in the tables in Annex I “*Bending Parameters*” is completed (fig. 4.72);



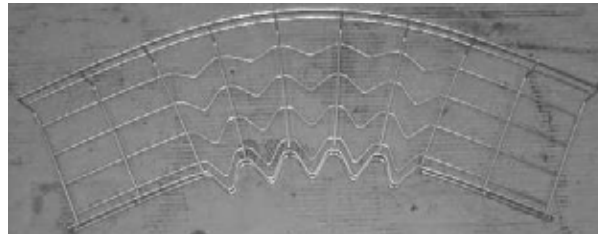
*Fig. 4.72 – Repetition of bending operations*

- ☞ *In order to guarantee the right positioning of the gangway during bending, in the tables of Annex I “Bending Parameters” are always considered two linear sectors before and after the bent part. This allows also to use all GEWISS devices for a quick fastening (see codes in GEWISS catalogue).*
- ☞ *We suggest to go on with the next bends by alternating a bend on the right of the central bend and a bend on the left, so that you can get a homogeneous bending.*
- ☞ *In case knobs for locking wires **2** (see fig. 4.40) hinder the bending of smallest gangways, screw them inside holes **19** (see fig. 4.40)*

**13.** At the end of bending operations, the gangway turns to be as shown in the following figure (fig. 4.73).



*Quarter bend (90°)*



*45° bend*

---

*Fig. 4.73 – Finished bend*



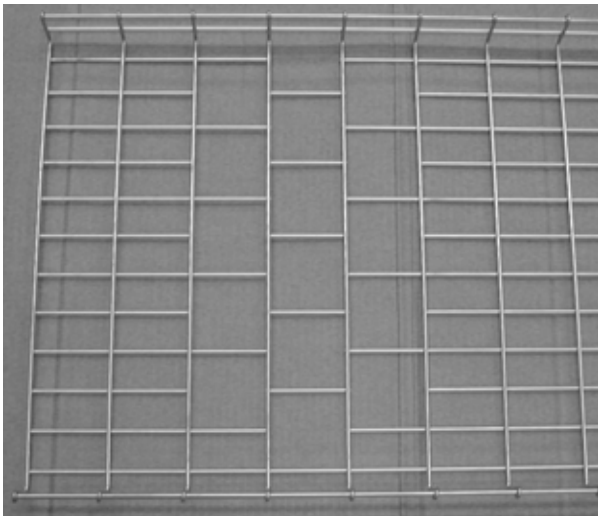
#### 4.3.3.5 Making bends for 600 mm gangways

To carry out the kind of bend, you need to cut wires in a special way; therefore it is necessary to proceed as follows:

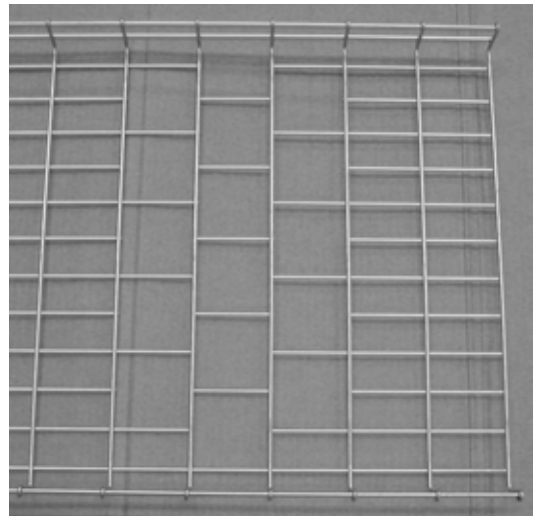
1. arrange the bending station as shown in Paragraph 4.3.3.3 “*Bending station arrangement*” of this Chapter;

☞ *After any change of bend type to carry out (finishing, dimensions, angle) you have to arrange again the bending station*

2. carry out the alternate cut of wires in three side sectors on the left and on the right as shown in this figure; always leave the top and tail sectors (fig. 4.74);



*View of the left extreme on operator side*

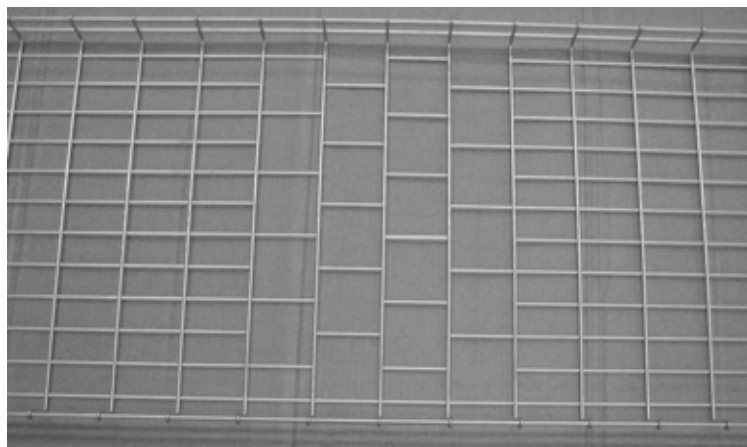


*View of the right extreme on operator side*

---

*Fig. 4.74 – Alternate cuts for bending on 600 mm gangway*

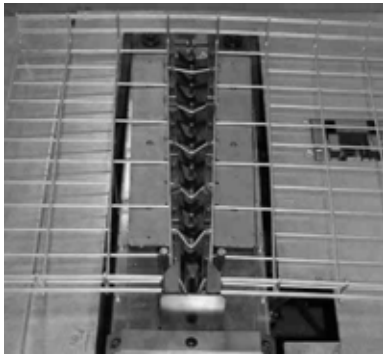
3. carry out, only for quarter bends, the alternate cut of wires in 4 central sectors of the gangway (fig. 4.75);



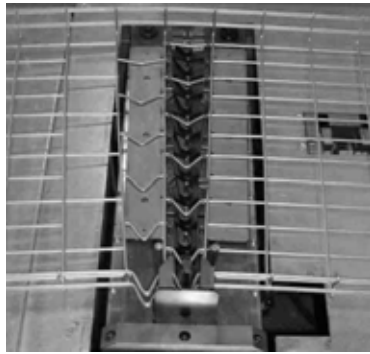
---

*Fig. 4.75 – Alternate cuts of wires in 4 central sectors for quarter bends*

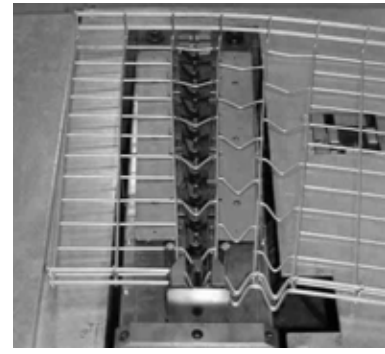
4. carry out the bending of the 3 left side sectors which have undergone an alternate cut (fig. 4.76) as shown in points 3 ÷ 11 of Paragraph 4.3.3.4 “*Making bends for gangways from 50 mm to 500 mm*”;



*Bend of central sector*



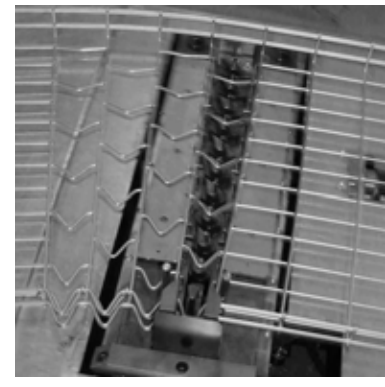
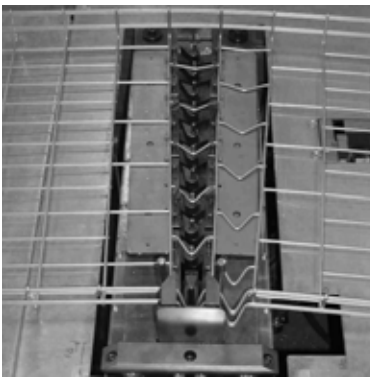
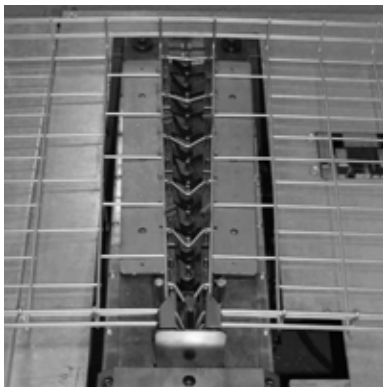
*Bend of internal side sector*



*Bend of external side sector*

*Fig. 4.76 – Bend of the 3 left side sectors which have undergone an alternate cut*

5. carry out the bending of the 3 right side sectors which have undergone an alternate cut (fig. 4.76) as shown in points 3 ÷ 11 of Paragraph 4.3.3.4 “*Making bends for gangways from 50 mm to 500 mm*”;
6. carry out, only for the quarter bend, the bending of central sectors which have undergone the alternate cut (fig. 4.77), as shown in points 3 ÷ 11 of Paragraph 4.3.3.4 “*Making bends for gangways from 50 mm to 500 mm*”;



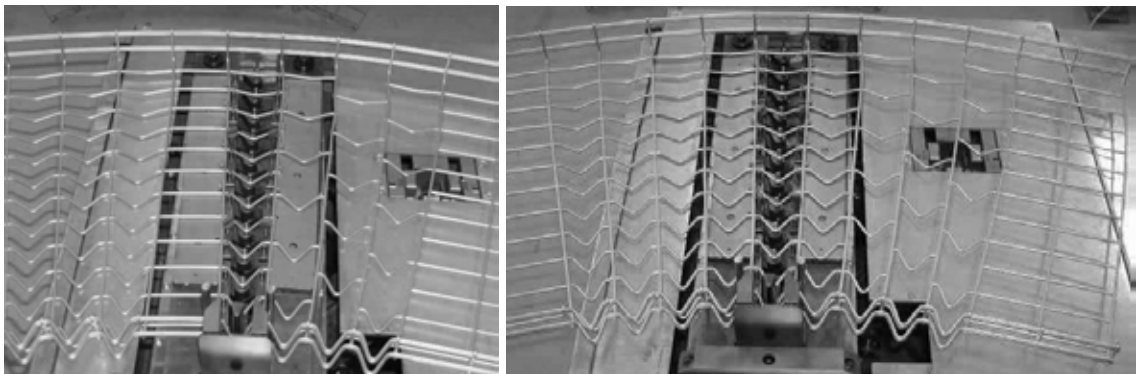
*Fig. 4.77 – Bending of 4 central sectors which have undergone the alternate cut*

7. carry out the bending of 4 left central sectors (for a 45° bend it is the same as 4 central sectors of the gangway) included among bends of alternately cut wires starting from the central zone (fig. 4.78) as shown in points 3 ÷ 11 of Paragraph 4.3.3.4 “*Making bends for gangways from 50 mm to 500 mm*”;



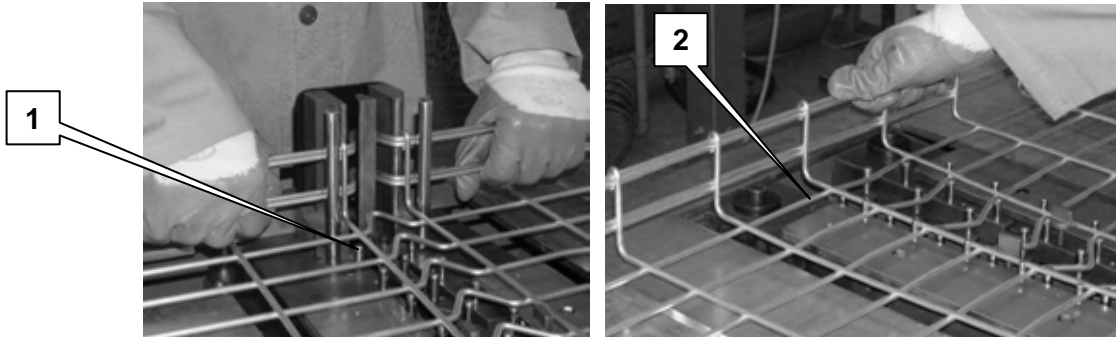
*Fig. 4.78 – Bending of 4 left central sectors included among bends of alternate cut wires*

8. Carry out, only for quarter bends, the bending of 4 right central sectors included among bends of alternate cut wires as mentioned in the previous point (fig. 4.78).
9. carry out the bending of those pairs of 2 sectors left from bending always at first the most external sector (fig. 4.79) as shown in points 3 ÷ 11 of Paragraph 4.3.3.4 “*Making bends for gangways from 50 mm to 500 mm*”;



*Fig. 4.79 – Bending of those pairs of 2 sectors left from bending always at first the most external sector*

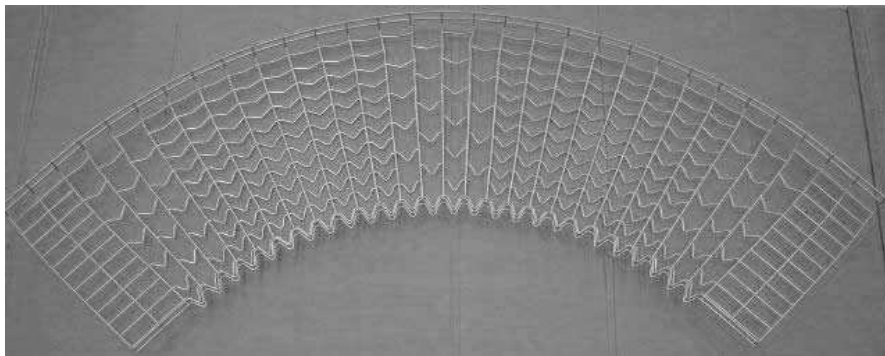
☞ To pull out easily the gangway sector after bending, open slightly the arms by lifting wires near the operator beyond plugs **1**, open again the arms by lifting wires **2** farther from operator (fig. 4.80).



*Fig. 4.80 – Pulling out the gangway sector after bending*

**Quarter bend**

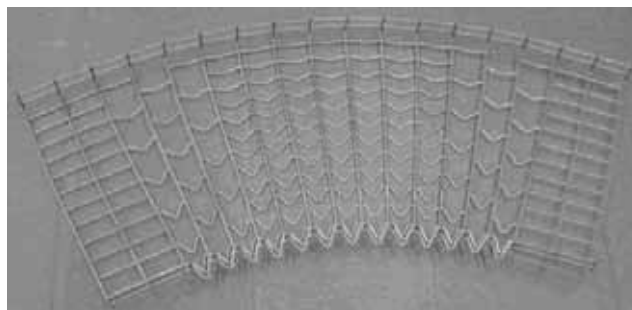
At the end of bending operations, the gangway looks like in the figure here below (fig. 4.81).



*Fig. 4.81 – Quarter bend*

**45° Bend**

At the end of bending operations, the gangway looks like in the figure here below (fig. 4.82).



*Fig. 4.82 – 45° Bend*

**4.3.3.6 End of bending operations**

1. at the end of bending operations check that the station is in standard position (arms 13 and 15 of fig. 4.40 parallel) and switch off the machine as per Paragraph 4.3.4 “Machine switching off” of this Chapter;
2. if 500 mm or 600 mm wide gangways have been bent, take off the 0 long plate and reposition fulcra 3, 4 and 5;



*To avoid components falling inside the machine, before turning downward the bending station make sure that pushers I and II and fulcra 3, 4 and 5 are properly clamped by a special net fastened with 4 knobs (see fig. 3.7 of Chapter 3 “Installation and connection”).*

3. pull out and turn by 90° blocking knob 1 (fig. 4.83);

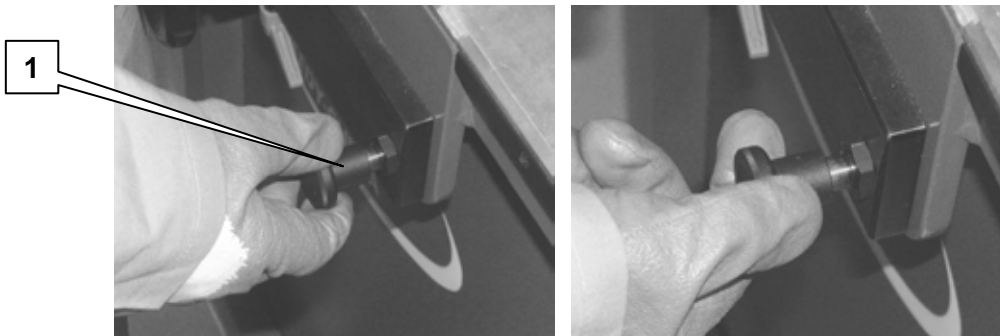


Fig. 4.83 – Pulling out the blocking knob

4. open the catching handle 2 (fig. 4.84);

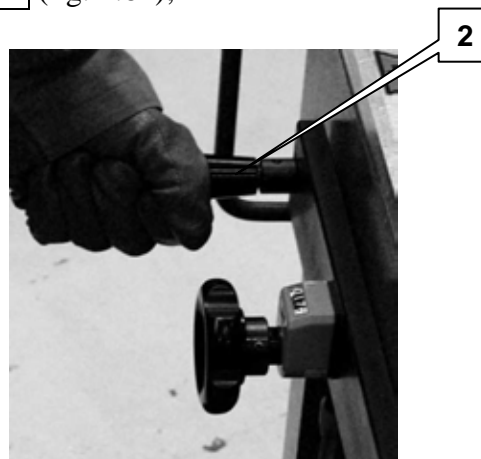


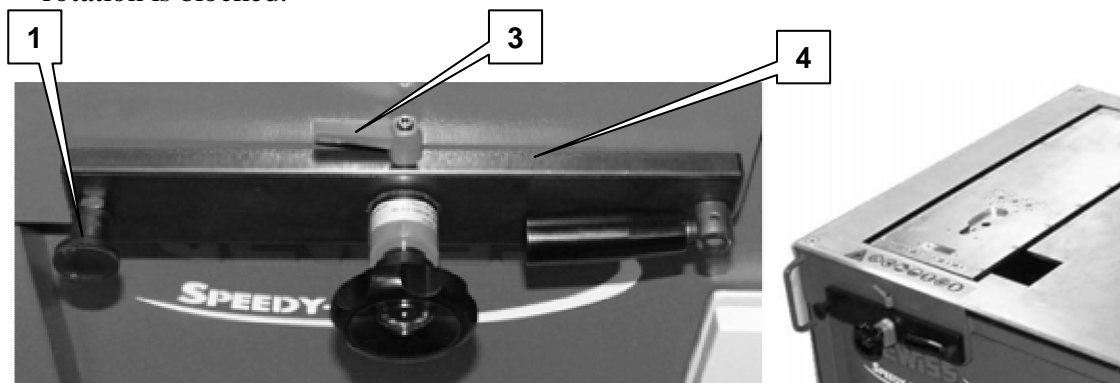
Fig. 4.84 – Opening of catching handle

5. turn clockwise the work station by a 180° angle (fig. 4.85);



*Fig. 4.85 – Rotation of the work station*

6. Clamp the bending station turned towards the inside of the machine by turning the ball grip **1** by 90° (fig. 4.86) and slightly turn the station around the hooking point until the rotation is blocked.



*Fig. 4.86 – Clamping of the bending station*

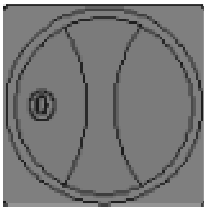


*Always check that the blocking knob is completely inserted.*




*Before carrying out the rotation make sure that the lever **3** is in position with knob blocked and it is parallel to the Bar **4** (fig. 4.86).*

#### 4.3.4 Machine switching off



At the end of bending and/or cutting cycles, to switch off the machine you need only to take the general breaker placed on the main control board (part. **IG** fig. 4.1) in position **0 - OFF**.

This causes the machine switching off.

 Before switching off the machine it is necessary to complete the bending or cutting operation so that the working members of the machine are stopped on a rest position.

#### 4.3.5 Emergency stop of the cycle



To stop machine in case of danger you need only to release the control pedal (part. **3** fig. 4.1) or turn the knob of the main disconnecting switch to position **0-OFF**.

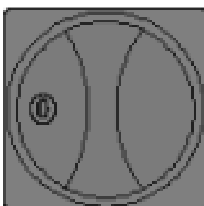
#### 4.3.6 Defaults conduct




In case of defaults, to restore the right working of the machine, operate as follows:



Check that the power plug of the machine is rightly inserted and that the relevant outlet is power with the required voltage.



Try to switch off and switch on again the machine by operating the main breaker/disconnecting switch.

 If the default holds on, notify the Technical Support.

### 4.3.7 Voltage drop

In case of voltage drop the machine immediately stops and it breaks the bending or cutting cycle.

When power returns the machine does not start automatically. To end the bending or cutting cycle it is necessary to press the control pedal.



## ***5.1 Residual risks during maintenance***

### **Present risks:**

- ✓ risks due to crushing, crash of the movable parts of the machine;
- ✓ risks due to crushing, crash in connection with the movable parts inside the machine;
- ✓ risks due to the electric energy presence.

### **Scheduled PPD:**

- ✓ Overalls and safety gloves.



### **Signals:**

- ✓ In front and behind the machine is equipped with special danger and prohibition signals.

### **During the maintenance and adjustment pay attention mainly to the following operations:**

- ✓ Hazards of dragging, entangling or crash of the movable parts accessible inside the machine;
- ✓ Hazards generated by electric energy.

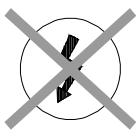
## **5.2 Maintenance data**

Thanks to the intrinsic stoutness and the constructive simplicity of the machine, particularly onerous operations of preventive maintenance are not required. However, in order to guarantee the maximum reliability of the machine and to avoid danger conditions, we suggest You to follow scrupulously the instructions and the warnings stated in these pages and in the special cards of periodic maintenance/check enclosed to this manual.



*For safety reasons, all maintenance operations must be performed by qualified technicians only, with sufficient experience in mechanical and electric field.*

*The attached technicians must also have all due tools to operate in safety.*



*Every kind of operation on electric equipments must be performed only after sectioning the relevant electric system.*

*Lock in position 0 – OFF the general breaker on the electric control panel of the machine using a padlock or other suitable device. If necessary, pull out the power plug from the relevant outlet*



*If it is necessary to disassemble some parts, to operate adequately, we recommend you to reassemble them before restarting the machine.*



*All the materials with environmental impact that need to be eliminated after maintenance operations must be disposed in accordance with regulations in force.*

*If necessary, entrust to skilled structures for their disposal.*



*Make sure that NON authorised personnel does not approach the working zone during the maintenance operations.*

*At the end of whatever operation, verify that no utilised tool is remained on the worktable, near the bending or cutting station.*



*The responsibility of possible damages to things and/or people deriving from the non-observance of the recommendations clearly rests on the attached staff.*

### 5.2.1 General instructions

#### 5.2.1.1 Check of material

With an advance of at least 60 – 70 days regarding the scheduled date for the maintenance operations, carry out a detailed examination of the necessary material:

- ✓ verify if such material is present in the warehouse.
- ✓ eventually request, to the Technical Support, the lacking items, with at least 50 – 60 days in advance.

#### Technical Support:

**GEWISS S.p.A.**

Via A. Volta, 1

24069 CENATE SOTTO (BG) - Italy

*Tel.:* +39 035 94 61 11 (negli orari: 8.30 – 12.30 / 14.00 – 18.00)

*Fax:* +39 035 94 52 22 (24 h)

*e-mail:* gewiss@gewiss.com

*sat:* sat@gewiss.com

*web:* <http://www.gewiss.com>

## 5.3 Operation of ordinary maintenance

For convenience of the staff attached to the maintenance of the machine is here carried out a series of summarising tables, distinct on the basis of the part under maintenance control, of the main operations of ordinary maintenance useful to keep the machine in full working order.



*Whenever arises a malfunctioning and it is not possible to solve the problem, it is mandatory to place the machine out of order and to request the intervention of the Technical Support.*

All said operations are detailed in the following pages.

### Mechanical Parts

**Operation:**

- ✓ Control of bolts and nuts clamping
- ✓ Cleaning and lubrication
- ✓ Greasing of the bending station
- ✓ Control of the metallic parts wearing

**Periodicity:**

- Monthly
- Each shift
- Monthly
- Monthly

### Hydraulic box

**Operation:**

- ✓ Control of the oil level

**Periodicity:**

- Monthly

### Electric system .

**Operation:**

- ✓ Check of cables integrity and connectors clamping
- ✓ Check of control devices and signal lamp functioning
- ✓ Fuses replacement and refit of protection thermal relay


**Periodicity:**

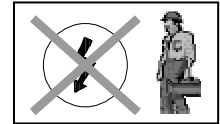
- Six-monthly
- Six-monthly
- At breaking



*All before mentioned checks must be performed before the first setting at work of the machine and after a long stop of the machine itself.*

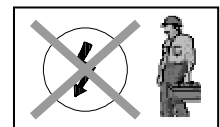
### 5.3.1 Mechanical parts

 *The responsibility of possible damages to things and/or people deriving from improper operations performed by unqualified or unauthorised personnel rests only on such personnel.*



#### 5.3.1.1 Control of bolts and nuts clamping (monthly)

To maintain the machine in full working order it is necessary, **monthly**, to perform a full control of the right clamping of all bolts and nuts and, if necessary, to restore them.



#### 5.3.1.2 Cleaning and lubrication (each shift)

To maintain the machine in full working order, it is necessary to proceed at **the end of each shift** to an accurate cleaning and lubrication of the same one.



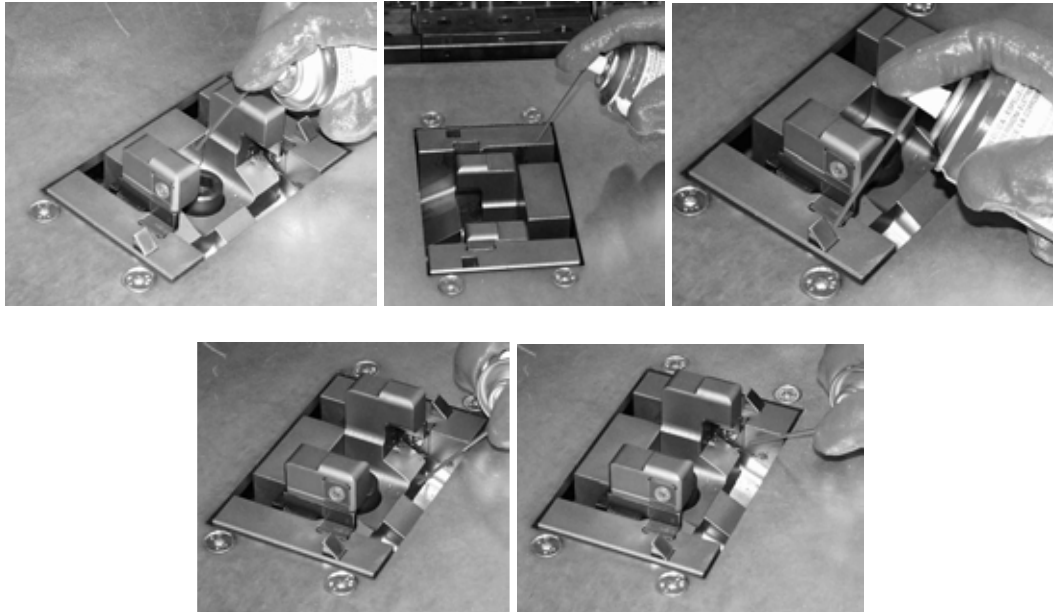
*Always wear gloves and the individual protection means considered suitable also in function of what is indicated on the aerosol oil bomb. Disconnect the electric system before proceeding to the cleaning and lubrication!*

- ✓ Remove carefully the dust and stored up residuals, especially at the bending station **1** and the cutting station **2** (fig. 5.1), using an exhauster.
- ✓ Lubricate the mechanic components of the bending station **1** and cutting station **2** (see next details) (fig. 5.1, fig. 5.2 e fig. 5.3).



Fig. 5.1 – Location of the bending and cutting station.

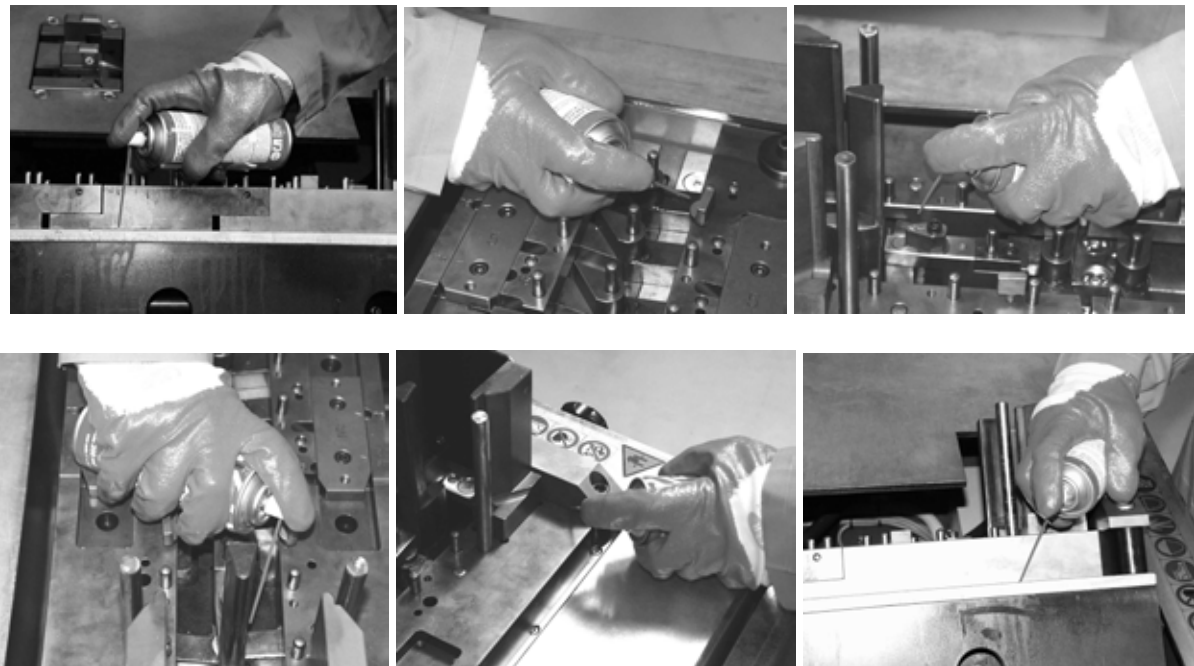
**Details of the lubrication points at the cutting station**



*Fig. 5.2 – Lubrication points at the cutting station*

**Details of the lubrication points at the bending station**

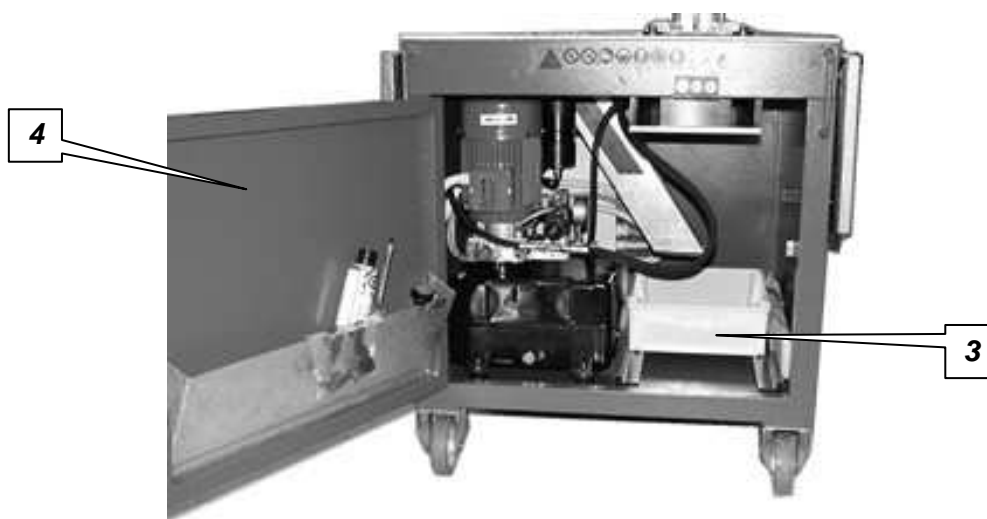




*Fig. 5.3 –Lubrication points at the bending station*

*All the lubrication operations can be performed with the bending station blocked in horizontal position. In the photo of fig. 5.3 the bending station, in some cases, is shown inclined specifically to put in evidence the lubrication point.*

- ✓ Control and eventually empty the box for scraps **3** placed inside the machine and reachable by opening the rear panel **4** of the machine (fig. 5.4). At the end, reposition the tank properly.



*Fig. 5.4 – Box for scraps*

☞ **NEVER** to use gasoline, solvents or other inflammable liquids for cleaning machine.

- ✓ Perform a general cleaning of the electric control panel **5** on board the machine (fig. 5.5); the cleaning, besides saving the panel from degradation, is an excellent means to examine the various components and to identify possible defaults.

The cleaning of the external part can be performed with dry rags to remove dust or with rags moistened with a not aggressive detergent. Inside, usually, it doesn't require cleaning.



Fig. 5.5 – Electric control panel

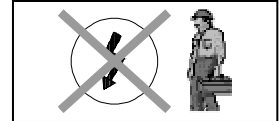
☞ **NEVER** to use, in any case, liquids to clean inside the electric control panel.

☞ **Be always careful, when opening the electric control panel, to the consequent risks of electric shock joined to the high voltage current presence; even dissecting the electric system to the line (without unplugging the power plug) there is voltage to the input to the external line.**

- ✓ Clean the control devices. The cleaning must be performed with a dry rag and a not aggressive detergent.

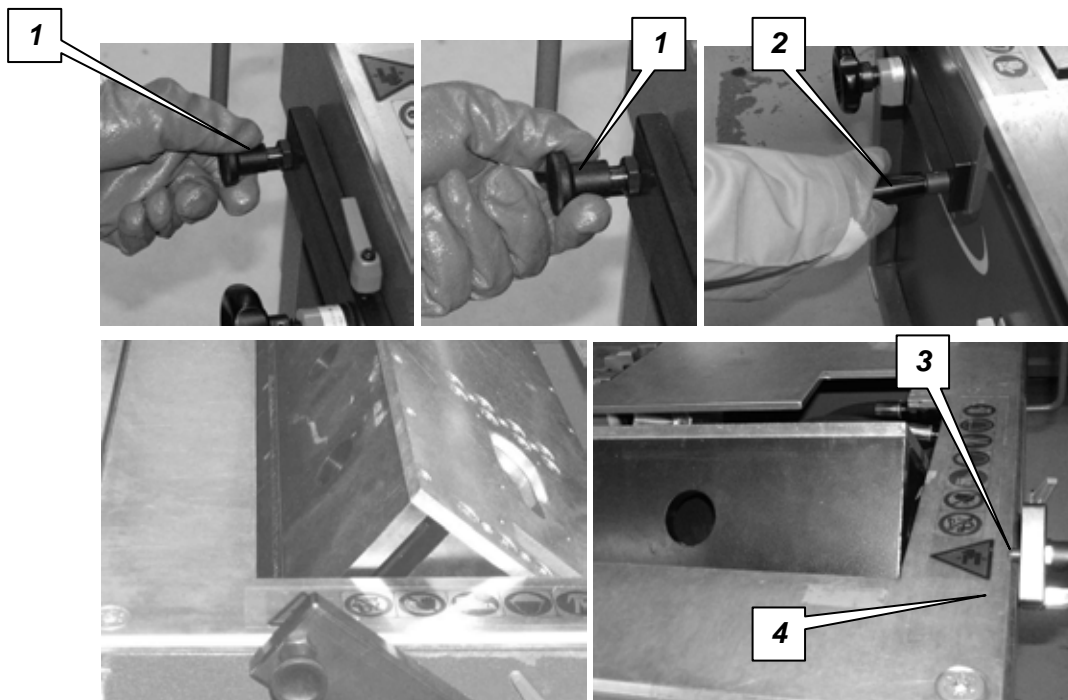


**5.3.1.3 Greasing of bending station (monthly)**



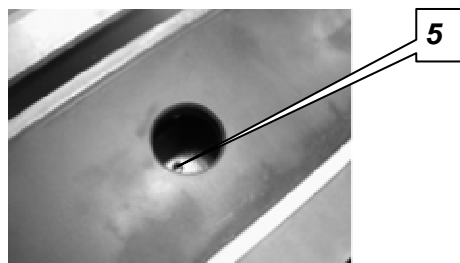
Grease **monthly** the bending station following directions in the present procedures (fig. 5.6):

1. Pull out and rotate 90° the blocking knob **1**;
2. Open the catching handle **2**;
3. Rotate 40° clockwise the bending station and fix it at the position of fig. 5.6 turning 90° the blocking knob, the pivot **3** must lean on the worktable **4**;
4. Check that the knob prevents to the station to go back face down;



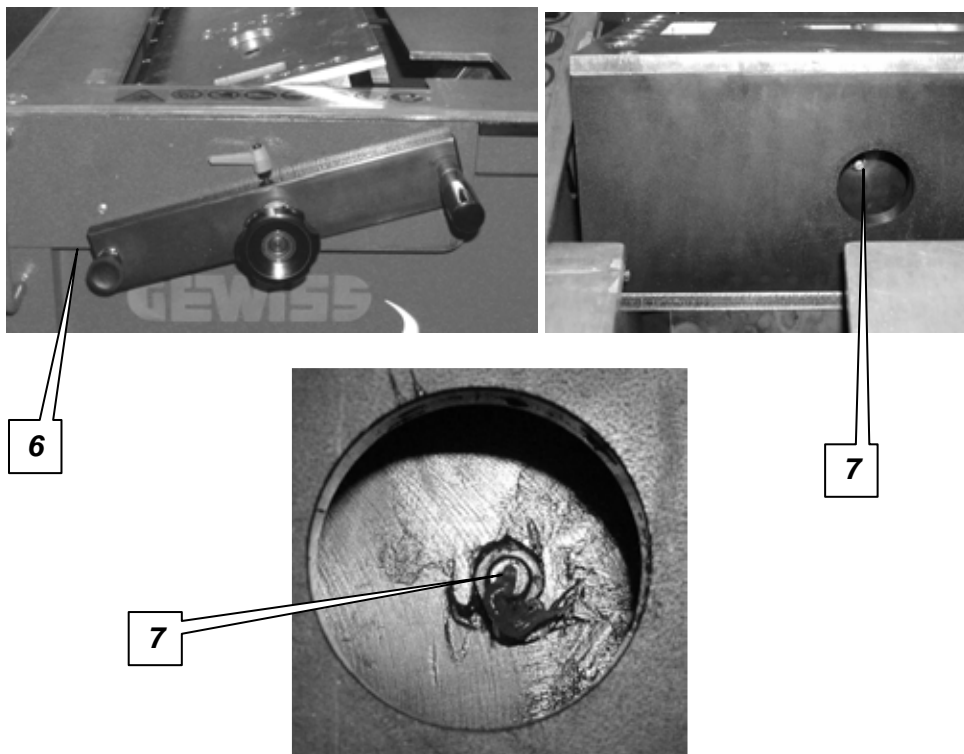
*Fig. 5.6 –Location of the bending station*

5. Grease, by a greaser, point **5** (fig. 5.7);



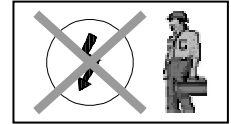
*Fig. 5.7 –Greasing point*

6. Pull out and rotate 90° the blocking knob **1** (fig. 5.6);
7. Rotate counter clockwise moving the station at about 15° as to the surface **4**. The pivot **3** (fig. 5.6) must lean on the worktable **6** (fig. 5.8);
8. Check that the knob prevents the station from going back turned downwards;
9. Grease, by a greaser, point **7** (fig. 5.8);



*Fig. 5.8 – Greasing point*

10. Pull out and rotate 90° the blocking knob **1** (fig. 5.6);
11. Rotate clockwise the station moving it downwards;
12. Put the bending station in position and rotate 90° the block knob **1** (fig. 5.6). Rotate slowly the station around its own hooking point until rotation is blocked **1** (fig. 5.6);
13. Close the catching handle **2** (fig. 5.6).

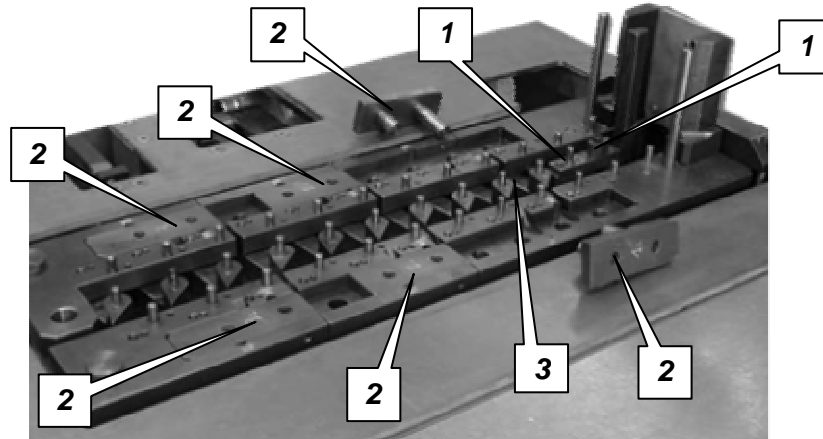


**5.3.1.4 Control of metallic parts wearing (monthly)**

**Monthly** proceed to a careful control of the metallic parts wear state, in order to prevent from risks of sudden breaks.

**Bending station:**

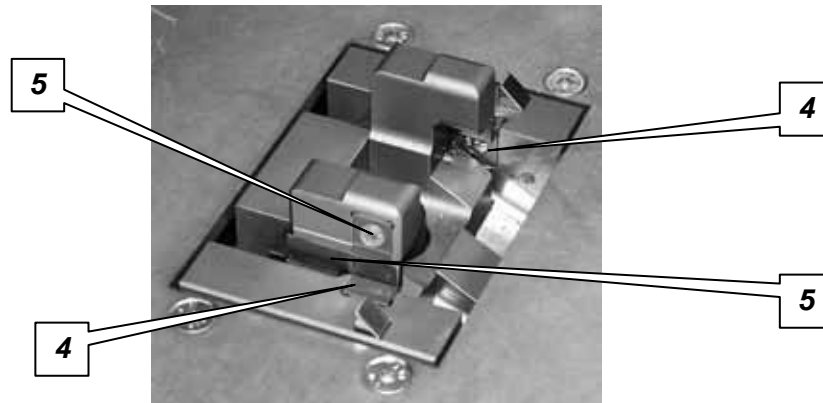
Check the wearing state of pushers **1**, fulcra **2** and metallic parts **3** in general (fig. 5.9).



*Fig. 5.9 – Wear checking – Bending station*

**Cutting station:**

Check wearing of cutting tools **4** and mechanical parts **5** in general (fig. 5.10).

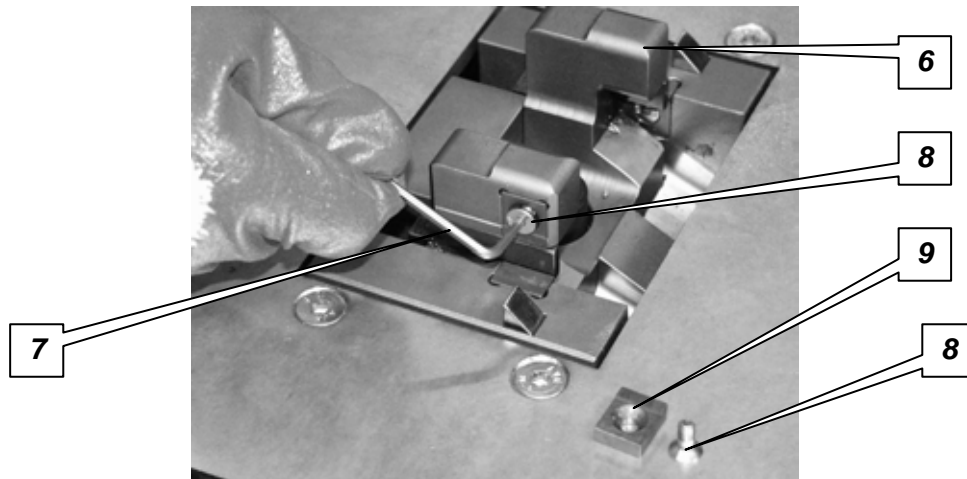


*Fig. 5.10 –Wear checking – Cutting station*

If it is necessary to replace blades, proceed as follows:

**Replacement of the upper blades (fig. 5.11):**

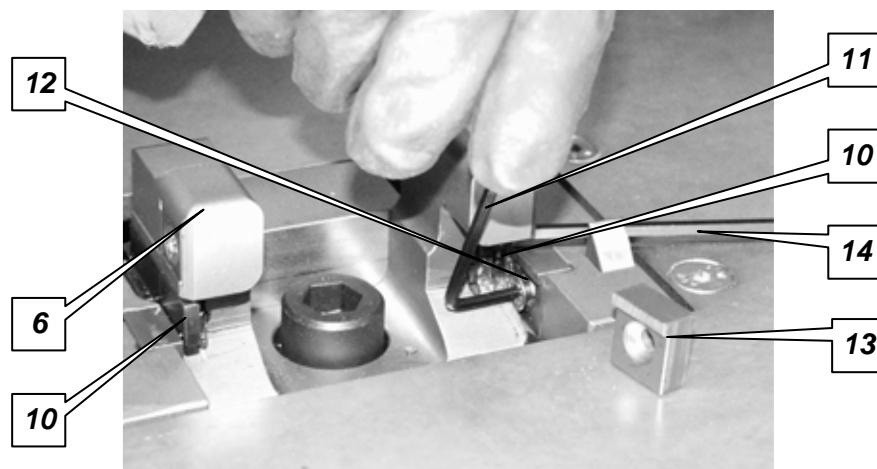
1. Lift the shear **6**;
2. Switch off the machine with the dissecting device **IG** placed on the control panel at position **0-OFF** (see Paragraph 4.2 “Control and signal devices”);
3. Pull the power plug out of the machine;
4. Unscrew by hexagonal wrench **7** (of 3 mm) the screws of the upper blade **8**;
5. Insert a new blade **9**;
6. Replace the second blade as stated in points 4 and 5 of this procedure.



*Fig. 5.11 –Replacement of the upper blades*

**Replacement of the lower blades( Fig.5. 12):**


1. Lift the shear **6**;
2. Switch off the machine with the dissecting device **IG** placed on the control panel at the position **0-OFF** (see Paragraph 4.2 “Control and signal devices”);
3. Pull the power plug out of the machine;
4. By a screwdriver **14** move back the screen **10**;
5. Unscrew by hexagonal wrench **11** (of 3 mm) the screws of the lower blade **12**;
6. Insert the new blade **13**;
7. Replace the second blade as stated at points 4÷6 of this procedure.

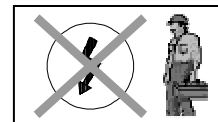


*Fig. 5.12 –Replacement of lower blades*

 **To order a set of blades contact the Technical Support Service with reference to the code MV 51945**

### 5.3.2 Hydraulic box

 *The responsibility of any damages to things and/or people resulting from improper operations performed by unqualified or unauthorised personnel rests only on such personnel .*



#### 5.3.2.1 Control of the oil level (Monthly)

**Monthly** proceed to a control of oil level in the Hydraulic box.

To perform the control of the oil level proceed as follows (fig. 5.13):

1. open the rear panel **1** by the proper hexagonal wrench;
2. unscrew the oil plug **2** of the Hydraulic box **3**;
3. check on the oil dip stick, integral with the oil plug, that the oil level is included between the upper notch and the lower notch;
4. if necessary fill using oil H-LP 46;
5. screw again the oil plug **2**;
6. close the rear panel **1** by the proper hexagonal wrench.

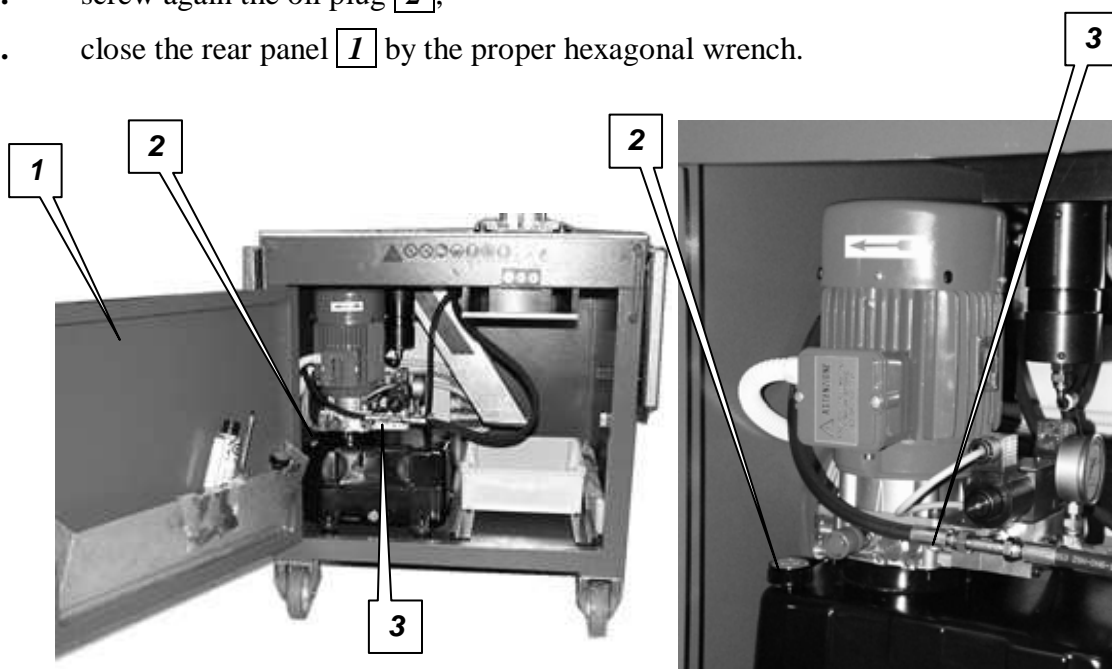



Fig. 5.13 – Check of the oil level in the Hydraulic box

 *Remember that the oil is an element at high environment impact. Proceed then to its storage and disposal according to the regulations in force in the country of the machine user.*

### 5.3.3 Electrical system

To maintain the machine in full working order, it is necessary to perform regularly and at specified intervals the following maintenance operations of the electrical system.:



*All direct operations on the electrical equipment must be performed **EXCLUSIVELY** by qualified and authorised personnel, after dissecting the electric system of the machine.*

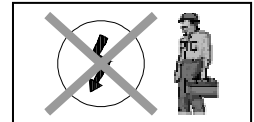


*Lock in position 0 – OFF the general breaker on the electric panel of the machine using a padlock or other suitable device. If necessary, pull out the power plug from the relevant outlet.*



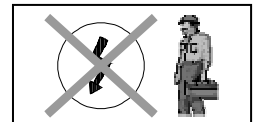
*The responsibility of any damages to things and/or people deriving from improper interventions performed by unqualified or unauthorised personnel rests only on such personnel.*

#### 5.3.3.1 Check of cables integrity and connectors fixing (six-monthly)



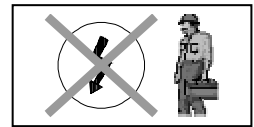
**Six-monthly**, proceed to a careful check of the various cables integrity and of the right connectors and terminals clamping .

#### 5.3.3.2 Check of functioning of control devices and signal lamp (six-monthly)



**Six-monthly**, check functioning of the control devices and the signal lamp of electric current presence . If necessary, replace the lamp.

**5.3.3.3 Fuses replacement and refit of protection thermal relay (at breaking)**

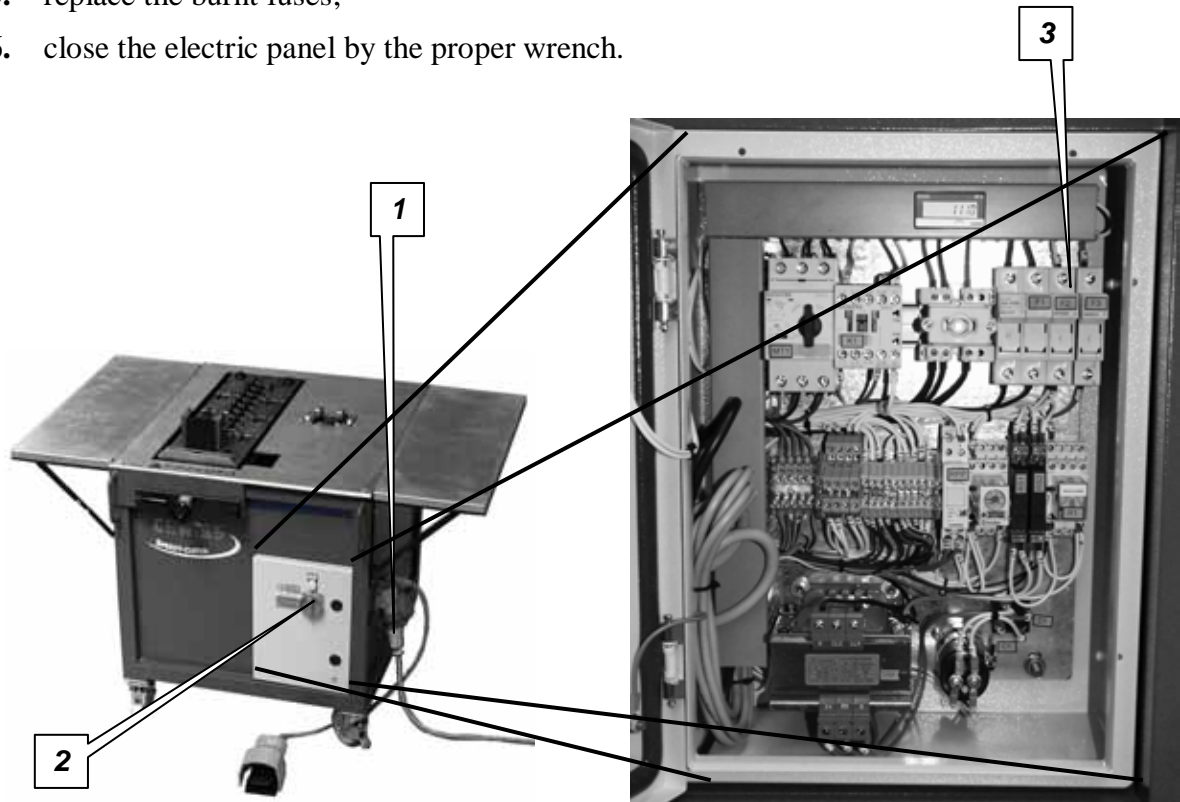


Any drop of voltage, short circuit or overload may cause the replacement of fuses or the refit of the thermal relay for the electric motor protection.

**Fuses replacement (fig. 5.14)**

To replace the fuses proceed as follows:

1. unplug the power plug **1** of the machine;
2. dissect the machine taking the breaker **2** to the position **0 – OFF**;
3. open the electric panel by the proper wrench;
4. pull out the fuses **3**;
5. replace the burnt fuses;
6. close the electric panel by the proper wrench.



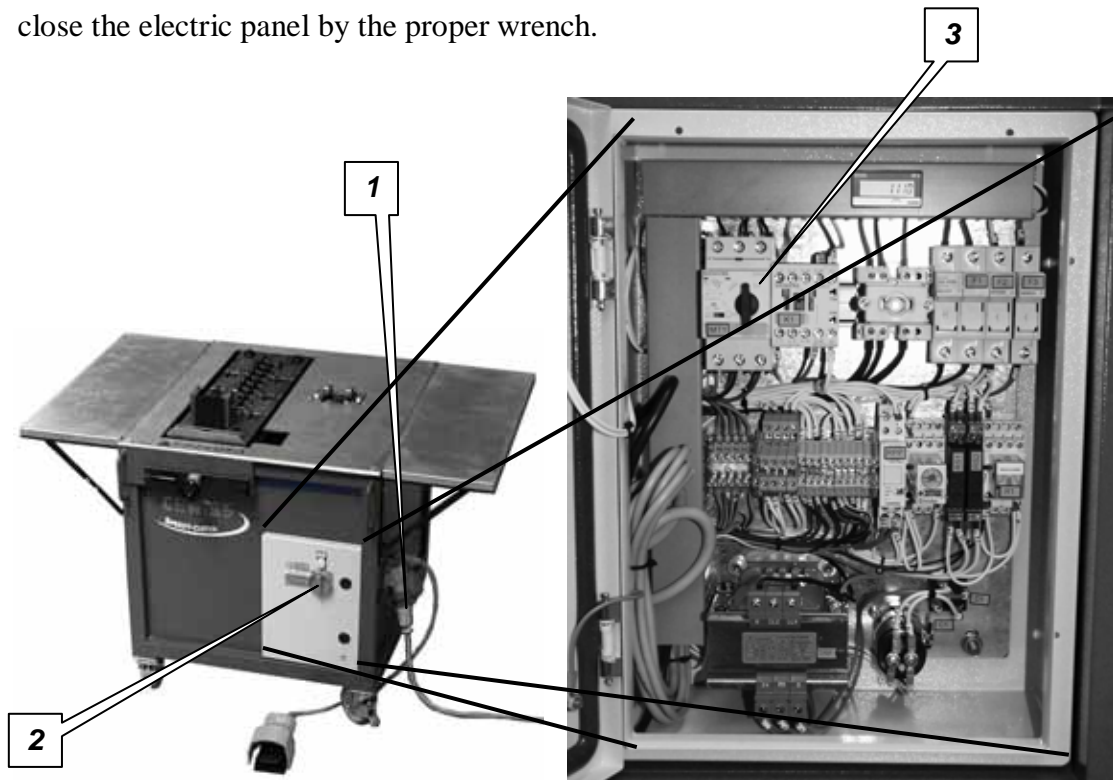
*Fig. 5.14 Fuses replacement*



**Refit of the protection thermal relay (fig. 5.15)**

To restore the protection thermal relay of the electric motor proceed as follows:

1. unplug the power plug **1** of the machine;
2. dissect the machine taking the breaker **2** to the position **0 – OFF**;
3. open the electric panel by the proper wrench;
4. rotate the knob **3** of the thermal relay on **I**;
5. close the electric panel by the proper wrench.




*Fig. 5.15 –Refit of the thermal relay for motor protection*

## 5.4 Extraordinary maintenance operations

If said machine needs extraordinary maintenance operations/ not scheduled /modifications it is possible to contact the Technical Support notifying the following data:

- Type and model of the machine;
- Serial number of the machine;
- Year of manufacture of the machine;
- Functional unit involved in the problem;
- Type of default found;
- Description of the requested modifications.

 *The responsibility of any damages to things and/or people deriving from improper operations performed by unqualified or unauthorised personnel rests clearly on such personnel.*



### 5.4.1 Bending station setting

To calibrate the bending station proceed as follows:

1. lift the bending station;
2. arrange the station with fulcra 3 in position T3, 4 in T4 and 5 in T5;
3. rotate lever **1** to free the rotation of the knob **2** (fig. 5.16);
4. rotate knob **2** to set on indicator **3** the number 200 (fig. 5.16);

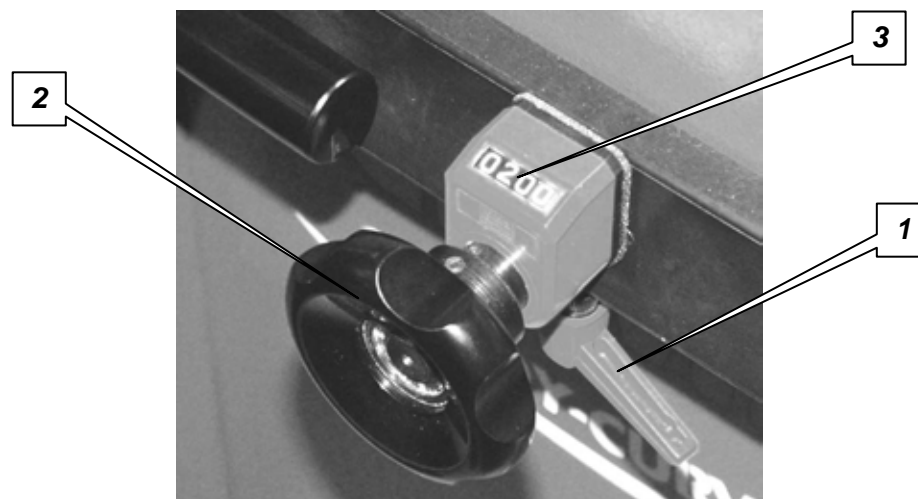
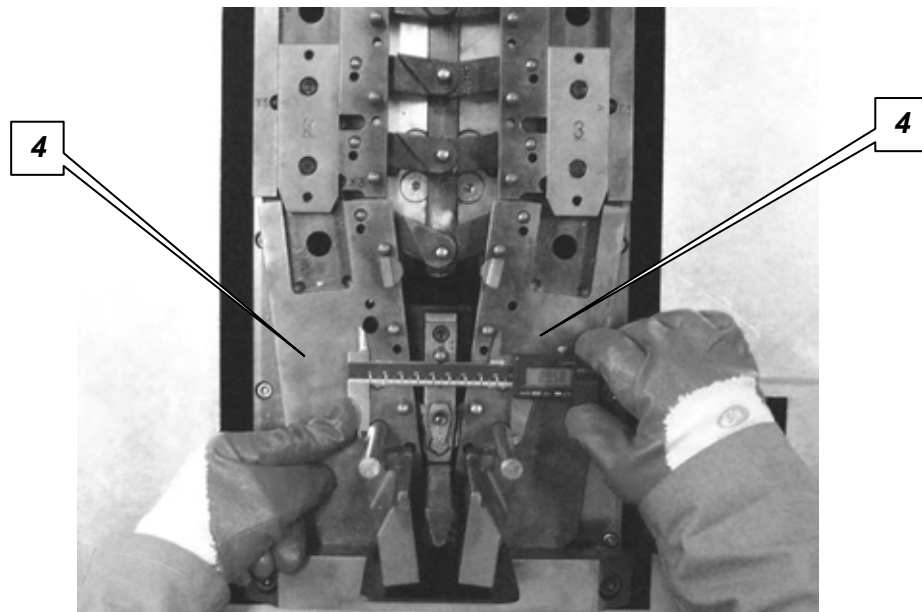


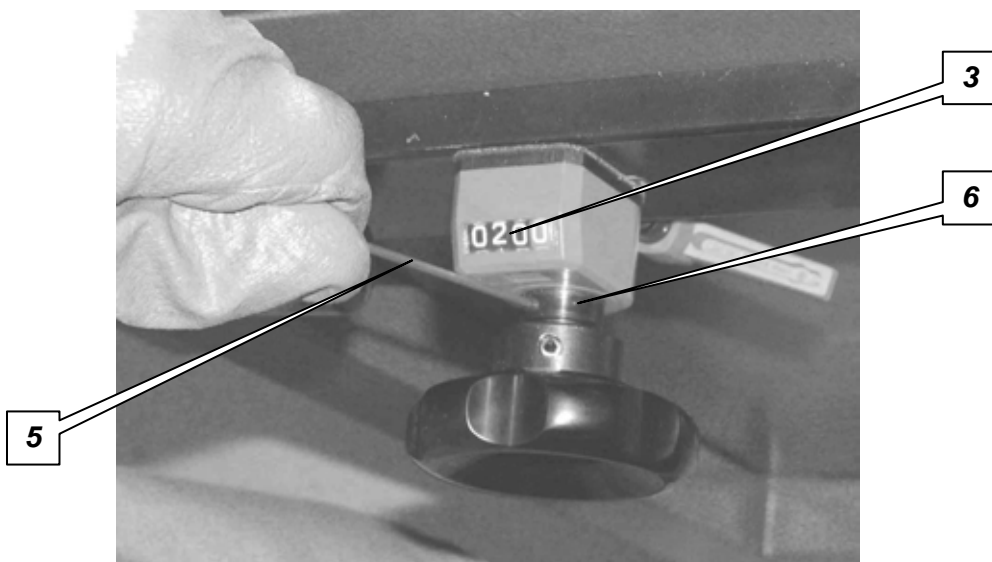
Fig. 5.16 –Setting of the indicator

5. Press, with Your foot, the pedal closing the arms **4** (fig. 5.17) and measure the opening of the pivots holding the pedal operated. If the measured opening is equal to 89,6 mm the station doesn't need setting; on the contrary see point 6;



*Fig. 5.17 – Arms closing*

6. Open and close the arms **4** by rotating the knob **2** up to get the opening of the pivots for 89,6 mm (fig. 5.17 and fig. 5.16);
7. lock the rotation of the knob **2** by rotating the lever **1** (fig. 5.16);
8. unlock the grub by a 2mm hexagonal wrench **5** (not on issue) (fig. 5.18);



*Fig. 5.18 –Arms closing*

9. rotate the bush **6** of the indicator **3**, by the hexagonal wrench **5**, up to the indication of the number 200 (fig. 5.18);
10. lock the grub by a 2mm hexagonal wrench **5** (not on issue) (fig. 5.18).

## ***5.5 Disassembly and demolition***



### **5.5.1 Disassembly of the machine**

If it is necessary to disassemble the machine, carry out the following procedure:

- ☞ *The responsibility of any damages to things and/or people deriving from improper operations performed by unqualified or unauthorised personnel (or by the non observance of recommendations ) rests only on such personnel.*
- ✓ dissect the machine rotating the breaker, placed on the control panel, to the position **0 - OFF**.
  - ✓ unplug the power plug.
  - ✓ proceed to the disassembly of the machine. We suggest You to contact the Technical Support to get the necessary service during such operation.
  - ✓ If it is necessary to handle the machine, operate according to the instructions carried out in Paragraph 3.5 “*Unpacking, lifting and transport*” in Chapter 3 – “*Installation and connection*”.

### **5.5.2 Demolition**

When the machine has reached its own end life, before proceeding to its final dismantling, it is necessary to do a series of operations to minimise the environmental impact connected to the disposal of the machine components, in accordance with regulations in force on waste disposal.

Such operations are:

- ✓ *Recovery and disposal of oils.*  
Unload the oil of the Hydraulic box, and gather it in suitable boxes. Stock the recovered oil in a tank then dispose it by special structures (*Obligatory Union of the burnt oils*).
- ✓ *Separation and storage of the parts at environmental impact.*  
Separate those parts which may cause pollution and send them to a differentiated disposal, making a selection of the materials to promote their recycling. Such parts are constituted by details in plastic or rubber, electric cables and electric components.
- ✓ *Casing Disposal.*  
At the end of the removal and storage of the polluting elements, entrust skilled structures of the casing disposal.




*On demolition of the machine, make useless its identification plate and the relevant technical documents. It is faculty of the user to give back such elements to technical offices of the Manufacturer that will provide for their destruction.*

*It is not allowed a simple storage, in an inaccessible place, of the machine plate and its technical documents.*

*At the end of the operations, notify the Manufacturer of the occurred dismantling of the machine.*

## **5.6 Annexes**

Here follows the collection of a series of supplementary information concerning the usage and setting of the machine.

 *The responsibility for any damages to things and/or people resulting from improper operations performed by unqualified personnel does not rest on the Manufacturer.*

**Annex 1 – Bending parameters**

**Annex 2 – Wiring diagram**

**Annex 3 – Hydraulic diagram**

**Annex 4 – Bending station**

**Annex 5 – Cutting station**

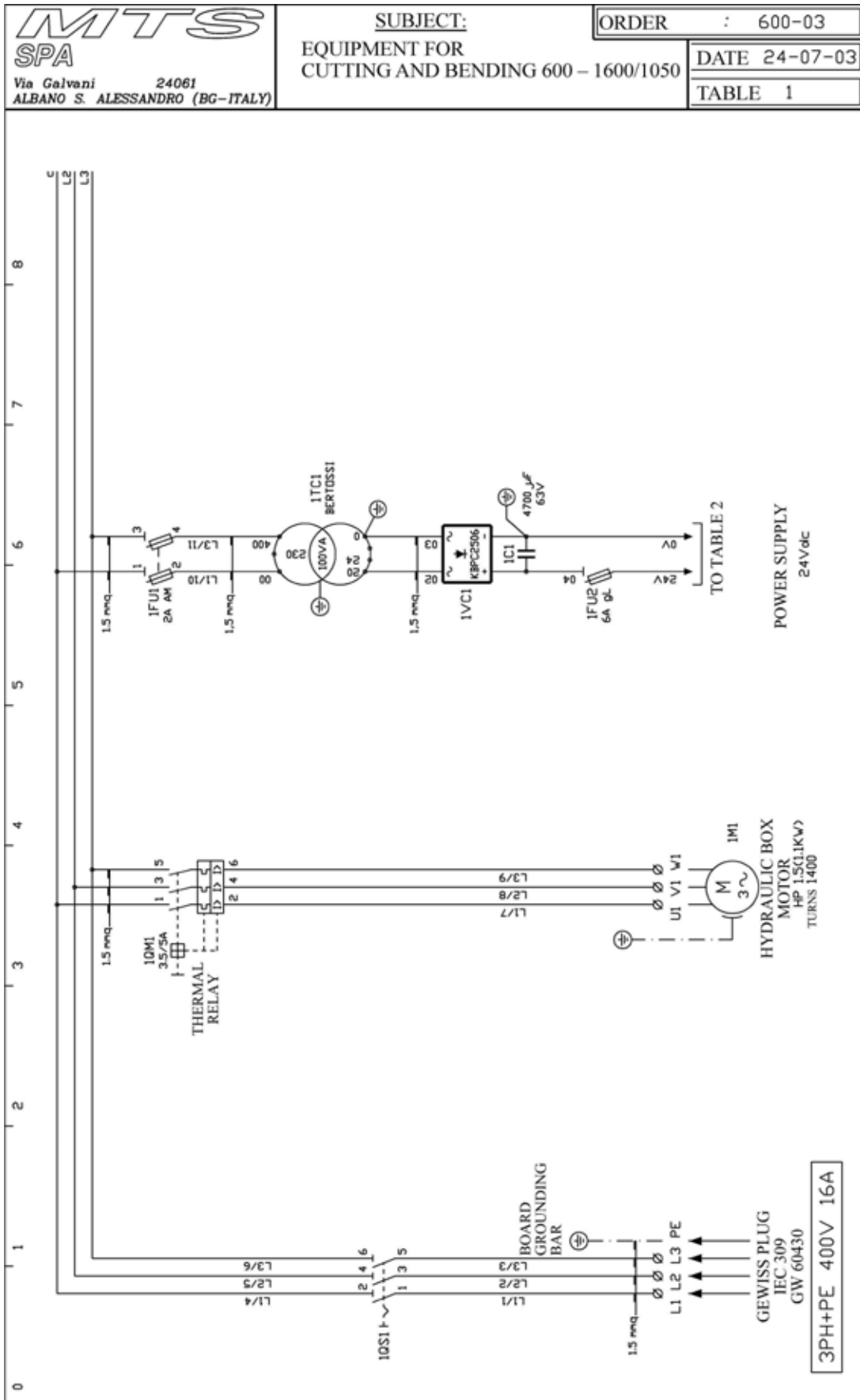
Gangway				Bending angle	Pushers position		Fulcra position			Indicator (*)	Minimum length of gangway to be cut	N. bends	Diagram	
Finishing Type	Code	Width B	Height		I	II	3	4	5				I1 x I2	R
BFR 30 EZ	MV 50420	50	30	45°			T3	T4	T5	231	600	2	540 x 260	230
				90°			T3	T4	T5	231	800	4	460	230
	MV 50421	100	30	45°			T3	T4	T5	216	700	3	620 x 340	330
				90°			T3	T4	T5	206	900	5	530	270
	MV 50422	150	30	45°			T3	T4	T5	214	800	4	700 x 440	430
				90°			T3	T4	T5	201	1100	7	660	385
MV 50423	200	30	45°			X3	T4	T5	169	900	5	790 x 480	530	
			90°			X3	T4	T5	163	1300	9	780	480	
MV 50425	300	30	45°			X3	X4	T5	154	1100	7	950 x 630	730	
			90°			X3	X4	T5	150	1700	13	1040	670	
BFR 30 GAC	MV 50220	50	30	45°			T3	T4	T5	231	600	2	540 x 260	230
				90°			T3	T4	T5	231	800	4	460	230
	MV 50221	100	30	45°			T3	T4	T5	216	700	3	620 x 340	330
				90°			T3	T4	T5	206	900	5	530	270
	MV 50222	150	30	45°			T3	T4	T5	214	800	4	700 x 440	430
				90°			T3	T4	T5	201	1100	7	660	385
MV 50223	200	30	45°			X3	T4	T5	176	900	5	790 x 480	530	
			90°			X3	T4	T5	171	1300	9	780	480	
MV 50225	300	30	45°			X3	X4	T5	163	1100	7	960 x 630	740	
			90°			X3	X4	T5	158	1700	13	1040	670	
BF 30 INOX	MV 50620	50	30	45°			T3	T4	T5	229	800	4	540 x 260	230
				90°			T3	T4	T5	229	1100	7	460	230
	MV 50621	100	30	45°			T3	T4	T5	216	700	3	620 x 340	330
				90°			T3	T4	T5	206	900	5	530	270
	MV 50622	150	30	45°			T3	T4	T5	211	900	4	700 x 440	430
				90°			T3	T4	T5	200	1300	7	660	385
MV 50623	200	30	45°			X3	T4	T5	166	900	5	790 x 480	530	
			90°			X3	T4	T5	169	1300	9	780	480	
MV 50625	300	30	45°			X3	X4	T5	149	1100	7	960 x 630	740	
			90°			X3	X4	T5	144	1700	13	1020	670	
BFR 60 Z100	MV 50530	50	60	45°			T3	T4	T5	223	600	2	540 x 260	230
				90°			T3	T4	T5	220	800	4	460	230
	MV 50531	100	60	45°			T3	T4	T5	216	700	3	620 x 340	330
				90°			T3	T4	T5	206	900	5	530	270
	MV 50532	150	60	45°			T3	T4	T5	200	800	4	700 x 440	430
				90°			T3	T4	T5	191	1100	7	660	385
	MV 50533	200	60	45°			X3	T4	T5	166	900	5	790 x 480	530
				90°			X3	T4	T5	163	1300	9	780	480
	MV 50535	300	60	45°			X3	X4	T5	155	1100	7	960 x 630	740
				90°			X3	X4	T5	150	1700	13	1030	670
MV 50536	400	60	45°			X3	X4	T5	148	1300	9	1150 x 780	960	
			90°			X3	X4	T5	152	2200	18	1360	960	
MV 50537	500	60	45°			R - L			144	1600	12	1440 x 950	1270	
			90°			R - L			144	2800	24	1730	1270	
MV 50538	600	60	45°			R - L			129	1700	13	1110 x 1520	1370	
			90°			R - L			129	3000	26	1870	1370	
BFR 60 EZ	MV 50430	50	60	45°			T3	T4	T5	223	600	2	540 x 260	230
				90°			T3	T4	T5	220	800	4	460	230
	MV 50431	100	60	45°			T3	T4	T5	216	700	3	620 x 340	330
				90°			T3	T4	T5	210	900	5	530	270
	MV 50432	150	60	45°			T3	T4	T5	204	800	4	700 x 440	430
				90°			T3	T4	T5	200	1100	7	660	385
	MV 50433	200	60	45°			X3	T4	T5	167	900	5	790 x 480	530
				90°			X3	T4	T5	161	1300	9	780	480
	MV 50435	300	60	45°			X3	X4	T5	154	1100	7	960 x 630	740
				90°			X3	X4	T5	148	1700	13	1030	670
	MV 50436	400	60	45°			X3	X4	T5	145	1300	9	1150 x 780	960
				90°			X3	X4	T5	148	2200	18	1360	960
	MV 50437	500	60	45°			R - L			141	1600	12	1440 x 950	1270
				90°			R - L			141	2800	24	1730	1270
MV 50438	600	60	45°			R - L			129	1700	13	1110 x 1520	1370	
			90°			R - L			129	3000	26	1870	1370	

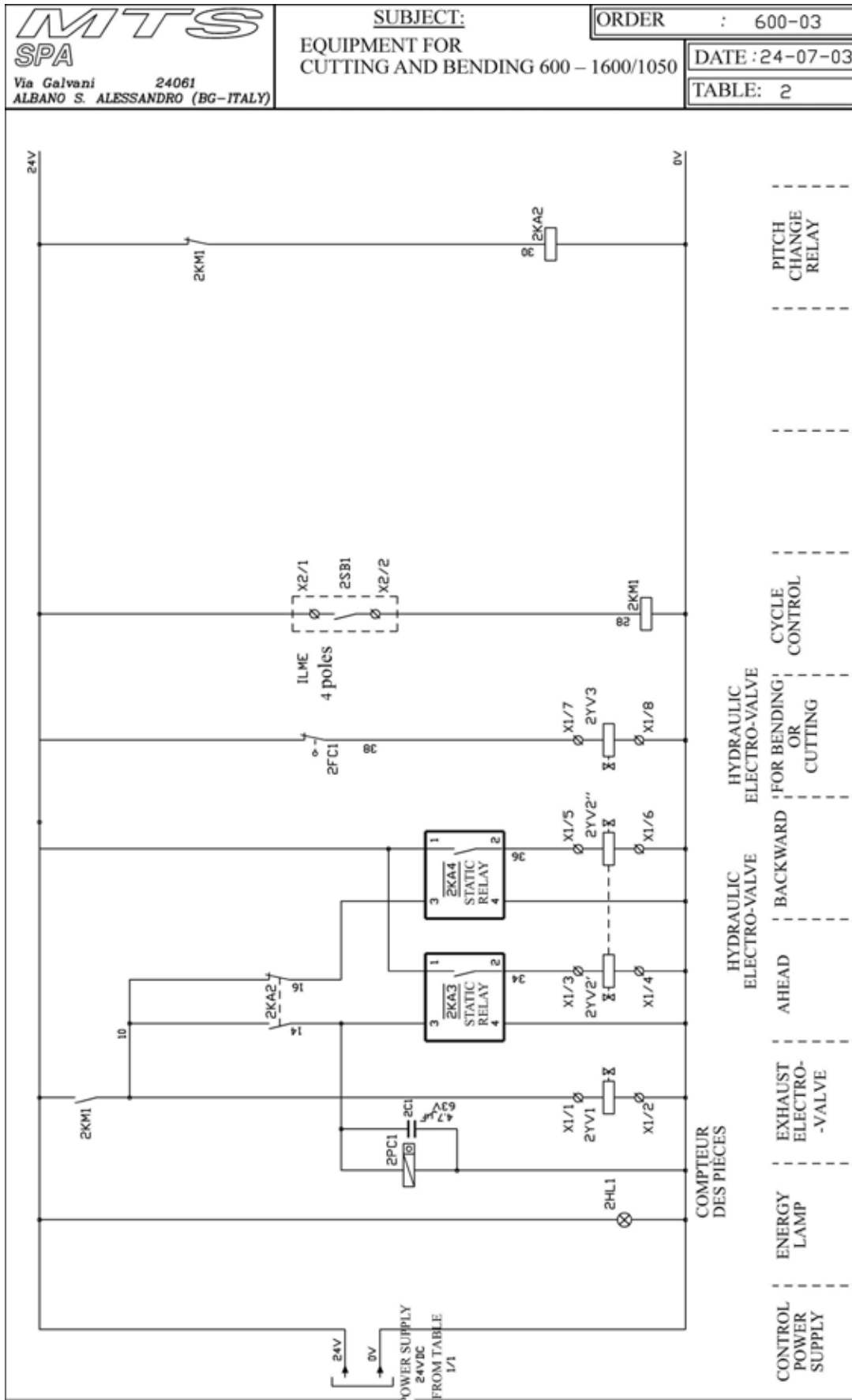
(\*) The indicator is a reference value; it must be optimised during the bending phase; never use values lower than the ones recommended.. Read carefully the manual before operating.


Gangway				Bending angle	Pushers position		Fulcra position			Indicator (*)	Minimum length of gangway to be cut	N. bends	Diagram	
Finishing Type	Code	Width B	Height		I	II	3	4	5				I1 x I2	R
				BFR 60 GAC	MV 50230	50	60	45°			T3	T4	T5	223
90°			T3					T4	T5	220	800	4	460	230
MV 50231	100	60	45°				T3	T4	T5	216	700	3	620 x 340	330
			90°				T3	T4	T5	201	900	5	530	270
MV 50232	150	60	45°				T3	T4	T5	214	800	4	700 x 440	430
			90°				T3	T4	T5	203	1100	7	660	385
MV 50233	200	60	45°				X3	T4	T5	168	900	5	790 x 480	530
			90°				X3	T4	T5	168	1300	9	780	480
MV 50235	300	60	45°				X3	X4	T5	155	1100	7	960 x 630	740
			90°				X3	X4	T5	150	1700	13	1030	670
MV 50236	400	60	45°				X3	X4	T5	148	1300	9	1150 x 780	960
			90°				X3	X4	T5	152	2200	18	1360	960
MV 50237	500	60	45°			R - L			144	1600	12	1440 x 950	1270	
			90°			R - L			144	2800	24	1730	1270	
MV 50237	600	60	45°			R - L			129	1700	13	1110 x 1520	1370	
			90°			R - L			129	3000	26	1870	1370	
BF 56 INOX	MV 50630	50	56	45°			T3	T4	T5	206	600	2	540 x 260	230
				90°			T3	T4	T5	206	800	4	460	230
	MV 50631	100	56	45°			T3	T4	T5	209	700	3	620 x 340	330
				90°			T3	T4	T5	199	900	5	530	270
	MV 50632	150	56	45°			T3	T4	T5	204	800	4	700 x 440	430
				90°			T3	T4	T5	196	1100	7	660	385
	MV 50633	200	56	45°			X3	T4	T5	168	900	5	790 x 480	530
				90°			X3	T4	T5	160	1300	9	780	480
	MV 50635	300	56	45°			X3	X4	T5	148	1100	7	960 x 630	740
				90°			X3	X4	T5	143	1700	13	1030	670
	MV 50636	400	56	45°			X3	X4	X5	139	1300	9	1150 x 780	950
				90°			X3	X4	X5	139	2200	18	1370	960
MV 50637	500	56	45°			R - L			134	1600	12	1440 x 950	1270	
			90°			R - L			134	2800	24	1730	1270	
BFR 110 Z100	MV 50542	150	110	45°			T3	T4	T5	206	800	4	710 x 410	440
				90°			T3	T4	T5	198	1100	7	660	385
	MV 50543	200	110	45°			X3	T4	T5	169	900	5	790 x 490	530
				90°			X3	T4	T5	172	1400	10	850	540
	MV 50545	300	110	45°			X3	T4	T5	154	1100	7	960 x 660	740
				90°			X3	T4	T5	150	1700	13	1030	670
MV 50546	400	110	45°			X3	X4	T5	141	1300	9	1150 x 780	960	
			90°			X3	X4	T5	141	2200	18	1370	960	
MV 50547	500	110	45°			R - L			142	1600	12	1420 x 960	1270	
			90°			R - L			142	2800	24	1730	1270	
BFR 110 EZ	MV 50442	150	110	45°			T3	T4	T5	211	800	4	710 x 410	440
				90°			T3	T4	T5	202	1100	7	660	385
	MV 50443	200	110	45°			X3	T4	T5	165	900	5	790 x 490	530
				90°			X3	T4	T5	167	1400	10	850	540
	MV 50445	300	110	45°			X3	T4	T5	146	1100	7	960 x 660	740
				90°			X3	T4	T5	141	1700	13	1030	670
MV 50446	400	110	45°			X3	X4	T5	138	1300	9	1150 x 780	960	
			90°			X3	X4	T5	138	2200	18	1370	960	
MV 50447	500	110	45°			R - L			140	1600	12	1420 x 960	1270	
			90°			R - L			140	2800	24	1730	1270	
BFR 110 GAC	MV 50242	150	110	45°			T3	T4	T5	214	800	4	710 x 410	440
				90°			T3	T4	T5	204	1100	7	660	385
	MV 50243	200	110	45°			X3	T4	T5	171	900	5	790 x 490	530
				90°			X3	T4	T5	171	1400	10	850	540
	MV 50245	300	110	45°			X3	T4	T5	152	1100	7	960 x 660	740
				90°			X3	T4	T5	148	1700	13	1030	670
MV 50246	400	110	45°			X3	X4	T5	141	1300	9	1150 x 780	960	
			90°			X3	X4	T5	141	2200	18	1370	960	
MV 50247	500	110	45°			R - L			140	1600	12	1420 x 960	1270	
			90°			R - L			140	2800	24	1730	1270	

(\*) The indicator is a reference value; it must be optimised during the bending phase; never use values lower than the ones recommended. Read carefully the manual before operating.

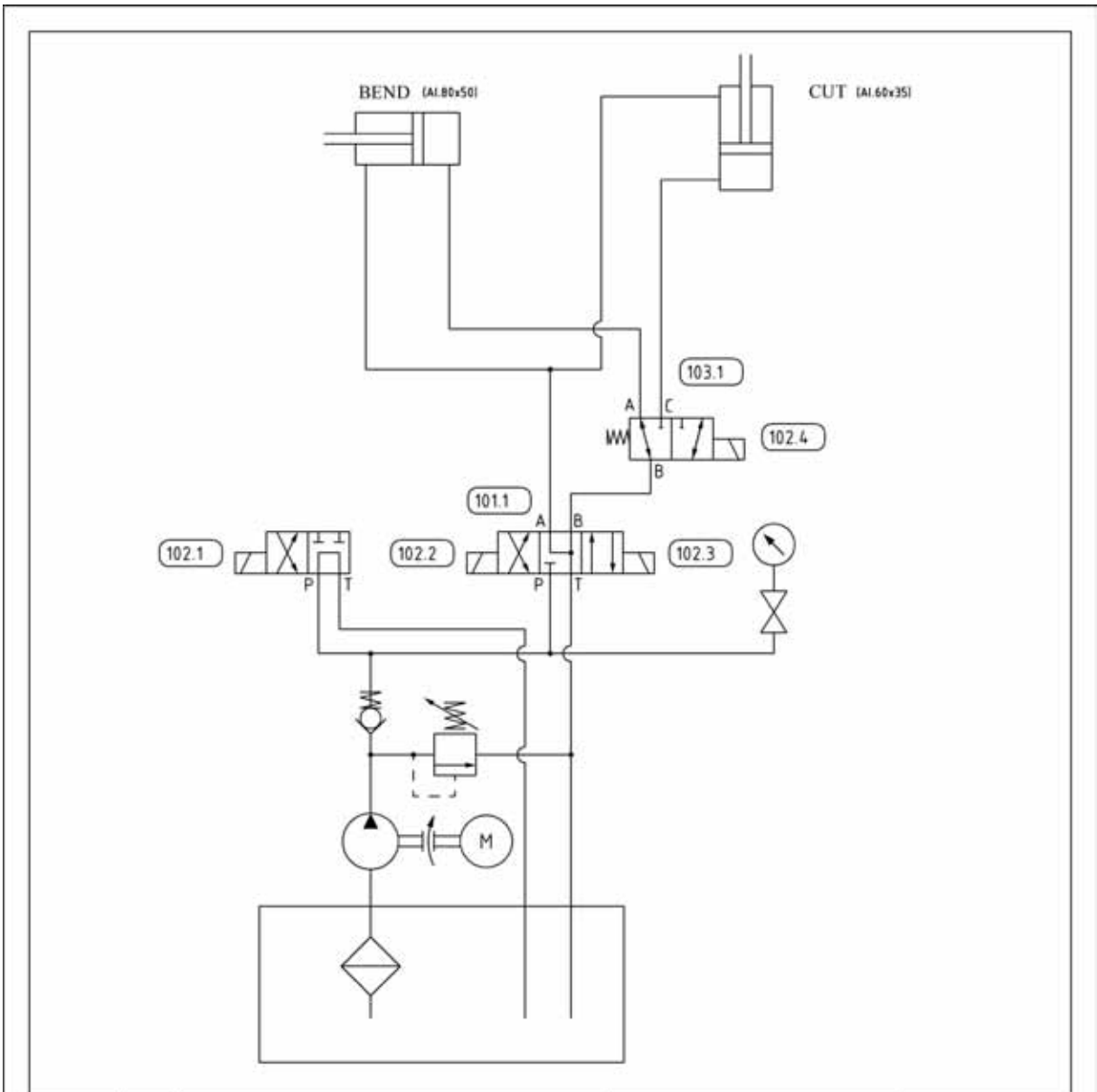






 M.T.S. S.p.A. Via Galvani, sn. Albano S.Alessandro (BG) - ITALY		LIST OF MATERIALS FOR: SPEEDY CURVA 600-1006/1050			Date: 08/09/2003
ANNEX N°2 Page 1/2		ELECTRIC MATERIAL			
REF.	Material denomination	Manufacturer	Code	U.M.	Q.ty
	Wall-type proof fixed 90° plug 16A 3P+T	GEWISS	GW60430	Nr.	1
1QS1	Rotative breaker for locking door 16A 3P	GEWISS	GW70002	Nr.	1
1FU2	Dissectable fuse holder 1P 32A 10.3x38 MOD	GEWISS	GW96205	Nr.	2
1FU1	Dissectable fuse holder 2P 32A 10.3x38 400V	GEWISS	GW96302	Nr.	1
1FU1	Fuses GG 10.3x38 500V 2A	GEWISS	GW72104	Nr.	2
1FU2	Fuses GG 10.3x38 500V 6A	GEWISS	GW72105	Nr.	1
2HL1	Bright white indicator	GEWISS	GW74155	Nr.	1
2HL1	Incandescent lamp 30V BA9S	GEWISS	GW74216	Nr.	1
2FC1	Miniature limit switch	TELEMECANIQUE	TEXCMA1022	Nr.	1
2KA2	Pitch-pitch relay 1NA-1NC 16A 24V	GEWISS	GW96659	Nr.	1
2SB1	Simple plastic pedals, normal protection 1 breaker	TER	TPNF18620010	Nr.	1
X2	4 poles embedding box	ILME	ILCK031	Nr.	1
X2	3 poles vertical moving box	ILME	ILCK03V	Nr.	1
X2	10 A 4 poles outlet element	ILME	ILCKF03	Nr.	1
X2	10 A 4 poles plug element	ILME	ILCKM03	Nr.	1
1VC1	Diode monophasic bridge 35A 1200V	IOR	IR36MB120A	Nr.	1
1C1	Electrolytic rectifying condenser 4700µF 63V screw (F35) 35x60	KENDEIL	PCERX4700-63	Nr.	1
2C1	Electrolytic rectifying condenser 4.7µF 100V 5x11	KENDEIL	PCER4M7-100	Nr.	1

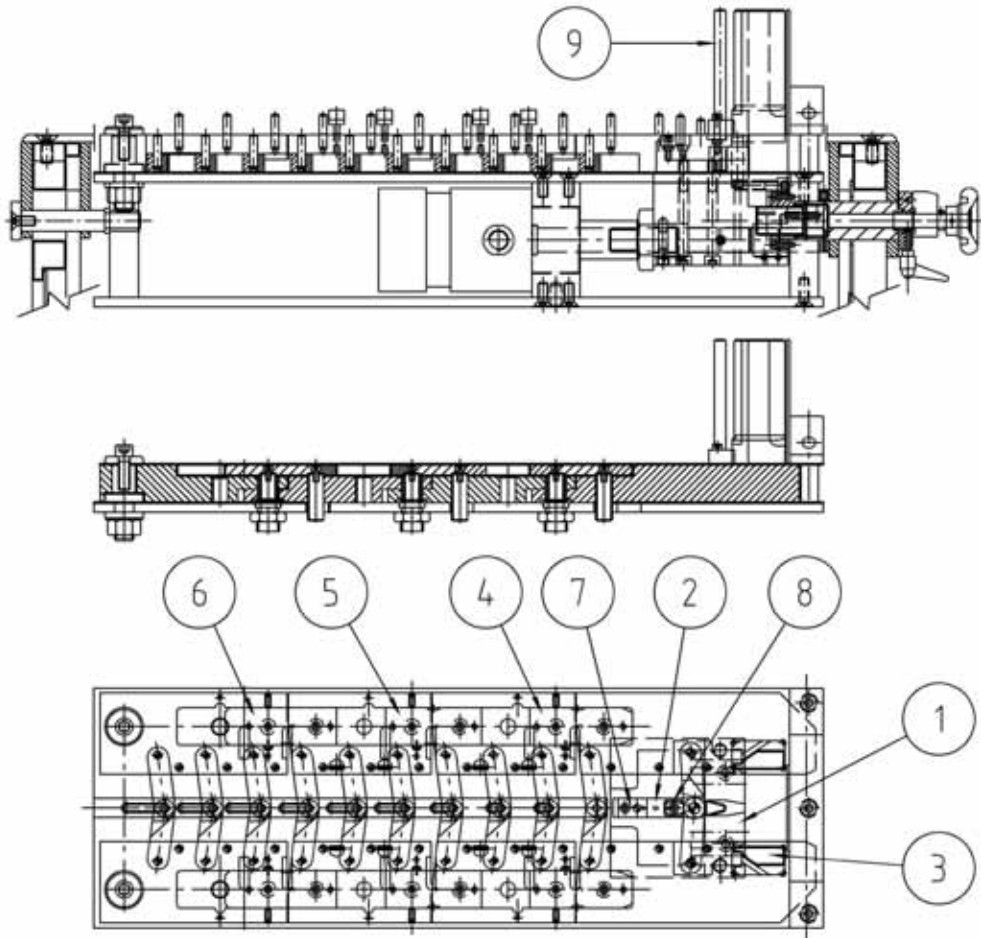





101	01	Electro-valve	VSE/3/2/B-14/1	Oleostar
102	04	Coil 24V DC x EV L.6		
101	01	Electro-valve	MD1.D.S3	Duplomatic
Ref.	Q.ty	Description	Code initials	Mark
GENERAL TOLERANCES	h7			
	h8			
	h9			
	h10			
	h11			
h12				
h13				
h14				
h15				
h16				
h17				
h18				
h19				
h20				
h21				
h22				
h23				
h24				
h25				
h26				
h27				
h28				
h29				
h30				
h31				
h32				
h33				
h34				
h35				
h36				
h37				
h38				
h39				
h40				
h41				
h42				
h43				
h44				
h45				
h46				
h47				
h48				
h49				
h50				
h51				
h52				
h53				
h54				
h55				
h56				
h57				
h58				
h59				
h60				
h61				
h62				
h63				
h64				
h65				
h66				
h67				
h68				
h69				
h70				
h71				
h72				
h73				
h74				
h75				
h76				
h77				
h78				
h79				
h80				
h81				
h82				
h83				
h84				
h85				
h86				
h87				
h88				
h89				
h90				
h91				
h92				
h93				
h94				
h95				
h96				
h97				
h98				
h99				
h100				
h101				
h102				
h103				
h104				
h105				
h106				
h107				
h108				
h109				
h110				
h111				
h112				
h113				
h114				
h115				
h116				
h117				
h118				
h119				
h120				
h121				
h122				
h123				
h124				
h125				
h126				
h127				
h128				
h129				
h130				
h131				
h132				
h133				
h134				
h135				
h136				
h137				
h138				
h139				
h140				
h141				
h142				
h143				
h144				
h145				
h146				
h147				
h148				
h149				
h150				
h151				
h152				
h153				
h154				
h155				
h156				
h157				
h158				
h159				
h160				
h161				
h162				
h163				
h164				
h165				
h166				
h167				
h168				
h169				
h170				
h171				
h172				
h173				
h174				
h175				
h176				
h177				
h178				
h179				
h180				
h181				
h182				
h183				
h184				
h185				
h186				
h187				
h188				
h189				
h190				
h191				
h192				
h193				
h194				
h195				
h196				
h197				
h198				
h199				
h200				

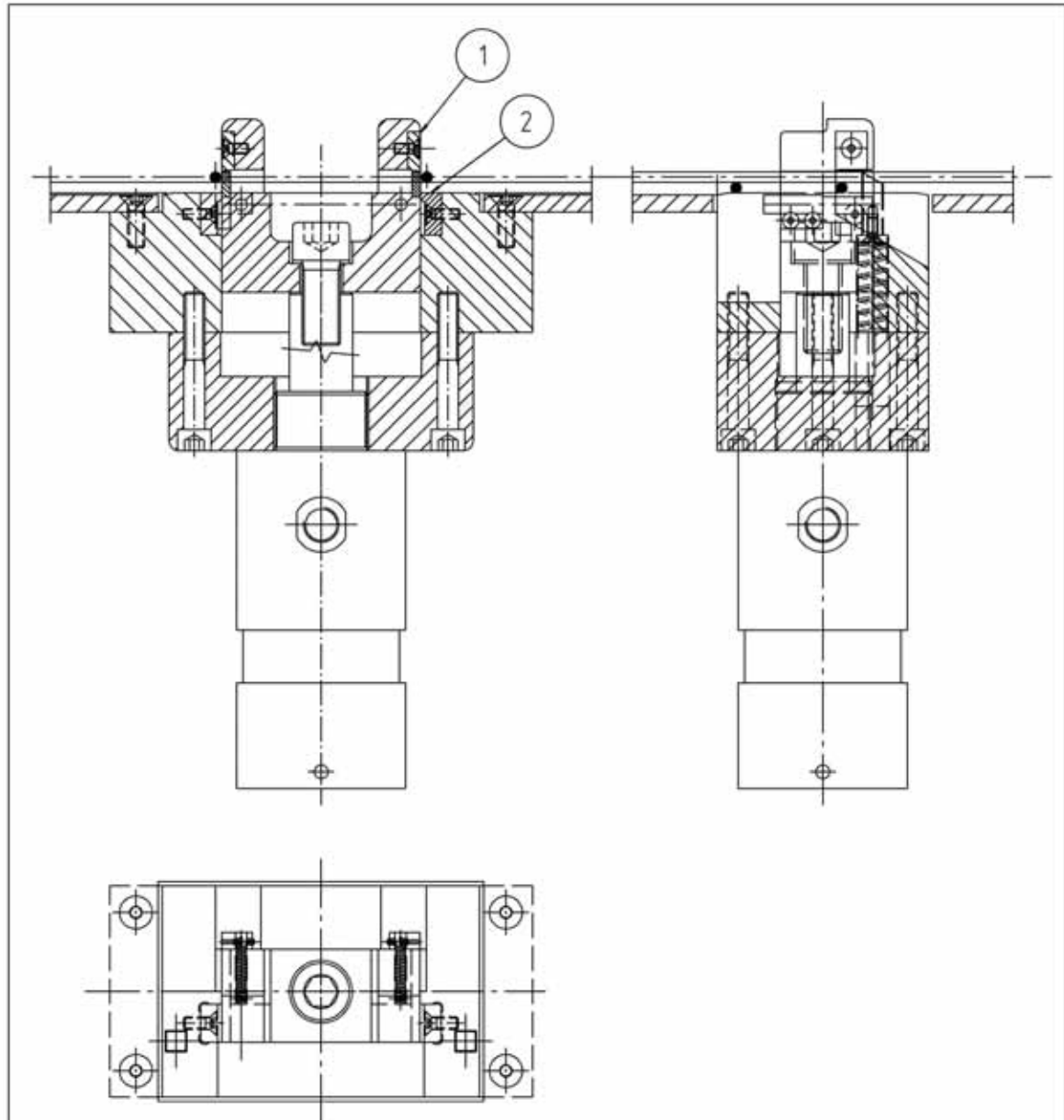

  
**M.T.S. SpA**  
 MACCHINE E TRASFERTI SPECIALI PER LA LAVORAZIONE DEL TUBO  
 M.T.S.SpA ALBANO S.A. (BG) ITALY Tel.035-581191 - fax 035-581509  
 M.T.S.SpA PROVAGLIO D'ISEO (BS) ITALY Tel.030-983178 - fax 030-9823814


SI RISERVA PER QUESTO DISEGNO OGNI DIRITTO DI PROPRIETA' RICOSTRUZIONE E SFRUTTAMENTO AI SENSI DELL'ART.2579 C.C. #99 L.24-4-1941 N



9	Bending plug	2	937-081			
8	Bending boss	1	937-030			
7	Bending boss	1	937-029			
6	Plate 400 mm	2	937-014			
5	Plate 200-300 mm	2	937-013			
4	Plate 50-100-150 mm	2	937-012			
3	Counterbending boss	2	937-011			
2	Bending boss	1	937-003			
1	Bending boss	1	937-001			
POS.	DESCRIPTION	Q.ty	Drawing.N.	MATERIAL	DIMENSION	FINISHING
GENERAL TOLERANCES	±0.3					
	±0.2					
	±0.12					
	±0.08					
	±0.05					
	Mod.	Description	Date	Signature		
 <p>MACHINE E TRANSFER SPECIALI PER LA LAVORAZIONE DEL TUBO M.T.S.SpA ALBANO S.A. (BG) ITALY Tel.035-581191 - fax 035-581509 M.T.S.SpA PROVAGLIO D'ISEO (BS) ITALY Tel.030-983178 - fax 030-9823814</p>			Date	Replaced by	It replaces the	
			16/07/2003			
			Drawing: Colpani D.	Customer	Scale 1:6	
			Drawing, N.	ANNEX 4		

SI RISERVA PER QUESTO DISEGNO OGNI DIRITTO DI PROPRIETA' RICOSTRUZIONE E SFRUTTAMENTO AI SENSI DELL'ART.2578 C.C. #99 L.24-4-1941 N



2	Lower boss	2	937-048							
1	Upper boss	2	937-047							
POS.	DESCRIPTION	Q.ty	Drawing.N.	MATERIAL	DIMENSION	FINISHING				
GENERAL TOLERANCES	h7	f7	Machine EQUIPMENT FOR CUTTING AND BENDING							
	h8	f8	Detail CUTTING UNIT							
	h9	f9	ASSEMBLY							
	h10	f10	Mod.	Description	Date	Signature				
	h11	f11	 <p>MACHINE E TRANSFER SPECIALI PER LA LAVORAZIONE DEL TUBO M.T.S.SpA ALBANO S.A. (BG) ITALY Tel.035-581191 - fax 035-581509 M.T.S.SpA PROVAGLIO D'ISEO (BS) ITALY Tel.030-983178 - fax 030-9823814</p>							
	h12	f12					Date	20/03/2003	Replaced by	It replaces the
	h13	f13					Drawing	Colpani D	Customer	Scale 1:2.5
	h14	f14					Drawing. N.	ANNEX 5		
	h15	f15								

SI RISERVA PER QUESTO DISEGNO OGNI DIRITTO DI PROPRIETA' RICOSTRUZIONE E SFRUTTAMENTO AI SENSI DELL'ART.2579 C.C. #99 L.24-4-1941 N

