

# Confocal Fiber Displacement Sensor

ZW-8000/7000/5000 Series

Light weight 27 g\*1 × Outer diameter 12 mm

Transparent object thickness 15 μm\*2

- White light confocal principle  
Ultra-high-speed, ultra-high-precision measurements
- Ultra-compact, ultra-lightweight, flexible  
Easy integration into machines
- 3 controllers and 22 sensor heads  
For various applications

ZW-5000      ZW-7000      **NEW** ZW-8000

Square-shaped straight type      **NEW** Pen-shaped straight type      **NEW** Pen-shaped right angle type

# Easy-to-integrate sensor measures any material

Reliable and accurate in-line measurements

## Transparent object thickness : 15 $\mu\text{m}$

Ultra-high-precision thickness measurements of transparent sheets

Linearity	$\pm 0.3 \mu\text{m}$
Measurement period	60 $\mu\text{s}$
Angle characteristic	$\pm 25^\circ$
Measuring range	$\pm 2 \text{ mm}$

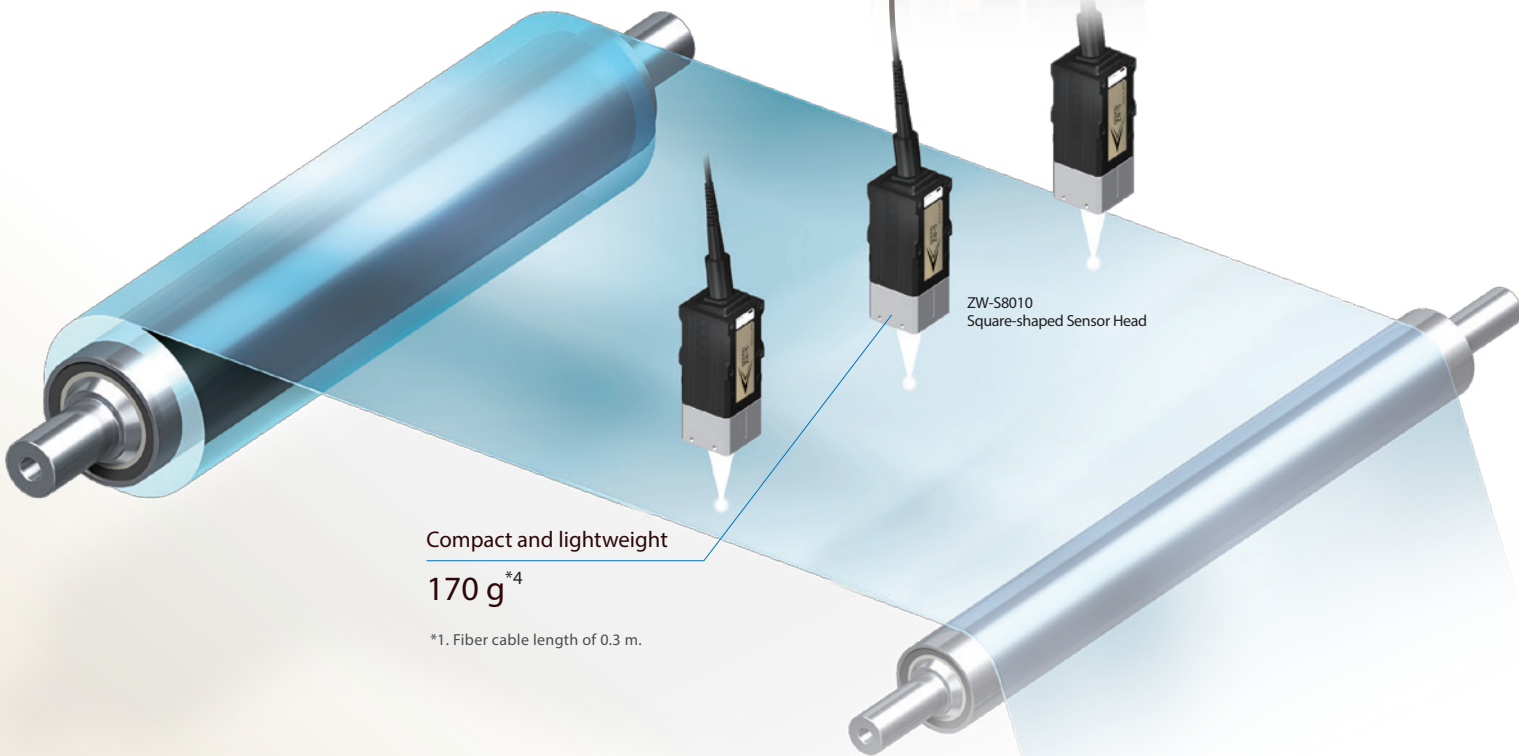

Compact and lightweight

170 g<sup>\*4</sup>

\*1. Fiber cable length of 0.3 m.

# Measurement period : 20 μs

Ultra-high-speed assembly inspection of ECU boards

Preamplifierless  
& flexible fiber cable

Bending radius: 20 mm

Linearity	±0.45 μm
Spot diameter	130 μm
Measuring range	±0.7 mm

High-precision synchronization  
between devices with 1 μs jitter

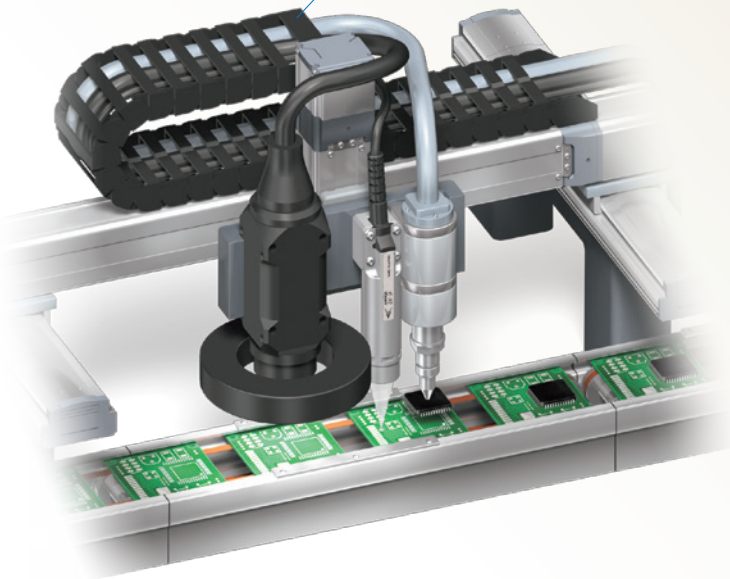
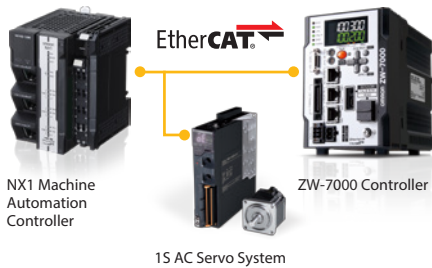

## Saving space

### Bonding machines

ZW-SPR5007 Pen-shaped  
Right Angle Sensor Head

Low installation  
height

27.5 mm

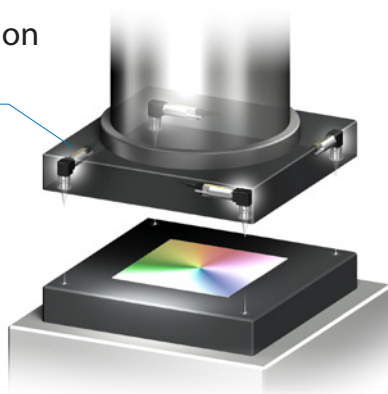

### Inclination measurement for automotive camera module assembly

ZW-SP7007 Pen-shaped  
Straight Sensor Head

Ultra-compact,  
ultra-lightweight

12-mm dia./27 g\*2

\*2. Fiber cable length of 0.3 m.

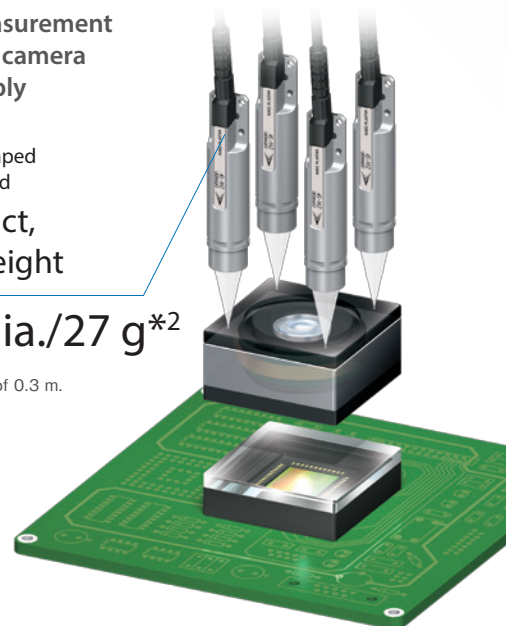

Note: The resolution, measurement period, angle characteristic, measuring range, linearity, spot diameter, and other specifications differ among models. Refer to the datasheet for details.

# Unsurpassed stable in-line measurement

The ZW Series has continued to evolve, meeting the customer's measurement demands and creating a reliable solution for in-line measurements.

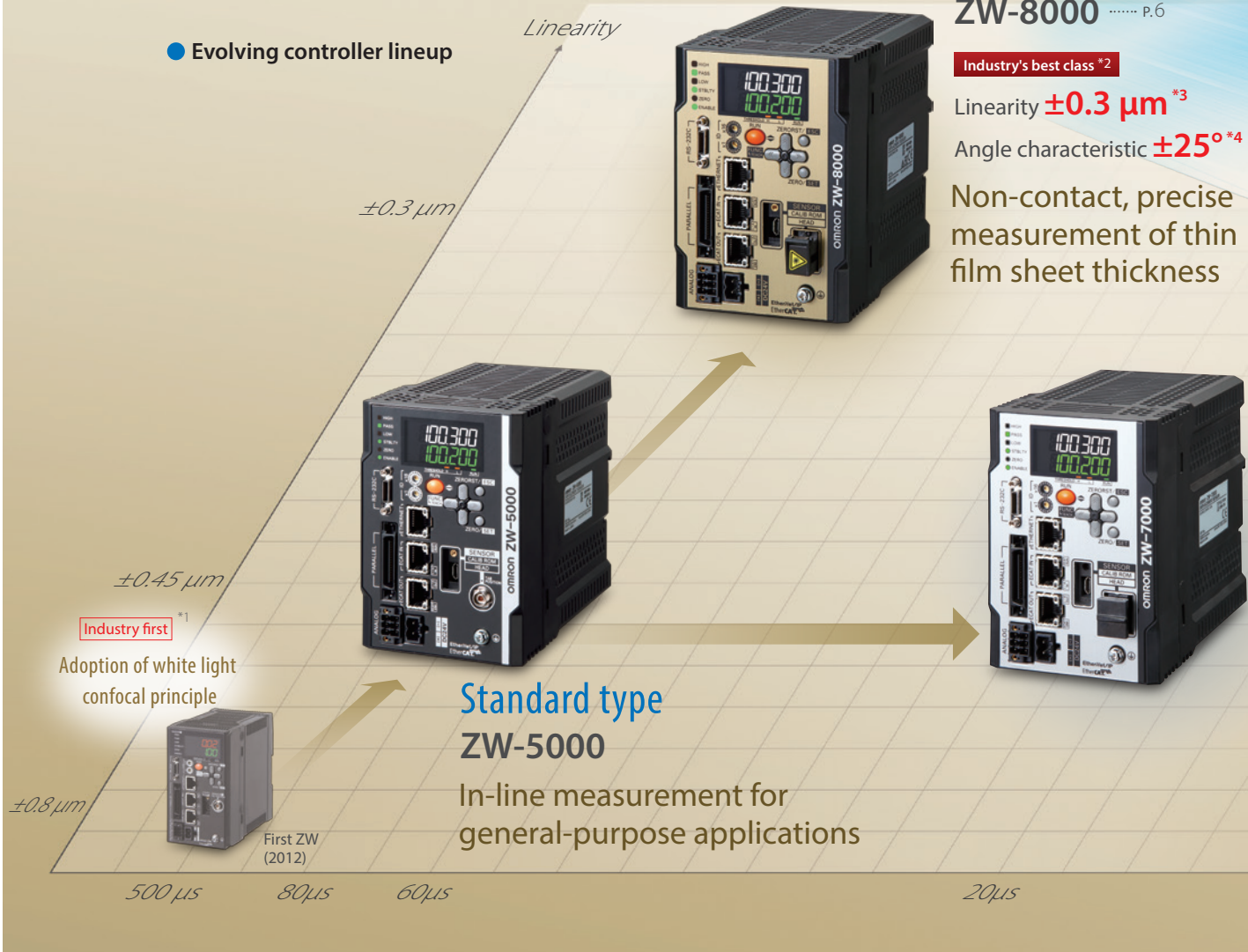

## Coaxial measurement based on color

### White light confocal principle

Omron is among the first in the industry to adopt the white light confocal principle when it introduced the ZW Series. This principle allows a stable moving measurement of objects in any mixed conditions such as coarse, curved, inclined or narrow areas.

\*7. OCFL: Omron Chromatic Focus Lens. Refer to page 17 for details.

### Principle

White light produced by the light source ((1)) is focused at different points for each color (wavelength) ((2)) using an OCFL \*7 created using Omron's unique compact optical design technology. Only the light that is focused on the object is received as reflected light ((3)), and this wavelength information is converted to distance with a spectrometer ((4)), and the height is then measured. Unlike triangulation systems, as the emitted light and received light are positioned along the same axis, the measurement point remains the same at any position in the measuring range so that precise measurements can always be achieved.

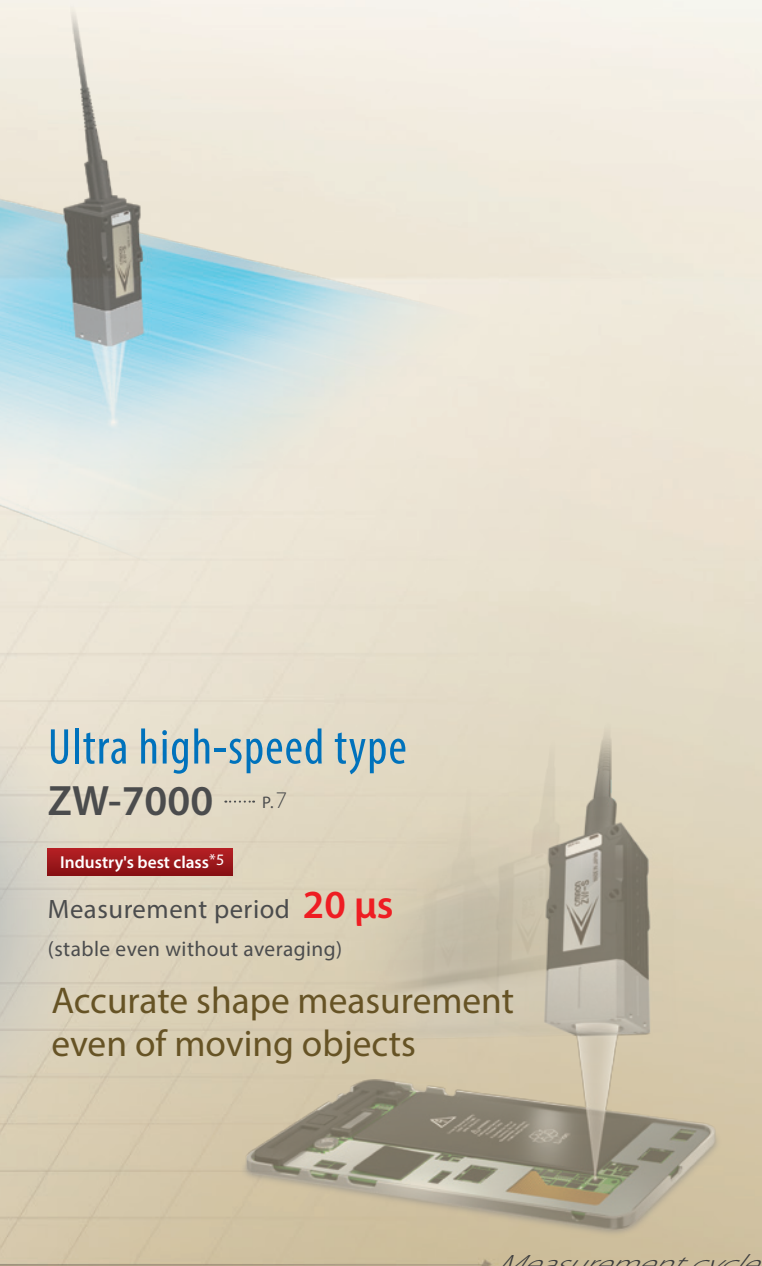

**Ultra high-speed type**  
**ZW-7000** ..... P.7

**Industry's best class\*5**  
Measurement period **20 μs**  
(stable even without averaging)

Accurate shape measurement  
even of moving objects

→ *Measurement cycle*

**Smallest in class\*6**

**Ultra-small head**

Compact and easy to use for measuring any shape  
..... P.8

One-shot synchronous  
measurement of multiple  
points on small parts  
through close installation



**● Evolving head lineup**

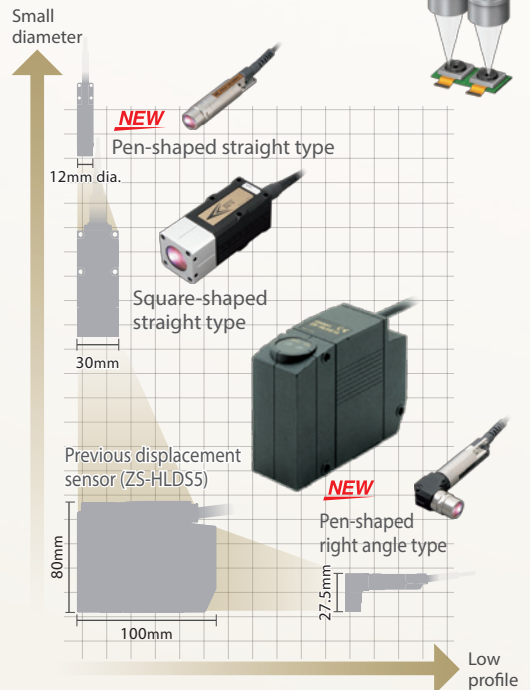

\*1/\*2/\*5/\*6. Based on Omron investigation in July 2018.  
\*3. Material setting for the Omron standard mirror surface target:  
Error from an ideal straight line when measuring on mirror surface.  
\*4. Typical value of the ZW-S8010/ZW-S7010/ZW-S5010 Sensor Heads.

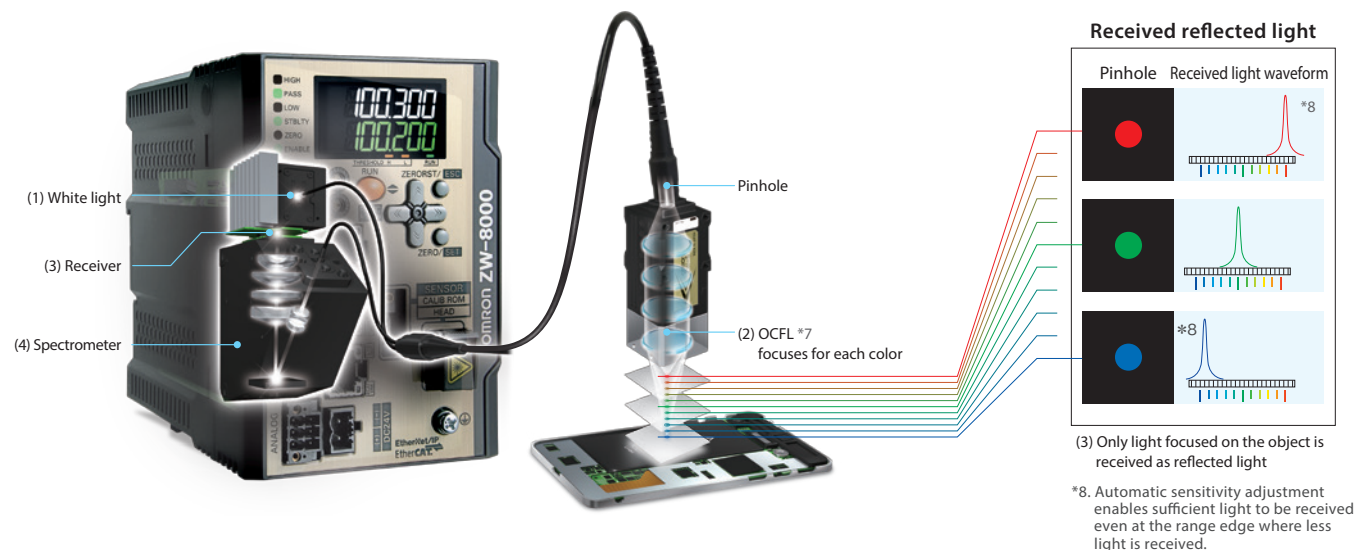



## Controller

# Solutions for any in-line measu

For measurement of rattling or inclined "transparent objects or mirror surfaces"

**NEW** Ultra-high-precision, high-speed type **ZW-8000**

## High-precision in-line measurement of rattling or inclined shiny, thin, or minute parts



Curved surfaces Transparent objects Minute objects

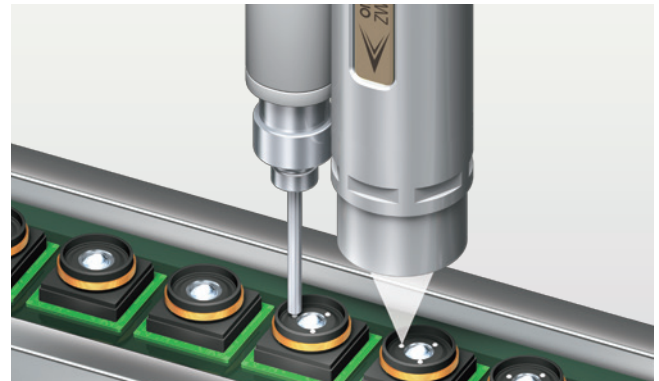

Measurement of coated plastic height

### Mirror surfaces (inclined or curved surfaces)

Omron's, unique, white light confocal displacement sensor provides higher resolution measurements of angled or curved and shiny surfaces than traditional laser displacement sensors.

>> Mechanism  
p.19 High angle characteristic

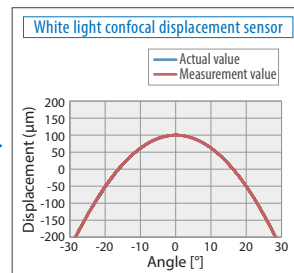
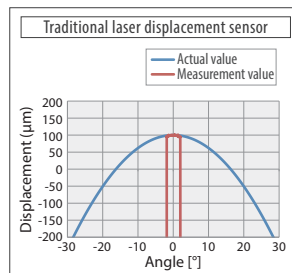

Angle characteristic  
**±25°**  
for shiny surfaces  
\*1

### Transparent objects

The ZW-8000 Series can measure the top and bottom surfaces of a thin transparent sheet or film by separating the light reflected from both surfaces, which is difficult with conventional laser displacement sensors.

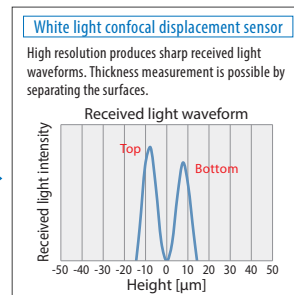
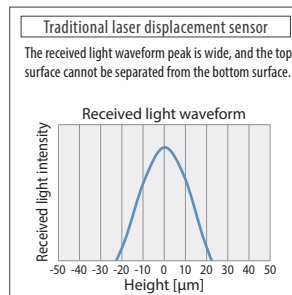
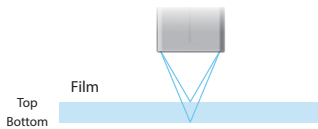

Transparent object thickness from  
**15 μm**  
\*2

### Minute objects

Thanks to its very small spot diameter, the ZW-8000 Series can measure targets on minute objects extremely precisely, which is impossible with a conventional laser displacement sensor with a large spot diameter.

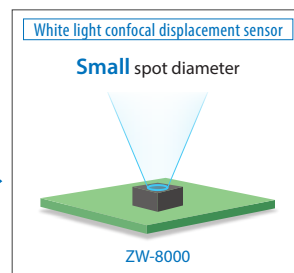
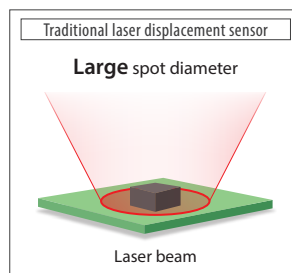

Min. spot diameter  
**4 μm**  
\*3

### ● A variety of sensor heads with a small spot diameter to suit your measurement conditions

Sensor head type	Square-shaped straight			Pen-shaped straight		Pen-shaped right angle	
Model	ZW-S8010	ZW-S8020	ZW-S8030	ZW-SP8007	ZW-SP8010	ZW-SPR8007	ZW-SPR8010
Spot diameter	4-μm dia.	7-μm dia.	10-μm dia.	7-μm dia.	10-μm dia.	8-μm dia.	11-μm dia.

\*1. Typical value of the ZW-S8010/ZW-S7010/ZW-S5010 Sensor Heads.

\*2. Typical value of the ZW-S8010 Sensor Heads when transparent objects with refractive index of 1.5 are measured. \*3. Typical value of the ZW-S8010 Sensor Heads

Note: The ZW-5000 standard type is available for measurements with standard precision and speed.

# Measurement application

Measurement of "Coarse surfaces" moving at high speed

## Ultra-high-speed, high-precision type ZW-7000

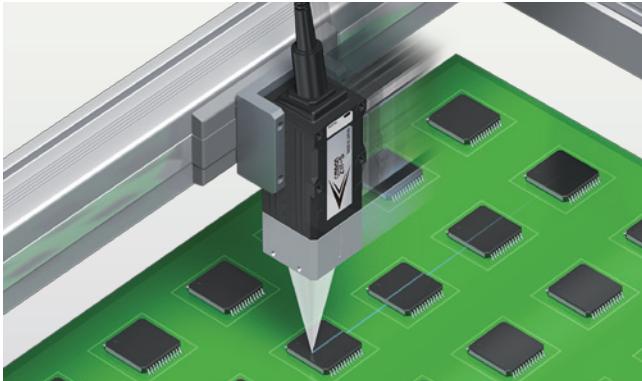

Measurement of height of chips on substrate during movement

Ultra high-speed, stable measurement of diffuse reflective objects during movement

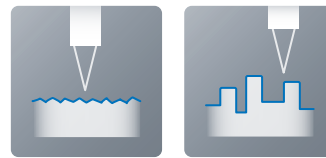

Coarse surfaces

Shape

### Shape

Using conventional sensors, the measurement accuracy can be achieved by increasing the averaging times, but downside is that this lowers the profile reproduction accuracy. The ZW-7000 acquires a sharp profile by sampling as fast as 20 μs without averaging, solving this issue.

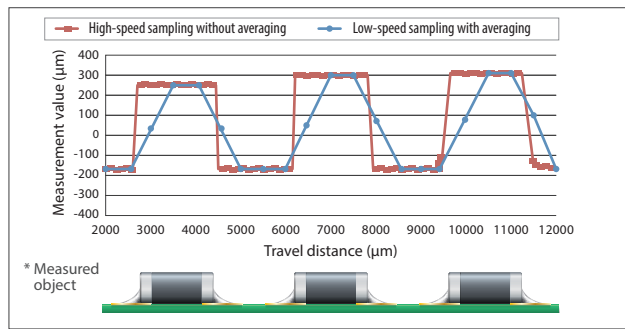

Minimum sampling period  
20 μs

### Flatness of coarse surfaces \*5

Our white light confocal displacement sensors can provide accurate flatness measurement by tracing an object once without being affected by its excessive reflection, the sensor head direction, nor the material hairline direction, which are difficult to track with a conventional laser displacement sensor.

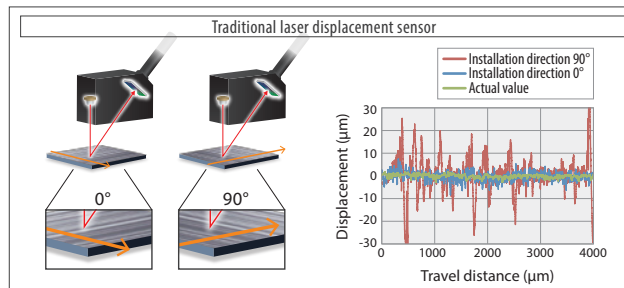

### >> Mechanism

p.18 Stable measurements of coarse surfaces

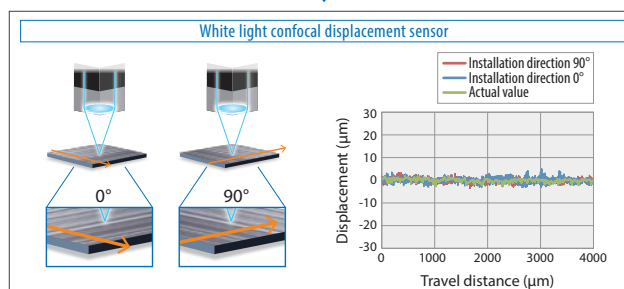

Moving resolution  
1/5  
(compared to previous principle)  
\*6

\*4. Please ask Omron sales representative for product data for other than the ZW-S7030. \*5. Objects with machining marks or hairline pattern \*6. ZW-S7020.

\*7. Please ask Omron sales representative for product data for other than the ZW-S7020.

Note: All measurement graphs represent typical examples. Measurement may be affected by the shape or material of the object being measured.

Before final installation, test the sensor required for the application to validate that the desired measurements have been obtained.

## Sensor head

# A wide sensor head offering for diverse integr

### New ultra-small sensor heads make integration more flexible

The continued evolution of products as they have become thinner, more curved, and more compact has meant that the inspection process has also become more difficult, and this has necessitated visualization and assembly control in the upstream assembly process.

In response to this, Omron has developed a lineup including both square-shaped type sensor heads with long measurement distance, and ultra-small pen-shaped type (straight or right angle) sensor heads that can be installed in narrow spaces.

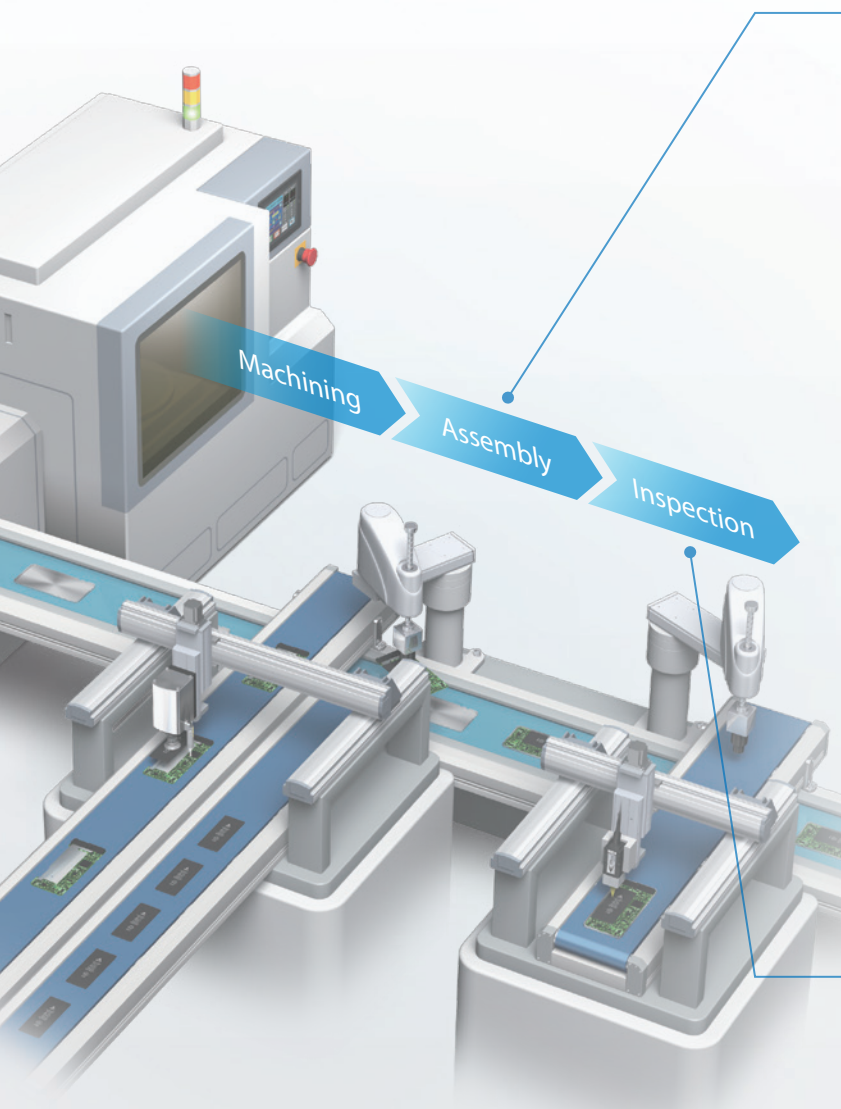

### Ideal for assembly process

#### Reduce interference with stages, robots, or structures

**NEW**

#### Pen-shaped straight type

Measuring range  
7±0.3 mm/10±0.7 mm

Linearity	±0.3 μm
Weight*1	approx. 27 g

Note: Typical values



**NEW**

#### Pen-shaped right angle type

Measuring range  
7±0.3 mm/10±0.7 mm

Linearity	±0.45 μm
Weight*1	approx. 31 g

Note: Typical values



### Ideal for inspection process

#### Perfect solution for strict inspection accuracy

#### Square-shaped straight type

Measuring range  
10±0.5 mm/20±1 mm/  
30±2 mm/  
40±3 mm \*2

Linearity	±0.3 μm
Weight*1	approx. 170 g

Note: Typical values



\*1. ZW-8000/ZW-7000 Series with 0.3 m fiber cable.

\*2. The 40 mm type is only available for the ZW-7000 Series.

\* The photo shows the ZW-8000 Series. This size is the same for the ZW-7000/5000 Series.



# Installation requirements

## Installation in narrow spaces



Installation is also possible in places with limited space with pick-up nozzles, positioning cameras, or jigs.

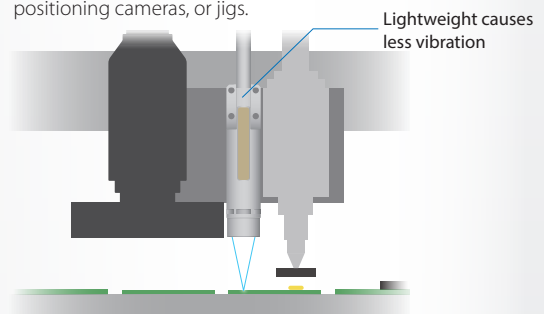

## Low-profile, space-saving installation



High-precision control is possible by installing a low-profile head, even in places with strict height restrictions.

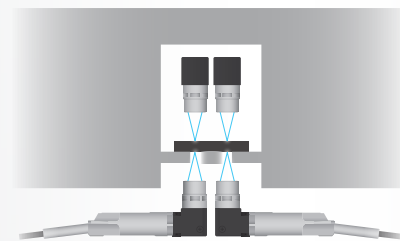

## Chip die count

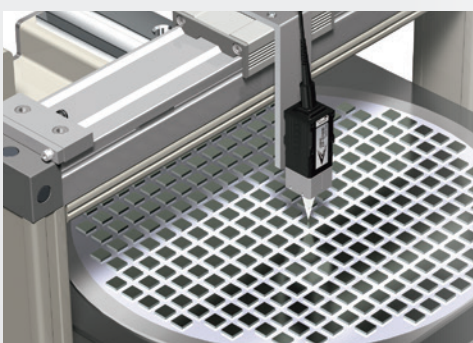

As the heads have no orientation, there is no need to change the angle.

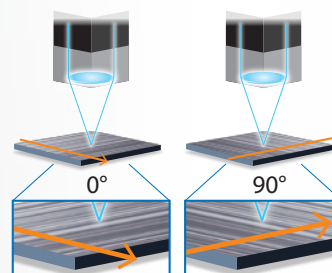

## Usability

# Reduce production cycle times through

### Save Time and Money: No need to rotate the sensor

A conventional laser displacement sensor measures the height of an object based on the position of the spot on the receiver. The machine requires an extra step to rotate the sensor according to the object shape or moving direction. Our white light confocal displacement sensor can measure from the same installation position while moving in any direction, with no restriction on installation direction.

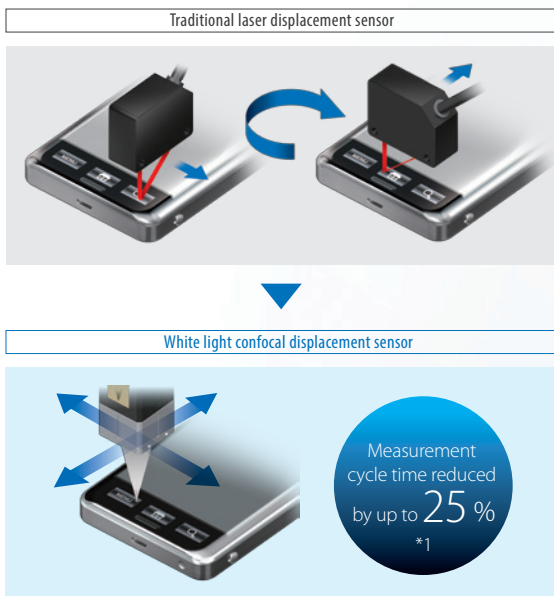

\*1. Calculated when an object with irregular surface was measured in both the vertical and horizontal directions.

>> **Mechanism**  
p.19 Direction free

### Flexible fiber cable for easy installation

The controller connects to the sensor head through a 3 mm diameter flexible fiber cable. The cable has cleared a bending test consisting of 3,000,000 repetitions\*2 for reliable application on moving parts.

\*2. Omron's bending test condition: 3,000,000 bends to a 20 mm bending radius

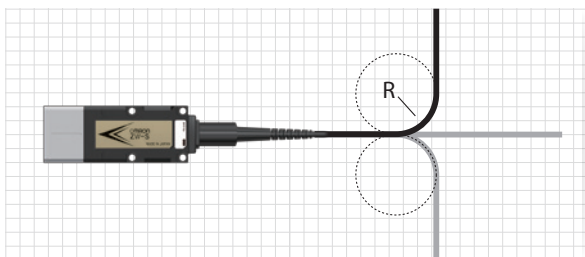

### Extension cables for large machines

A 30-m extension fiber cable can be used to extend the distance to up to 32 m, supporting a flexible wiring in a large machine.

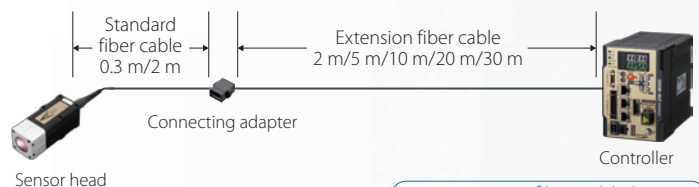

>> **Extension fiber cable lineup**  
p.28 "Order Information Cable"

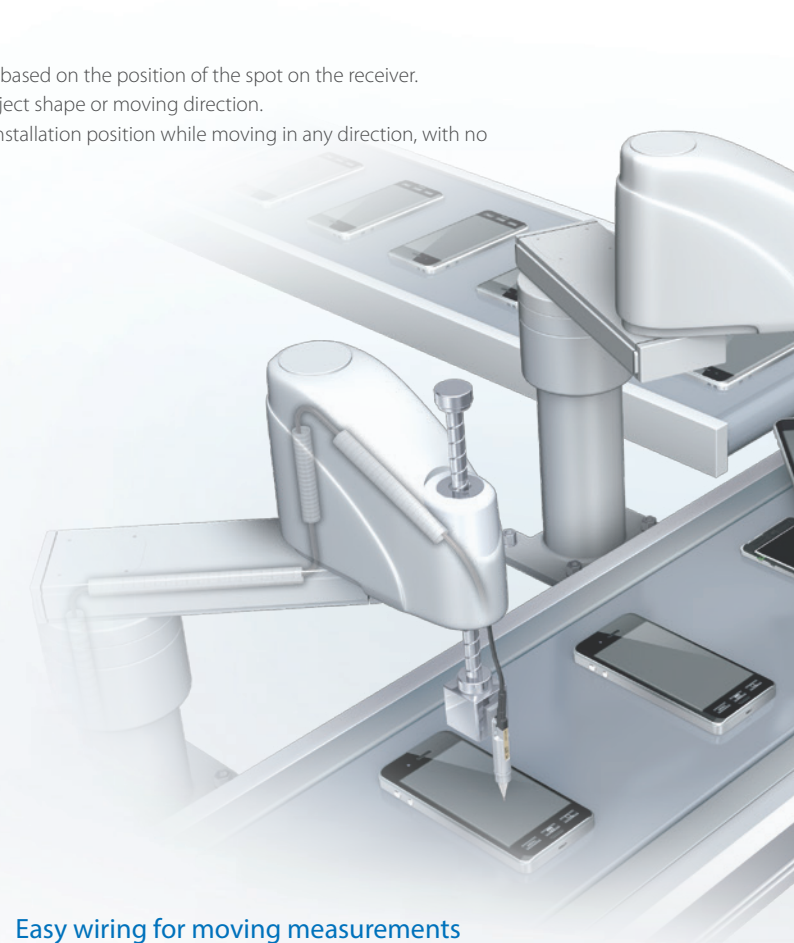

### Easy wiring for moving measurements

No preamplifiers or optical parts are used in the fiber cable, which makes it easy to route the cable through a cable carrier or protective conduit for moving measurements.

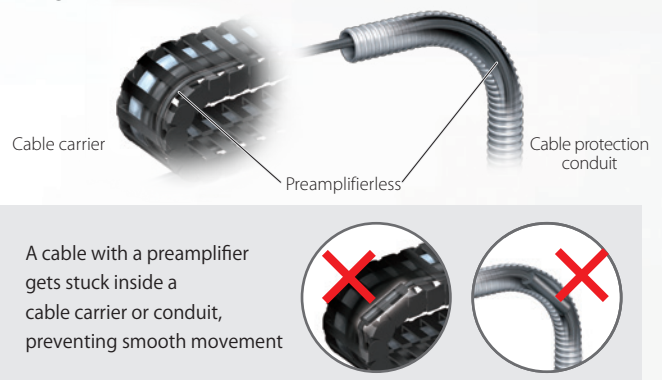

# efficient arrangement and movements

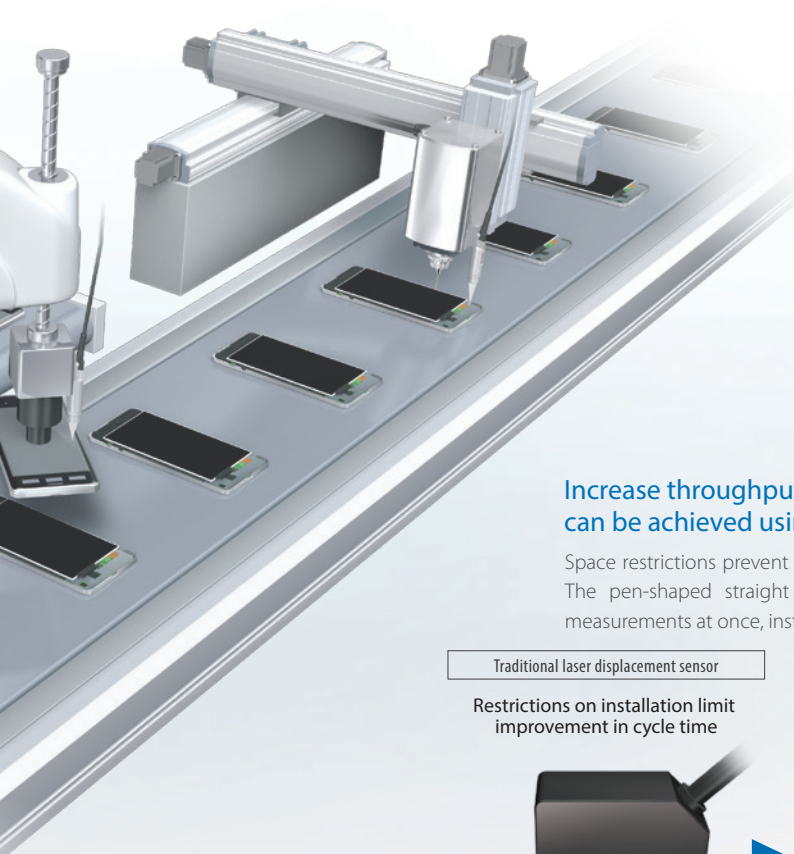

## Compact fanless controller

The compact sensor controller, which integrates the optical unit including the light source and spectroscopy, can be mounted on a DIN track, saving space in a control panel. The fanless structure can be used in cleanrooms for manufacturing semiconductors and electronic components.

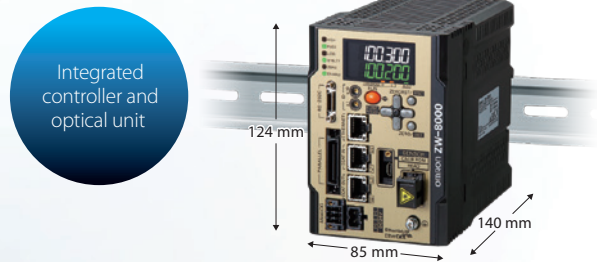

## Increase throughput: Simultaneous measurements can be achieved using multiple sensor heads

Space restrictions prevent side-by-side installation of many traditional laser displacement sensors. The pen-shaped straight sensor heads can be installed close together to obtain multiple measurements at once, instead of measuring one at a time, thus reducing measurement time.

Traditional laser displacement sensor

Restrictions on installation limit improvement in cycle time

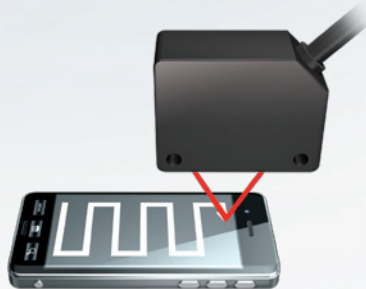

White light confocal displacement sensor

Close installation reduces measurement time

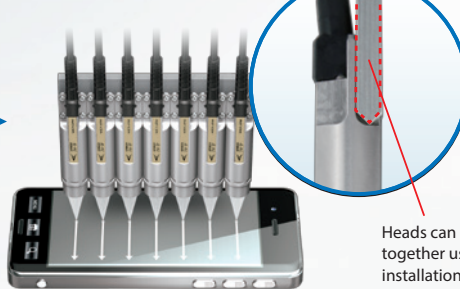

Measurement cycle time reduced by **80% or more**  
\*3

\*3. Performance comparison with previous Omron products

Heads can be installed close together using the dedicated installation plate provided.

## Further Benefits of White Light Confocal

### ● No discrepancy in the measurement point

With a traditional laser displacement sensor, the measurement position and spot size vary with the height. This means there are times when the position cannot be measured with high resolution due to warping and inclination. With a white light confocal displacement sensor, the measurement point remains the same at any position in the measuring range so that precise measurements can always be made.

Traditional laser displacement sensor

Measurement position varies with the height

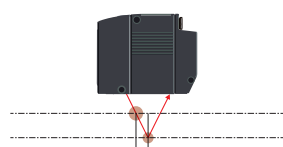

White light confocal displacement sensor

No discrepancy in the measurement position



### ● Measurement in narrow area and by the wall

When a traditional laser displacement sensor measures the inside of a narrow tube or the height of a small depression, the wall often obstructs the reflected light, and the orientation of the sensor and object must be adjusted many times. A white light confocal displacement sensor can measure the points in narrow spaces or small objects, without changing its installation orientation, because the emitted light and reflected light are positioned along the same axis.

Failure to measure due to obstruction of the reflected light by the wall.

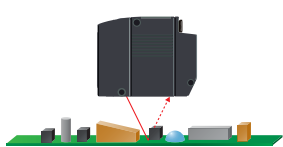

The reflected light is not obstructed by the wall.

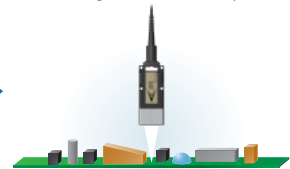

## Usability

# Reduce setup and tuning time

### Reduced work - EMC measures and thermal design are not required

The sensor head contains no electronic parts and indicators that generate noise and heat. The sensor head design maintains stable operation in installations with electronic or magnetic noise. Devices in close proximity and measurement values are not affected by noise or heat from the sensor head.

#### EMC measures

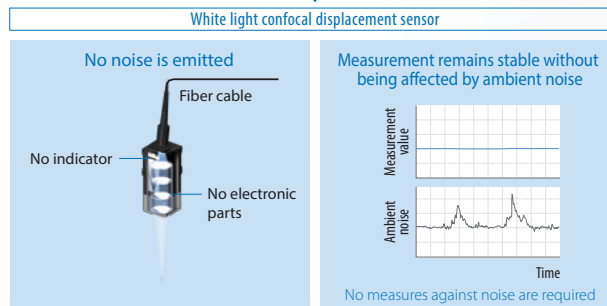
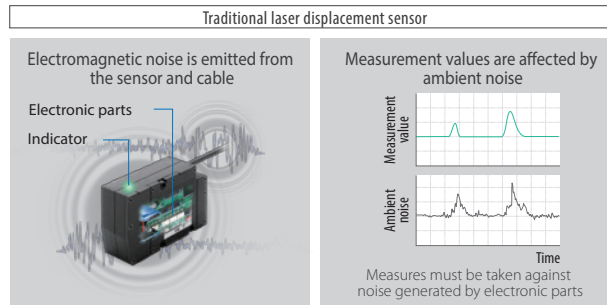

#### Thermal design

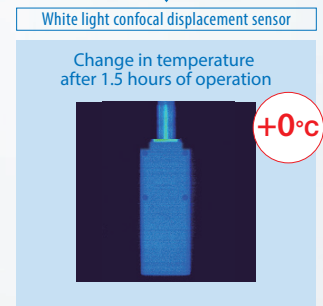
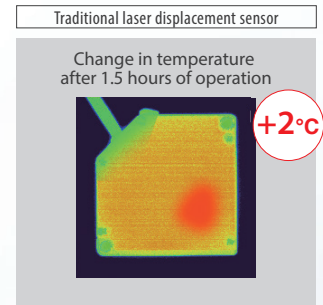

Patent pending

### Multi-point scaling for stable measurements

The ZW Series measures up to 10 points to minimize measurement errors. \*1 Even when the sensor head is installed at an angle or measures objects through glass, stable measurements can still be achieved, which is difficult with conventional 2-point scaling.

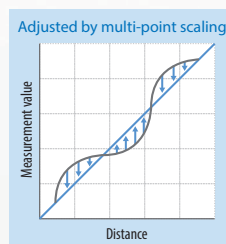
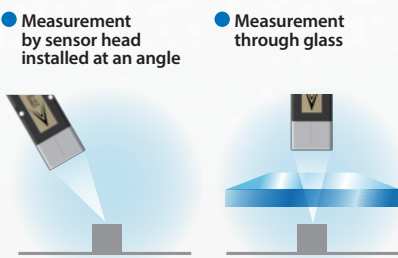

\*1. Supported on ZW-8000 Series

### No laser safety measures required

A white light source \*2 eliminates the need for safety measures around the machine and safe use training for workers that are required for a laser light source.

#### Previously safety measures or laser were required

When a laser displacement sensor was used, a shield around the machine for safety was required and workers had to be trained for safe use.



\*2. The ZW-8000 Series is categorized as Class 1

Patented

### Calibration ROM ensures compatibility and precision

The sensor controller is compatible with sensor heads, which enables quick replacement and saves costs. Each sensor head has its own calibration ROM that is used to load calibration values into the sensor controller, providing compatibility and high-precision measurements.

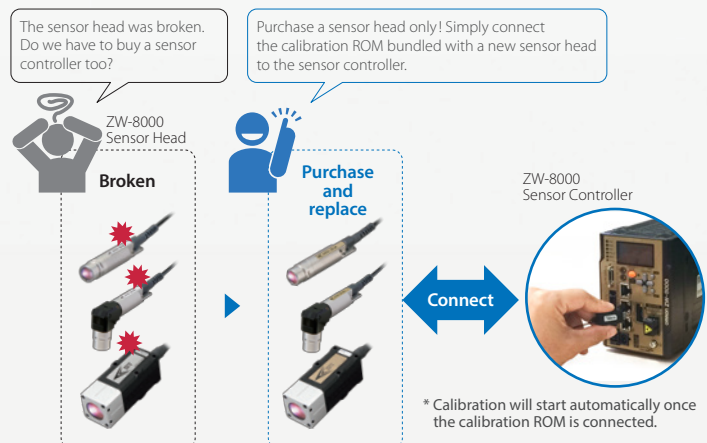

\* Any of three ZW-8000 Sensor Head types can be connected to the ZW-8000 Sensor Controller.

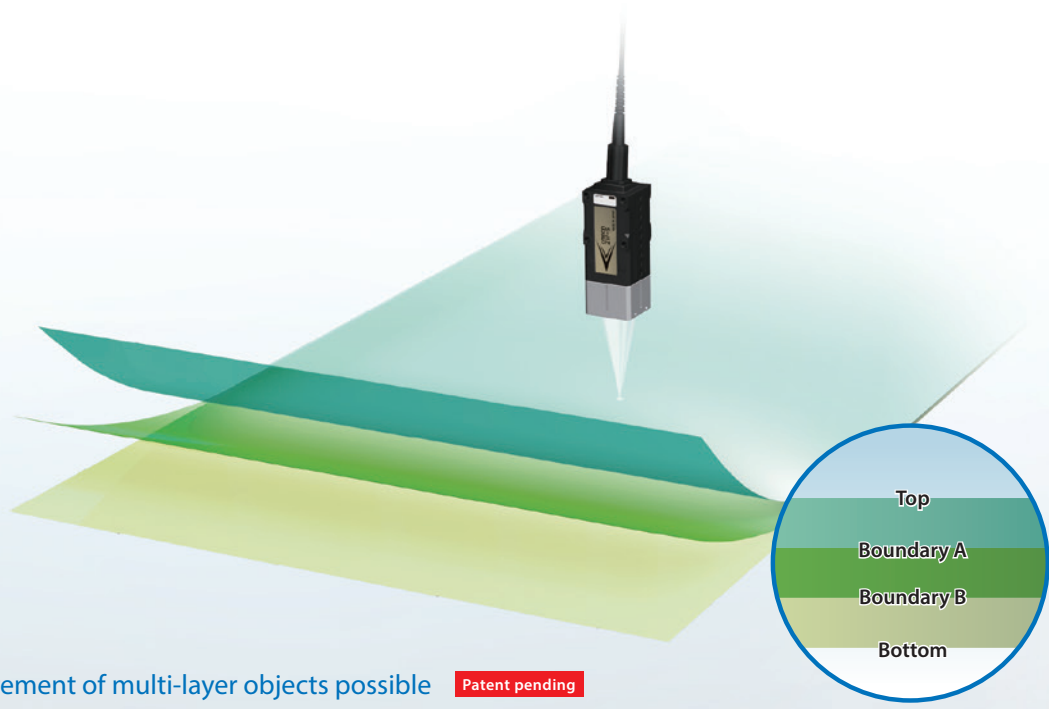

Edges of object

**Stable measurement of multi-layer objects possible with advanced function "EdgeTracks" \*2** Patent pending

When measuring objects with multiple layers, the white light confocal displacement sensor can stably measure target edges even if the object rattles and certain of the edges cannot be measured.

**Traditional laser displacement sensor**

If certain of the edges are outside the measuring range (cannot be measured) due to vibrations of the object, the other edges are numbered incorrectly.

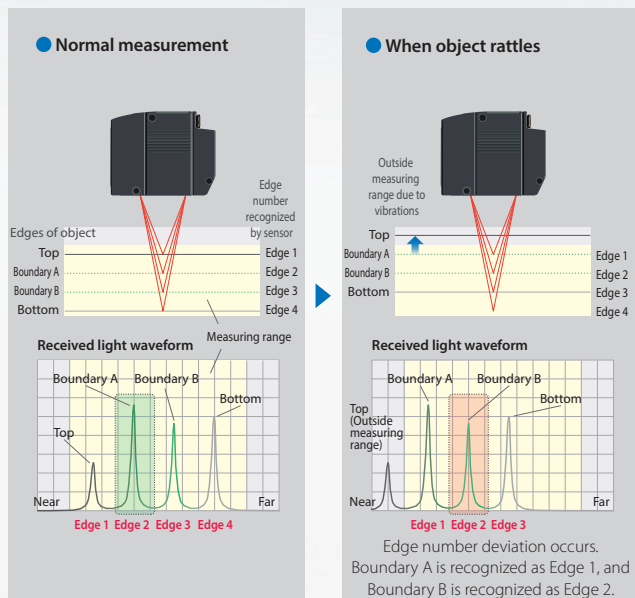

**White light confocal displacement sensor**

The EdgeTracks function can take stable measurements with no edge number deviation, even if certain of the edges cannot be measured.

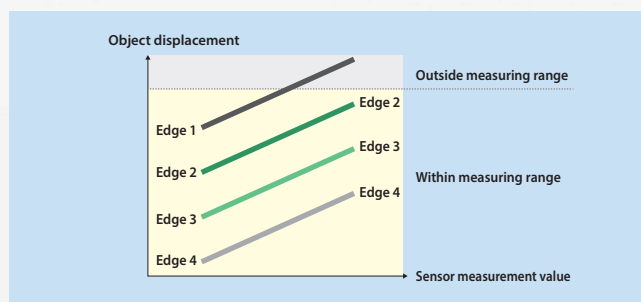
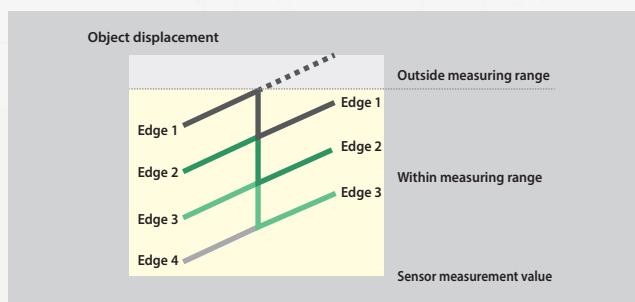
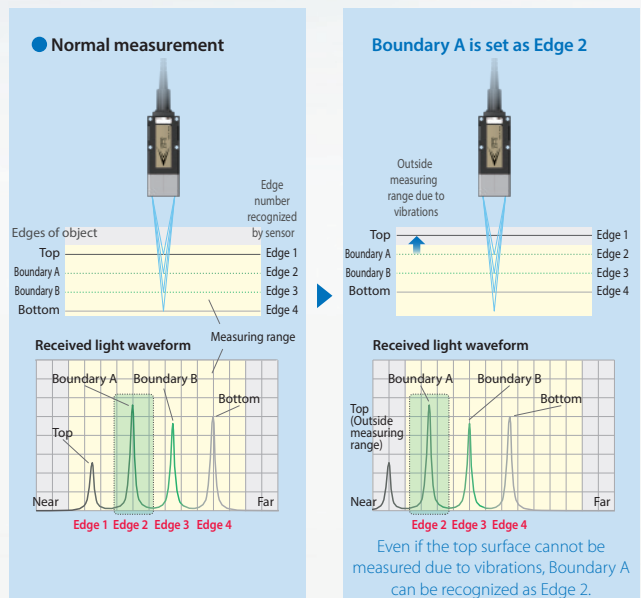

\*2. Supported only on ZW-8000 Series

## System

# Precise measurement of “target positions” through synchronous measurement with

To eliminate measurement errors due to a position offset during moving measurement, the ZW Series provides the functionality to link moving parts with measurement timing (external synchronous measurement mode).

## Movement measurement linked to stage position information <sup>\*1</sup>

In addition to excellent angle characteristics, synchronization with object movement is required to measure the shapes of objects with sharply curved edges (e.g., cover glass of smartphone). Moreover, the system to control vertical movement of the sensor head is required to track shapes outside the measurement range.

<sup>\*1</sup> This functionality is available on the firmware version 2.10 or later. If you register as a member after purchasing the product, the latest firmware for the controller is available for free. Refer to the member registration sheet that is enclosed with the product for details.

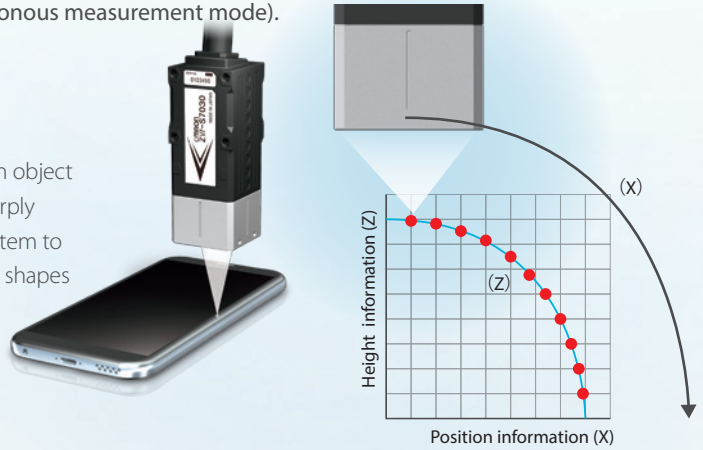

### Previous system

Sensors perform measurement within the same cycle, regardless of stage acceleration and deceleration.

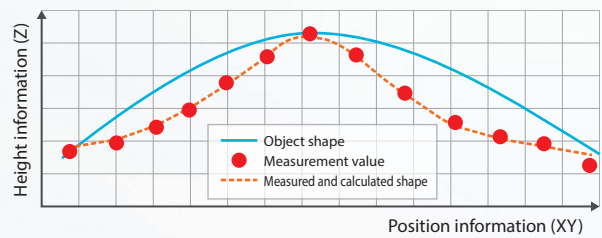
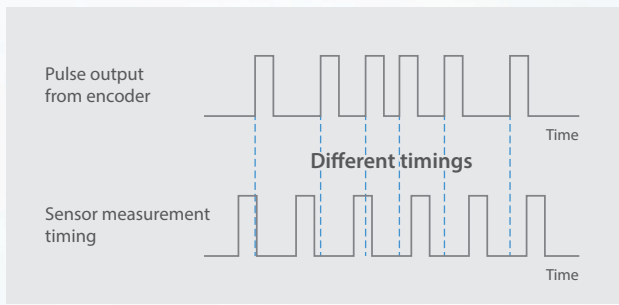

As the measurement position (XY) is not synchronized with the measurement value (Z), an accurate object shape cannot be obtained if the stage accelerates or decelerates.

### ZW Series

Sensors perform measurement based on encoder timing (External synchronous measurement mode)

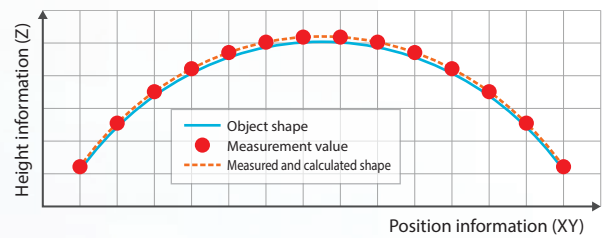
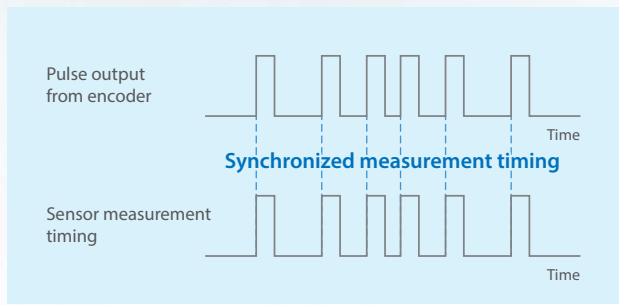

Each sensor synchronizes with pulse output from the encoder, enabling high-precision measurement linked to the XY position, regardless of stage acceleration and deceleration.

## DLL Quick integration into machine HMI

DLL <sup>\*2</sup> files are provided to easily display ZW Series setting screens and measurement results on a Windows/Mac OS PC used as a machine HMI.

Provided DLL	· Settings and measurement conditions reference	· Acquiring light received waveforms
	· Acquiring measurement values	· Logging control

<sup>\*2</sup> If you register as a member after purchasing the product, you can download DLL for free. Refer to the member registration sheet that is enclosed with the product for details.

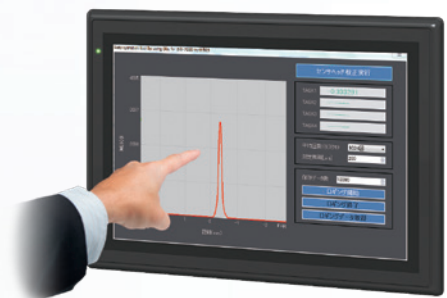

# on moving objects external devices

## More features Sysmac makes moving measurement easy

### Easy setting and measurement through synchronization with EtherCAT

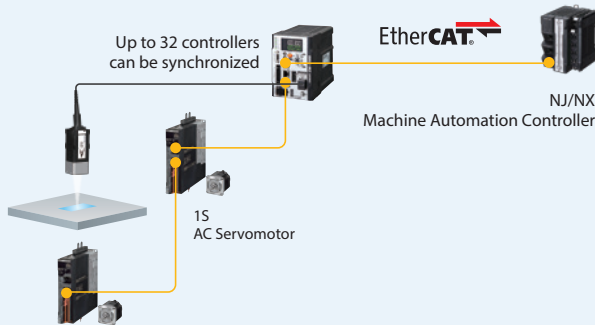

The sensors begin measurement automatically by synchronizing with periodic EtherCAT communication. This system ensures accurate synchronisation between devices with 1  $\mu$ s jitter. The sensor controller also supports **EtherNet/IP™, analog output, and RS-232C**, fitting into a wide range of machines.

### Operations integrated within Sysmac Studio



### Efficient setting of multiple ZW Sensors

You can make settings for all of devices that are connected via EtherCAT with the Automation Software Sysmac Studio. Even when using many sensors, you can copy the setting data to effectively integrate several sensors and easily program the processing between the sensors.

### Easy set-up with Function Blocks



Omron offers Function Blocks (FBs) to make programming for system link applications easier.

Rapid set-up without any programming know-how is possible with an FB which tracks object shapes, FBs used to generate 2D shape data and calculate characteristic point dimensions, and HMI screens used to specify settings and perform measurement.

For details, refer to the SYSMAC-XR014 Dimension Measurement Library on the following URL: [www.ia.omron.com/sysmac\\_xr014](http://www.ia.omron.com/sysmac_xr014)

#### Tracer Control

This method is suitable for measuring shapes whose height varies gradually.

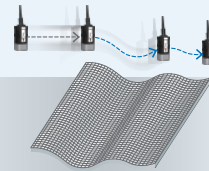

#### Surface Search

This method is suitable for measuring shapes whose height varies greatly and sharply. When the height of the measurement surface changes and it goes outside the measurement range of the displacement sensor, the height of the displacement sensor is readjusted and the measurement is continued.

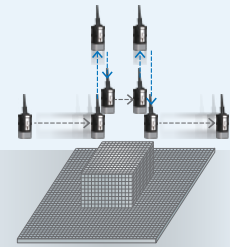

#### Height

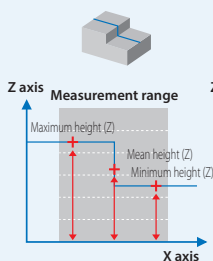

#### Edge position

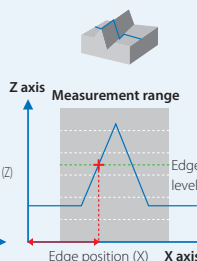

#### Inflection point

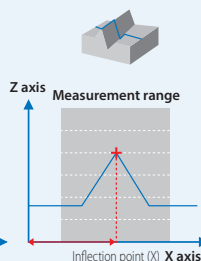

#### Angle

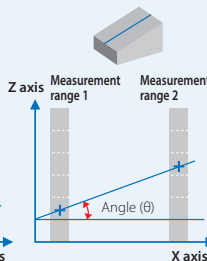

#### Sectional area

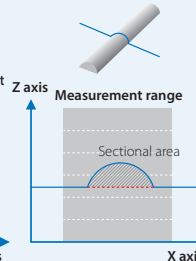

#### Shape comparison

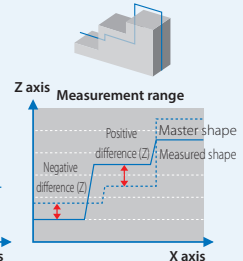

Technical explanation

# New technologies for in-line measurements with

● New technology in ZW Series offering unsurpassed precision and speed



**Ultra-high precision**

## Ultra High Power White Light

The long-term stable, high power white light source was adopted for the ZW-7000 Series to provide fast responses and stable measurements of low-reflective objects. The ZW-8000 Series incorporates a newly-designed white laser for stable measurement of thin transparent sheets and minute shapes.



\* Conceptual illustration

**NEW**



**Ultra-high photoconductivity**

## Precise Core Fiber

The fibers specially designed separately for the ZW-7000 and ZW-8000 Series transmit white light to the sensor head even more efficiently and deliver the lights reflected from other layers to the controller ultra-sensitively, enabling more precise measurement.

**NEW**



**High resolution**

## Advanced Spectrograph I/II

The spectroscope Advanced Spectrograph, which converts the color wavelength into the distance, offers increased waveform resolution. The ZW-8000 Series with the new Advanced Spectrograph II enables ultra-high-precision measurements.

**NEW**



● Common technology throughout the entire series offering unsurpassed usability



**25 times faster data processing speed\*1**

## High Speed Processor

The new processor was designed to increase processing speed for high precision measurements, from white light emission through sensing and processing to data logging.

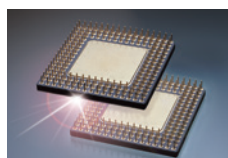

\* Conceptual illustration

\*1. Compared to the ZW-CE Series.



**Large logging capacity (up to 2 million values)**

## Mega Logging Memory

The memory capacity was greatly increased to log, process and store up to 2,000,000 values\*2 obtained by high-speed sampling.

\*2. Measurement values, emitted light amounts, or received light amounts can be logged.



# unmatched precision and speed



## High sensitivity

### High Sensitivity High Speed CMOS

The CMOS for the ZW-8000/7000 Series were optimized to measure any object more precisely, sensitively, and stably.

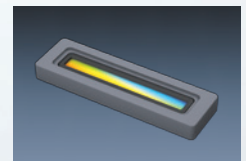

\* Conceptual illustration

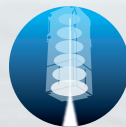

## Low aberration

### Advanced OCFL Module



The OCFL<sup>\*3</sup> module that controls the focal point for each wavelength of white light was further developed. Its multi-lens structure reduces aberration to 1/4<sup>\*4</sup> to provide stable, high-resolution measurements, without compromising its compact design.

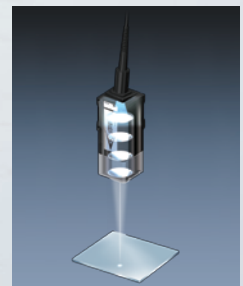

\* Conceptual illustration

\*3. OCFL: Omron Chromatic Focus Lens

\*4. Compared to the ZW-507/-520/-530/-540.

\* Advanced OCFL Module is also used for the ZW-5000 Series.

## Common technology throughout the entire series offering unsurpassed ease of integration



## Ultra-precise

**NEW**

### Ultra-precision machining and mechanical design

The ultra-precision machining technology and ultra-precision mechanical design minimize the housing while giving a lens diameter sufficient for high-precision measurements.

\* The ultra-precision machining technology and ultra-precision mechanical design are also used for the ZW-5000 Sensor Heads.



\* Conceptual illustration

## Technical explanation

# White light confocal principle to achieve stable

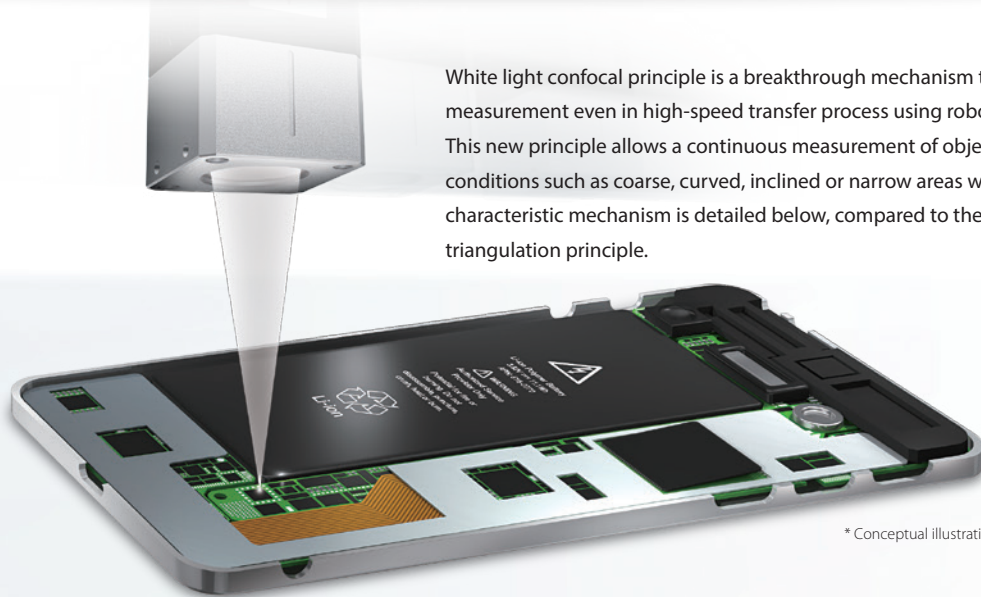

White light confocal principle is a breakthrough mechanism to enable a stable measurement even in high-speed transfer process using robots and stages. This new principle allows a continuous measurement of object in any mixed conditions such as coarse, curved, inclined or narrow areas while moving. Its characteristic mechanism is detailed below, compared to the traditional triangulation principle.

\* Conceptual illustration

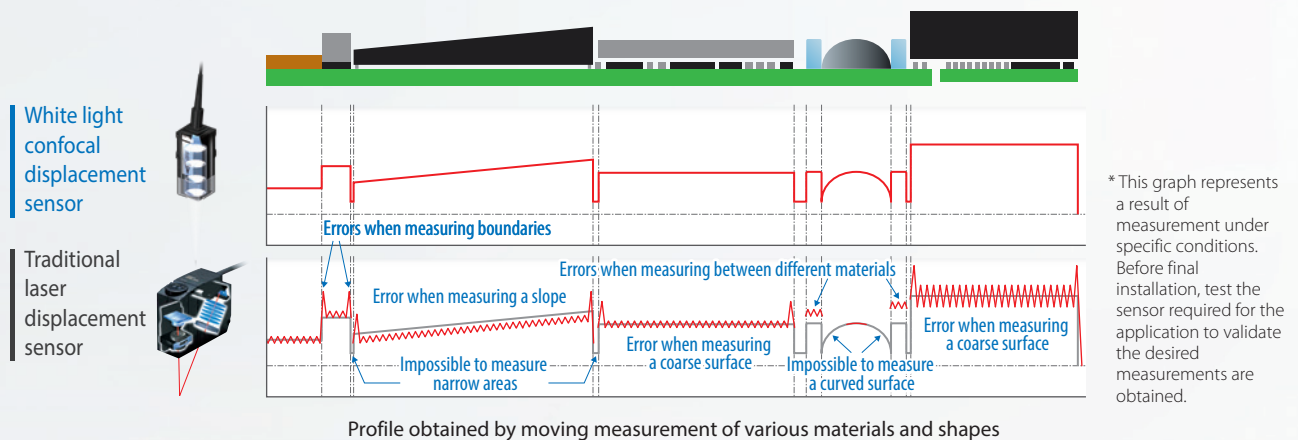

## Stable measurements of coarse surfaces

Only the light reflected from the measurement point enters the pinhole even if excessive light reflected from the object changes during movement. This enables stable and precise measurement without being affected by multiple reflection light.

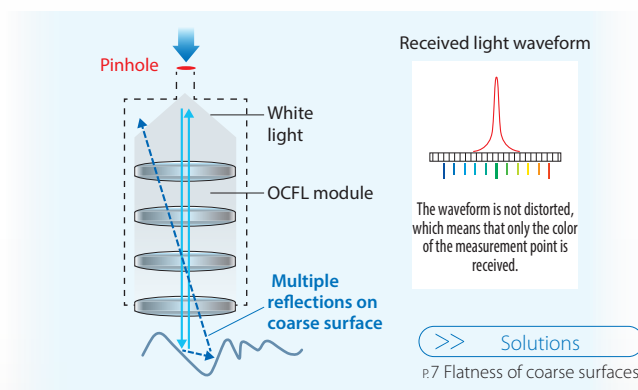

## Laser triangulation principle

Reflected light is received on a receiver, and height is measured from the waveform of light received on the receiver. The waveform is distorted due to the effect of excessive reflection, resulting in a measurement error. The effect of excessive reflection changes during movement, which causes unstable measurements.

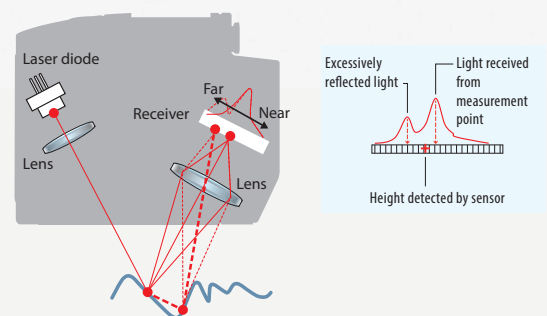

# measurements during movement

## High angle characteristic

Because light is emitted directly from above, the reflected light is not widely diffused. The sensor can measure by stably receiving a part of the reflected light.

**Curved surface**

Measures by receiving part of the light

Emitted light

Reflected light

Received light waveform

Stably receives light

>> Solutions

p.6 Mirror surfaces (inclined or curved surfaces)

The wavelength (position) can be obtained from a part of the received light even if the reflected light amount is reduced. This enables stable height measurements.

**Inclined surface**

Measures by receiving part of the light

Emitted light

Reflected light

Received light waveform

Stably receives light

### Laser triangulation principle

A laser spot beam is emitted obliquely from above. When the position of a glossy, regular-reflective object, where the beams are reflected in one direction, is shifted, the light reflected from the curved surface cannot be received.

**Curved surface**

No light received

Even if the light can be received, the received light waveform is distorted due to lens aberration as a result the measurement becomes unstable.

**Inclined surface**

Unstable

## Direction free

Stable measurement is not affected by the movement direction of objects or the sensor. This is achieved by emitting and receiving a cone-shaped beam of white light. This slim beam is also suitable for measurements in narrow areas.

Stably receives light

>> Solutions

p.10 No need to rotate the sensor

### Laser triangulation principle

The reflected light is detected obliquely from above. Depending on the installation direction, the sensor cannot measure the object because the reflected light is blocked.

No light received

## Selection

# Find the right controller and sensor head

### STEP1 Select controller based on measurement object and situation

Measure rattling or inclined  
“transparent objects or mirror  
surfaces” such as thin film  
sheets or glass



Ultra high-precision type  
**ZW-8000 Series**

Sensor Controller  
**ZW-8000T**



Measure accurate shapes of  
“coarse surfaces” while the  
sensor head is moving



Ultra high-speed type  
**ZW-7000 Series**

Sensor Controller  
**ZW-7000T**



Cost-effectively integrate stable  
and reliable measurement using  
the white light confocal principle  
into production lines







Standard type  
**ZW-5000 Series**

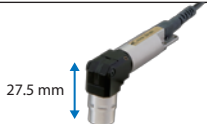
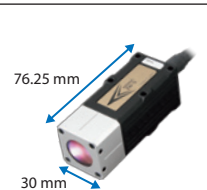

Sensor Controller  
**ZW-5000T**



**STEP2** Select head based on installation space

Width is limited		Pen-shaped straight type <b>ZW-SP80</b> □□
Height is limited		Pen-shaped right angle type <b>ZW-SPR80</b> □□
Precision is more important than space		Square-shaped straight type <b>ZW-S80</b> □□

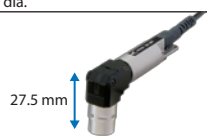
Width is limited		Pen-shaped straight type <b>ZW-SP70</b> □□
Height is limited		Pen-shaped right angle type <b>ZW-SPR70</b> □□
Precision is more important than space		Square-shaped straight type <b>ZW-S70</b> □□

Width is limited		Pen-shaped straight type <b>ZW-SP50</b> □□
Height is limited		Pen-shaped right angle type <b>ZW-SPR50</b> □□
Precision is more important than space		Square-shaped straight type <b>ZW-S50</b> □□

**STEP3** Select model based on distance

		Measuring range	Static resolution
Short	<b>ZW-SP8007</b>	7±0.3 mm	0.25 μm
Long	<b>ZW-SP8010</b>	10±0.7 mm	
Short	<b>ZW-SPR8007</b>	7±0.3 mm	
Long	<b>ZW-SPR8010</b>	10±0.7 mm	
Short	<b>ZW-S8010</b>	10±0.5 mm	
Long	<b>ZW-S8030</b>	30±2 mm	

		Measuring range	Static resolution
Short	<b>ZW-SP7007</b>	7±0.3 mm	0.25 μm
Long	<b>ZW-SP7010</b>	10±0.7 mm	
Short	<b>ZW-SPR7007</b>	7±0.3 mm	
Long	<b>ZW-SPR7010</b>	10±0.7 mm	
Short	<b>ZW-S7010</b>	10±0.5 mm	
Long	<b>ZW-S7040</b>	40±3 mm	

		Measuring range	Static resolution
Short	<b>ZW-SP5007</b>	7±0.3 mm	0.25 μm
Long	<b>ZW-SP5010</b>	10±0.7 mm	
Short	<b>ZW-SPR5007</b>	7±0.3 mm	
Long	<b>ZW-SPR5010</b>	10±0.7 mm	
Short	<b>ZW-S5010</b>	10±0.5 mm	
Long	<b>ZW-S5030</b>	30±2 mm	

The sensor controller is compatible with sensor heads. When the sensor head is broken, replace only the broken sensor head, instead of both the sensor head and controller, and connect a new head to the existing controller.

**Patented**  
Calibration ROM ensures compatibility and precision

## Application

# ZW Series for a variety of applications

### Smart phone (component process)

Parallelism measurement between parts before module part assembly



Parallelism measurement between parts before module part assembly



Groove measurement of camera modules



Nozzle gap inspection during resin application



Gap inspection after module part assembly

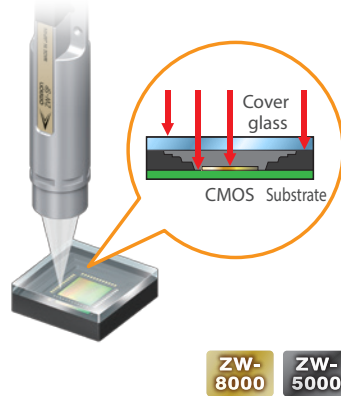

Flatness measurement of cover glass



### Smart phone (assembly process)

Height measurement of assembled parts



Case width measurement

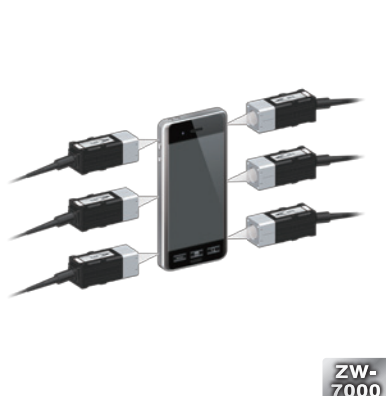

Level difference measurement between buttons and case

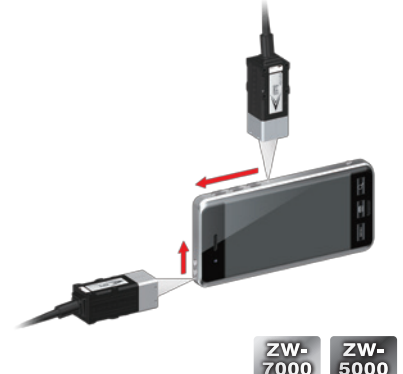

Note: The most suitable model will vary depending on the object material and surface.  
 Before final installation, test the sensor required for the application to validate the desired measurements are obtained.

Level measurement of cases

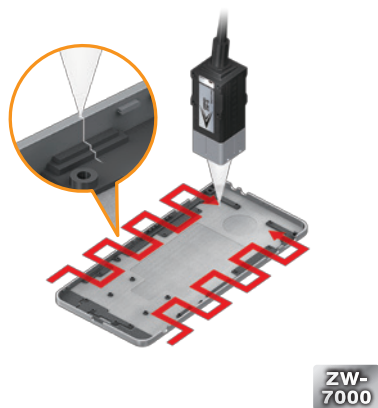

ZW-7000

Thickness measurement of battery sheets

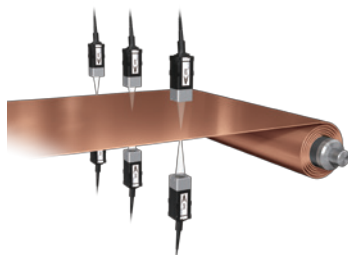

ZW-7000

LED potting shape measurement

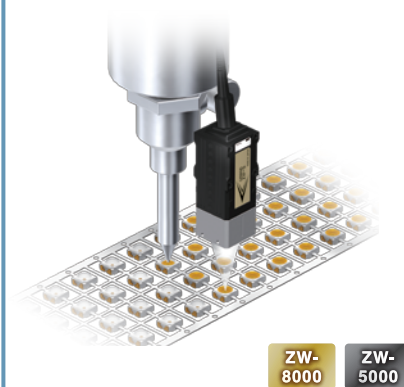

ZW-8000 ZW-5000

Flatness measurement of cases

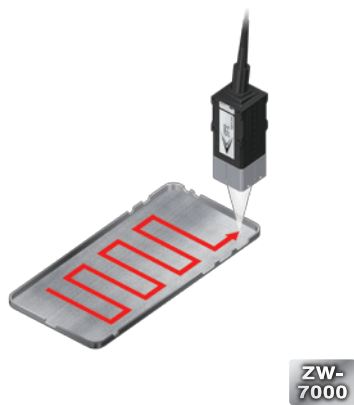

ZW-7000

Flatness measurement of batteries



ZW-7000

Coplanarity measurement of connector pins

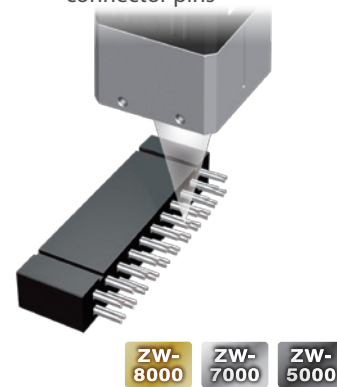

ZW-8000 ZW-7000 ZW-5000

Level difference measurement of logos



ZW-7000 ZW-5000

## SEMI/FPD

Abrasion profile measurement of target material

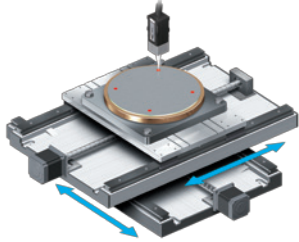

ZW-7000

Height measurement of wafers

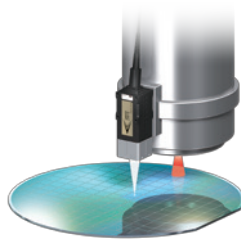

ZW-8000 ZW-5000

Gap measurement of electronic chips

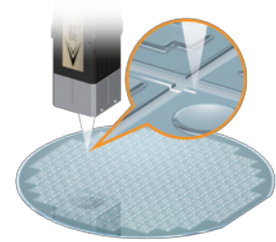

ZW-8000 ZW-5000

Z axis adjustment of chip mounter



ZW-7000

Profile measurement of solder on substrates

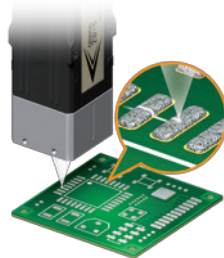

ZW-8000 ZW-5000

Profile measurement of silicon

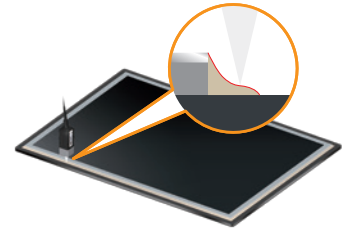

ZW-8000 ZW-5000

## Automotive parts

Inner diameter measurement



ZW-7000

Profile inspection of sealing materials for assembled parts

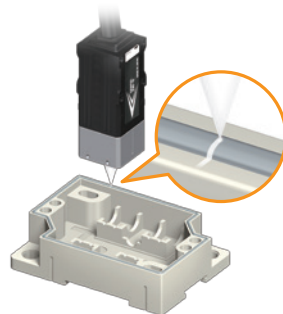

ZW-5000

Operation inspection of relay contacts

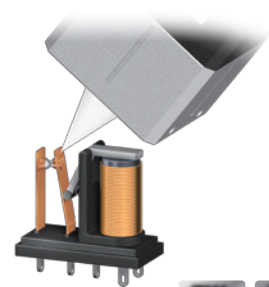

ZW-7000 ZW-5000

Surface deflection and flatness measurement of rotary parts

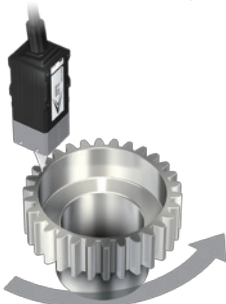

ZW-7000

Depth measurement of holes on metal components

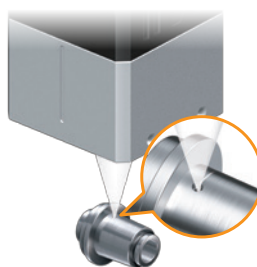

ZW-7000

Profile inspection of friction materials for clutches

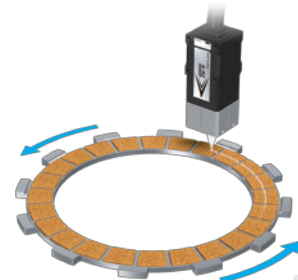

ZW-7000



## Pharmaceuticals

Glass thickness measurement on rollers

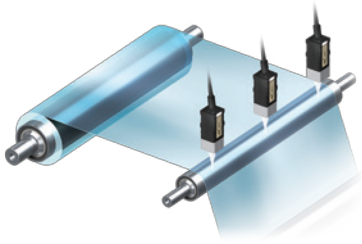

ZW-8000 ZW-5000

Thickness measurement of lenses

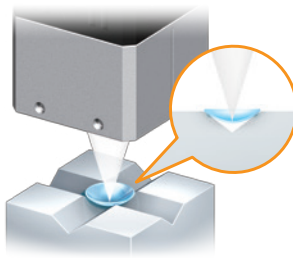

ZW-8000 ZW-5000

Liquid level measurement in small-diameter vessels



ZW-5000

Position inspection of film lamination

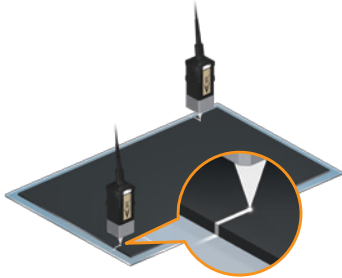

ZW-8000 ZW-5000

Assembly measurement of ECU boards

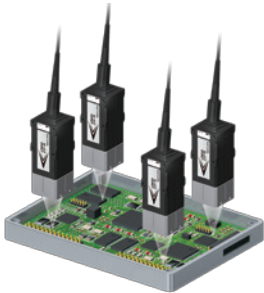

ZW-7000

Curvature measurement of glass surfaces

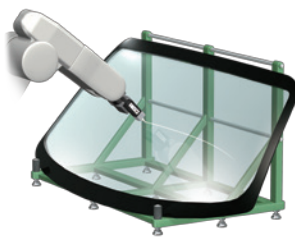

ZW-7000

Thickness measurement of motor cores



ZW-7000

Eccentricity measurement of motors



ZW-7000



# Confocal Fiber Displacement Sensor

# ZW-8000/7000/5000 Series

## Reliable measurements for any material and surface types



- Measuring shiny objects with an inclination of  $\pm 25^\circ$
- $\pm 0.3 \mu\text{m}$  or less linearity for various materials
- Sampling rate as fast as  $20 \mu\text{s}$
- Small spot diameter of  $4 \mu\text{m}$  or less

Note: Angle characteristic, linearity, sampling period and spot diameter given in the cover differ among models. Please ask OMRON sales representative for details.



## System Configuration

### EtherCAT connections

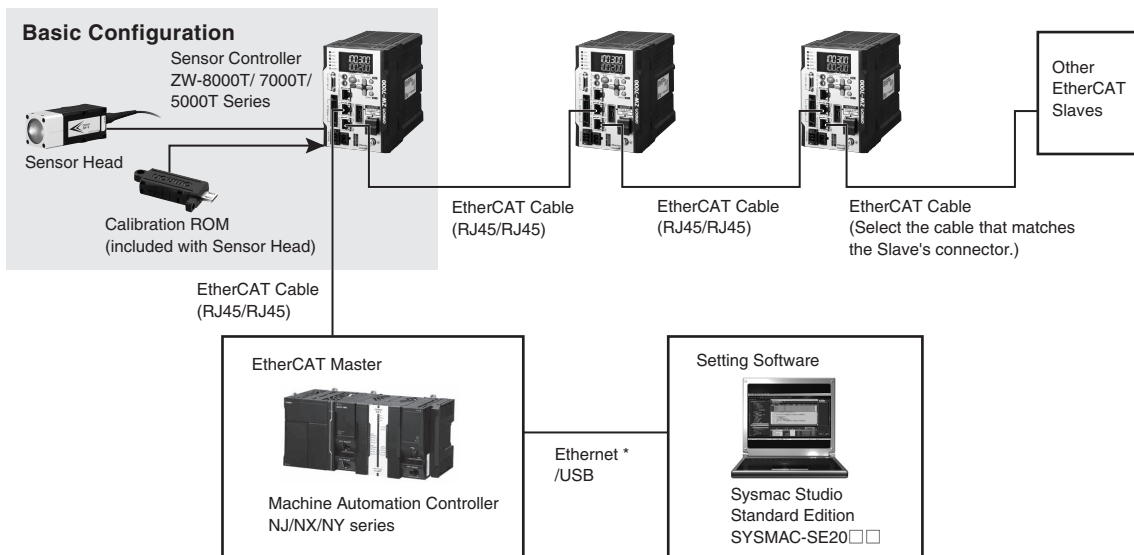

### Analog, EtherNet/IP, Ethernet, RS-232C and Parallel connections

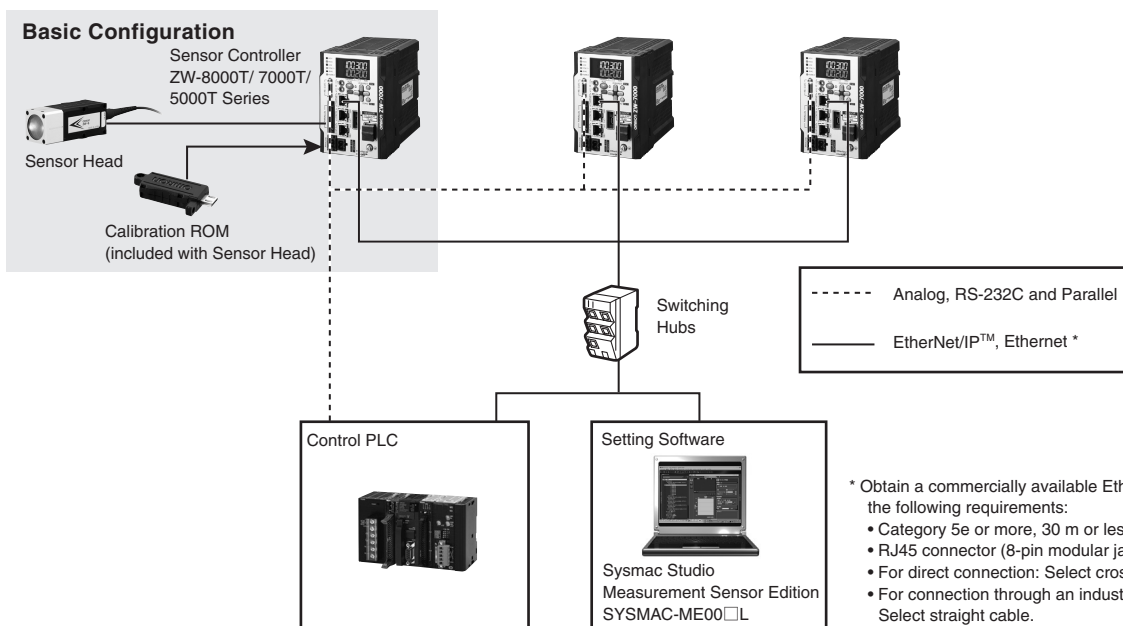

\* Obtain a commercially available Ethernet cable satisfying the following requirements:

- Category 5e or more, 30 m or less
- RJ45 connector (8-pin modular jack)
- For direct connection: Select cross cable.
- For connection through an industrial switching hub: Select straight cable.

# ZW-8000/7000/5000 Series

## Order Information

### ZW-8000

#### ●Sensor Head

#### Square-shaped straight type

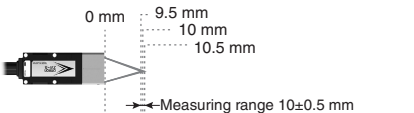
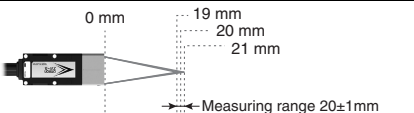
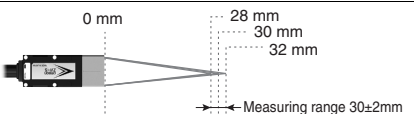
Appearance	Measuring range	Spot diameter	Static resolution *	Cable length	Model
	 0 mm, 9.5 mm, 10 mm, 10.5 mm ← Measuring range 10±0.5 mm	4 μm dia.	0.25 μm	2 m	ZW-S8010 2M
				0.3 m	ZW-S8010 0.3M
	 0 mm, 19 mm, 20 mm, 21 mm ← Measuring range 20±1mm	7 μm dia.	0.25 μm	2 m	ZW-S8020 2M
				0.3 m	ZW-S8020 0.3M
	 0 mm, 28 mm, 30 mm, 32 mm ← Measuring range 30±2mm	10 μm dia.	0.25 μm	2 m	ZW-S8030 2M
				0.3 m	ZW-S8030 0.3M

\* Values when the Sensor Controller ZW-8000T is used.

#### Pen-shaped straight type

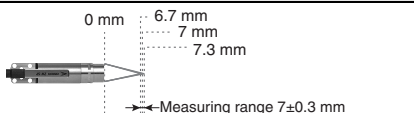
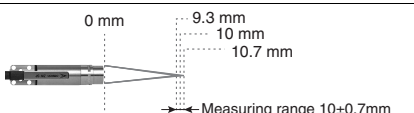
Appearance	Measuring range	Spot diameter	Static resolution *	Cable length	Model
	 0 mm, 6.7 mm, 7 mm, 7.3 mm ← Measuring range 7±0.3 mm	7 μm dia.	0.25 μm	2 m	ZW-SP8007 2M
				0.3 m	ZW-SP8007 0.3M
	 0 mm, 9.3 mm, 10 mm, 10.7 mm ← Measuring range 10±0.7mm	10 μm dia.	0.25 μm	2 m	ZW-SP8010 2M
				0.3 m	ZW-SP8010 0.3M

\* Values when the Sensor Controller ZW-8000T is used.

#### Pen-shaped right angle type

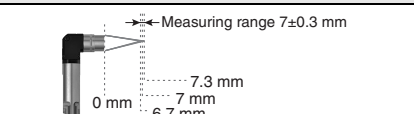
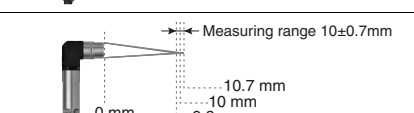

Appearance	Measuring range	Spot diameter	Static resolution *	Cable length	Model
	 ← Measuring range 7±0.3 mm 0 mm, 7.3 mm, 7 mm, 6.7 mm	8 μm dia.	0.25 μm	2 m	ZW-SPR8007 2M
				0.3 m	ZW-SPR8007 0.3M
	 ← Measuring range 10±0.7mm 0 mm, 10.7 mm, 10 mm, 9.3 mm	11 μm dia.	0.25 μm	2 m	ZW-SPR8010 2M
				0.3 m	ZW-SPR8010 0.3M

\* Values when the Sensor Controller ZW-8000T is used.

#### ●Sensor Controller with EtherCAT

Appearance	Power supply	Output type	Model
	24 VDC	NPN/PNP	ZW-8000T

#### ●Cable

Appearance	Item	Cable length	Model
	Extension Fiber Cable (from Sensor Head to Sensor Controller), (Fiber Adapter ZW-XFCS is included)	2 m	ZW-XF8002R
		5 m	ZW-XF8005R
		10 m	ZW-XF8010R
		20 m	ZW-XF8020R
		30 m	ZW-XF8030R
	Fiber Adapter (used between Sensor Head pre-wired cable and Extension Fiber Cable)	—	ZW-XFCS

**Note:** Extension Fiber Cable ZW-XF80□□R can be used with the firmware version 3.000 or later. If you have an old version Sensor Controller, register as a Sysmac member and download the latest firmware and tools to update your Sensor Controller. Refer to the Sysmac member registration sheet that is enclosed with the Sensor Controller for details on member registration and firmware download.

**ZW-7000**

● **Sensor Head**

**Square-shaped straight type**

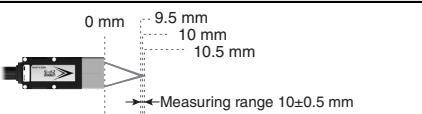
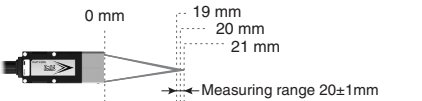
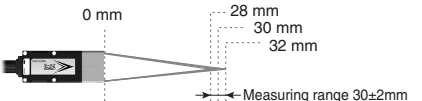
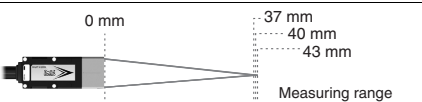
Appearance	Measuring range	Spot diameter	Static resolution *	Cable length	Model
	 0 mm, 9.5 mm, 10 mm, 10.5 mm Measuring range 10±0.5 mm	50 μm dia.	0.25 μm	2 m	ZW-S7010 2M
				0.3 m	ZW-S7010 0.3M
	 0 mm, 19 mm, 20 mm, 21 mm Measuring range 20±1mm	70 μm dia.	0.25 μm	2 m	ZW-S7020 2M
				0.3 m	ZW-S7020 0.3M
	 0 mm, 28 mm, 30 mm, 32 mm Measuring range 30±2mm	100 μm dia.	0.25 μm	2 m	ZW-S7030 2M
				0.3 m	ZW-S7030 0.3M
	 0 mm, 37 mm, 40 mm, 43 mm Measuring range 40±3mm	120 μm dia.	0.25 μm	2m	ZW-S7040 2M
				0.3m	ZW-S7040 0.3M

\* Values when the Sensor Controller ZW-7000T is used.

**Pen-shaped straight type**

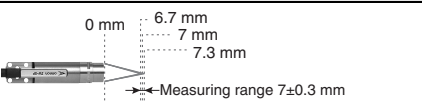
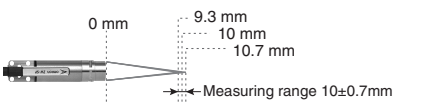
Appearance	Measuring range	Spot diameter	Static resolution *	Cable length	Model
	 0 mm, 6.7 mm, 7 mm, 7.3 mm Measuring range 7±0.3 mm	130 μm dia.	0.25 μm	2 m	ZW-SP7007 2M
				0.3 m	ZW-SP7007 0.3M
	 0 mm, 9.3 mm, 10 mm, 10.7 mm Measuring range 10±0.7mm	170 μm dia.	0.25 μm	2 m	ZW-SP7010 2M
				0.3 m	ZW-SP7010 0.3M

\* Values when the Sensor Controller ZW-7000T is used.

**Pen-shaped right angle type**

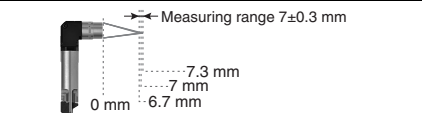
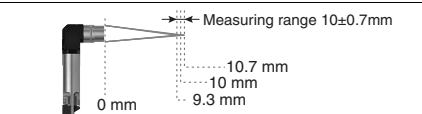

Appearance	Measuring range	Spot diameter	Static resolution *	Cable length	Model
	 Measuring range 7±0.3 mm 0 mm, 7.3 mm, 7 mm, 6.7 mm	150 μm dia.	0.25 μm	2 m	ZW-SPR7007 2M
				0.3 m	ZW-SPR7007 0.3M
	 Measuring range 10±0.7mm 0 mm, 10.7 mm, 10 mm, 9.3 mm	190 μm dia.	0.25 μm	2 m	ZW-SPR7010 2M
				0.3 m	ZW-SPR7010 0.3M

\* Values when the Sensor Controller ZW-7000T is used.

● **Sensor Controller with EtherCAT**

Appearance	Power supply	Output type	Model
	24 VDC	NPN/PNP	ZW-7000T

● **Cable**

Appearance	Item	Cable length	Model
	Extension Fiber Cable (from Sensor Head to Sensor Controller), (Fiber Adapter ZW-XFCM is included)	2 m	ZW-XF7002R
		5 m	ZW-XF7005R
		10 m	ZW-XF7010R
		20 m	ZW-XF7020R
	Fiber Adapter (used between Sensor Head pre-wired cable and Extension Fiber Cable)	30 m	ZW-XF7030R
		—	ZW-XFCM

**Note:** Cables of 10, 20, and 30 m can be used with the firmware version 2.100 or later. If you have an old version Sensor Controller, register as a Sysmac member and download the latest firmware and tools to update your Sensor Controller. Refer to the Sysmac member registration sheet that is enclosed with the Sensor Controller for details on member registration and firmware download.

# ZW-8000/7000/5000 Series

## ZW-5000

### ●Sensor Head

#### Square-shaped straight type

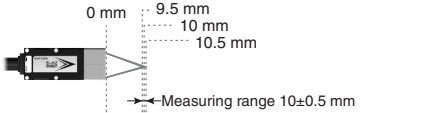
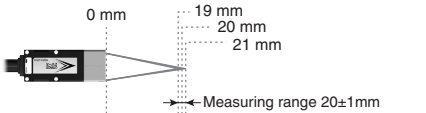
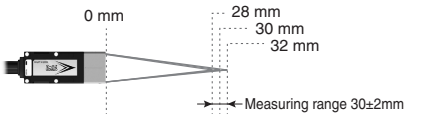
Appearance	Measuring range	Spot diameter	Static resolution *	Cable length	Model
	 0 mm, 9.5 mm, 10 mm, 10.5 mm Measuring range 10±0.5 mm	9 μm dia.	0.25 μm	2 m	ZW-S5010 2M
				0.3 m	ZW-S5010 0.3M
	 0 mm, 19 mm, 20 mm, 21 mm Measuring range 20±1mm	13 μm dia.	0.25 μm	2 m	ZW-S5020 2M
				0.3 m	ZW-S5020 0.3M
	 0 mm, 28 mm, 30 mm, 32 mm Measuring range 30±2mm	18 μm dia.	0.25 μm	2 m	ZW-S5030 2M
				0.3 m	ZW-S5030 0.3M

\* Values when the Sensor Controller ZW-5000T is used.

#### Pen-shaped straight type

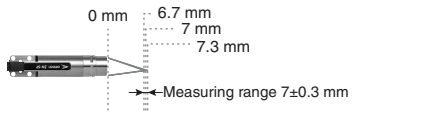
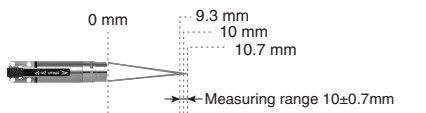
Appearance	Measuring range	Spot diameter	Static resolution *	Cable length	Model
	 0 mm, 6.7 mm, 7 mm, 7.3 mm Measuring range 7±0.3 mm	13 μm dia.	0.25 μm	2 m	ZW-SP5007 2M
				0.3 m	ZW-SP5007 0.3M
	 0 mm, 9.3 mm, 10 mm, 10.7 mm Measuring range 10±0.7mm	18 μm dia.	0.25 μm	2 m	ZW-SP5010 2M
				0.3 m	ZW-SP5010 0.3M

\* Values when the Sensor Controller ZW-5000T is used.

#### Pen-shaped right angle type

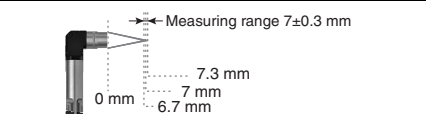
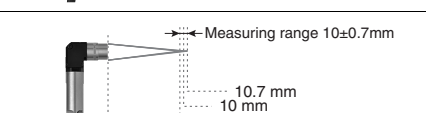

Appearance	Measuring range	Spot diameter	Static resolution *	Cable length	Model
	 Measuring range 7±0.3 mm 0 mm, 7.3 mm, 7 mm, 6.7 mm	15 μm dia.	0.25 μm	2 m	ZW-SPR5007 2M
				0.3 m	ZW-SPR5007 0.3M
	 Measuring range 10±0.7mm 0 mm, 10.7 mm, 10 mm, 9.3 mm	20 μm dia.	0.25 μm	2 m	ZW-SPR5010 2M
				0.3 m	ZW-SPR5010 0.3M

\* Values when the Sensor Controller ZW-5000T is used.

### ●Sensor Controller with EtherCAT

Appearance	Power supply	Output type	Model
	24 VDC	NPN/PNP	ZW-5000T

### ●Cable

Appearance	Item	Cable length	Model
	Extension Fiber Cable (from Sensor Head to Sensor Controller), (Fiber Adapter ZW-XFC2 is included)	2 m	ZW-XF5002R
		5 m	ZW-XF5005R
		10 m	ZW-XF5010R
		20 m	ZW-XF5020R
		30 m	ZW-XF5030R
	Fiber Adapter (used between Sensor Head pre-wired cable and Extension Fiber Cable)	—	ZW-XFC2

**Note:** Extension Fiber Cable ZW-XF50□□R can be used with the firmware version 2.100 or later. If you have an old version Sensor Controller, register as a Sysmac member and download the latest firmware and tools to update your Sensor Controller. Refer to the Sysmac member registration sheet that is enclosed with the Sensor Controller for details on member registration and firmware download.

●Common cables

Appearance	Item	Cable length	Model
	Parallel caable for ZW-8000T/7000T/5000T 32-pole (included with Sensor Controller ZW-8000T/7000T/5000T)	2 m	ZW-XCP2E
	RS-232C Cable for personal computer	2 m	ZW-XRS2
	RS-232C Cable for PLC/programmable terminal	2 m	ZW-XPT2

●Recommended EtherCAT Communications Cables

Use Straight STP (shielded twisted-pair) cable of category 5 or higher with double shielding (braiding and aluminum foil tape) for EtherCAT.

●Cable with Connectors

Item	Appearance	Recommended manufacturer	Cable length(m) *1	Model
Standard type Cable with Connectors on Both Ends (RJ45/RJ45) Wire Gauge and Number of Pairs: AWG26, 4-pair Cable Cable Sheath material: LSZH *2 Cable color: Yellow *3		OMRON	0.3	XS6W-6LSZH8SS30CM-Y
			0.5	XS6W-6LSZH8SS50CM-Y
			1	XS6W-6LSZH8SS100CM-Y
			2	XS6W-6LSZH8SS200CM-Y
			3	XS6W-6LSZH8SS300CM-Y
			5	XS6W-6LSZH8SS500CM-Y
Rugged type Cable with Connectors on Both Ends (RJ45/RJ45) Wire Gauge and Number of Pairs: AWG22, 2-pair Cable		OMRON	0.3	XS5W-T421-AMD-K
			0.5	XS5W-T421-BMD-K
			1	XS5W-T421-CMD-K
			2	XS5W-T421-DMD-K
			5	XS5W-T421-GMD-K
			10	XS5W-T421-JMD-K
Rugged type Cable with Connectors on Both Ends (M12 Straight/RJ45) Wire Gauge and Number of Pairs: AWG22, 2-pair Cable		OMRON	0.3	XS5W-T421-AMC-K
			0.5	XS5W-T421-BMC-K
			1	XS5W-T421-CMC-K
			2	XS5W-T421-DMC-K
			5	XS5W-T421-GMC-K
			10	XS5W-T421-JMC-K
Rugged type Cable with Connectors on Both Ends (M12 Right-angle/RJ45) Wire Gauge and Number of Pairs: AWG22, 2-pair Cable		OMRON	0.3	XS5W-T422-AMC-K
			0.5	XS5W-T422-BMC-K
			1	XS5W-T422-CMC-K
			2	XS5W-T422-DMC-K
			5	XS5W-T422-GMC-K
			10	XS5W-T422-JMC-K

Note: For details, refer to Cat.No.G019.

\*1. Standard type cables length 0.2, 0.3, 0.5, 1, 1.5, 2, 3, 5, 7.5, 10, 15 and 20m are available.

Rugged type cables length 0.3, 0.5, 1, 2, 3, 5, 10 and 15m are available.

\*2. The lineup features Low Smoke Zero Halogen cables for in-cabinet use and PUR cables for out-of-cabinet use.

\*3. Cables colors are available in blue, yellow, or Green

●Cables / Connectors

Wire Gauge and Number of Pairs: AWG24, 4-pair Cable

Item	Appearance	Recommended manufacturer	Model
Cables	—	Hitachi Metals, Ltd.	NETSTAR-C5E SAB 0.5 × 4P CP *
	—	Kuramo Electric Co.	KETH-SB *
	—	SWCC Showa Cable Systems Co.	FAE-5004 *
RJ45 Connectors	—	Panduit Corporation	MPS588-C *

\* We recommend to use above cable and connector together.

Wire Gauge and Number of Pairs: AWG22, 2-pair Cable



Item	Appearance	Recommended manufacturer	Model
Cables	—	Kuramo Electric Co.	KETH-PSB-OMR *
	—	JMACS Japan Co.,Ltd.	PNET/B *
RJ45 Assembly Connector		OMRON	XS6G-T421-1 *

Note: Connect both ends of cable shielded wires to the connector hoods.

\* We recommend to use above cable and connector together.



## ZW-8000/7000/5000 Series

### ●Industrial switching hubs for Ethernet

Appearance	Number of ports	Failure detection	Current consumption	Model
	3	None	0.22A	W4S1-03B
	5	None	0.22A	W4S1-05B
		Supported		W4S1-05C

**Note:** Industrial switching hubs are cannot be used for EtherCAT.

### ●EtherCAT junction slaves

Appearance	Number of ports	Power supply voltage	Current consumption	Model
	3	20.4 to 28.8 VDC (24 VDC -15 to 20%)	0.08A	GX-JC03
	6		0.17A	GX-JC06

**Note:** 1. Please do not connect EtherCAT junction slave with OMRON position control unit, Model CJ1W-NC□81/□82.  
2. EtherCAT junction slaves cannot be used for EtherNet/IP™ and Ethernet.

### ●Automation Software Sysmac Studio

**Please purchase a DVD and required number of licenses the first time you purchase the Sysmac Studio. DVDs and licenses are available individually.**

**Each model of licenses does not include DVD.**

Item	Specifications	Number of licenses		Media	Model	Standards
		Number of licenses	Media			
Sysmac Studio Standard Edition Ver.1□□ *2	The Sysmac Studio is the software that provides an integrated environment for setting, programming, debugging and maintenance of machine automation controllers including the NJ/NX-series CPU Units, NY-series Industrial PC, EtherCat Slave, and the HMI. Sysmac Studio runs on the following OS. Windows 7 (32-bit/64-bit version)/Windows 8 (32-bit/64-bit version)/Windows 8.1 (32-bit/64-bit version)/Windows 10 (32-bit/64-bit version) This software provides functions of the Measurement Sensor Edition. Refer to your OMRON website for details.	— (Media only)	DVD		SYSMAC-SE200D	—
		1 license*1	—		SYSMAC-SE201L	—
Sysmac Studio Measurement Sensor Edition Ver.1.□□	Sysmac Studio Measurement Sensor Edition is a limited license that provides selected functions required for ZW-series Displacement Sensor settings. Because this product is a license only, you need the Sysmac Standard Edition DVD media to install it.	1 license	—		SYSMAC-ME001L	—
		3 license	—		SYSMAC-ME003L	—

\*1. Multiple licenses are available for the Sysmac Studio (3, 10, 30, or 50 licenses).

\*2. ZW-8000/7000/5000 is supported by Sysmac Studio version 1.22 or higher.

### ●Fiber Cleaner

Item	Recommended manufacturer	Model	Applicable Model			Contacts
			ZW-8000	ZW-7000	ZW-5000	
Fiber Connector Cleaner *1	OMRON	ZW-XCL	Yes	Yes	Yes	OMRON
NEOCLEAN-M	NTT Advanced Technology Corporation	ATC-NE-M1	No	Yes	No	*2
OPTIPOP R1		ATC-RE-01	Yes (Sensor Head only)	No	Yes (Sensor Head only)	

\*1. Place orders in units of boxes (contacting 10 units).

\*2. Contacts

[Request for an Estimate]

[http://www.ntt-at.com/product/optical\\_cleaner/Distributors.html](http://www.ntt-at.com/product/optical_cleaner/Distributors.html)

[Request for Information]

NTT Advanced Technology Corporation

Muza Kawasaki Central Tower, 1310 Omiya-cho Saiwai-ku, Kawasaki-shi, Kanagawa, 212-0014, Japan

TEL: +81 44 589 5894

[http://www.ntt-at.com/product/optical\\_cleaner/](http://www.ntt-at.com/product/optical_cleaner/)



## Specifications

### ● Sensor Head

ZW-S8010/S8020/S8030/SP8007/SP8010/SPR8007/SPR8010

Item	Specifications						
	ZW-S8010	ZW-S8020	ZW-S8030	ZW-SP8007	ZW-SP8010	ZW-SPR8007	ZW-SPR8010
Sensor controller	ZW-8000T						
Sensor head type	Square-shaped straight type			Pen-shaped straight type		Pen-shaped right angle type	
Measurement center distance *1	10 mm	20 mm	30 mm	7 mm	10 mm	7 mm	10 mm
Measuring range *2	±0.5 mm	±1mm	±2mm	±0.3 mm	±0.7 mm	±0.3 mm	±0.7 mm
Static resolution *3	0.25 μm						
Linearity *4	±0.3 μm	±0.6 μm	±1.3 μm	±0.3 μm	±0.45 μm	±0.45 μm	±0.7 μm
Spot diameter (Total measurement range) *5	4 μm dia.	7 μm dia.	10 μm dia.	7 μm dia.	10 μm dia.	8 μm dia.	11 μm dia.
Measurement cycle *6	60 μs to 7,500 μs						
Operating ambient illumination	Illumination on object surface max.30000 Lx: (incandescent light)						
Ambient temperature range	Operation: 0 to 50°C, Storage: -15 to +60°C (No freezing and condensation)						
Ambient humidity range	Operation/storage: 35 or 85%RH (No condensation)						
Degree of protection	IP40 (IEC60529)						
Vibration resistance (destructive)	10 to 150 Hz (half amplitude 0.35 mm), 80 mins in each of X/Y/Z directions						
Shock resistance (destructive)	150 m/s <sup>2</sup> , 6 direction, 3 times each (up/down, left/right, forward/backward)						
Temperature characteristic *7	0.6 μm/°C (0.2 μm/°C)	1.1 μm/°C (0.5 μm/°C)	1.8 μm/°C (1.0 μm/°C)	0.8 μm/°C (0.4 μm/°C)	0.8 μm/°C (0.4 μm/°C)	0.8 μm/°C (0.4 μm/°C)	0.8 μm/°C (0.4 μm/°C)
LED Safety	Risk Group 1 (IEC62471)						
LASER safety	Class1 (IEC/EN60825-1)						
Material	Chassis: aluminum die cast Fiber cable sheath: PVC Calibration ROM: PC			Chassis: SUS Fiber cable sheath: PVC Calibration ROM: PC Mounting Plate: Aluminum		Chassis: SUS, aluminum Fiber cable sheath: PVC Calibration ROM: PC Mounting Plate: Aluminum	
Fiber cable length	0.3 m, 2 m (flex-resistant cable)						
Fiber cable minimum bend radius	20 mm						
Insulation resistance (Calibration ROM)	Between case and all terminals: 20 MΩ (by 250 VDC)						
Dielectric strength (Calibration ROM)	Between case and all terminals: 1000 VAC, 50/60 Hz, 1 min						
Weight	Fiber cable length 0.3m Approx. 170g Fiber cable length 2m Approx. 180g			Fiber cable length 0.3m Approx. 27 g Fiber cable length 2m Approx. 37 g		Fiber cable length 0.3m Approx. 31 g Fiber cable length 2m Approx. 41 g	
Accessories	Calibration ROM fixing screw (M2×5mm) × 1, Fiber cable protective cap × 1, Strap × 1, Instruction Manual, Precautions			Installation plate × 1, Unit fixing screws (M2 × 10 mm) × 4, Calibration ROM fixing screw (M2 × 5 mm) × 1, Fiber cable protective cap × 1, Strap × 1, Instruction Manual, Precautions			

\*1. Indicates the distance from the front of the sensor head. The pen-shaped right angle type has a maximum individual difference of ±0.15 mm in the distance from the front of the sensor head.

\*2. The measurement range is higher 100 μs than measurement cycle.

\*3. Capacity value when OMRON standard mirror surface target is measured at the measurement center distance as the average of 16,384 times. The value when the Sensor Controller ZW-8000T is connected.

\*4. Material setting for the OMRON standard mirror surface target: Error from an ideal straight line when measuring on mirror surface.

\*5. Capacity value defined by  $1/e^2$  (13.5%) of the peak optical intensity of the measurement wavelength.

\*6. When an extension fiber cable of 2 m or longer is connected, the setting range of the measurement cycle (exposure time) changes. For details, refer to *Setting Measurement Cycle* in the *ZW-8000/7000/5000 User's Manual (Cat. No. Z362)*.

\*7. Actual value of the change in measurement value at the measurement center distance when fastened with an aluminum jig between the Sensor Head and the target, and with the Sensor Head and the Sensor Controller set in the same temperature environment.

The value in parentheses is the actual value when using an SUS304 jig.

When measuring the thickness, the value is calculated from the difference between the heights of the surface and rear surface, so there is no effect on the temperature change.

# ZW-8000/7000/5000 Series

## ZW-S7010/S7020/S7030/S7040/SP7007/SP7010/SPR7007/SPR7010

Item	Specifications							
	ZW-S7010	ZW-S7020	ZW-S7030	ZW-S7040	ZW-SP7007	ZW-SP7010	ZW-SPR7007	ZW-SPR7010
Sensor controller	ZW-7000T							
Sensor head type	Square-shaped straight type				Pen-shaped straight type		Pen-shaped right angle type	
Measurement center distance *1	10 mm	20 mm	30 mm	40 mm	7 mm	10 mm	7 mm	10 mm
Measuring range *2	±0.5 mm	±1 mm	±2 mm	±3 mm	±0.3 mm	±0.7 mm	±0.3 mm	±0.7 mm
Static resolution *3	0.25 μm							
Linearity *4	±0.45 μm	±0.9 μm	±2.0 μm	±3.0 μm	±0.45 μm	±0.7 μm	±0.7 μm	±1.1 μm
Spot diameter (Total measurement range) *5	50 μm dia.	70 μm dia.	100 μm dia.	120 μm dia.	130 μm dia.	170 μm dia.	150 μm dia.	190 μm dia.
Measurement cycle *6	20 μs to 400 μs							
Operating ambient illumination	Illumination on object surface max.30000 Lx: (incandescent light)							
Ambient temperature range	Operation: 0 to 50°C, Storage: -15 to +60°C (No freezing and condensation)							
Ambient humidity range	Operation/storage: 35 or 85%RH (No condensation)							
Degree of protection	IP40 (IEC60529)							
Vibration resistance (destructive)	10 to 150 Hz (half amplitude 0.35 mm), 80 mins in each of X/Y/Z directions							
Shock resistance (destructive)	150 m/s <sup>2</sup> , 6 direction, 3 times each (up/down, left/right, forward/backward)							
Temperature characteristic *7	0.6 μm/°C (0.2 μm/°C)	1.1 μm/°C (0.5 μm/°C)	1.8 μm/°C (1.0 μm/°C)	2.1 μm/°C (1.2 μm/°C)	0.8 μm/°C (0.4 μm/°C)	0.8 μm/°C (0.4 μm/°C)	0.8 μm/°C (0.4 μm/°C)	0.8 μm/°C (0.4 μm/°C)
LED Safety	Risk Group 1 (IEC62471)							
Material	Chassis: aluminum die cast Fiber cable sheath: PVC Calibration ROM: PC				Chassis: SUS Fiber cable sheath: PVC Calibration ROM: PC Mounting Plate: Aluminum		Chassis: SUS, aluminum Fiber cable sheath: PVC Calibration ROM: PC Mounting Plate: Aluminum	
Fiber cable length	0.3 m, 2 m (flex-resistant cable)							
Fiber cable minimum bend radius	20 mm							
Insulation resistance (Calibration ROM)	Between case and all terminals: 20 MΩ (by 250 VDC)							
Dielectric strength (Calibration ROM)	Between case and all terminals: 1000 VAC, 50/60 Hz, 1 min							
Weight	Fiber cable length 0.3m Approx. 170g Fiber cable length 2m Approx. 180g				Fiber cable length 0.3m Approx. 27 g Fiber cable length 2m Approx. 37 g		Fiber cable length 0.3m Approx. 31 g Fiber cable length 2m Approx. 41 g	
Accessories	Calibration ROM fixing screw (M2×5mm) × 1, Fiber cable protective cap × 1, Strap × 2, Instruction Manual, Precautions				Installation plate × 1, Unit fixing screws (M2 × 10 mm) × 4, Calibration ROM fixing screw (M2 × 5 mm) × 1, Fiber cable protective cap × 1, Strap × 2, Instruction Manual, Precautions			

\*1. Indicates the distance from the front of the sensor head. The pen-shaped right angle type has a maximum individual difference of ±0.15 mm in the distance from the front of the sensor head.

\*2. The measurement range is higher 28 μs than measurement cycle.

\*3. Capacity value when OMRON standard mirror surface target is measured at the measurement center distance as the average of 16,384 times.  
The value when the Sensor Controller ZW-7000T is connected.

\*4. Material setting for the OMRON standard mirror surface target: Error from an ideal straight line when measuring on mirror surface.

\*5. Capacity value defined by 1/e<sup>2</sup> (13.5%) of the peak optical intensity of the measurement wavelength.

\*6. When an extension fiber cable of 10 m or longer is connected, the setting range of the measurement cycle (exposure time) changes. For details, refer to *Setting Measurement Cycle* in the *ZW-8000/7000/5000 User's Manual (Cat. No. Z362)*.

\*7. Actual value of the change in measurement value at the measurement center distance when fastened with an aluminum jig between the Sensor Head and the target, and with the Sensor Head and the Sensor Controller set in the same temperature environment.

The value in parentheses is the actual value when using an SUS304 jig.

When measuring the thickness, the value is calculated from the difference between the heights of the surface and rear surface, so there is no effect on the temperature change.

## ZW-S5010/S5020/S5030/SP5007/SP5010/SPR5007/SPR5010

Item	Specifications						
	ZW-S5010	ZW-S5020	ZW-S5030	ZW-SP5007	ZW-SP5010	ZW-SPR5007	ZW-SPR5010
Sensor controller	ZW-5000T						
Sensor head type	Square-shaped straight type			Pen-shaped straight type		Pen-shaped right angle type	
Measurement center distance *1	10 mm	20 mm	30 mm	7 mm	10 mm	7 mm	10 mm
Measuring range	±0.5 mm	±1 mm	±2 mm	±0.3 mm	±0.7 mm	±0.3 mm	±0.7 mm
Static resolution *2	0.25 µm						
Linearity *3	±0.45 µm	±0.9 µm	±2.0 µm	±0.45 µm	±0.7 µm	±0.7 µm	±1.1 µm
Spot diameter (Total measurement range) *4	9 µm dia.	13 µm dia.	18 µm dia.	13 µm dia.	18 µm dia.	15 µm dia.	20 µm dia.
Measurement cycle *5	80 µs to 1,600 µs						
Operating ambient illumination	Illumination on object surface max.30000 Lx: (incandescent light)						
Ambient temperature range	Operation: 0 to 50°C, Storage: -15 to +60°C (No freezing and condensation)						
Ambient humidity range	Operation/storage: 35 or 85%RH (No condensation)						
Degree of protection	IP40 (IEC60529)						
Vibration resistance (destructive)	10 to 150 Hz (half amplitude 0.35 mm), 80 mins in each of X/Y/Z directions						
Shock resistance (destructive)	150 m/s <sup>2</sup> , 6 direction, 3 times each (up/down, left/right, forward/backward)						
Temperature characteristic *6	0.6 µm/°C (0.2 µm/°C)	1.1 µm/°C (0.5 µm/°C)	1.8 µm/°C (1.0 µm/°C)	0.8 µm/°C (0.4 µm/°C)	0.8 µm/°C (0.4 µm/°C)	0.8 µm/°C (0.4 µm/°C)	0.8 µm/°C (0.4 µm/°C)
LED Safety	Risk Group 1 (IEC62471)						
Material	Chassis: aluminum die cast Fiber cable sheath: PVC Calibration ROM: PC			Chassis: SUS Fiber cable sheath: PVC Calibration ROM: PC Mounting Plate: Aluminum		Chassis: SUS, aluminum Fiber cable sheath: PVC Calibration ROM: PC Mounting Plate: Aluminum	
Fiber cable length	0.3 m, 2 m (flex-resistant cable)						
Fiber cable minimum bend radius	20 mm						
Insulation resistance (Calibration ROM)	Between case and all terminals: 20 MΩ (by 250 VDC)						
Dielectric strength (Calibration ROM)	Between case and all terminals: 1000 VAC, 50/60 Hz, 1 min						
Weight	Fiber cable length 0.3m Approx. 170g Fiber cable length 2m Approx. 180g			Fiber cable length 0.3m Approx. 29 g Fiber cable length 2m Approx. 39 g		Fiber cable length 0.3m Approx. 33g Fiber cable length 2m Approx. 43g	
Accessories	Calibration ROM fixing screw (M2×5mm) × 1, Fiber cable protective cap × 1, Strap × 1, Instruction Manual, Precautions			Installation plate × 1, Unit fixing screws (M2 × 10 mm) × 4, Calibration ROM fixing screw (M2 × 5 mm) × 1, Fiber cable protective cap × 1, Strap × 1, Instruction Manual, Precautions			

- \*1. Indicates the distance from the front of the sensor head. The pen-shaped right angle type has a maximum individual difference of ±0.15 mm in the distance from the front of the sensor head.
- \*2. Capacity value when OMRON standard mirror surface target is measured at the measurement center distance as the average of 16,384 times.  
The value when the Sensor Controller ZW-5000T is connected.
- \*3. Material setting for the OMRON standard mirror surface target: Error from an ideal straight line when measuring on mirror surface.
- \*4. Capacity value defined by 1/e<sup>2</sup> (13.5%) of the peak optical intensity of the measurement wavelength.
- \*5. When an extension fiber cable of 5 m or longer is connected, the setting range of the measurement cycle (exposure time) changes. For details, refer to *Setting Measurement Cycle* in the *ZW-8000/7000/5000 User's Manual (Cat. No. Z362)*.
- \*6. Actual value of the change in measurement value at the measurement center distance when fastened with an aluminum jig between the Sensor Head and the target, and with the Sensor Head and the Sensor Controller set in the same temperature environment.  
The value in parentheses is the actual value when using an SUS304 jig.  
When measuring the thickness, the value is calculated from the difference between the heights of the surface and rear surface, so there is no effect on the temperature change.

# ZW-8000/7000/5000 Series

## ● Sensor Controller

Item	Specifications			
	ZW-8000T	ZW-7000T	ZW-5000T	
Input/output type	NPN/PNP dual type			
Number of connected sensor heads	1			
Sensor head compatibility	ZW-S80□□/ ZW-SP80□□/ ZW-SPR80□□	ZW-S70□□/ ZW-SP70□□/ ZW-SPR70□□	ZW-S50□□/ ZW-SP50□□/ ZW-SPR50□□	
LED Safety	Risk Group 1 (IEC62471)			
LASER safety	Class1 (IEC/EN60825-1)	—		
Segment Display	Main display	11-segment white display, 6 digits		
	Sub-display	11-segment green display, 6 digits		
LED display	Status indicators	HIGH (orange), PASS (green), LOW (orange), STABILITY (green), ZERO (green), ENABLE (green), THRESHOLD-H (orange), THRESHOLD-L (orange), RUN (green)		
	EtherCAT indicator	ECAT RUN (green), L/A IN (Link/Activity IN) (green), L/A OUT (Link/Activity OUT) (green), ECAT ERR (red)		
External I/F	Ethernet	100BASE-TX/10BASE-T, Non-procedure (TCP/UDP), EtherNet/IP		
	EtherCAT	EtherCAT exclusive protocol 100BASE-TX		
	RS-232C	Max. 115,200 bps		
	Analog output terminal block	Analog voltage output (OUT V)	-10 V to +10 V, output impedance: 100 Ω	
		Analog current output (OUT A)	4 mA to 20 mA, max. load resistance: 300 Ω	
	32-pole expansion connector	Judgment output (HIGH/PASS/LOW)	Transistor output system Output voltage: 21.6 to 30 VDC Load current: 50 mA or less Residual voltage when turning ON: 2 V or less Leakage voltage when turning OFF: 0.1 mA or less	
		Busy output (BUSY)		
		Alarm output (ALARM)		
		Enable output (ENABLE)		
		Sync flag output (SYNFLG)		
		Trigger busy output (TRIGBUSY)		
		Logging state output (LOGSTAT)		
		Logging error output (LOGERR)		
		Stability output (STABILITY)		
		Task state output (TASKSTAT)		
		LIGHT OFF input (LIGHT OFF)		
Zero reset input (ZERO)				
Timing input (TIMING)				
Reset input (RESET)	DC input system Input voltage: 24 VDC ± 10% (21.6 to 26.4 VDC) Input current: 7 mA Type. (24 VDC) ON voltage/ON current: 19 V/3 mA or less ON voltage/ON current: 5 V/1 mA or less			
Bank	Currently selected bank output (BANK_OUT 1 to 3)	Transistor output system Output voltage: 21.6 to 30 VDC Load current: 50 mA or less Residual voltage when turning ON: 2 V or less Leakage voltage when turning OFF: 0.1 mA or less		
	Bank Selection input (BANK_SEL 1 to 3)	DC input system Input voltage: 24 VDC ± 10% (21.6 to 26.4 VDC) Input current: 7 mA Type. (24 VDC) ON voltage/ON current: 19 V/3 mA or more OFF voltage/OFF current: 5 V/1 mA or less		

# ZW-8000/7000/5000 Series

Item	Specifications			
	ZW-8000T	ZW-7000T	ZW-5000T	
Main functions	Exposure time	Automatic/Fixed		
	Measuring cycle *1	60 μs to 7,500 μs	20 μs to 400 μs	80 μs to 1,600 μs
	Material setting	Standard/Mirror/Rough surfaces		
	Measurement item	Height/Thickness of transparent object/Calculation		
	Filtering	Median/Average/Differentiation/High pass/Low pass/Band pass		
	Output	Scaling/Different holds/Zero reset/Logging for a measured value/Keep, Clamp		
	Display	Measured value/Threshold value/Analog output voltage or current value/Judgment result/Resolution/Light power/Internal logging condition/Peak amount of received light		
	Number of configurable banks	NORMAL mode: Max. 8 banks JUDGMENT mode: Max. 32 banks		
	Task process	Multi-task (up to 4 tasks per bank)		
	System	Save/Initialization/Display measured information/Communication settings/ Sensor head calibration/Key-lock/Zero reset memory/Timing input		
Rating	Power supply voltage	21.6 to 26.4 VDC (including ripple)		
	Current consumption	700 mA or less	800 mA or less	
	Insulation resistance	Across all lead wires and FG terminal: 20 MΩ (by 250 VDC)		
	Dielectric strength	Between all lead wires and FG terminal: 500 VAC, 50/60 Hz, 1 minute		
Environmental resistance	Degree of protection	IP20 (IEC60529)		
	Vibration resistance (destructive)	10 to 55 Hz (half amplitude 0.35 mm), 50 mins in each of X/Y/Z directions		
	Shock resistance (destructive)	150 m/s <sup>2</sup> , 6 direction, 3 times each (up/down, left/right, forward/backward)		
	Ambient temperature range	Operation: 0 to 40°C, Storage: -15 to +60°C (No freezing and condensation)		
	Ambient humidity range	Operation/storage: 35 to 85%RH (No condensation)		
Grounding	D-type grounding (grounding resistance of 100 Ω or less) Note: For conventional Class D grounding			
Material	Chassis: PC			
Weight	Approx. 950g (main unit only), Approx. 150 g (Parallel cable)	Approx. 900g (main unit only), Approx. 150 g (Parallel cable)		
Accessories	Parallel cable (ZW-XCP2E) × 1 10 Fiber cleaners (ZW-XCL) × 1 Instruction Manual Member registration sheet Precautions		Parallel cable (ZW-XCP2E) × 1 10 Fiber cleaners (ZW-XCL) × 1 Fiber adapter cap × 1 Strap × 1 Instruction Manual Member registration sheet Precautions	

**Note:** The Export Trade Control Order compatible Sensor Controller (ZW-8000T/7000T/5000T) is available.

When using this Controller, the minimum resolution is 0.25 μm regardless of the connected Sensor Head and setting conditions.

\*1. When an extension fiber cable of 2 m or longer (on the ZW-8000 series), 10 m or longer (on the ZW-7000 series) or 5 m or longer (on the ZW-5000 series) is connected, the setting range of the measurement cycle (exposure time) changes. For details, refer to *Setting Measurement Cycle* in the *ZW-8000/7000/5000 User's Manual* (Cat. No. Z362).

# ZW-8000/7000/5000 Series

## ●EtherCAT Communications Specifications

Item	Specification
Communications standard	IEC61158 Type12
Physical layer	100BASE-TX(IEEE802.3)
Connectors	RJ45 × 2 ECAT IN: EtherCAT input ECAT OUT: EtherCAT output
Communications media	Category 5 or higher (cable with double, aluminum tape and braided shielding) is recommended.
Communications distance	Distance between nodes: 100 m max.
Process data	Variable PDO mapping
Mailbox (CoE)	Emergency messages, SDO requests, SDO responses, and SDO information
Distributed clock	Synchronization in DC mode.
LED display	L/A IN (Link/Activity IN) × 1, AL/A OUT (Link/Activity OUT) × 1, AECAT RUN × 1, AECAT ERR × 1

## ●Automation Software Sysmac Studio

Item	Operating environment *3
Operating system (OS) *1	Windows 7 (32-bit/64-bit version)/Windows 8 (32-bit/64-bit version)/Windows 8.1 (32-bit/64-bit version)/Windows 10(32-bit/64-bit version)
CPU	Windows computers with Intel® Celeron® processor 540 (1.8 GHz) or faster CPU. Intel® Core™ i5 M520 processor (2.4 GHz) or equivalent or faster recommended.
Main memory	2 GB min. 4 GB min. recommended
Hard disk	Minimum 4.6 GB of Hard disk space is required to install. *2
Display	XGA 1024 × 768, 16,000,000 colors WXGA 1280 × 800 dots or higher resolution is recommended.
Disk drive	DVD-ROM drive
Communications ports	USB port corresponded to USB 2.0, or Ethernet port *4
Supported languages	Japanese, English, German, French, Italian, Spanish, simplified Chinese, traditional Chinese, Korean

\*1. Note about Sysmac Studio compatible operating systems: The required system and hard disk capacity differs according to the system environment.

\*2. Separate logging memory is required to use the file logging function.

\*3. Describes System Requirements and notes of Sysmac Studio Measurement Sensor Edition.

For details on System Requirements and notes of Sysmac Studio Measurement Sensor Edition, refer to Sysmac Studio Version 1 Operation Manual.

\*4. For information on how to connect a personal computer with the controller or other hardware and information on required cables, refer to manuals for each hardware.

## ●Version Information

### Sensor Head/Cable, Sensor Controller, and Sysmac Studio

The applicable version of the Sensor Controller varies depending on the Sensor Head or Cable. The versions are listed below.

Use the latest version of Sysmac Studio Standard Edition/Measurement Sensor Edition.

Sensor head/Cable		ZW Series	Version of Sensor Controller	Corresponding version of Sysmac Studio Standard Edition/Measurement Sensor Edition
Type	Model			
Square-shaped straight type	ZW-S80□□□M	ZW-8000□	Version 3.000 or later	Version 1.22 or higher
Pen-shaped straight type	ZW-SP8007 □M ZW-SP8010 □M			
Pen-shaped right-angle type	ZW-SPR8007 □M ZW-SPR8010 □M			
Extension Fiber Cable	ZW-XF80□□R			
Square-shaped straight type	ZW-S70□□□M	ZW-7000□	Version 2.030 or later	Version 1.15 or higher
Pen-shaped straight type	ZW-SP7007 □M ZW-SP7010 □M		Version 2.110 or later	
Pen-shaped right-angle type	ZW-SPR7007 □M ZW-SPR7010 □M		Version 2.030 or later	
Extension Fiber Cable	ZW-XF7002R ZW-XF7010R ZW-XF7020R ZW-XF7030R		Version 2.100 or later	
Square-shaped straight type	ZW-S50□□□M	ZW-5000□	Version 2.100 or later	Version 1.18 or higher
Pen-shaped straight type	ZW-SP5007 □M ZW-SP5010 □M		Version 2.110 or later	
Pen-shaped right-angle type	ZW-SPR5007 □M ZW-SPR5010 □M		Version 2.100 or later	
Extension Fiber Cable	ZW-XF50□□R		Version 2.100 or later	

**Note:** Refer to the *Firmware Update* in the *ZW-8000/7000/5000 User's Manual* (Cat. No. Z362) for how to update the Sensor Controller.

External Dimensions

(Unit: mm)

Sensor Head

Square-shaped straight type

ZW-S8010 □M/S8020 □M/S8030 □M

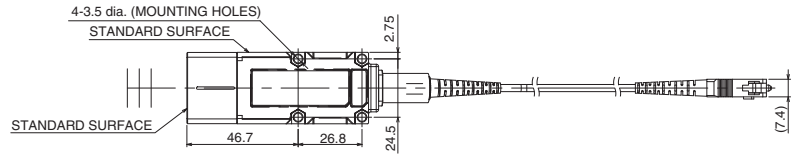
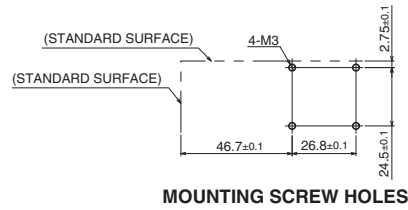

\*1.

Type	W.D.	M
ZW-S8010	10	0.5
ZW-S8020	20	1
ZW-S8030	30	2

\*2.

Length	L
0.3 m	(300)
2 m	(2000)

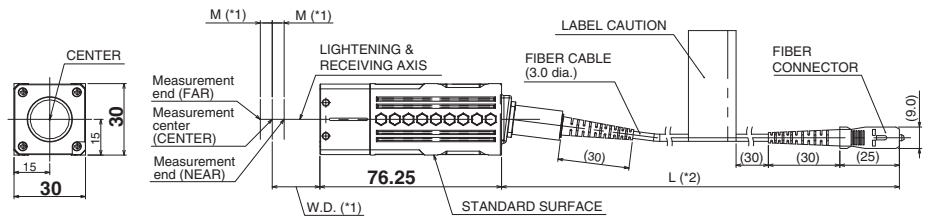

Pen-shaped straight type

ZW-SP8007 □M

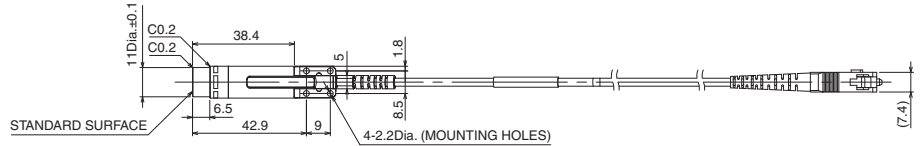
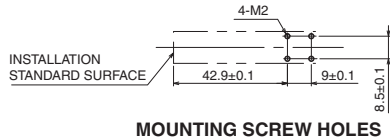

\*1.

Length	L
0.3 m	(300)
2 m	(2000)

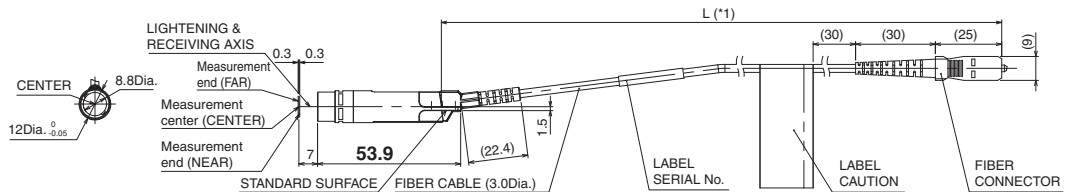

<MOUNTING PLATE>  
MATERIAL: ALUMINUM

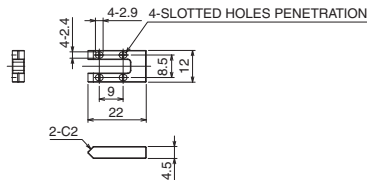

<USE SITUATION OF MOUNTING PLATE>  
SENSOR HEAD IS FASTENED WITH MOUNTING PLATE BY USING THE ACCESSORY SCREWS

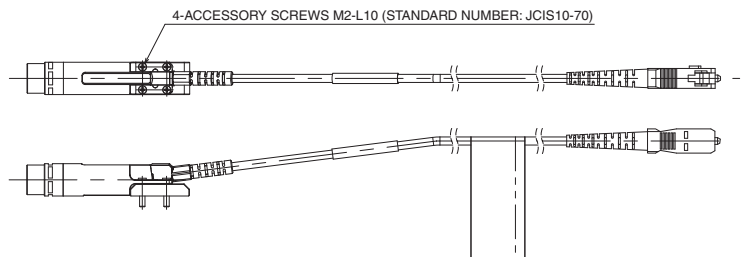

# ZW-8000/7000/5000 Series

## ZW-SP8010 □M

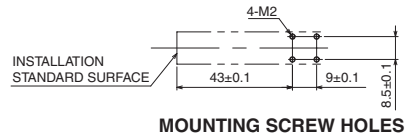

**MOUNTING SCREW HOLES**

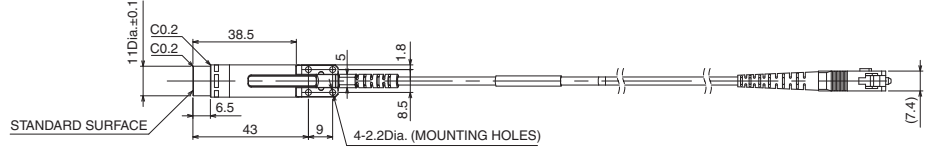

\*1.

Length	L
0.3 m	(300)
2 m	(2000)

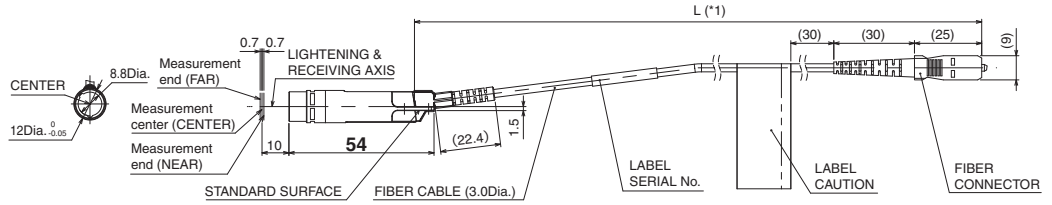

<MOUNTING PLATE>  
MATERIAL: ALUMINUM

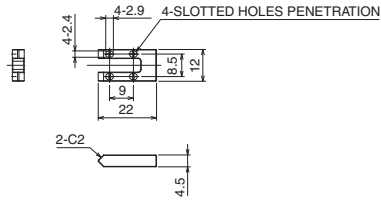

<USE SITUATION OF MOUNTING PLATE>  
SENSOR HEAD IS FASTENED WITH MOUNTING PLATE BY USING THE ACCESSORY SCREWS

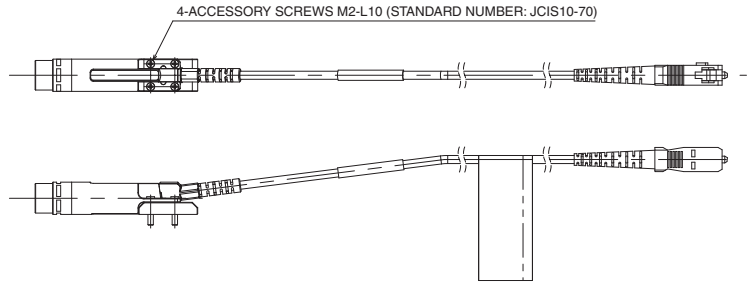



## Pen-shaped right angle type ZW-SPR8007 □M

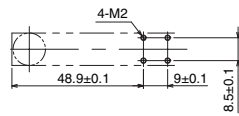

MOUNTING SCREW HOLES

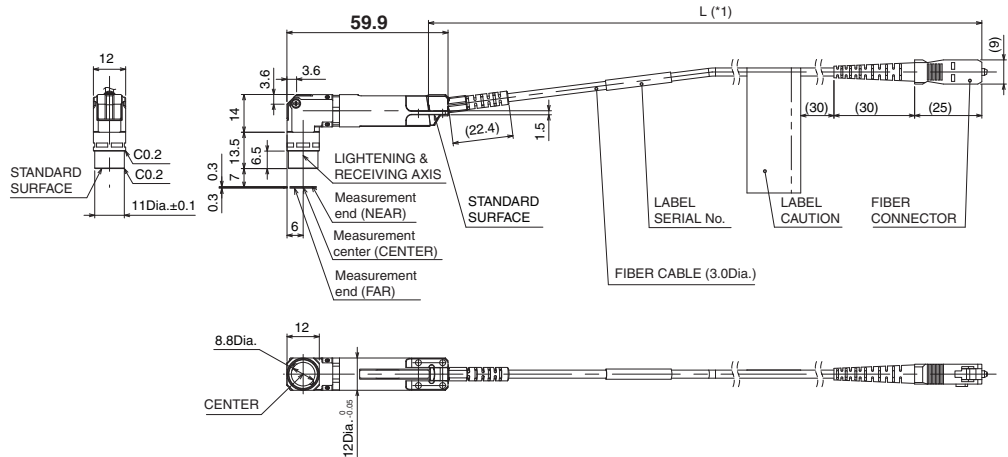
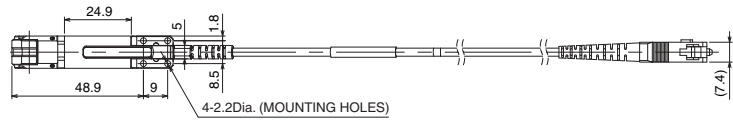

\*1.

Length	L
0.3 m	(300)
2 m	(2000)

<MOUNTING PLATE>  
MATERIAL: ALUMINUM

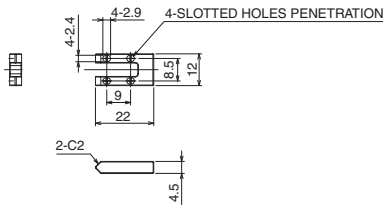

<USE SITUATION OF MOUNTING PLATE>  
SENSOR HEAD IS FASTENED WITH MOUNTING PLATE BY USING THE ACCESSORY SCREWS

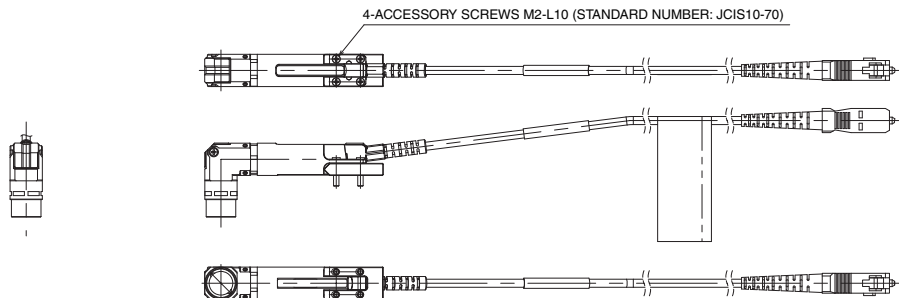

# ZW-8000/7000/5000 Series

## ZW-SPR8010 □M

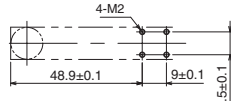

MOUNTING SCREW HOLES

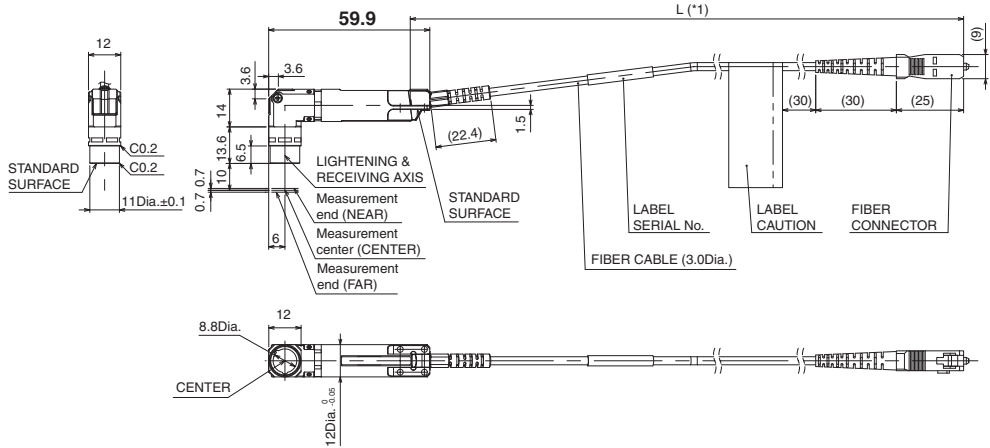
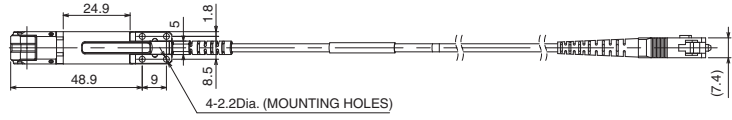

\*1.

Length	L
0.3 m	(300)
2 m	(2000)

<MOUNTING PLATE>  
MATERIAL: ALUMINUM

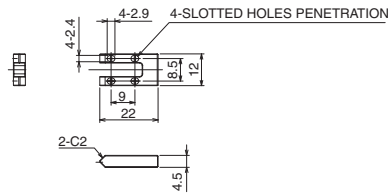

<USE SITUATION OF MOUNTING PLATE>  
SENSOR HEAD IS FASTENED WITH MOUNTING PLATE BY USING THE ACCESSORY SCREWS

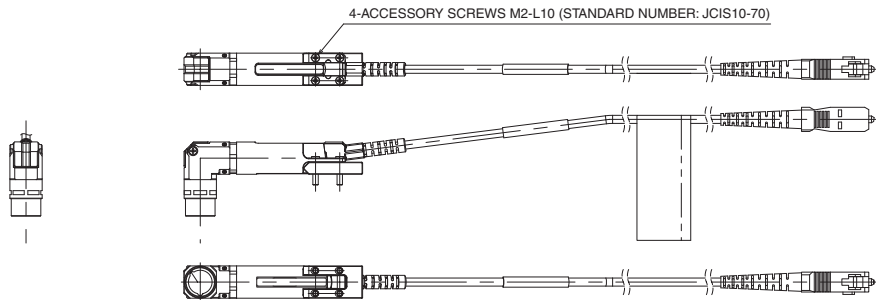

## Square-shaped straight type

ZW-S7010 □M/S7020 □M/S7030 □M/S7040 □M

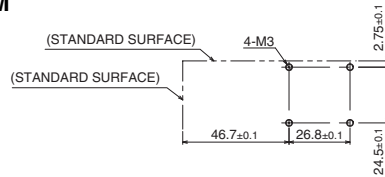

MOUNTING SCREW HOLES

\*1.

Type	W.D.	M
ZW-S7010	10	0.5
ZW-S7020	20	1
ZW-S7030	30	2
ZW-S7040	40	3

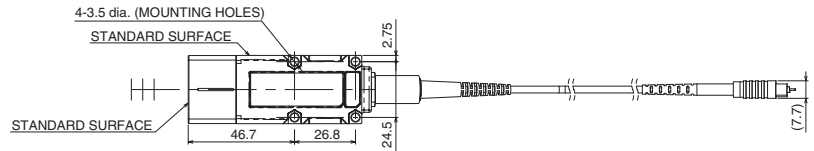

\*2.

Length	L
0.3 m	(300)
2 m	(2000)

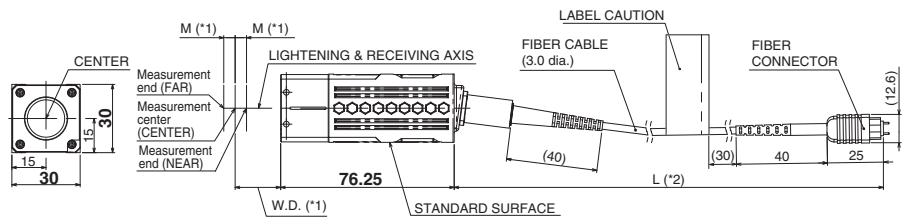

## Pen-shaped straight type

ZW-SP7007 □M

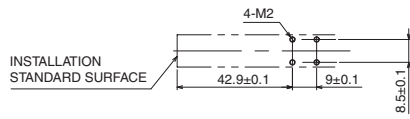

MOUNTING SCREW HOLES

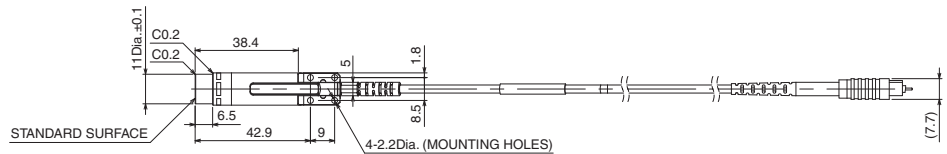

\*1.

Length	L
0.3 m	(300)
2 m	(2000)

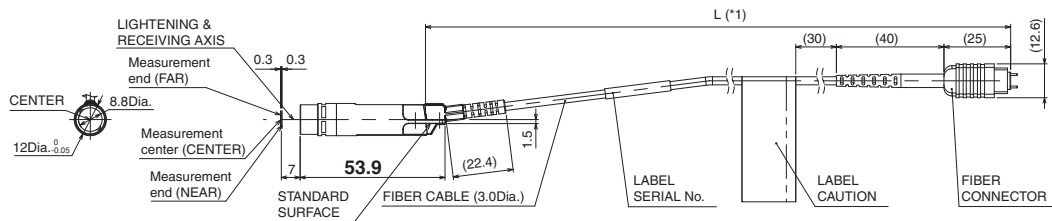

<MOUNTING PLATE>  
MATERIAL: ALUMINUM

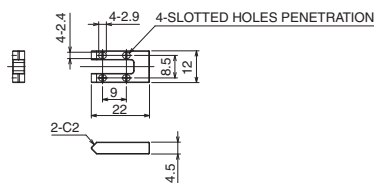

<USE SITUATION OF MOUNTING PLATE>  
SENSOR HEAD IS FASTENED WITH MOUNTING PLATE BY USING THE ACCESSORY SCREWS

4-ACCESSORY SCREWS M2-L10 (STANDARD NUMBER: JCIS10-70)

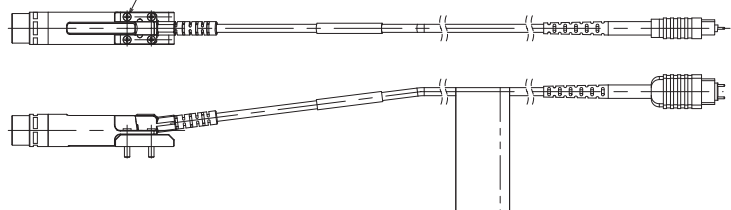

# ZW-8000/7000/5000 Series

## ZW-SP7010 □M

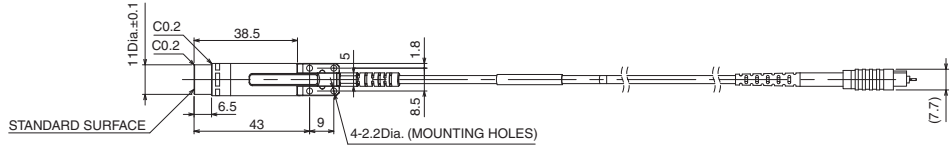
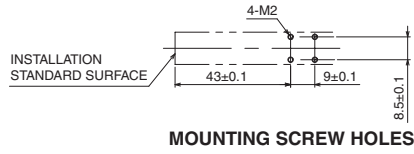

\*1.

Length	L
0.3 m	(300)
2 m	(2000)

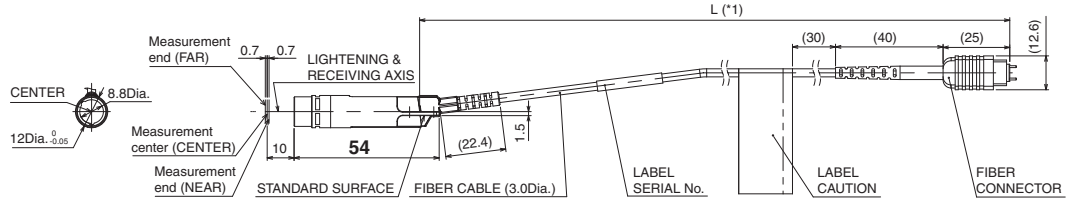

<MOUNTING PLATE>  
MATERIAL: ALUMINUM

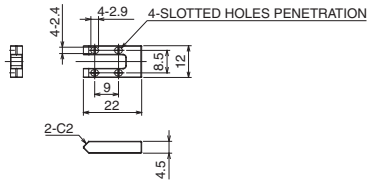

<USE SITUATION OF MOUNTING PLATE>  
SENSOR HEAD IS FASTENED WITH MOUNTING PLATE BY USING THE ACCESSORY SCREWS

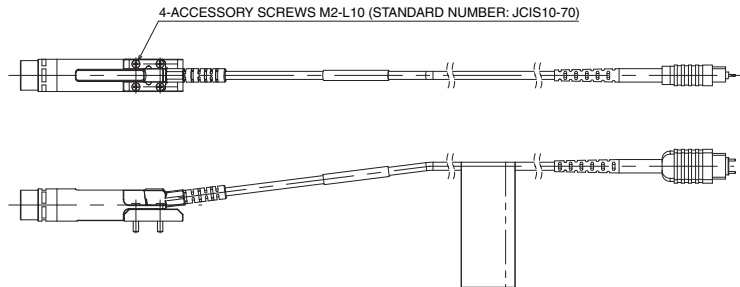

## Pen-shaped right angle type ZW-SPR7007 □M



\*1.

Length	L
0.3 m	(300)
2 m	(2000)

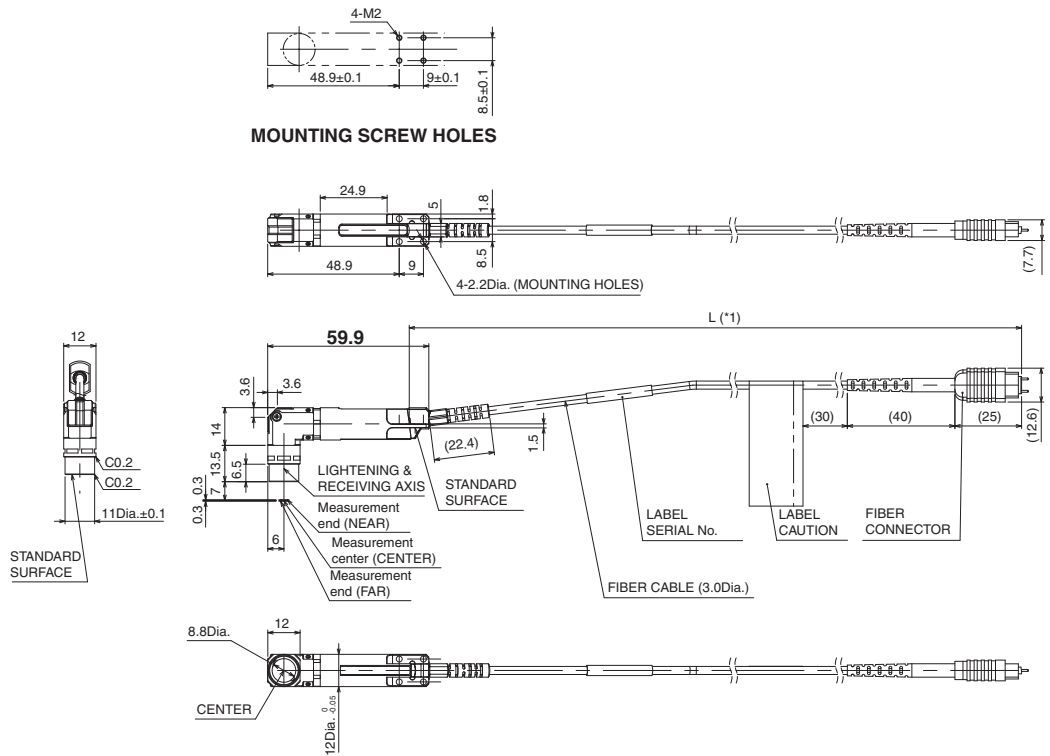

<MOUNTING PLATE>  
MATERIAL: ALUMINUM

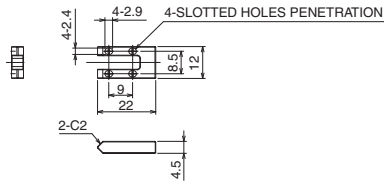

<USE SITUATION OF MOUNTING PLATE>

SENSOR HEAD IS FASTENED WITH MOUNTING PLATE BY USING THE ACCESSORY SCREWS

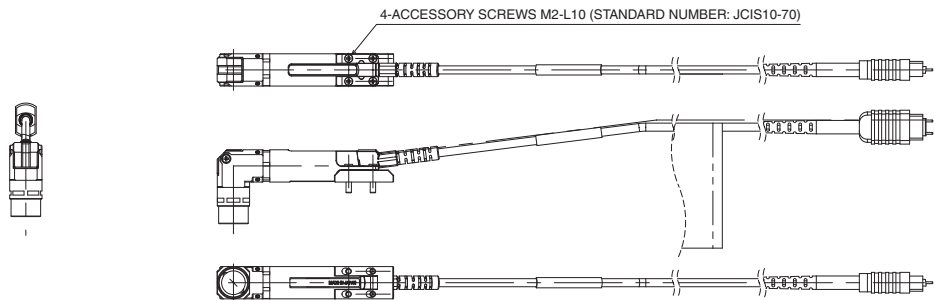

# ZW-8000/7000/5000 Series

## ZW-SPR7010 □M

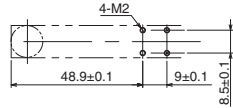

MOUNTING SCREW HOLES

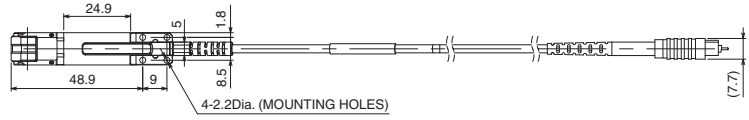

\*1.

Length	L
0.3 m	(300)
2 m	(2000)

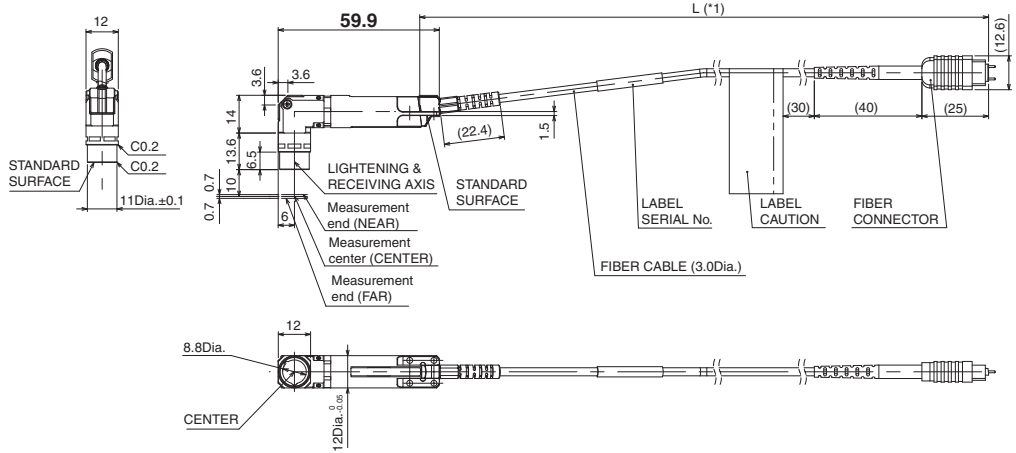

<MOUNTING PLATE>  
MATERIAL: ALUMINUM

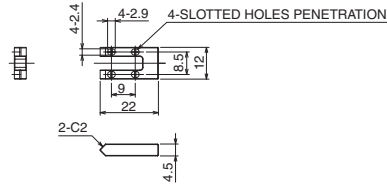

<USE SITUATION OF MOUNTING PLATE>  
SENSOR HEAD IS FASTENED WITH MOUNTING PLATE BY USING THE ACCESSORY SCREWS

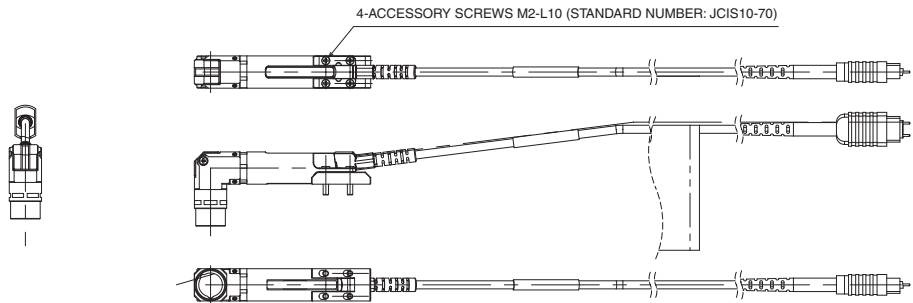

## Square-shaped straight type ZW-S5010 □M/S5020 □M/S5030 □M

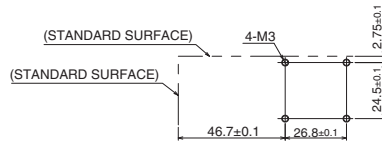

MOUNTING SCREW HOLES

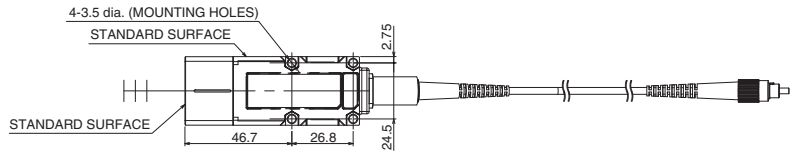

\*1.

Type	W.D.	M
ZW-S5010	10	0.5
ZW-S5020	20	1
ZW-S5030	30	2

\*2.

Length	L
0.3 m	(300)
2 m	(2000)

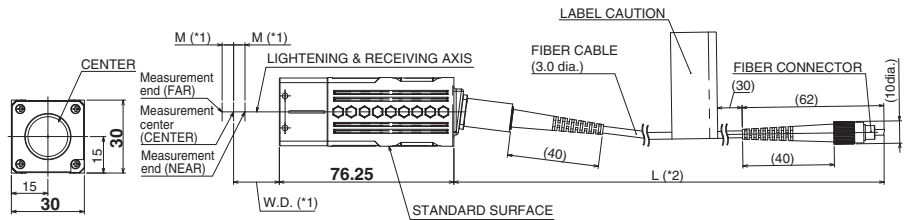

## Pen-shaped straight type ZW-SP5007 □M

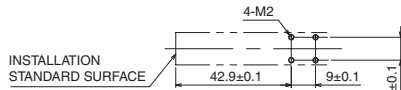

MOUNTING SCREW HOLES

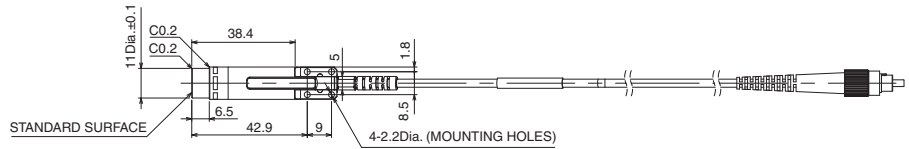

\*1.

Length	L
0.3 m	(300)
2 m	(2000)

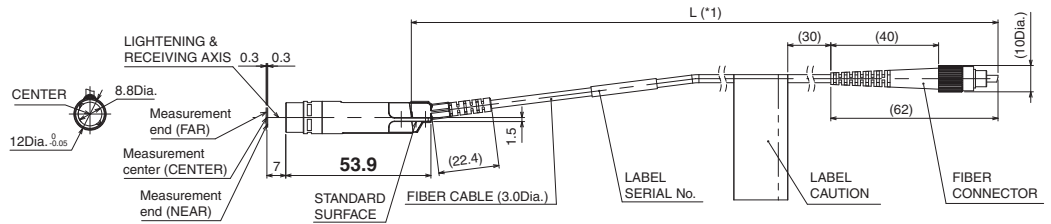

<MOUNTING PLATE>  
MATERIAL: ALUMINUM

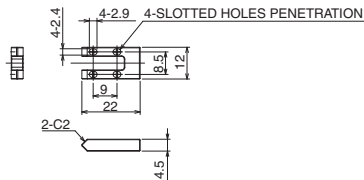

<USE SITUATION OF MOUNTING PLATE>

SENSOR HEAD IS FASTENED WITH MOUNTING PLATE BY USING THE ACCESSORY SCREWS

4-ACCESSORY SCREWS M2-L10 (STANDARD NUMBER: JCS10-70)

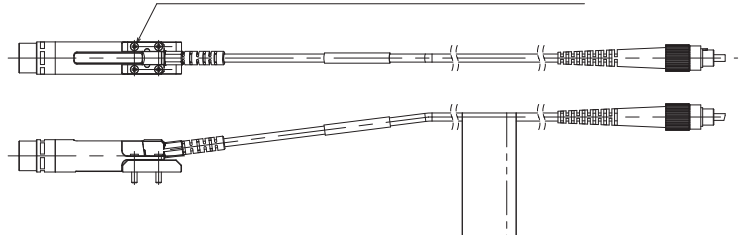

# ZW-8000/7000/5000 Series

## ZW-SP5010 □M

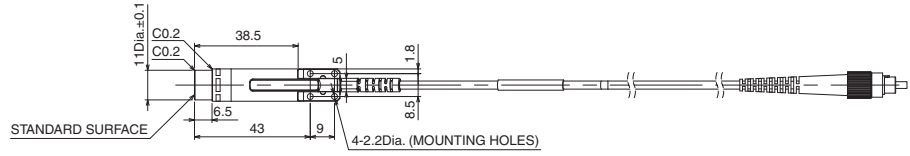
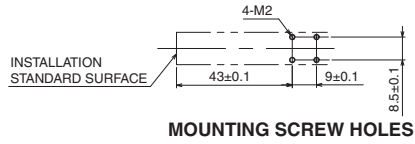

\*1.

Length	L
0.3 m	(300)
2 m	(2000)

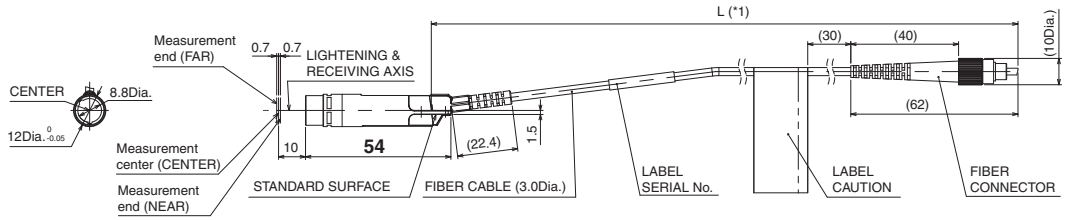

<MOUNTING PLATE>  
MATERIAL: ALUMINUM

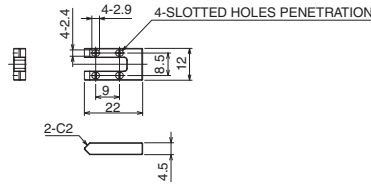

<USE SITUATION OF MOUNTING PLATE>  
SENSOR HEAD IS FASTENED WITH MOUNTING PLATE BY USING THE ACCESSORY SCREWS

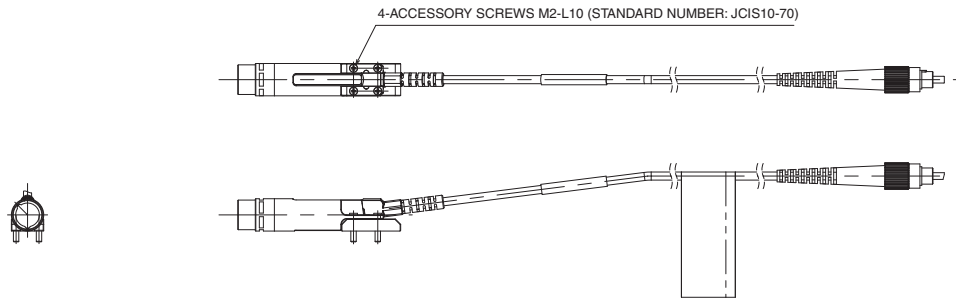



## Pen-shaped right angle type ZW-SPR5007 □M



\*1.

Length	L
0.3 m	(300)
2 m	(2000)

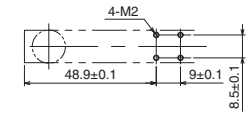

MOUNTING SCREW HOLES

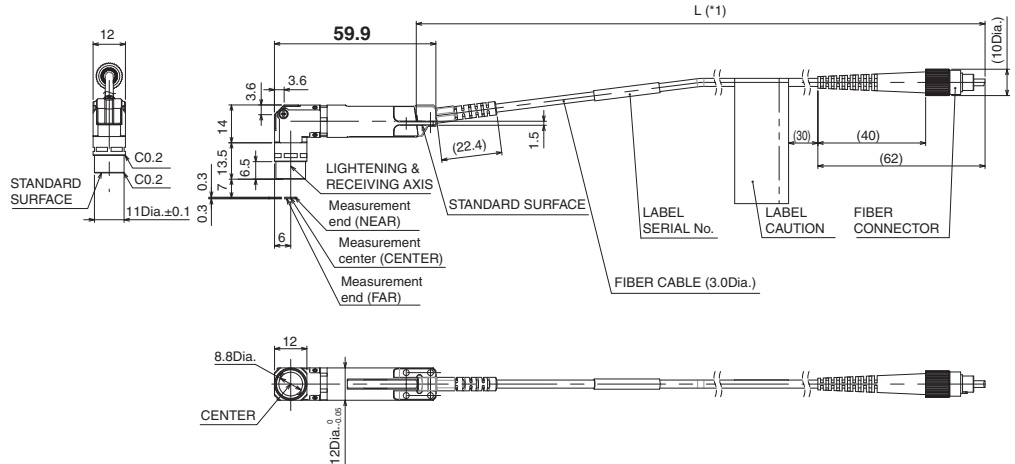
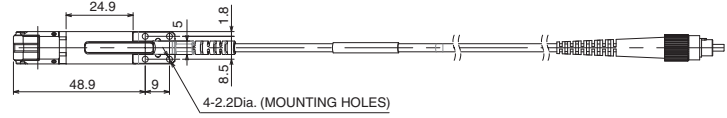

<MOUNTING PLATE>  
MATERIAL: ALUMINUM

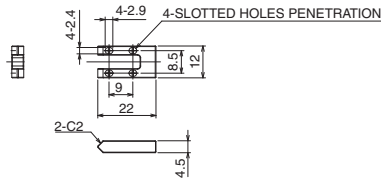

<USE SITUATION OF MOUNTING PLATE>  
SENSOR HEAD IS FASTENED WITH MOUNTING PLATE BY USING THE ACCESSORY SCREWS

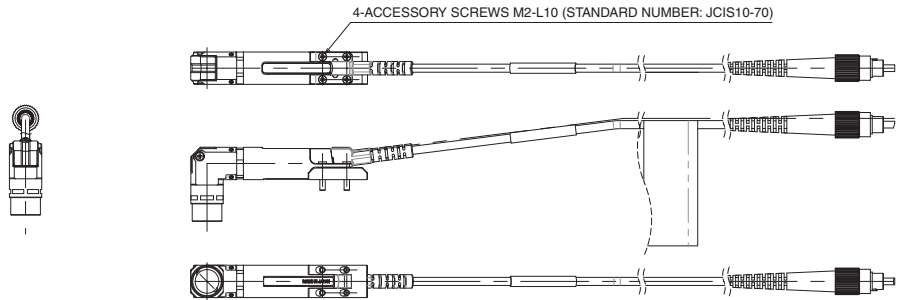

# ZW-8000/7000/5000 Series

## ZW-SPR5010 □M



\*1.

Length	L
0.3 m	(300)
2 m	(2000)

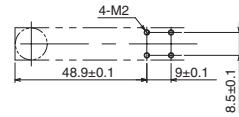

MOUNTING SCREW HOLES

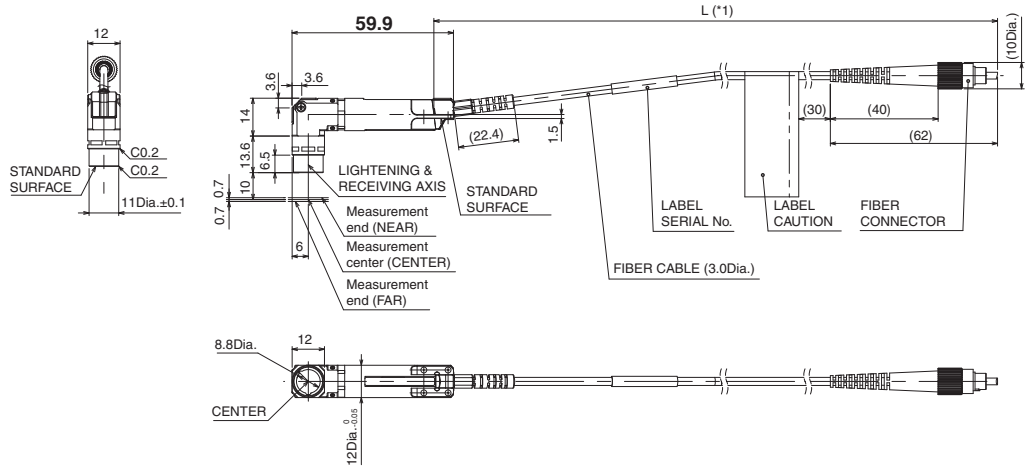
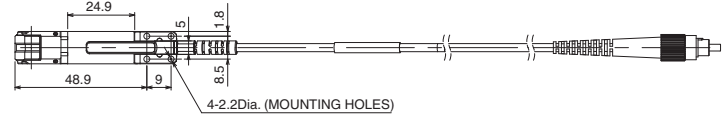

<MOUNTING PLATE>  
MATERIAL: ALUMINUM

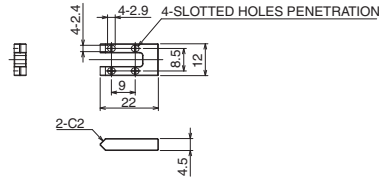

<USE SITUATION OF MOUNTING PLATE>  
SENSOR HEAD IS FASTENED WITH MOUNTING PLATE BY USING THE ACCESSORY SCREWS

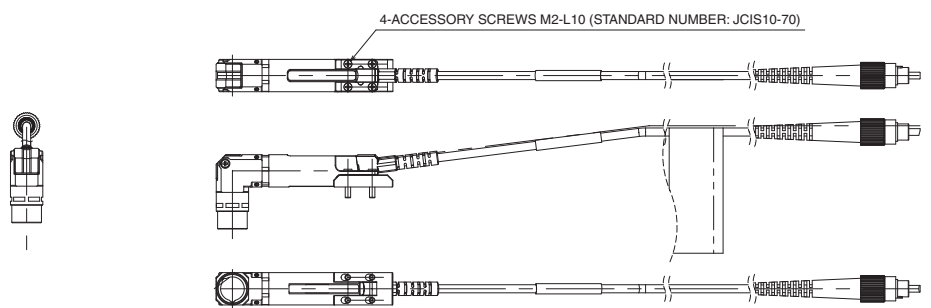

Sensor Controller

ZW-8000T

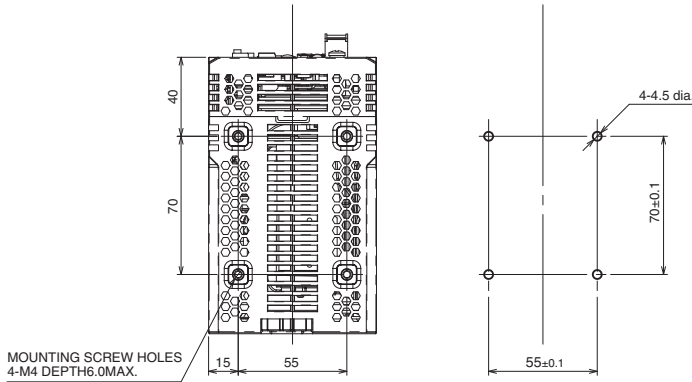
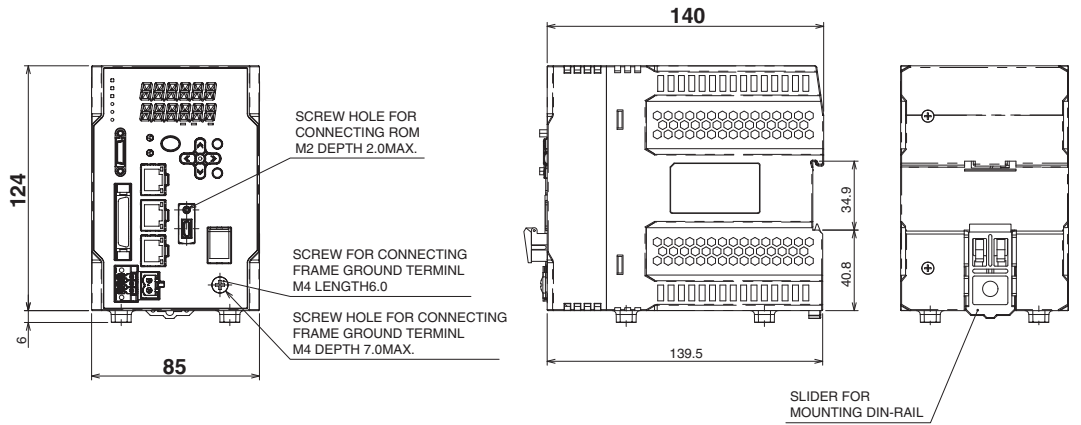

MOUNTING SCREW HOLES

ZW-7000T

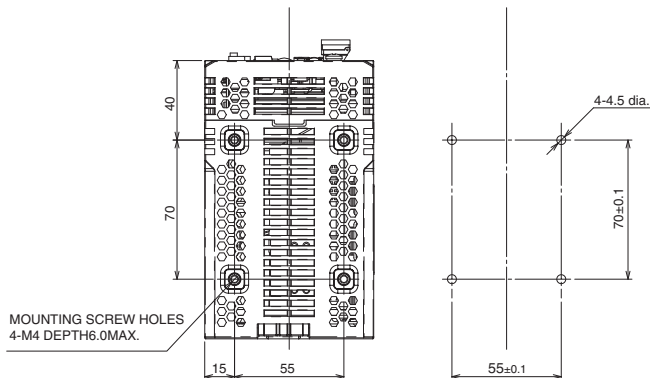
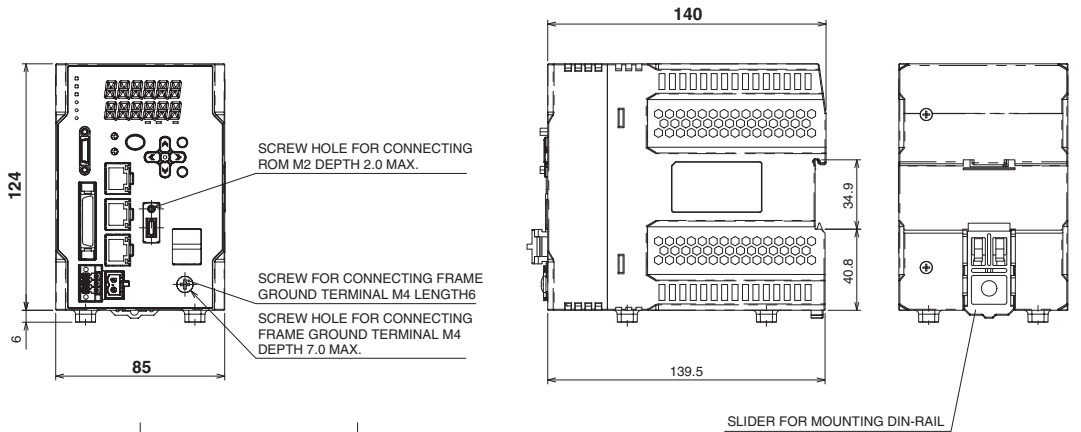

MOUNTING SCREW HOLES

# ZW-8000/7000/5000 Series

## ZW-5000T

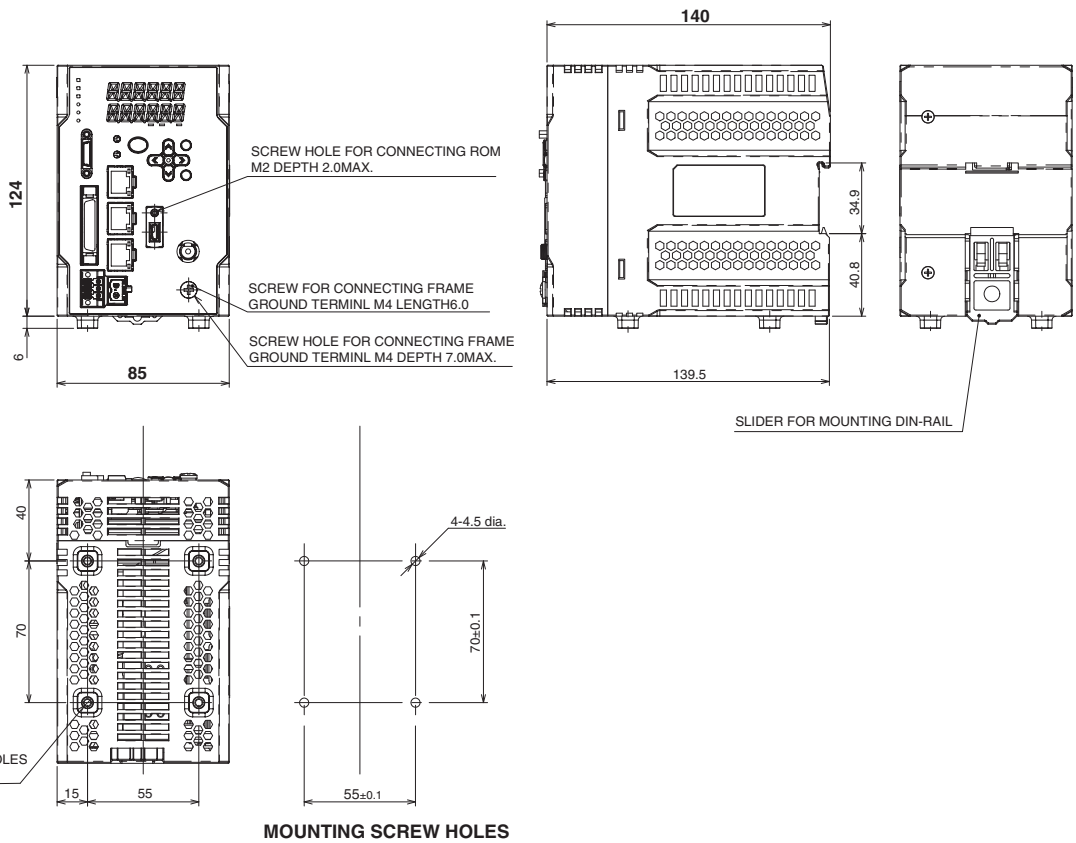

## Extension Fiber Cable

### ZW-XF8002R/XF8005R/XF8010R/XF8020R/XF8030R

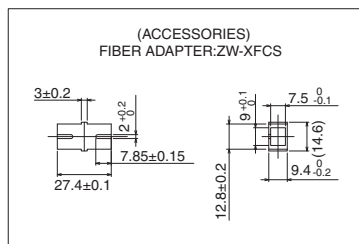
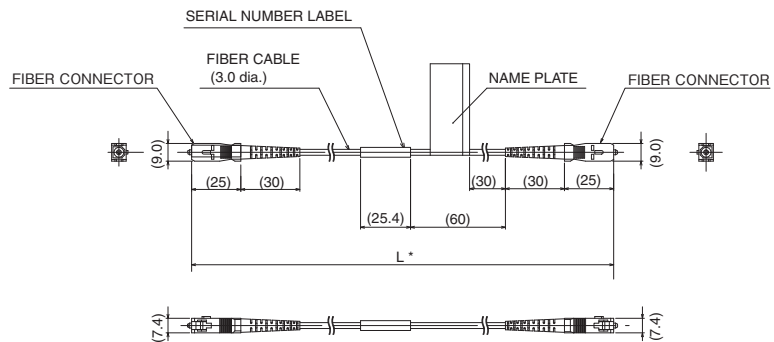

\* The following table lists cable lengths per models.

Type	Specification	L
ZW-XF8002R	2 m	2000+40/0
ZW-XF8005R	5 m	5000+100/0
ZW-XF8010R	10 m	10000+200/0
ZW-XF8020R	20 m	20000+400/0
ZW-XF8030R	30 m	30000+600/0

## ZW-XF7002R/XF7005R/XF7010R/XF7020R/XF7030R

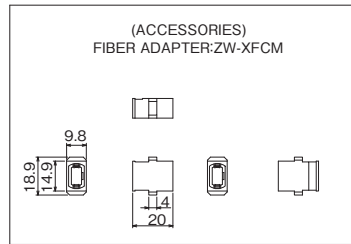
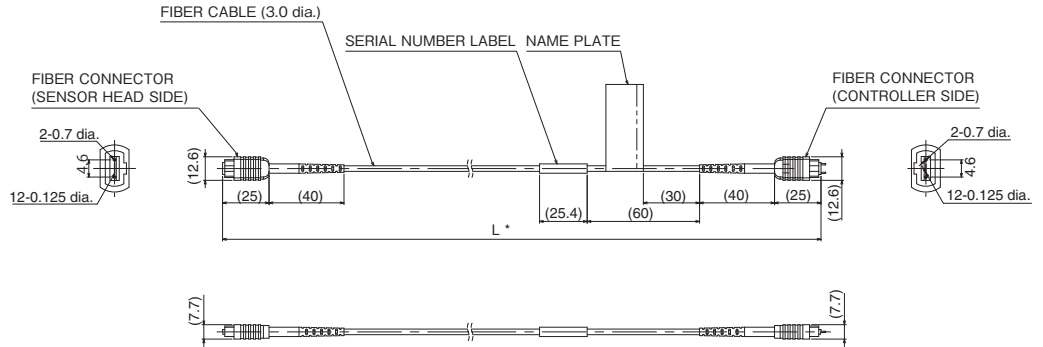

\* The following table lists cable lengths per models.

Type	Specification	L
ZW-XF7002R	2 m	2000+40/0
ZW-XF7005R	5 m	5000+100/0
ZW-XF7010R	10 m	10000+200/0
ZW-XF7020R	20 m	20000+400/0
ZW-XF7030R	30 m	30000+600/0

## ZW-XF5002R/XF5005R/XF5010R/XF5020R/XF5030R

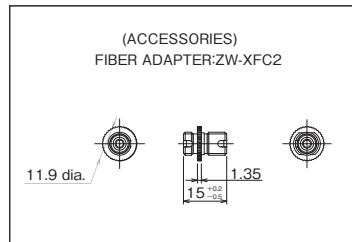
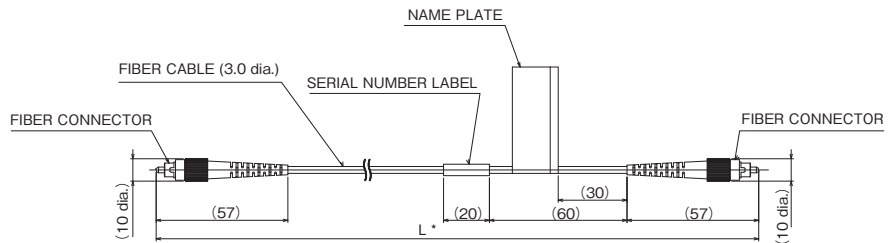

\* The following table lists cable lengths per models.

Type	Specification	L
ZW-XF5002R	2 m	2000+200/0
ZW-XF5005R	5 m	5000+200/0
ZW-XF5010R	10 m	10000+200/0
ZW-XF5020R	20 m	20000+500/0
ZW-XF5030R	30 m	30000+500/0

## Related Manuals

Man.No.	Model number	Manual
Z362	ZW-8000□/7000□/5000□	Displacement Sensor ZW-8000/7000/5000 User's Manual
Z363	ZW-8000□/7000□/5000□	Displacement Sensor ZW-8000/7000/5000 User's Manual for Communications Settings
W504	SYSMAC-SE2	Sysmac Studio Version 1 Operation Manual

- EtherCAT® is a registered trademark and patented technology, licensed by Beckhoff Automation GmbH, Germany.
- EtherNet/IP™ is a trademark of ODVA.
- Sysmac is a trademark or registered trademark of OMRON Corporation in Japan and other countries for OMRON factory automation products.
- Windows is a registered trademark of Microsoft Corporation in the USA and other countries.
- Other company names and product names in this document are the trademarks or registered trademarks of their respective companies.
- The product photographs and figures that are used in this catalog may vary somewhat from the actual products.
- Microsoft product screen shot(s) are reprinted with permission from Microsoft Corporation.

Note: Do not use this document to operate the Unit.

**OMRON Corporation Industrial Automation Company**  
Kyoto, JAPAN

Contact: [www.ia.omron.com](http://www.ia.omron.com)

**Regional Headquarters**

**OMRON EUROPE B.V.**

Wegalaan 67-69, 2132 JD Hoofddorp  
The Netherlands  
Tel: (31)2356-81-300/Fax: (31)2356-81-388

**OMRON ELECTRONICS LLC**

2895 Greenspoint Parkway, Suite 200  
Hoffman Estates, IL 60169 U.S.A.  
Tel: (1) 847-843-7900/Fax: (1) 847-843-7787

**OMRON ASIA PACIFIC PTE. LTD.**

No. 438A Alexandra Road # 05-05/08 (Lobby 2),  
Alexandra Technopark,  
Singapore 119967  
Tel: (65) 6835-3011/Fax: (65) 6835-2711

**OMRON (CHINA) CO., LTD.**

Room 2211, Bank of China Tower,  
200 Yin Cheng Zhong Road,  
PuDong New Area, Shanghai, 200120, China  
Tel: (86) 21-5037-2222/Fax: (86) 21-5037-2200

**Authorized Distributor:**

© OMRON Corporation 2016-2018 All Rights Reserved.  
In the interest of product improvement,  
specifications are subject to change without notice.  
CSM\_6\_2\_1019

**Cat. No. Q250-E1-04**

1218 (0316)