

CHORUSMART

GEWISS



TERMOSTATO ELETTRONICO ESTATE/INVERNO
ELECTRONIC SUMMER/WINTER THERMOSTAT
THERMOSTAT ÉLECTRONIQUE ETE/HIVER
TERMOSTATO ELECTRÓNICO VERANO/INVIERNO
ELEKTRONISCHER THERMOSTAT SOMMER/WINTER



TERMOSTAT ELECTRONIC VARĂ/IARNĂ



GW10705
GW12705
GW13705

GW11705
GW14705
GW15705

► **Attenzione - Importante**

Attenzione ! La sicurezza dell'apparecchio è garantita solo attenendosi alle istruzioni qui riportate. Pertanto è necessario leggerle e conservarle.

I prodotti Chorus devono essere installati conformemente a quanto previsto dalla norma CEI 64-8 per gli apparecchi per uso domestico e similare, in ambienti non polverosi e dove non sia necessaria una protezione speciale contro la penetrazione di acqua.

L'organizzazione di vendita GEWISS é a disposizione per chiarimenti e informazioni tecniche.

GENERALITÀ PRODOTTO	<i>pag.</i>
- Funzioni.....	4
ISTRUZIONI D'INSTALLAZIONE	
- Logica applicativa.....	5
- Collegamenti elettrici.....	7
ISTRUZIONI D'IMPIEGO	
- Comandi e segnalazioni.....	8

GENERALITÀ PRODOTTO

Funzioni

DATI PRESTAZIONALI

Funzione estate / inverno.

Segnalazioni luminose:

- Led giallo funzione di localizzazione.
- Led verde indicazione stato uscita (accesso contatto NA chiuso).

DATI TECNICI

Tensione di alimentazione:	230 V~ 50÷60 Hz
Potenza assorbita:	2VA
Tipo di uscita:	a relé con contatto in scambio NA/COM/NC 8 A / 250 V~
Collegamenti utenza (carico):	2 o 3 conduttori
Sezione massima dei fili ai morsetti:	2,5 mm ²
Tipo di isolamento:	Classe II 
Grado di protezione:	IP 30
Polluzione:	Normale
Campo di regolazione:	da +5°C a +35°C
Differenziale termico:	1°C
Limiti della temperatura di funzionamento:	0°C ÷ +50°C
Normative di riferimento per marcatura CE:	
EMC EN55014-1 EN55014-2 EN61000-3-2 EN61000-3-3	
LVD EN60730-1 EN60730-2-9	
(Direttive 2006/95/CE - 2004/108/CE)	

ISTRUZIONI D'INSTALLAZIONE



Logica applicativa

I
T
A
L
I
A
N
O

OK

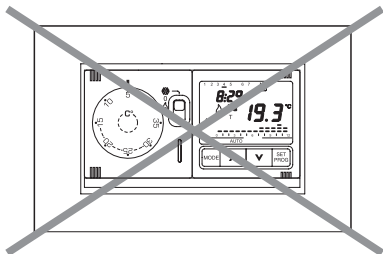
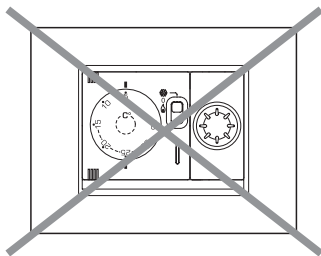
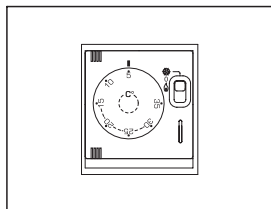

ISTRUZIONI D'INSTALLAZIONE

Logica applicativa

Consigli sul posizionamento:

Installare il termostato a quota 1,50÷1,70 m dal pavimento, lontano da sorgenti di calore, prese d'aria, porte o finestre. Non installare su pareti perimetrali.

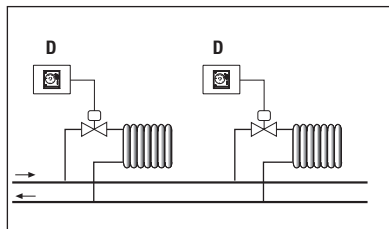
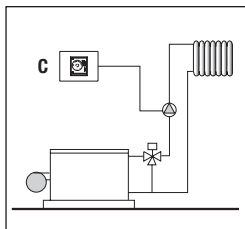
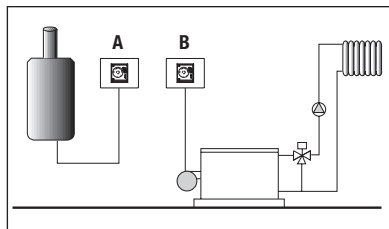
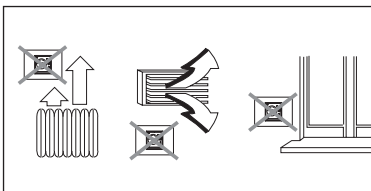
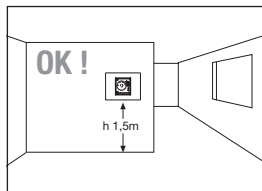

Impianti di riscaldamento
con termostato che comanda:

- A Caldaia murale
- B Bruciatore
- C Pompa di circolazione
- D Elettrovalvola di zona

N.B.: Gli esempi riportati nella seguente documentazione sono di principio

ISTRUZIONI D'INSTALLAZIONE

Collegamenti elettrici

Importante: l'installazione ed il collegamento elettrico dei dispositivi ed apparecchiature devono essere eseguiti da personale qualificato ed in conformità alle norme e leggi vigenti. Il costruttore non si assume nessuna responsabilità per quanto concerne l'impiego di prodotti che debbano seguire particolari norme di ambienti e/o installazione, il cui onere resta di competenza ed a carico dell'installatore.

Attenzione: prima di effettuare l'installazione del prodotto, disattivare la tensione di rete.

Con disattivata la tensione di rete:

Collegare i fili di alimentazione ai morsetti n° L (Linea) e n° N (Neutro).

Collegare i fili del dispositivo da comandare ai morsetti: n° 1 = contatto NA

n° 2 = comune

n° 3 = contatto NC

Con forti carichi induttivi (pompe ed elettrovalvole) si consiglia di collegare un filtro RC in parallelo al carico.

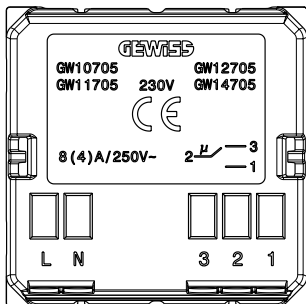

Morsetti di cablaggio

Alimentazione: L - Fase
N - Neutro

Relè di uscita: 1 - Contatto NA
2 - Comune
3 - Contatto NC

ISTRUZIONI D'IMPIEGO

Comandi e segnalazioni

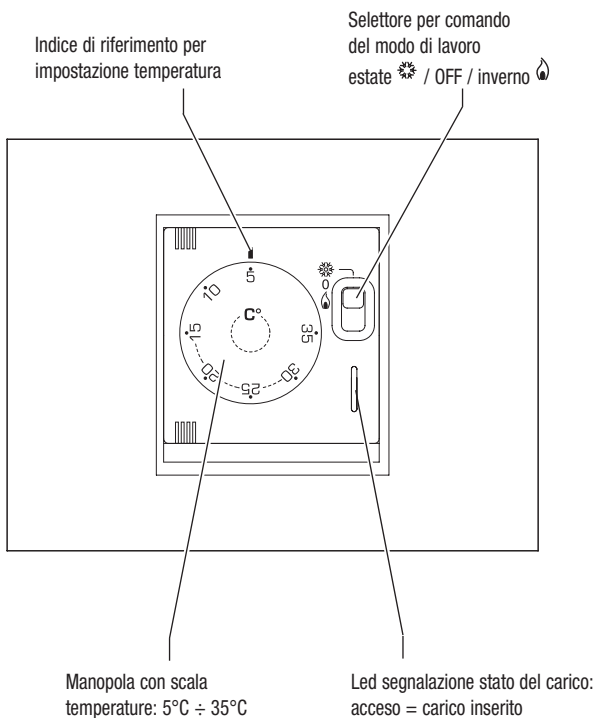

E N G L I S H

Electronic summer/winter thermostat

▶ Attention - Important

Warning ! The safety of this appliance is only guaranteed if all the instructions given here are followed scrupulously.

These should be read thoroughly and kept in a safe place.

Chorus products can be installed in environments which are dust-free and where no special protection against the penetration of water is required. They shall be installed in compliance with the requirements for household devices set out by the national standards and rules applicable to low-voltage electrical installations which are in force in the country where the products are installed, or, when there are none, following the international standard for low-voltage electrical installations IEC 60364, or the European harmonization document HD 60364. Gewiss sales organization is ready to provide full explanations and technical data on request.

INDEX

GENERAL PRODUCT DESCRIPTION	<i>page</i>
- Functions	12
INSTALLATION INSTRUCTIONS	
- Location advice	13
- Electrical connections.....	15
OPERATING INSTRUCTIONS	
- Commands and signals	16

GENERAL PRODUCT DESCRIPTION

Functions

PERFORMANCE DATA

Function summer / winter.

Luminous signals:

- Yellow localisation function LED.
- Green output status indicator LED (NA contact access closed).

TECHNICAL SPECIFICATIONS

Power supply:	230 V~ 50÷60 Hz
Power absorbed:	2VA
Type of relay output:	with exchange contact NA/COM/NC 8 A / 250 V~
User connections (load):	2 or 3 wires
Max. wire section at the terminals:	2,5 mm ²
Type of insulation:	Class II 
Grade of protection:	IP 30
Pollution:	Normal
Regulation range:	from +5°C to +35°C
Hysteresis:	1°C
Temperature operating limits:	0°C ÷ +50°C
Reference standards for CE marking:	
EMC EN55014-1 EN55014-2 EN61000-3-2 EN61000-3-3	
LVD EN60730-1 EN60730-2-9	
(Directive 2006/95/EC - 2004/108/EC)	

INSTALLATION INSTRUCTIONS



Location advice

OK

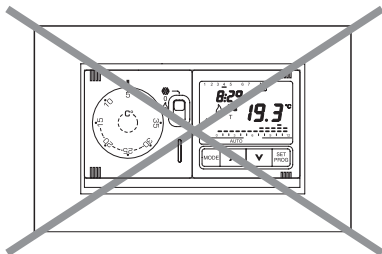
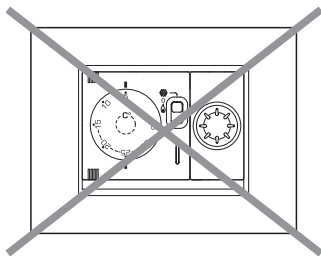
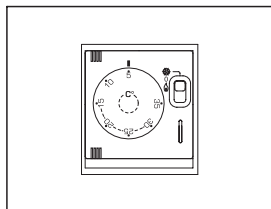

INSTALLATION INSTRUCTIONS

Location advice

Recommendations for positioning:

Install the thermostat at a height of approx. 1.50÷1.70 m from floor level, away from heat sources, draughts, doors and windows. Do not install on perimeter walls.

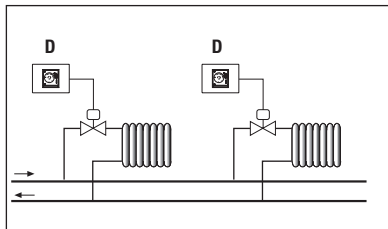
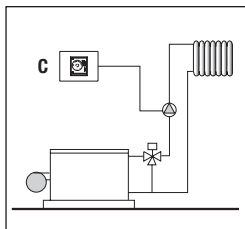
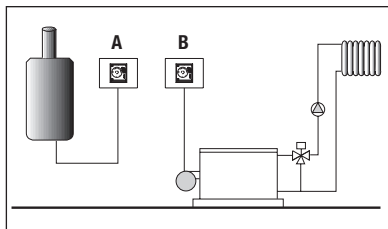
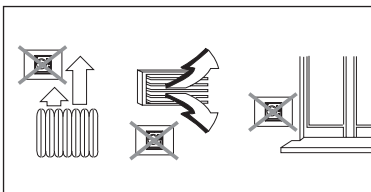
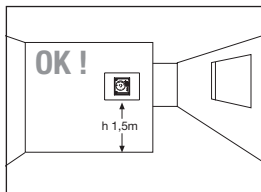

Heating systems with thermostat controlling:
A Wall mounted boiler
B Burner
C Circulation pump
D Zone solenoid valve

N.B.: The examples given in the following documentation are for illustrative purposes only.

INSTALLATION INSTRUCTIONS

Electrical connections

Important: the installation and electrical connecting of the devices and appliances must be undertaken by qualified personnel and in accordance with standards and regulations in force at the time. The manufacture declines to accept any responsibility concerning the use of the products in accordance with particular environmental or installation regulations, as this responsibility rests entirely with the installer.

Warning: Prior to installing the product, ensure the mains electrical supply is disconnected.

With the mains power supply disconnected:

Connect the power supply wires to terminals:

n° L (Line) and n° N (Neutral).

Connect the wires of the device to be controlled to terminals:

n° 1 = NA contact

n° 2 = common

n° 3 = NC contact

With strong inductive loads (pumps and solenoid valves) it is recommended that an RC filter is connected in parallel to the load.

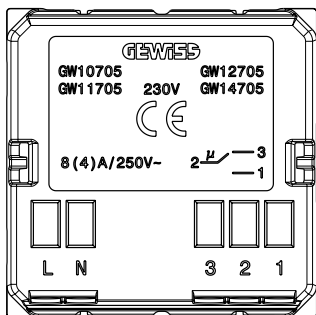

Cabling terminals

Power supply : L - Phase
N - Neutral

Output relay: 1 = NA contact
2 = common
3 = NC contact

OPERATING INSTRUCTIONS

Commands and signal

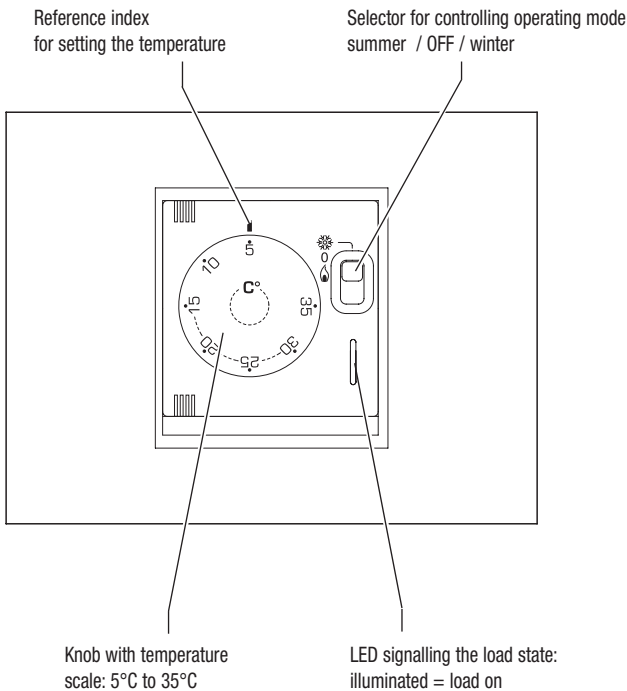

F R A N C A I S

Thermostat électrique été/hiver

► Attention - Important

Attention ! La sécurité de cet appareil n'est garantie que si toutes les instructions données ici sont suivies scrupuleusement.

Il convient de les lire attentivement et de les conserver en lieu sûr.

Les produits de la série Chorus peuvent être installés dans un environnement exempt de poussière et où aucune protection spéciale contre la pénétration d'eau n'est nécessaire. Ils doivent être installés en conformité avec les exigences relatives aux appareils à usages domestiques et analogues prévues par les normes et règles nationales applicables aux installations électriques à basse tension en vigueur dans le pays où les produits sont installés, ou, en leur absence, en respectant la norme internationale relative aux installations électriques à basse tension CEI 60364, ou le document d'harmonisation européen HD 60364.

Le réseau de vente de Gewiss est prêt à fournir des explications complètes et des données techniques sur demande.

SOMMAIRE

GENERALITES SUR LE PRODUIT	<i>page</i>
- Fonctions.....	20
 INSTRUCTIONS POUR L'INSTALLATION	
- Logique d'application	21
- Raccordements électriques	23
 INSTRUCTIONS POUR L'EMPLOI	
- Commandes et signalisations	24

GENERALITES SUR LE PRODUIT

Fonctions

DONNEES SUR LES PERFORMANCES DE L'APPAREIL

Fonction été / hiver.

Voyants lumineux :

- Led jaune fonction de localisation.
- Led verte indication état de sortie (accès contact NO fermé).

DONNEES TECHNIQUES

Tension d'alimentation :	230 V~ 50÷60 Hz
Puissance absorbée :	2VA
Type de sortie :	à relais avec contact en échange NO/COMM/NF 8 A / 250 V~
Raccordement appareil (charge) :	2 ou 3 conducteurs
Section maximum des fils aux borniers :	2,5 mm ²
Type d'isolement :	Classe II 
Degré de protection :	IP 30
Pollution :	Normale
Plage de réglages :	de +5°C au +35°C
Hystérésis :	1°C
Limites de la température de fonctionnement :	0°C ÷ +50°C
Réglémentations de référence pour marque CE :	
EMC EN55014-1 EN55014-2 EN61000-3-2 EN61000-3-3	
LVD EN60730-1 EN60730-2-9	
(Directives 2006/95/CE - 2004/108/CE)	

INSTRUCTIONS POUR L'INSTALLATION



Logique d'application

OK

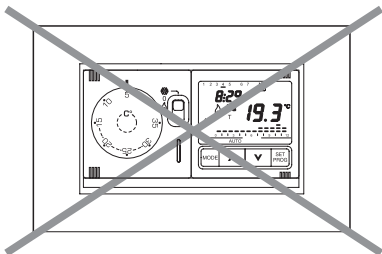
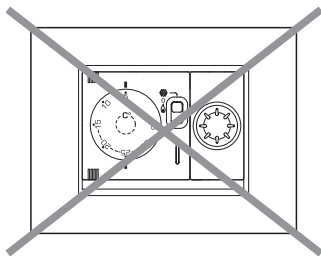
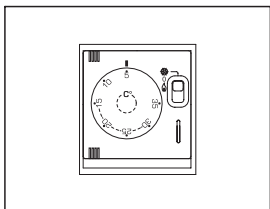

F
R
A
N
Ç
A
I
S

INSTRUCTIONS POUR L'INSTALLATION

Logique d'application

Conseils pour le positionnement :

Installer le thermostat à une hauteur de $1,50 \div 1,70$ m du sol, loin des sources de chaleur, des prises d'air, des portes ou des fenêtres. Ne pas installer sur murs périphériques.

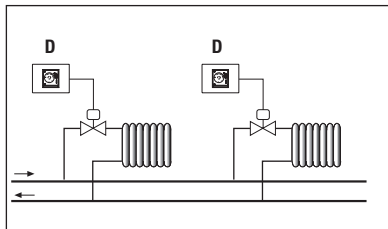
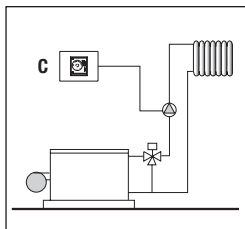
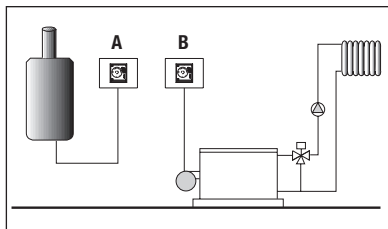
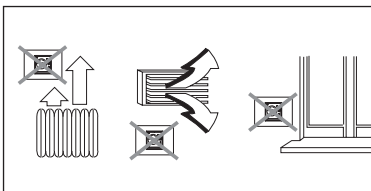
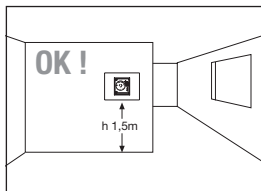

Installations de chauffage avec thermostat commandant :

- A Chaudière murale
- B Brûleur
- C Pompe de circulation
- D Electrovanne de zone

N.B.: Les exemples donnés dans la documentation suivante sont des exemples de principe.

INSTRUCTIONS POUR L'INSTALLATION

Raccordements électriques

Important : l'installation et le raccordement électrique des dispositifs et des appareils doivent être effectués par des personnes qualifiées et conformément aux normes et aux lois en vigueur. Le constructeur ne répondra aucunement en cas d'utilisation de produits ne respectant pas certaines normes du milieu ambiant et/ou d'installation, qui relèvent des compétences de l'installateur et sont entièrement à sa charge .

Attention : avant de procéder à l'installation de l'appareil, mettre hors tension.

Quand on a coupé le courant :

Connecter les fils d'alimentation aux bornes

n° L (Ligne) et n° N (Neutre).

Connecter les fils du dispositif à commander aux bornes: n° 1 = contact NO

n° 2 = commun

n° 3 = contact NF

En cas de fortes charges inductives (pompes et électrovannes) on conseille de relier un filtre RC en parallèle à la charge .

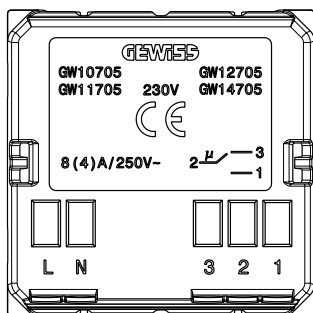

Bornes de câblage

Alimentation : L - Phase
N - Neutre

Relais de sortie: 1 = contact NO
2 = commun
3 = contact NF

INSTRUCTIONS POUR L'EMPLOI

Commandes et signalisations

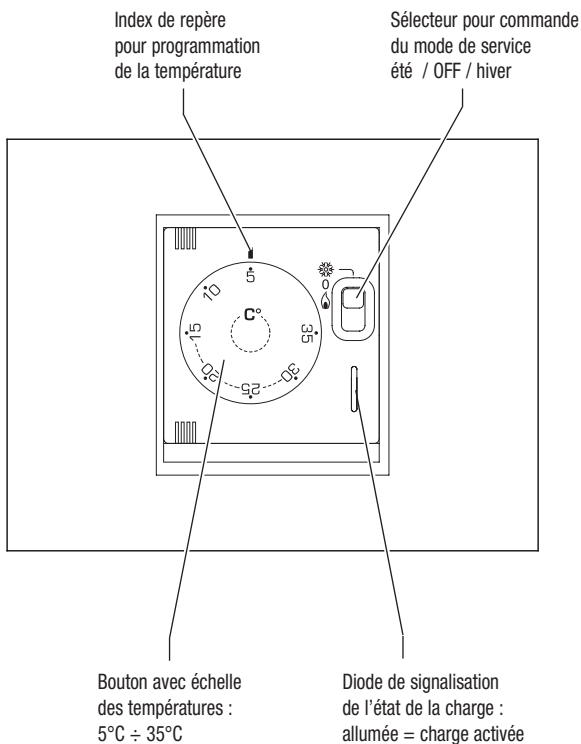

E S P A Ñ O L

Termostato electrónico verano/invierno

► **Atención - Importante**

Atención ! La seguridad de este aparato está garantizada solamente si se respetan meticulosamente todas las instrucciones aquí presentadas.

Cabe leer detenidamente estas instrucciones y guardarlas en un sitio seguro.

Los productos de la serie Chorus se pueden instalar en emplazamientos libres de polvo y donde no se exija una protección especial contra la penetración de agua.

Ellos tienen que ser instalados en conformidad con los requisitos para los aparatos para uso doméstico dictados por las normas y los reglamentos nacionales aplicables a las instalaciones eléctricas de baja tensión vigentes en el país donde se instalan los productos, o, si en dicho país no existen normas, en conformidad con la norma internacional para instalaciones eléctricas de baja tensión CEI 60364 o a la norma europea armonizada HD 60364.

La organización de ventas de Gewiss está a disposición para proporcionar aclaraciones y datos técnicos si se solicitan.

INDICE

DESCRIPCIÓN GENERAL DEL PRODUCTO	<i>pág.</i>
- Funciones.....	28
INSTRUCCIONES PARA LA INSTALACIÓN	
- Lógica aplicativa.....	29
- Conexión eléctricas	31
INSTRUCCIONES PARA EL EMPLEO	
- Mandos y señalizaciones	32

DESCRIPCIÓN GENERAL DEL PRODUCTO

Funciones

DATOS DE LAS PRESTACIONES

Función verano / invierno.

Señalizaciones luminosas:

- Led amarillo función de localización.
- Led verde indicación estado salida (acceso contacto NA cerrado).

DATOS TÉCNICOS

Tensión de alimentación:	230 V~ 50÷60 Hz
Potencia absorbible:	2VA
Tipo de salida:	mediante relé con contacto NA/CON/NC 8 A / 250 V~
Conexiones usuario (carga):	2 o 3 conductores
Sección máxima de los hilos en los bornes:	2,5 mm ²
Tipo de aislamiento:	Clase II 
Grado de protección:	IP 30
Polución:	Normal
Campo de regulación:	de +5°C a +35°C
Diferencial térmico:	1°C
Límites de la temperatura de funcionamiento:	0°C ÷ +50°C
Normas de referencia para marca CE:	
EMC EN55014-1 EN55014-2 EN61000-3-2 EN61000-3-3	
LVD EN60730-1 EN60730-2-9	
(Directrices 2006/95/CE - 2004/108/CE)	

INSTRUCCIONES PARA LA INSTALACIÓN



Logica aplicada

OK

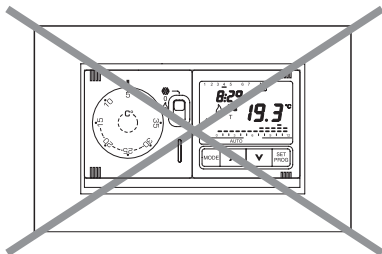
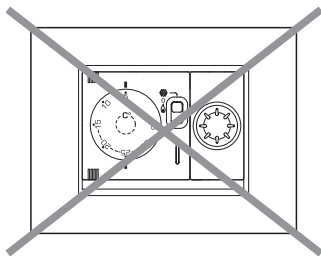
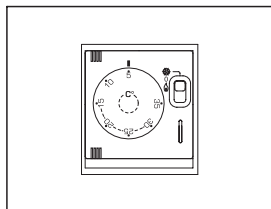

INSTRUCCIONES PARA LA INSTALACIÓN

Logica aplicativa

Consejos para la colocación:

Instalar el termostato en cota $1,50 \div 1,70$ m desde el suelo, lejos de fuentes de calor, tomas de aire, puertas o ventanas. No instalar en paredes perimétricas.

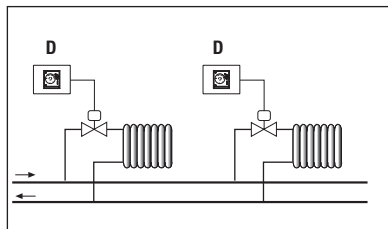
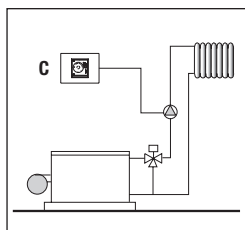
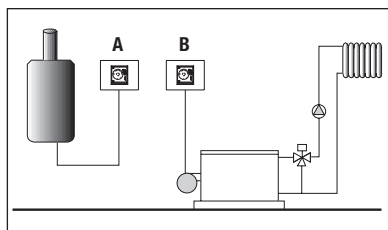
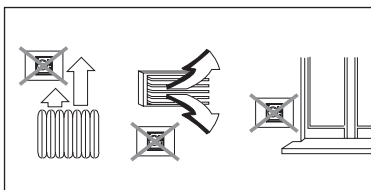
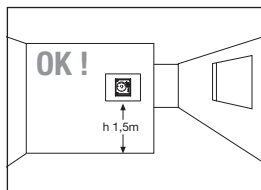

Instalaciones de calefacción con termostato que dirige:

- A Caldera mural
- B Quemador
- C Bomba de circulación
- D Electroválvula de zona

NOTA: Los ejemplos incluidos en la siguiente documentación son de principio

INSTRUCCIONES PARA LA INSTALACIÓN

Conexiones eléctricas

Importante: la instalación y la conexión eléctrica de los dispositivos y equipos tienen que ser llevados a cabo por personal cualificado y según las normas y leyes en vigor. El fabricante no se asume ninguna responsabilidad en lo que concierne al empleo de productos que requieran particulares normas de ambiente y/o instalación, cuya responsabilidad corre a cargo del instalador.

Atención: antes de efectuar la instalación del aparato, hay que desactivar la tensión de red.

Con la tensión de red desactivada:

Conectar los cables de alimentación a las bornas n° L (Línea) y n° N (Neutro).

Conectar a las bornas los cables del dispositivo a controlar:

n° 1 = contacto NA

n° 2 = común

n° 3 = contacto NC

Con fuertes cargas inductivas (bombas y electroválvulas) se aconseja conectar un filtro RC en paralelo respecto a la carga.

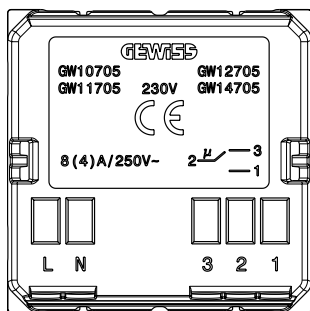

Bornas de cableado

Alimentación: L - Fase
N - Neutro

Relé de salida: 1 = contacto NA
2 = común
3 = contacto NC

INSTRUCCIONES PARA EL EMPLEO

Mandos y señalizaciones

Aguja indicadora
de referencia
para fijación temperatura

Selector para regulación
modo de trabajo
verano / OFF / invierno

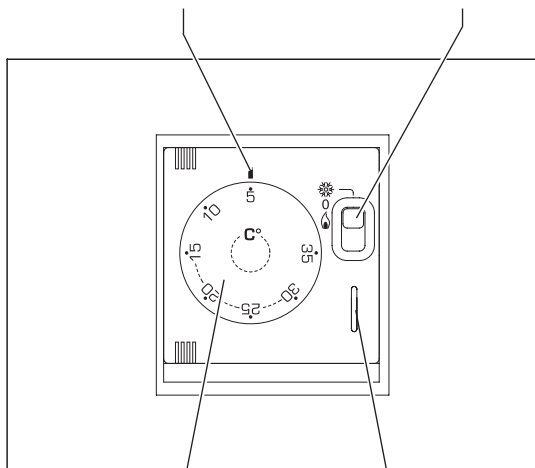

Manecilla con escala
temperaturas: 5°C ÷ 35°C

Led señalización estado
de la carga:
encendido = carga activada

D E U T S C H

Elektronischer Thermostat sommer/winter

► Achtung - Wichtig

Achtung ! Die Gerätesicherheit wird nur gewährleistet, wenn diese Anweisungen strikt eingehalten werden. Diese Unterlagen sorgfältig durchlesen und sicher aufbewahren.

Die Produkte der Baureihe Chorus können in staubfreier Umgebung installiert werden, in der kein spezieller Schutz gegen das Eindringen von Wasser notwendig ist.

Sie müssen in Übereinstimmung mit den Vorschriften für Haushaltsgeräte installiert werden, die durch im Installationsland geltenden Normen und Bestimmungen für Niederspannungsanlagen geregelt werden. Falls solche nicht vorgesehen sind, muss man die internationale Norm für Niederspannungsanlagen, IEC 60364, oder den Europäischen Harmonisierungsdokument HD 60364 beachten.

Für genauere Informationen und technische Daten wenden Sie sich bitte an den Vertrieb von Gewiss.

INHALTSVERZEICHNIS

ALLGEMEINE CHARAKTERISTIKEN DES PRODUKTES	<i>Seite</i>
- Funktionen	36
 INSTALLATIONSANLEITUNG	
- Anwendungslogik	
37	- Elektrische Anschlüsse
39	
 BETRIEBSANLEITUNG	
- Bedienelemente und Anzeigen	40

Funktionen

LEISTUNGSDATEN

Funktion Sommer / Winter.

Leuchtanzeigen:

- Gelbe LED Funktion Lokalisierung.
- Grüne LED Anzeige Zustand Ausgang (eingeschaltet Kontakt NO geschlossen).

TECHNISCHE KENNDATEN

Versorgungsspannung:	230 V~ 50÷60 Hz
Aufgenommene Leistung:	2VA
Ausgang über Relais mit Anschluss:	Schließer/Umschalter/Öffner 8(2)A / 250 V~
Geräteanschlüsse (Last):	2 oder 3 Leiter
Max. Querschnitt der Leiter an den Klemmen:	2,5 mm ²
Isolierung:	Klasse II 
Schutzgrad:	IP 30
Verschmutzung:	Normal
Regelbereich:	von +5°C bis +35°C
Hysterese:	1°C
Betriebstemperaturgrenzwerte:	0°C ÷ +50°C
Bezugsnormen für CE-Zeichen:	
EMC EN55014-1 EN55014-2 EN61000-3-2 EN61000-3-3	
LVD EN60730-1 EN60730-2-9	
(EWG-Richtlinien 2006/95/EG - 2004/108/EG)	

INSTALLATIONSANLEITUNG



Anwendungslogik

OK

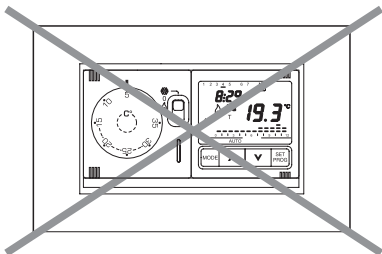
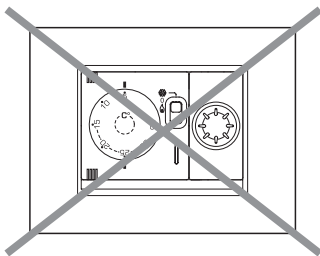
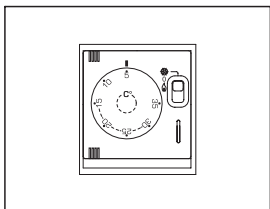

INSTALLATIONSANLEITUNG

Anwendungslogik

Hinweise zur Anbringung:

Der Thermostat in einer Höhe von $1,50 \div 1,70$ m über dem Boden in sicherem Abstand von Wärmequellen, Luftzug oder Fenstern installieren. Die Installation an Außenmauern ist verboten.

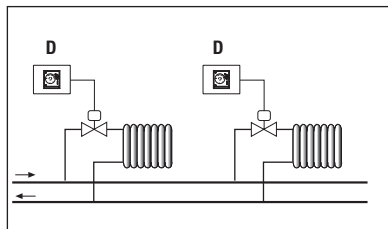
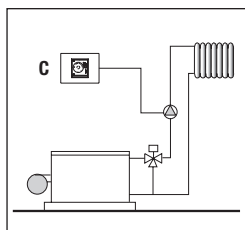
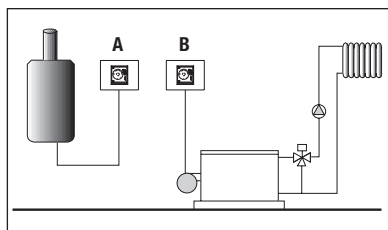
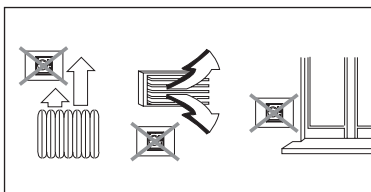
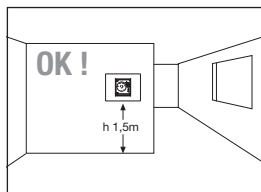

Heizungsanlagen mit Thermostat zur Steuerung von:

- A Wandbefestigten Heizkesseln
- B Brennern
- C Umwälzpumpen
- D Bereichsventilen

N.B.: Die in der folgenden Dokumentation dargestellten Beispiele dienen nur zur Orientierung.

INSTALLATIONSANLEITUNG

Elektrische anschlüsse

Wichtig: Installation und elektrischer Anschluss der Vorrichtungen und Geräte müssen von qualifiziertem Fachpersonal nach den geltenden Vorschriften und Gesetzen ausgeführt werden. Der Hersteller übernimmt keinerlei Haftung für die Verwendung von Produkten, die speziellen Umwelt- und/oder Installationsvorschriften unterliegen; dies liegt im Verantwortungsbereich des Installateurs und geht zu dessen Lasten.

Achtung: Vor der Installation des Geräts Netzspannung abschalten.

Bei abgeschalteter Netzspannung:

Die Adern der Versorgung an die Klemmen L (Phase) und N (Nullleiter) anschließen.

Die Adern des zu steuernden Geräts an folgende Klemmen anschließen:

Nr 1 = Kontakt NO

Nr 2 = Allgemein

Nr 3 = Kontakt NG

Bei hohen induktiven Lasten (Pumpen und Magnetventile) sollte ein RC-Filter parallel zur Last angeschlossen werden.

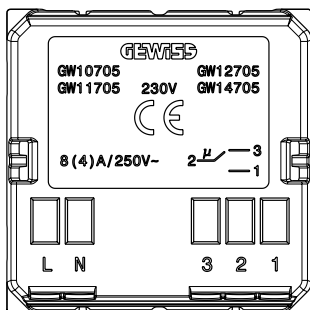

Verkabelungsklemmen

Stromversorgung : L - Phase
N - Nullleiter

Ausgangsrelais: 1 = Kontakt NO
2 = Allgemein
3 = Kontakt NG

BETRIEBSANLEITUNG

Bedienelemente und anzeigen

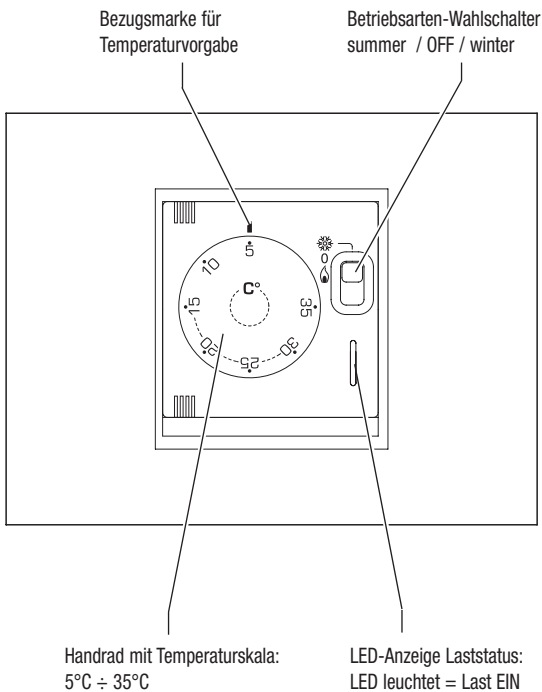

R O M Â N Ă

Termostat electronic vară/iarnă

▶ **Atenție - Important**

Atenție! Siguranța aparatului este garantată doar prin respectarea riguroasă a instrucțiunilor din prezentul manual. Prin urmare, citiți-le și asigurați-vă că le aveți întotdeauna la îndemână.

Produsele Chorus trebuie să fie instalate conform dispozițiilor normei CEI 64-8 privind aparatele de uz casnic și similare, în medii fără praf și în care nu este necesară o protecție specială împotriva pătrunderii apei.

Punctele de vânzare GEWISS vă stau la dispoziție pentru clarificări și informații tehnice.

DATE GENERALE PRODUS	<i>pag.</i>
- Funcții.....	44
INSTRUCȚIUNI DE INSTALARE	
- Logica aplicativă.....	45
- Conexiuni electrice.....	47
INSTRUCȚIUNI DE UTILIZARE	
- Comenzi și semnalizări.....	48

DATE GENERALE PRODUS

Funcții

DATE PRIVIND PERFORMANȚELE

Funcție vară / iarnă.

Semnale luminoase:

- LED galben funcție de localizare.

- LED verde de indicare a stării ieșirii (acces contact ND închis).

DATE TEHNICE

Tensiune de alimentare :	230 V~ 50+60 Hz
Puterea absorbită:	2VA
Contact de ieșire :	cu releu cu contact de schimb ND/COM/NÎ 8 A / 250 V~
Conexiuni utilizator (sarcină) :	2 sau 3 conductoare
Secțiunea maximă a firelor către terminale:	2,5 mm ²
Tip izolație:	Clasa II <input type="checkbox"/>
Grad de protecție:	IP 30
Nivel de poluare:	Normal
Plajă de reglare :	de la +5°C la +35°C
Diferențial termic:	1°C
Limite temperatură funcționare :	0°C ÷ +50°C
Standarde de referință pentru marcajul CE:	
EMC EN55014-1 EN55014-2 EN61000-3-2 EN61000-3-3	
LVD EN60730-1 EN60730-2-9	
(Directivele 2006/95/CE - 2004/108/CE)	

INSTRUCȚIUNI DE INSTALARE



Logica aplicativă

OK

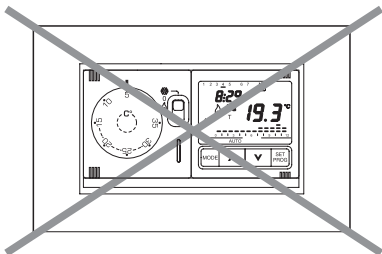
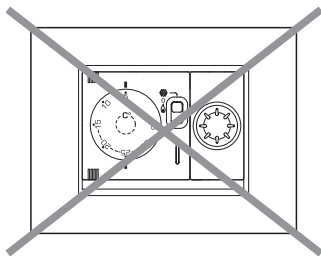
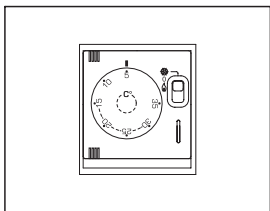

INSTRUCȚIUNI DE INSTALARE

Logica aplicativă

Sfaturi cu privire la amplasare:

Instalați termostatul la o înălțime de 1,50+1,70 m față de pardoseală, departe de surse de căldură, prize de aer, uși sau ferestre. Este interzisă instalarea pe pereți perimetrali.

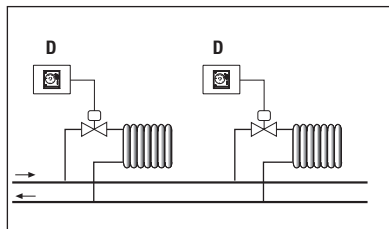
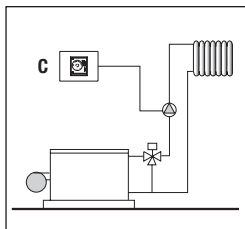
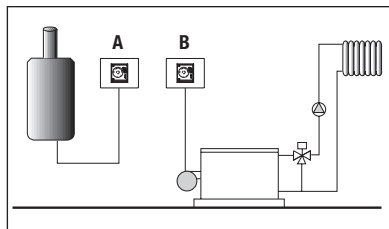
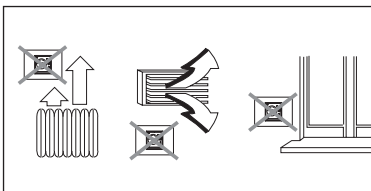
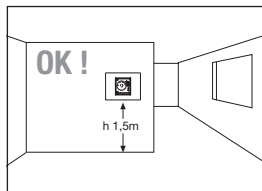

Sisteme de încălzire cu termostată de comandă pentru:

- A Centrală de perete
- B Arzător
- C Pompă de circulație
- D Electrovalvă de zonă

N.B.: Exemplele din documentul de mai jos sunt cu titlu ilustrativ

INSTRUCȚIUNI DE INSTALARE

Conexiuni electrice

Important: Instalarea și conexiunea electrică a dispozitivelor și aparatelor trebuie să fie efectuate de personal calificat și în conformitate cu normele și legile în vigoare. Producătorul nu își asumă nicio responsabilitate în ceea ce privește utilizarea produselor care trebuie să respecte anumite standarde de mediu și/sau de instalare, aceste obligații fiind în sarcina instalatorului.

Atenție: Înainte de a instala produsul, întrerupeți alimentarea cu energie electrică de la rețea.

După întreruperea alimentării:

Conectați firele de alimentare la terminalele L (Fază) și N (Nul).

Conectați firele dispozitivului care doriți să fie controlat la terminalele:

- 1 = contact ND
- 2 = comun
- 3 = contact NÎ

Cu sarcini inductive mari (pompe și electrovalve) se recomandă legarea unui filtru RC în paralel cu sarcina.

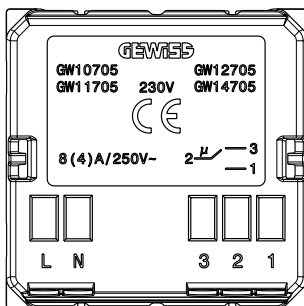

Terminale de cablare

Alimentare : L - Fază
N - Nul

Relev de ieșire: 1 - Contact ND
2 - Contact comun
3 - Contact NÎ

INSTRUCȚIUNI DE UTILIZARE

Comenzi și semnalizări

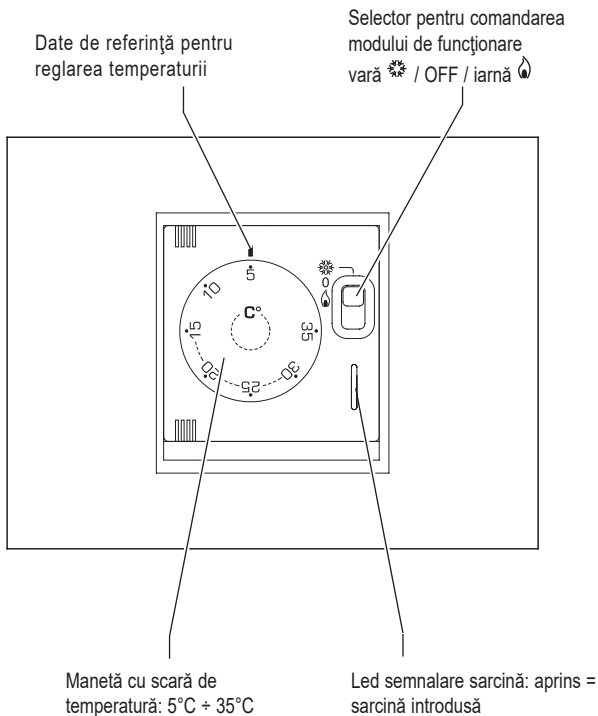

▶ **NOTE - NOTES - REMARQUES - REMARQUES - HINWEISE - NOTE**

Lined area for notes with horizontal dashed lines.

► **NOTE - NOTES - REMARQUES - REMARQUES - HINWEISE - NOTE**

▶ **NOTE - NOTES - REMARQUES - REMARQUES - HINWEISE - NOTE**

.....

.....

.....

.....

.....

.....

.....

.....

.....

.....

.....

.....

.....

.....

.....

.....

.....

.....

.....

.....

.....

.....

Punto di contatto indicato in adempimento ai fini delle direttive e regolamenti UE applicabili:
Contact details according to the relevant European Directives and Regulations:
GEWISS S.p.A. Via A.Volta, 1 IT-24069 Cesate Sotto (BG) Italy tel: +39 035 946 111 E-mail: qualitymarks@gewiss.com

According to applicable UK regulations, the company responsible for placing the goods in UK market is:
GEWISS UK LTD - Unity House, Compass Point Business Park, 9 Stocks Bridge Way, ST IVES
Cambridgeshire, PE27 5JL, United Kingdom tel: +44 1954 712757 E-mail: gewiss-uk@gewiss.com



+39 035 946 11

8:30 - 12:30 / 14:00 - 18:00

lunedì - venerdì / monday - friday



www.gewiss.com

