

PRODUCT DATASHEET

HIGH BAY VALUE 100 W 4000 K 100 DEG IP65 BK

HIGH BAY VALUE | High-bay luminaires up to 110 lm/W



Areas of application

- Replacement for high bay luminaires with mercury vapor or metal halide lamps
- Warehouses
- Logistics halls
- Industry
- High ceiling (e.g. in shopping malls, airports, commercial buildings, lobbies)

Product benefits

- Modern exclusive design
- Energy savings of up to 60 % compared to conventional high bay luminaires
- 3 years guarantee
- Optimized weight and size due to compact design

Product features

- Operating temperature: -20...50 °C
- Black aluminum housing, tempered glass cover
- Opal cover
- Type of protection: IP65
- Lifetime (L70): up to 50,000 h
- High luminous efficacy: up to 110 lm/W



TECHNICAL DATA

Electrical data

Nominal wattage	100.00 W
Nominal voltage	220...240 V
Mains frequency	50...60 Hz
Nominal current	450 mA
Inrush current	7.72 A
Inrush current time T_{h50}	3.4 μ s
Max. no. of lum. on circuit break. B16 A	28
Max. no. of lum. on circuit break. C10 A	17
Max. no. of lum. on circuit break. C16 A	28
Power factor λ	≥ 0.90
Total harmonic distortion	< 20 %
Protection class	I
Operating mode	Mains voltage

Photometrical data

Luminous flux	10000 lm
Luminous efficacy	100 lm/W
Color temperature	4000 K
Light color (designation)	Cool White
Color rendering index Ra	> 80
Standard deviation of color matching	< 5 sdc _m
Photobiological safety group acc. to EN62778	RG1
Photobiological safety group acc. to EN62471	RG1
Beam angle	100 °



LDC typ cone

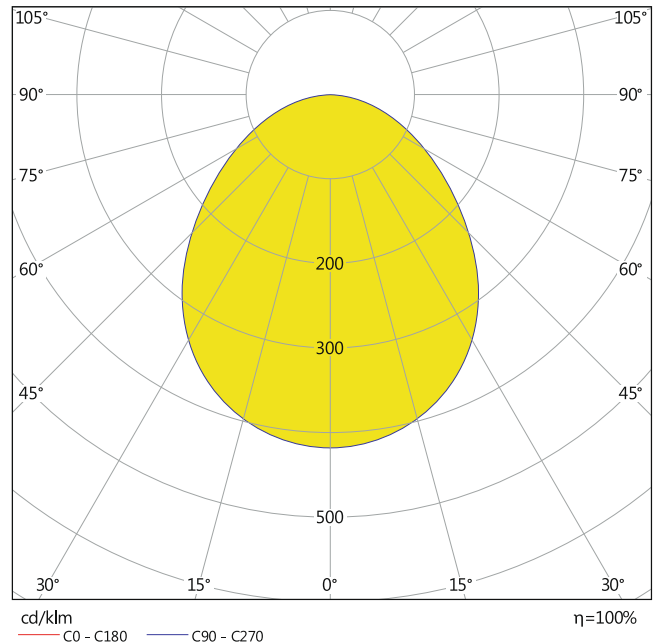

LDC typ polar

Dimensions & Weight

Diameter	230.00 mm
Height	51.40 mm
Product weight	1338.00 g
Cable length	500 mm

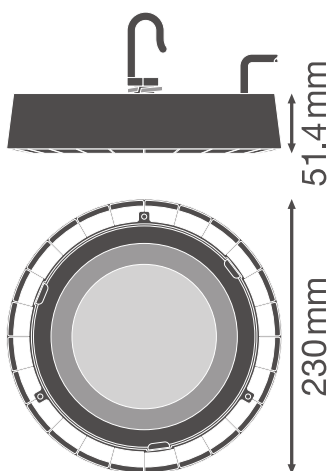

Materials & Colors

Product color	Black
Housing color	Black
Body material	Aluminum
Cover material	Tempered glass
Glow Wire Test according to IEC 60695-2-12	650 °C
Mercury content	0.0 mg

Application & Mounting

Ambient temperature range	-20...+50 °C
Type of connection	Cable, 3-pole
Type of protection	IP65
Protection class IK (shock resistance)	IK06
Dimmable	No
Mounting type	Suspended/Surface
Mounting location	Ceiling
Application environment	Indoor
LED module replaceable	Not replaceable
With light source	Yes

Lifespan

Lifespan L70/B50 at 25 °C	50000 h
Lifespan L80/B10 at 25 °C	32000 h
Number of switching cycles	50000











Certificates & Standards

Standards	CE / CB / EAC
Luminaire with limited surface temperature, "D sign"	Yes
Ball shot safe	No

EQUIPMENT / ACCESSORIES

– Bracket available

DOWNLOAD DATA

Documents and certificates	
	User instruction
	Packaging insert
	Declarations Of Conformity CE
Photometric and lighting design files	
	IES file (IES)
	LDT file (Eulumdat)
	ROLF file (RELUX)
	UGR file (UGR table)
	LDC typ cone
	LDC typ polar
CAD/BIM files	
	CAD_STEP_3D
Tender Texts	
	Tender documents

LOGISTICAL DATA

Product code	Packaging unit (Pieces/Unit)	Dimensions (length x width x height)	Gross weight	Volume
4058075408395	Shipping box 1	255 mm x 252 mm x 72 mm	1533.00 g	4.63 dm ³

The mentioned product code describes the smallest quantity unit which can be ordered. One shipping unit can contain one or more single products. When placing an order, for the quantity please enter single or multiples of a shipping unit.

ADDITIONAL CATALOG INFORMATION

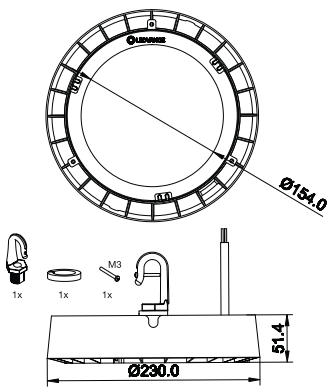

References / Links

- For Guarantee see www.ledvance.com/guarantee

DISCLAIMER

Subject to change without notice. Errors and omission excepted. Always make sure to use the most recent release.